

SSC-159

**ACQUISITION AND ANALYSIS OF
ACCELERATION DATA**

BY

**F. C. BAILEY
D. J. FRITCH
and
N. S. WISE**

SHIP STRUCTURE COMMITTEE

SHIP STRUCTURE COMMITTEE

MEMBER AGENCIES:

BUREAU OF SHIPS, DEPT. OF NAVY
MILITARY SEA TRANSPORTATION SERVICE, DEPT. OF NAVY
UNITED STATES COAST GUARD, TREASURY DEPT.
MARITIME ADMINISTRATION, DEPT. OF COMMERCE
AMERICAN BUREAU OF SHIPPING

ADDRESS CORRESPONDENCE

SECRETARY
SHIP STRUCTURE COMMITTEE
U. S. COAST GUARD HEADQUARTERS
WASHINGTON 25, D. C.

February 17, 1964

Dear Sir:

The development and performance testing of a magnetic-type data recording system in a current project of the Ship Structure Committee at Lessells and Associates, Inc., encouraged the Army Transportation Corps to utilize the equipment to develop information on extreme values of load conditions to which ship cargoes might be subjected while en voyage.

Herewith is a copy of the Third Progress Report, SSC-159, Acquisition and Analysis of Acceleration Data from the S. S. Wolverine State and Long-Term Prediction of Seaway Induced Loads on Cargo by F. C. Bailey, D. J. Fitch and N. S. Wise.

This phase of the project was conducted under the advisory guidance of the Committee on Ship Structural Design of the National Academy of Sciences-National Research Council.

Please address any comments concerning this report to the Secretary, Ship Structure Committee.

Sincerely yours,



T. J. Fabik
Rear Admiral, U. S. Coast Guard
Chairman, Ship Structure Committee

SSC-159

Third Progress Report
of
Project SR-153
"Ship Response Statistics"

to the
Ship Structure Committee

ACQUISITION AND ANALYSIS OF
ACCELERATION DATA

by

F. C. Bailey
D. J. Fritch
and
N. S. Wise

Lessells and Associates, Inc.
Waltham 54, Massachusetts

under

Department of the Navy
Bureau of Ships Contract NObs-88451

Washington, D. C.
National Academy of Sciences-National Research Council
February 17, 1964

CONTENTS

	<u>Page</u>
Summary	1
Conclusions and Recommendations	1
Introduction	4
Objectives	5
Theoretical Considerations	6
Description of Vessel and Data Acquisition System	16
Description of Data Reduction System and Methods of Analysis	28
Results of Analysis	35
Discussion of Results	48
Acknowledgements	56
References	56
Appendix A -	
Detailed Specifications of Data Acquisition System Components	57
Appendix B -	
Detailed Specifications of Data Reduction System Components	59
Appendix C -	
Sea State Numbers Corresponding to Beaufort Wind Scale	63

NATIONAL ACADEMY OF SCIENCES-NATIONAL RESEARCH COUNCIL
Division of Engineering & Industrial Research

SR-153 Project Advisory Committee

"Ship Response Statistics"

for the

Ship Hull Research Committee

Chairman:

C. O. Dohrenwend
Rensselaer Polytechnic Institute

Members:

J. P. Den Hartog
Massachusetts Institute of Technology

N. H. Jasper
U. S. Naval Mine Defense Laboratory

E. V. Lewis
Webb Institute of Naval Architecture

R. L. McDougal
Lockheed Aircraft Corp.

Wilbur Marks
Oceanics, Inc.

I. SUMMARY

As part of a broad investigation with the objective of developing information on extreme values of load conditions to which cargo might be subjected, seven accelerometers and an unmanned recording system were installed aboard a dry cargo vessel on regular North Atlantic service, and data were obtained over a period of 15 months. The immediate purpose was to establish the basis for prediction of extreme values of acceleration which would be encountered by cargo in the vessel over long periods of time.

The data acquisition system operated satisfactorily for slightly less than 14 of 15 round-trip voyages, or an efficiency of approximately 90%. Analysis was based on data accumulated for 30 minutes every four hours representing a total of over 8000 hours of ship operating time of which 6200 hours were in the open ocean.

Analysis of wave-induced accelerations using a special purpose probability analyzer resulted in a maximum observed acceleration (bow, vertical) of 1.76 g's peak-to-peak. This value is within 6% of the predicted value for the same circumstances. Slamming or pounding combined with other phenomena resulted in higher frequency accelerations (in the range of 10 cps) in excess of 3.0 g's peak-to-peak. Contrary to expectations, the peak accelerations observed under conditions of "slam" or "pound" were largely the result of hull vibrations of a high mode, and were apparently excited in part by the second order of propeller blade excitation.

While the maximum accelerations from "slams" and maximum wave-induced accelerations occur in the same time interval or under the same sea conditions, these maxima are not in general additive since the slam-induced maxima tend to occur when the wave-induced accelerations are approaching zero.

It is presently possible to make only general recommendations relative to control of cargo loads since this investigation is limited to a single ship-type and route. Additional analysis of the higher frequency components present in the recorded data as well as extension of the study to other ship-types and routes is needed. Consideration must also be given to the use of model tests in predicting wave-induced accelerations; the development and application of more general statistical methods for handling long-range predictions of both wave-induced and higher frequency accelerations; and the eventual use of simpler and less expensive shipboard instrumentation which would yield data requiring little subsequent reduction prior to analysis.

II. CONCLUSIONS AND RECOMMENDATIONS

A. Conclusions

On the basis of the investigation reported herein, the following conclusions seem justified:

1. The acquisition of acceleration data on ships at sea can be readily accomplished with good reliability using the instrumentation developed under this program.
2. The probability analyzer cuts data reduction time and costs by several orders of magnitude compared to manual techniques especially as regards wave-induced acceleration data. The performance of the analyzer was up to all expectations.
3. The largest value of wave-induced acceleration (excluding slam or any other effect) observed during the 15 months of this investigation was 1.76 g's peak-to-peak. This occurred on the bow vertical accelerometer.
4. Log-normal plots of the data from all seven accelerometers indicate that the bow vertical accelerations were most severe followed closely by the transverse and the stern vertical accelerations. Fore-and-aft accelerations were the least severe. Since the bow vertical accelerations were also severe for slam and other effects, the bulk of the analysis was focussed on the bow vertical data.
5. A combination of slam or pound along with some resonances in the vessel resulted in a maximum observed non-"wave-induced" acceleration in excess of 3.0g's peak-to-peak on the bow vertical accelerometer. Even though these signals in general had an initial spike indicative of slam or pound, it was found that a major component of the signal occurring at about 10 cps is probably induced by the second order of the propeller blade excitation. In some cases, the stern vertical accelerometer showed initial spikes slightly larger than the bow vertical accelerometer.
6. Whipping apparently did not generate accelerations of substantial magnitude compared to the other components.
7. Using the log-normal plot, simple but conservative extrapolations of the wave-induced accelerations are possible. On this basis, the most probable maximum bow vertical wave-induced acceleration to be expected by this vessel on this route over a seven-year operating span would be 2.97 g's peak-to-peak. Less conservative but more general predictions are possible using machine computation techniques. For the fifteen month period studied, the observed maximum and predicted most probable maximum agree to within 6% on the basis of data acquisition for 30 minutes out of every four hours.
8. The prediction of maximum slam induced accelerations over long periods of time is complicated by the presence of other components in what appears to be the slam acceleration signals. Lack of time prevented detailed analysis of the statistical nature of this data. The consistent increase in the average of the observed maximum peak-to-peak levels with sea state and the distribution of the maxima for each sea state, lead to the conclusion that the data would be amenable to orderly analysis.

9. Based on the results of the statistical accelerometer study, which in some respects was not completely satisfactory, there would appear to be little difference in vertical accelerations in forward cargo spaces near the bottom or near the deck. Further confirmation of this conclusion is desirable, however.

10. Even though the largest "slam" accelerations occurred during the intervals of largest wave-induced acceleration, the two acceleration components are not necessarily directly additive. The burst occasioned by the slam and other excitation occurred as the wave-induced acceleration was less than half of the maximum value of the cycle.

11. It is now possible to make general recommendations relative to mitigation of cargo loads likely to be encountered, but the basis for such statements is limited by the fact that experience has been confined to a single ship-type and route.

B. Recommendations

Based on the investigation to date, and directing attention at the overall objectives of the study, the following are recommended:

1. Investigations similar to those described herein must be pursued, both as regards the study of available data and the acquisition of additional data on other vessels and routes, to permit the development of valid solutions to the general problem of assuring efficient and effective transportation at sea.
2. The higher frequency acceleration components observed on the WOLVERINE STATE records should be subjected to detailed scrutiny to establish, insofar as possible, the origins of the excitation and the relative influence at different locations in the ship.
3. Future shipboard installations should include as a minimum accelerometers triaxially mounted at the bow, and vertical and transverse accelerometers amidships and at the stern. It is felt that the data of primary interest will be developed by the bow accelerometers. However, vessel resonances and modes of excitation other than the sea seem to contribute substantially to the peak accelerations. The inclusion of the midship and stern installations will permit determination of the simpler vessel mode shapes and may help in locating the source of some of the excitation.
4. At least two additional ship types should be instrumented and data collected for at least 18 months on each. It is recommended that a C-4 "Mariner"-type (or other high-speed dry cargo ship) and a "Victory"-type be selected. Care should be taken to insure that the instrumentation aboard these vessels will permit reliable analysis of higher frequency acceleration components as well as wave-induced.
5. The use of model tests to predict full scale wave-induced accelerations should be explored.

6. The use of the methods of Lewis and Bennet, relative to generalized long-term extrapolation, should be fully explored with emphasis on application to the data now in hand.
7. Statistical methods for use in handling the non-wave-induced data must be developed and confirmed.
8. Serious consideration should be given to the use of instruments which record only the two or three largest values of a signal during a specified interval. This could be done immediately with confidence on wave-induced data, but the anomalies encountered to date in slam and related data indicate that more study may be required in this area before such a simplified system could be adopted.

III. INTRODUCTION

The Office of the Chief of Transportation has, for some years, been engaged in a broad program to establish the shock and vibration environments to which cargo is subjected in all modes of transportation. The ultimate goal is to develop methods whereby the environments encountered during movement of material can be integrated into the overall logistical problem. The motivation is based partly on the damage suffered by conventional cargo shipped by conventional means. A more pressing requirement is generated by the necessity for shipping sensitive cargoes large distances using a variety of vehicles, and having positive assurance of efficient and effective transportation.

There is a large variety of methods whereby cargo can be packaged to offer protection during shipment. In order to provide adequate protection against shock and vibration, it is necessary however, that the characteristics of the environment be known and be capable of quantitative mathematical expression within reasonable limits. The design of suitable packaging then becomes a straightforward engineering problem with one noteworthy reservation which will become apparent in the discussion to follow.

Two basic problems exist in the broad study of transportation shock and vibration environments. The first of these has to do with the extreme breadth of amplitude and frequency encountered as one moves from rail to truck to aircraft to ship. The excitation frequencies range from less than 0.25 cycles per second to more than 1,000 cycles per second.^{(1)*} A subsidiary problem follows immediately from the first and, of course, has to do with the design complications introduced by such a wide range of environmental factors. However, this problem, while not insoluble, is beyond the scope of the present investigation.

The second problem is that of establishing, from a relatively small number of measurements, a satisfactory "design" environment. Such a design basis would presumably take into account the most

* See List of References, Section XI.

severe conditions or combinations of conditions likely to be encountered, or would permit extrapolation to some extreme condition on the basis of a selected probability of occurrence. With some media (rail, highway), it is conceivable that the extreme conditions can be simulated during test runs. This is only partly the case with aircraft. With ships, where the environment is statistical in nature and short term, controlled tests are out of the question.

Prior to the inception of the work reported herein, studies had been undertaken on highway vehicles, railroad vehicles, and aircraft. The approach to establishing shock and vibration environmental characteristics for these modes has, in general, consisted of controlled experiments combined with acquisition of some statistical shock and vibration data over longer intervals. In reviewing the problem of shipboard cargo loadings induced by motion of the ship, it became apparent that the problem, in some aspects, was increased by several orders of magnitude. However, at this point in time, it was observed that the understanding of the characteristics of the seaway was increasing rapidly and that work was already underway on measurement of seaway induced bending moment loads on merchant ships with a view to establishing extreme values over long periods of operation(2). The work undertaken in the present study was performed in conjunction with these measurements, using the same basic recording and analysis technique. As a consequence, considerable lead time, otherwise required for the development of recording instrumentation, was saved. The balance of this report will present the details of the recording and analysis systems, present the results of analyses of data from 16 months of ship operation in the North Atlantic, and present comments relative to solution of the basic problem of establishing the extreme cargo environment at sea and to the acquisition of data on other ship-types and trade routes.

IV. OBJECTIVES

The objectives of this program are:

A. To record and analyze seaway induced accelerations at representative locations on a dry cargo vessel over a long period of time with a view toward establishing extreme values of accelerations which might be encountered by the vessel.

B. To characterize the above acceleration data in terms which will be of direct assistance in predicting extreme values of load conditions to which cargo would be subjected.

As used herein, seaway induced accelerations include those resulting from passage of the ship through waves (wave induced) and those resulting from "slamming", or the impact of the fore-foot of the vessel on the surface of the water such as may occur during rough weather.

V. THEORETICAL CONSIDERATIONS

A. General

Some characteristics of the acceleration data to be discussed in later sections of this report are easily fitted to convenient, if empirical, mathematical expressions. This is particularly true of wave induced accelerations. In any case, some understanding of the nature of the basic quantities being studied is helpful, even though not all of the material presented in this section will necessarily be applied in later sections.

It is not the intention in this report to perform complete derivations of the statistical basis for the reduction, analysis, and extrapolation of the acceleration data. However, in summarizing the theoretical aspects, it is quite necessary that the present state of the art be placed in proper context since the basis for many of the analytical techniques is good, but has not been proven to be exact.

The discussion to follow will be divided into sections covering wave induced accelerations, slamming and pounding accelerations, and acceleration data as applied to cargo loads. As noted in the previous section, wave induced accelerations are those resulting from the passage of the ship through waves, and exclude those caused by slamming, pounding or whipping*.

Figure 1 illustrates the separation of wave induced and slamming or pounding acceleration components. It is apparent that the cargo will be subjected to slamming, whipping, and wave induced accelerations, and that a faithful record will show these acting simultaneously. However, there are a number of reasons for separating these components for analytical purposes and then recombining the results to deduce the maximum cargo loadings to be expected over long periods at sea. Among these are:

1. Slamming and pounding result in a very high frequency, high amplitude "spike," followed by whipping of the hull at a frequency on the order of ten times the

* For the purpose of this report, these terms will be defined as follows:

Slamming: The impact of the fore-foot of the vessel with water after the bow has left the water. Slamming also can occur on vessels having large bow flare without having the fore-foot leave the water. As used in the report, the term "slamming" should be interpreted to include pounding.

Pounding: The impact of waves on the vessel while all portions of the bottom are immersed.

Whipping: Bending vibration of the hull in the two-noded mode, either vertically or horizontally such as may be excited by slamming or pounding.

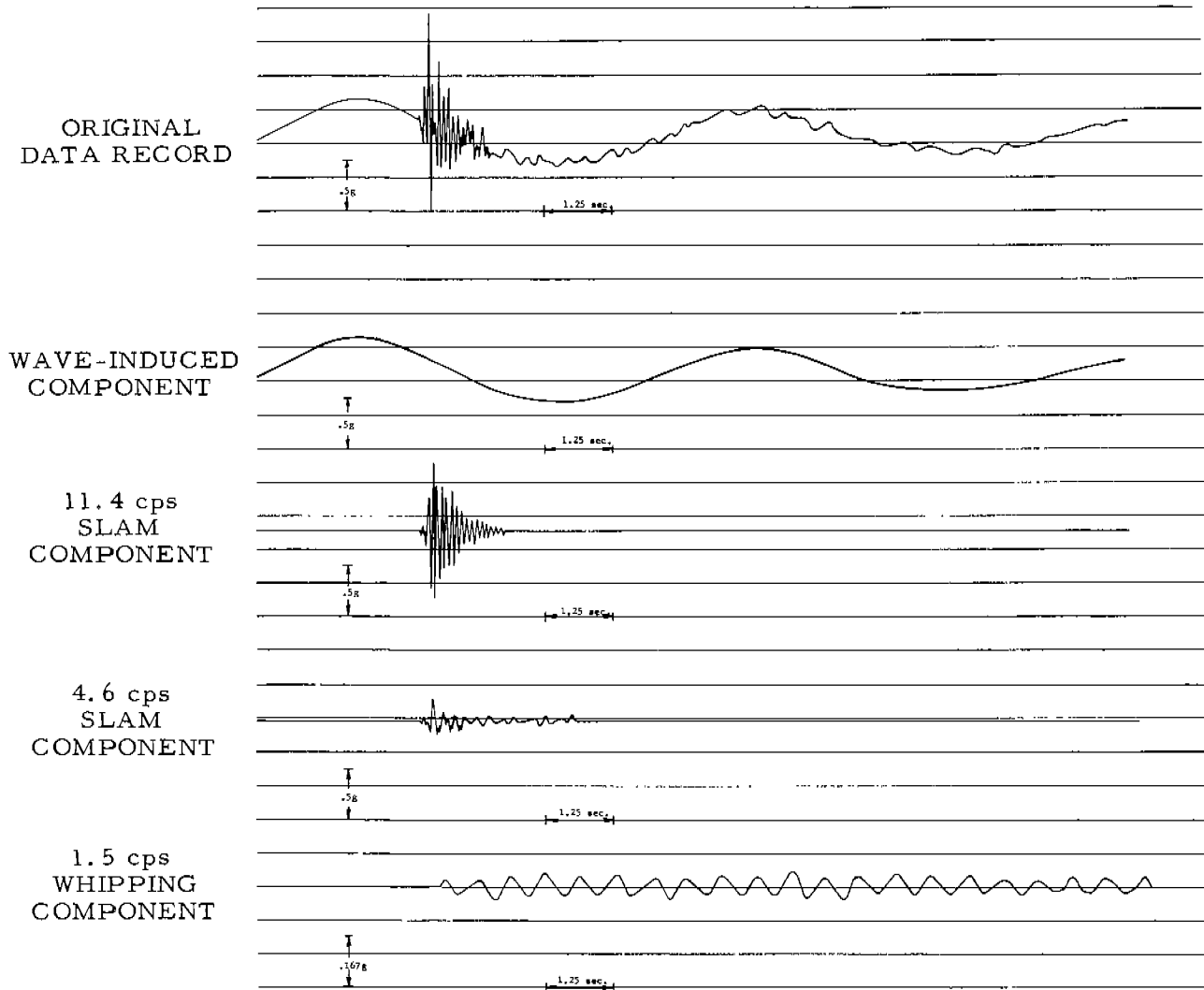
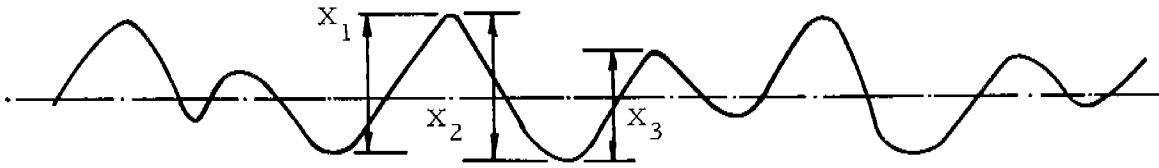

FIG. 1. TYPICAL ACCELERATION WAVEFORM SHOWING WAVE-INDUCED, SLAMMING OR POUNDING, AND WHIPPING COMPONENTS.

frequency of the wave induced acceleration. The effects of each of these three components, because of their very different characteristic frequencies, must be considered in cargo loading studies.

2. The wave induced accelerations appear to lend themselves better to orderly statistical analysis, both in the short term and the long term. Since they represent the bulk of the data, simplified automatic techniques can be utilized to minimize the analysis task.

3. Slamming, pounding, and whipping occur during the periods of most severe seaway induced accelerations. Independent extrapolation of each component to obtain extreme values, which can then be judiciously recombined, will therefore not result in an excessively conservative overall maximum value of acceleration. Caution must



$X_1, X_2, X_3 =$ PEAK-TO-PEAK VARIATIONS

FIG. 2. SECTION OF TYPICAL DATA RECORD ILLUSTRATING PEAK-TO-PEAK VARIATIONS.

be exercised in the combination, however, since slamming occurs closer to the time of zero wave induced acceleration than to the time of the maximum, for instance.

B. Wave Induced Accelerations

1. General

The discussion to follow relative to long-term and short-term data is based largely on the work of Jasper^(3,4) and Bennet^(5,6). The presentation will be based on consideration of peak-to-peak acceleration variation, x , (the vertical distance from crest to adjacent trough or trough to adjacent crest on an oscillographic record of acceleration signals). See Figure 2. Similar arguments can be used if the analysis is to be based on acceleration amplitudes (the vertical distance from mean to crest and mean to trough).

All of the mathematical models applied to the statistical analysis of wave induced accelerations in ships are identical to those used in describing wave systems (7). This is based on the theoretically reasonable, and increasingly well documented, assumption of linear dependence of acceleration on wave height. Most of the basic theory has therefore been the fruit of the oceanographer's efforts, but can be applied to wave induced ship response (bending moment, acceleration, motions, etc.) with equal assurance^(3,4,5).

In dealing with the statistical description of ocean waves, it is convenient first to confine the analysis to a given wave system, i. e., a specified wind generated sea. The statistical presentation of peak-to-peak wave height variation can be thought of either as representing the variation at a certain point at different times in a specified (short) interval, or the distribution of peak-to-peak variations at a given instant in an area of the ocean where wind direction and strength are constant. In treating acceleration in a similar manner, it is necessary to add that direction and speed of the vessel must be constant as well as the wave system. The acceleration data thus treated will be referred to as "short-term data." Data which embrace a variety of ship speeds, headings relative to the sea and/or wind, and sea states, will be considered "long-term data." The statistical basis for dealing with long-term data is more empirical than for short, but generally no less satisfactory on the basis of investigations to date.

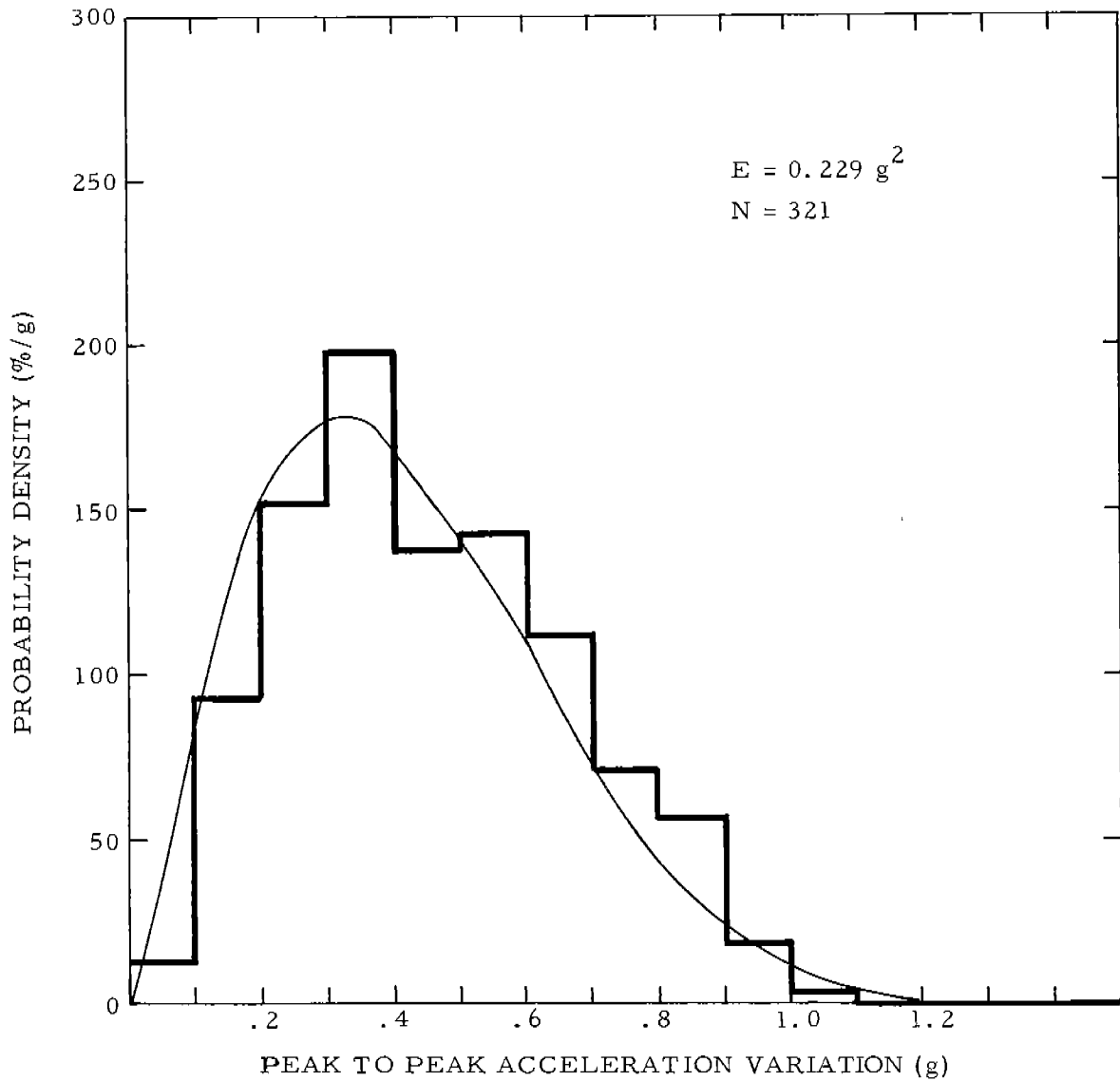

FIG. 3. TYPICAL ACCELERATION HISTOGRAM AND CORRESPONDING RAYLEIGH DISTRIBUTION.

For the purposes of this investigation, data obtained during a single recording interval (minimum of 30 minutes) will be assumed to qualify as "short-term data."

2. Short-Term Data

Figure 3 and equation 1 represent the basic Rayleigh distribution:

$$p(x) = \frac{2x}{E} e^{-\frac{2x}{E}} \quad x \geq 0 \quad (1)$$

where

$p(x)$ = probability density of x
 x = the magnitude of a data sample (peak-to-peak acceleration variation)
 $E = \frac{\sum x^2}{N}$
 N = number of samples

The above expression for E assumes that all values x are considered independently in the calculation of the mean square value of the variation. A more practical method of calculating E is to group the data samples into ranges of amplitude. The samples which fall in each range are then considered to have a magnitude equal to the mean value of the range into which they fall. Then,

$$E = \frac{\sum n_i x_i^2}{N}$$

where

x_i = the mean value of the i th range
 n_i = the number of data samples which fall within the i th range
 N = the total number of samples = $\sum n_i$

The Rayleigh Distribution is a single parameter distribution since when E is known, the complete distribution can be established. This is the basic expression to be used in analysis of short-term data with the following points in mind:

1. It is known that acceleration (and sea) data do not exactly fit the Rayleigh distribution, nor is there a reason why they should.
2. The departure from the Rayleigh curve is slight.
3. A large amount of wave height and ship response data show good agreement with equation (1).

In connection with the last comment above, it should be noted that the agreement becomes progressively less satisfactory at large values of the variate for which proportionately less information is available. There thus appears to be every reason to justify the use of the Rayleigh function in the analysis of acceleration data as long as the agreement is satisfactory and/or until an equally satisfactory distribution (from the point of view of simplicity and ease of manipulation), which fits the data better is developed.

The cumulative distribution of (1) is given by:

$$P(x) = 1 - (e)^{-\frac{x^2}{E}} \tag{2}$$

where

$P(x)$ = Probability of the variation being less than x in the time interval.

The most probable maximum value (x_{\max}) in a sample of N variations (7) is:

$$x_{\max} = \sqrt{E \ln N} \quad (3)$$

when N is large. For all samples to be considered in this investigation, this will be the case.

3. Long-Range Predictions

To have practical significance in cargo packaging design, it is apparent that time intervals will have to be considered which are far greater than the relatively short periods for which any given Rayleigh distribution will apply. A number of approaches to the prediction of long-range extreme values have been suggested; three will be considered here.

The first of these is proposed by Jasper⁽³⁾. He suggests, on the basis of data on waves and on ship response, that the log-normal distribution satisfactorily represents long-range ship response. Data from a variety of operating conditions for a given vessel seem to fit this distribution well, but a fundamental difficulty exists. If the distribution is to be developed on the basis of about one ship year of operation, a total of more than a million counts would have to be stored and evaluated.

A simpler method uses the mean square values from a number of short-term distributions as the basic units in developing a long-term distribution⁽⁴⁾. Studies to date indicate that a long-term collection of mean square values of stress variation and ship motion seem to follow the normal or log-normal distribution with a better fit to the log-normal. It is therefore possible to plot the E values and, using appropriate risk factors and estimating the ship operating life, an "extreme" value of E is determined. From this E, the most probable maximum value can be established on the basis of an assumed or calculated period of time during which the extreme conditions exist.

A number of variations on this approach are discussed by Bennet and Jasper in (4). The variations have been applied to the prediction of extreme value of stress or bending moment; in all cases, the E values for a long period are compared to a log-normal distribution. The log-normal distribution is, of course, a two parameter distribution and can be described in terms of the mean value of the logarithms of the values in the sample and the standard deviation of the logarithm. Since, in practice, the rms value of E is commonly used, the probability density would be given by (4).

$$p(\sqrt{E}) = \frac{1}{\sigma\sqrt{2\pi}} (e)^{-\frac{(\log \sqrt{E} - \mu)^2}{2\sigma^2}} \quad (4)$$

μ = mean value of $\log \sqrt{E}$

σ = standard deviation of $\log \sqrt{E}$

It has been observed that the fit of experimental data to the log-normal distribution becomes progressively poorer as the value of the variate becomes high. This could be explained on the basis of the meager amounts of data in this region, but there probably are more fundamental reasons why extrapolation of the log-normal distribution to very long ship operating times will result in the prediction of excessively high values of the variate. The principal of these is the fact that the distribution does not necessarily recognize the fact that the sea itself is physically self-limiting even under the most extreme conditions of wind, and that the combination of ship and sea may behave quite differently at extreme wave lengths and heights.

In summary, the following can be said regarding the Rayleigh and log-normal distributions:

1. Environmental conditions (wave system, ship speed and heading, wind speed and direction, etc.) are assumed constant during each thirty minute interval that data are being collected.
2. A Rayleigh distribution satisfactorily characterizes the distribution of acceleration levels in each recording interval.
3. Low frequency seaway induced accelerations only can be considered; slamming and whipping stresses are excluded from these particular analyses.
4. The log-normal distribution of E for a given ship on a given route is specifically applicable only to that ship (or ship-type) and route, and assumes that the data cover a truly representative sample of weather conditions on the route.

Another method of handling long-range predictions has been proposed by Lewis and Bennet⁽⁸⁾. Their method overcomes the fundamental disadvantage of the log-normal plot in that it is completely empirically based and therefore the extrapolation depends only on the reliability of the data at the extremes. A brief description of their method follows:

The first step involves a comparison of the accumulated data on a variable (stress, motion, acceleration) with sea state. This is accomplished by comparing the root-mean-square value (\sqrt{E}) for each recording interval with the sea state for that interval. It is observed that a number of \sqrt{E} values are found for each sea state; that the \sqrt{E} values are normally distributed for each sea state; and that the average curve of \sqrt{E} versus sea state is approximately linear. It is then possible to deduce a probability of occurrence for the value of the variate, x, for the given trade route by combining three probabilities:

- (a) The observed probability of occurrence of a given sea state on that route,
- (b) The observed normal distribution of Rayleighian acceleration distributions corresponding to this sea

state, and

(c) The probability of given peak-to-peak acceleration values occurring in the Rayleigh distributions.

These computations are best undertaken on a machine programmed for the purpose. The important point relative to the result, which is a plot of peak-to-peak value of the variate versus probability of exceedance, is that the behavior of a vessel can be predicted on any route as long as the distribution of sea states is known on the route and ship performance data have been related to sea state on at least one other route.

It can be seen that all of the techniques for long-range prediction are more or less complicated, and even though they all may be useful qualitatively, some serve better than others for precise long-range prediction. In the analysis of data in later sections, use will be made of several of these methods depending upon the objective of the particular analysis.

C. Slamming and Pounding Accelerations

At the present time, there is no particular statistical basis for the assessment of the effects of slamming or pounding on a vessel. An attempt will be made, therefore, for those recording intervals where slamming occurs to relate both the number of slams and the maximum and second largest peak-to-peak slamming acceleration to sea state. If the data sample is sufficiently large, it should then be possible to use statistical techniques to establish the anticipated maximum values.

D. Application of Acceleration Data to Prediction of Cargo Loads

It is not the purpose nor the intent of this report to develop the theory of shock and vibration isolation in detail, but some description of these problems is in order. Two distinct problems must be recognized in the application of acceleration data to the prediction of cargo loads. These are the isolation of the cargo from motions of the ship, and the protection of first units in a stacked cargo from the full inertia load of the entire stack.

First, consider an item of cargo supported by spring-damper mounts. An idealized single-degree-of-freedom system is shown in Figure 4. The curve of amplitude response ratio, i. e., transmissibility, illustrates several interesting features of this idealized system. At low frequencies, the motion of the mass (cargo) follows the motion of the base (deck) exactly. At high frequencies, the response is attenuated by a factor which is determined by the amount of system damping present. At resonance, the response of the system is magnified by a factor which is related to the system damping. In a typical shipboard situation it would appear best to fasten the cargo directly to the deck if low frequency wave induced motion components were the only consideration since these represent comparatively low level accelerations (forces) acting upon the cargo. It is necessary, however, to introduce isolation from the high frequency slam or propeller induced accelerations. The simplest manner to accomplish this isolation is by means of resilient mounts which result in a cargo

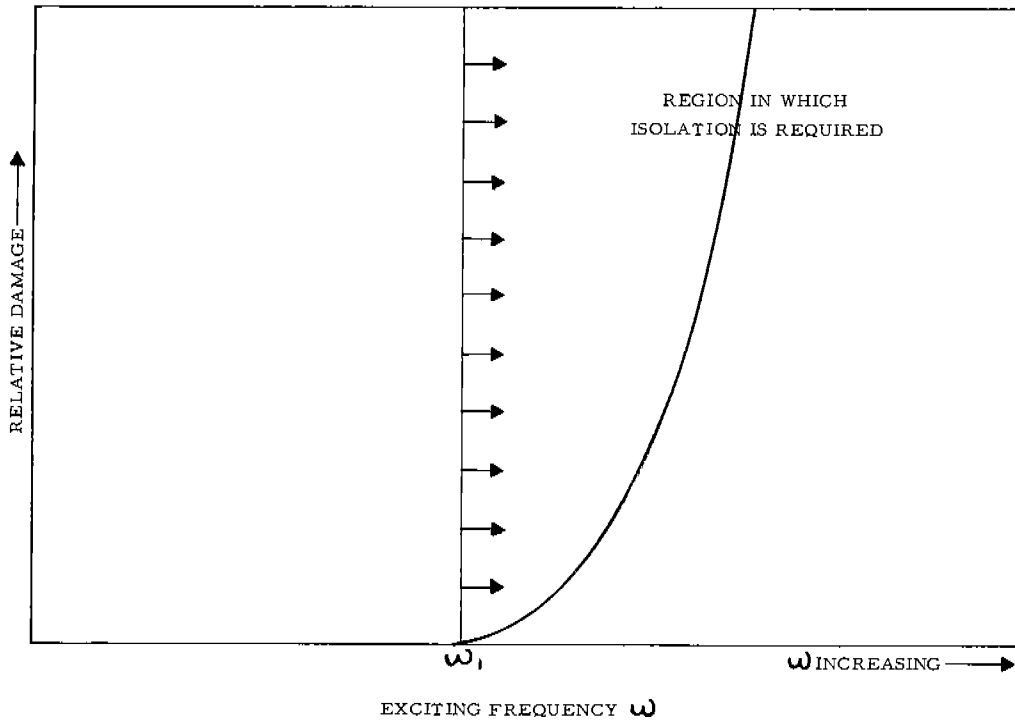

4(a)

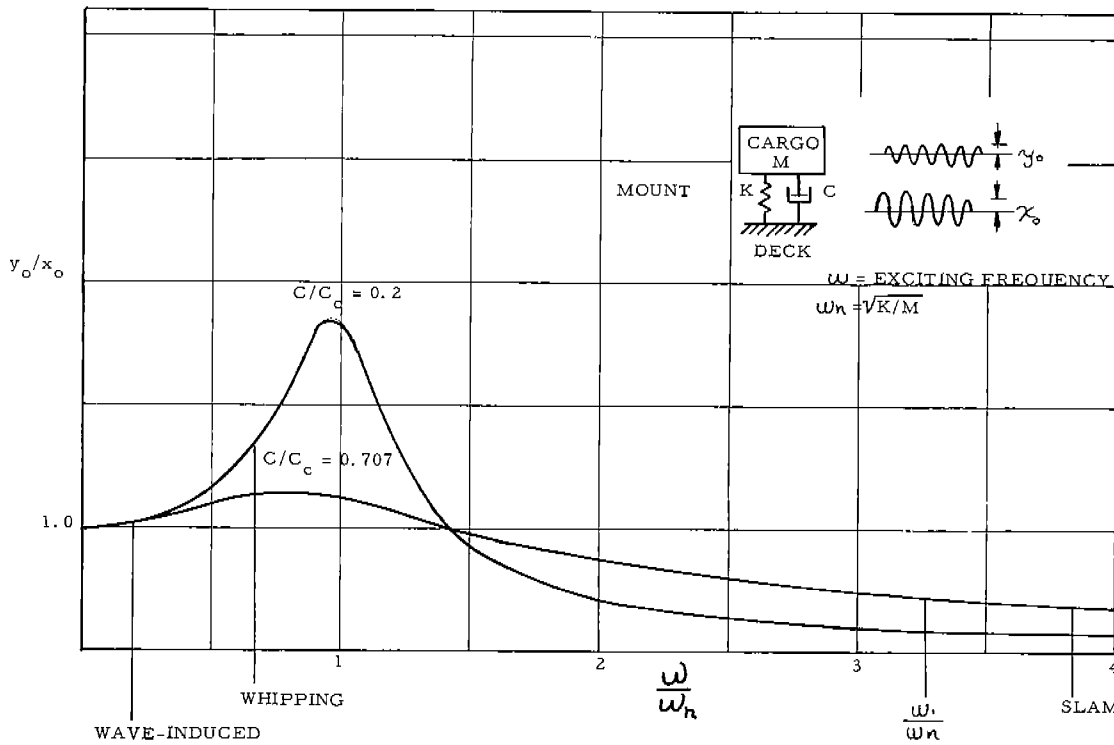

4(b)

FIG. 4. IDEALIZED SINGLE DEGREE OF FREEDOM SYSTEM AND ITS RESPONSE. (a) SCHEMATIC SHOWING SELECTION OF LIMITING FREQUENCY, ω_1 , FOR HIGH FREQUENCY CARGO DAMAGE. (b) SCHEMATIC OF CARGO DISPLACEMENT VERSUS EXCITING FREQUENCY.

mount system having a resonant frequency low compared to the frequency which must be isolated. Then one is faced with the problem of preventing excessive response at the resonant frequency of the cargo-mount system. To limit the response of this system, damping is added and the result is a reduction of response at the resonant frequency with an accompanying decrease in the effectiveness of isolation at high frequencies. These effects are illustrated by the curves which correspond to damping ratios of 0.2 and 0.707. Thus, if a proper compromise of cargo-mount natural frequency and system damping can be reached, a satisfactory isolation from damaging vibratory frequencies can be achieved without introducing new problems at the cargo-mount frequency.

In general, it is desired that the cargo be protected from the higher frequency components of the exciting displacements and accelerations since these are characteristic of shock loadings and are most likely to excite resonances in the equipment. In order to select the natural frequency of mounts such that the ratio of cargo displacement to deck displacement will approach zero, it is necessary that the frequencies transmitted by the deck be known. Note that the displacement frequencies correspond to those contained in accelerations recorded at the deck, and that for the same amplitude of acceleration, a high frequency implies a much lower displacement than does a low frequency component, since:

$$\ddot{X}_o = \omega^2 X_o$$

where

\ddot{X}_o = Amplitude of sinusoidal acceleration

X_o = Amplitude of sinusoidal displacement

ω = Frequency of excitation

Inspection of Figure 4 will indicate that if $\frac{\omega_1}{\omega_h}$ is such that $\frac{\omega_1}{\omega_h} = 4$, and the amplitude of motion at the cargo is satisfactorily limited, lower frequency excitation (say at the wave encounter frequency) will result in substantially larger excursions (equal to those of the deck) at the cargo. These are presumed not to be damaging.

In short, under these conditions (an isolated item of cargo connected to the deck through mounts) the high frequency components of displacement (acceleration) are of most interest; motion of the cargo at the lower frequencies is presumed to be acceptable. In passing, it should be noted that the natural frequency of the cargo-mount system must be chosen well away from the natural frequency of the deck-cargo system in order to avoid extreme amplitudes at the mounted cargo. This is probably not difficult to insure since the highest transmissible component in a slam is likely to be at about the deck natural frequency.

The second case is quite the reverse of the first in that the low frequency (long duration) displacements become of primary

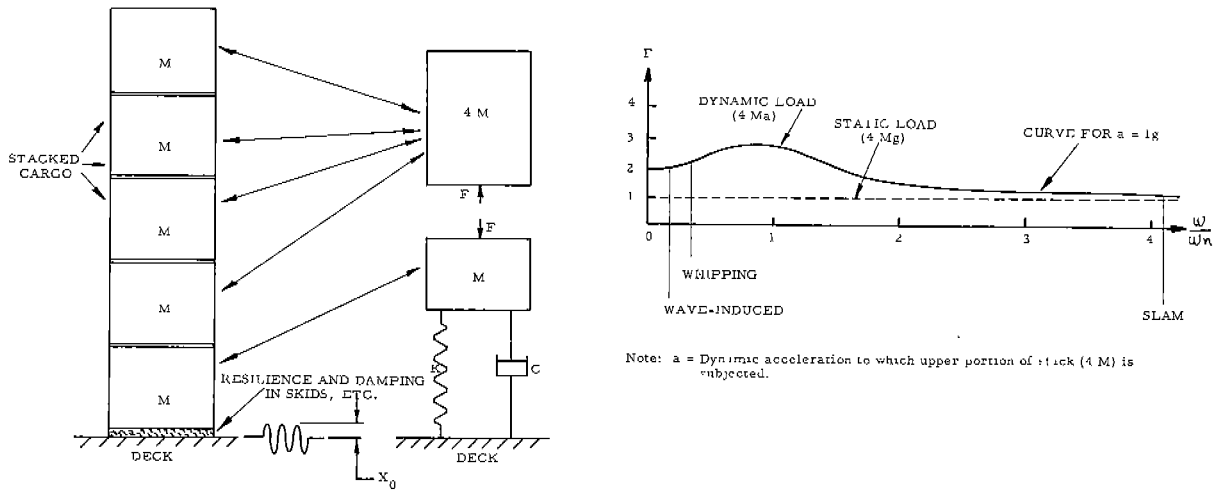

FIG. 5. SCHEMATIC OF LOADING ON BOTTOM UNIT OF A STACKED CARGO.

importance, but in a slightly different fashion. See Figure 5. The resilience and damping in the material in contact with the deck and in the first cargo unit effectively isolate the balance of the stacked cargo from higher frequency components of displacement such as those caused by slamming. The principal lower frequency components are transmitted without attenuation such that the full inertia load of the entire stack is borne by the first unit. Note that even though the units are stacked vertically in the sketch, the same general argument applies for horizontally adjacent units packed against a bulkhead. It is possible, therefore, that each unit must withstand a load many times its own weight.

VI. DESCRIPTION OF VESSEL AND DATA ACQUISITION SYSTEM

A. The S.S. WOLVERINE STATE

Some particulars of the S.S. WOLVERINE STATE are listed in Table I and a photograph of a sister ship is included as Figure 6. The vessel, a C4-S-B5 type, is operated by the States Marine Lines on regular North Atlantic service between the East Coast of the United States and English, French, Dutch, and German ports. See Figure 7. Mixed dry cargo, of relatively low density, is the usual lading. The outstanding feature of this class of vessel is the fact that machinery and accommodations are placed aft with a modest bridge structure forward of amidships.

B. The Data Acquisition System

1. General

The heart of the data acquisition system is an unmanned, programmed, slow-speed magnetic tape recorder which with auxiliary equipment was initially developed for the measurement of midship seaway induced bending moment stresses. The unit aboard the WOLVERINE STATE is an adaptation of the basic system aboard a sister ship, the S.S. HOOSIER STATE. The major difference between

TABLE I

PARTICULARS OF S. S. WOLVERINE STATE

A. General

Original Name: MARINE RUNNER
Type: C4-S-B5 Machinery-Aft Dry Cargo Vessel
Builder: Sun Shipbuilding and Drydock Company
Chester, Pennsylvania
Date: September 1945
Hull Number: 359
Length Overall: 520'-0"
Length Between Perpendiculars: 496'-0"
Beam, Molded: 71'-6"
Depth, Molded: 54'-0"
Depth, Molded to Poop Deck: 52'-0"
Depth, Molded to Upper Deck: 43'-6"
Depth, Molded to Second Deck: 35'-0"
Depth, Molded to Third Deck: 26'-0"
Load Draft, Molded (Design): 30'-0"
Load Draft, Keel (Full Scantling): 32'-9 7/8"
Gross Tonnage: 10,747
Net Tonnage: 6,657
Official Number: 248,740
Block Coefficient: 0.654 (30' Molded Design Draft)
0.61 (18' Typical Present Operation)
Prismatic Coefficient: 0.664 (30' Molded Design Draft)
0.628 (18' Typical Present Operation)
Waterplane Coefficient: 0.752 30'
0.685 18'
Midship Section Modulus
(with deck straps): 45,631 in.² ft. (to top of Upper Deck)

B. Light Ship

Light Ship Weight: 6,746 L. T.
Center of Gravity: 30.40 ft. above keel
24.20 ft. aft of amidships
Light Ship Drafts: 3'-7" forward
19'-9 1/2" aft
11'-8 1/4" mean

Dead Weight at 32'-9 7/8"
(Cargo Capacity): 15,348 L. T.

C. Machinery

Propulsion System: Steam Turbine with Double Reduction Gear

	<u>Normal</u>	<u>Maximum</u>
H. P. Turbine, Design R. P. M.	5,358	
L. P. Turbine, Design R. P. M.	4,422	
Propeller, Design R. P. M.	85	88
Propeller, Normal Operating R. P. M.	80	
Shaft Horsepower, H. P. Turbine	4,500	
Shaft Horsepower, L. P. Turbine	4,500	
Shaft Horsepower, Total	9,000	9,900
First Reduction Gear, H. P. Turbine	9.096	
First Reduction Gear, L. P. Turbine	7.508	
Second Reduction Gear	6.93	

the two systems is the provision for recording seven channels of acceleration data on the WOLVERINE STATE as well as the midship bending moment stress. Full particulars of both systems are given in reference (2); the detailed descriptive material to follow will be limited to the system aboard the WOLVERINE STATE.

In order to relate the recorded data to weather and sea and ship operating conditions, the ship's watch officers maintain a separate data log book. Samples are shown in Figure 8. The watch officers also replace data tapes on the recorder which may be required twice during a round trip voyage. Operation otherwise is completely automatic. The "Time Meter Reading" on the data log is obtained from an indicator associated with the magnetic tape recorder and serves to identify the interval in the log with the corresponding data interval on the magnetic tape.

A total of seven linear accelerometers were mounted on the centerline of the vessel - three at a location near the bow, measuring vertical, transverse and fore and aft accelerations; three similarly mounted near the stern, and a single transverse accelerometer amidships. The accelerometers were placed in cargo holds at locations on the ship where the highest accelerations might be anticipated, except that at the bow and stern the units were placed one deck below the weather deck in order to keep all of the instruments at the same level in the ship thus simplifying comparisons of transverse accelerations at the three locations.

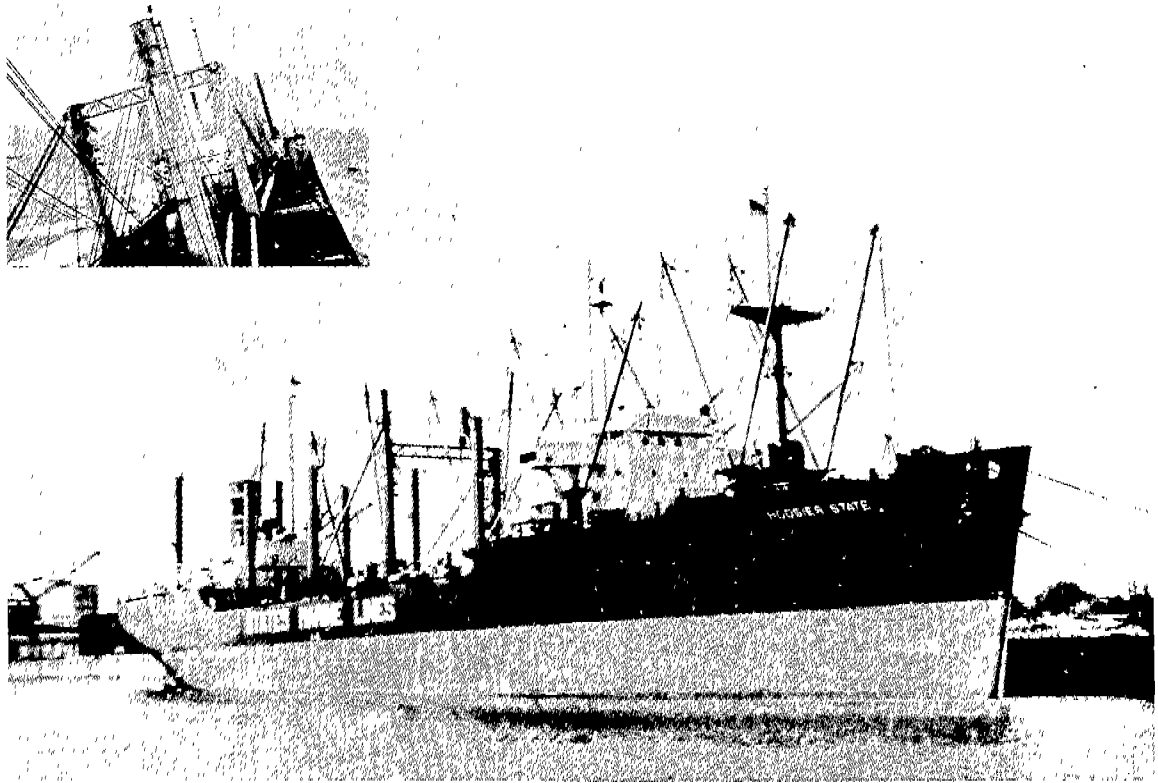

FIG. 6. PHOTOGRAPH OF S. S. HOOSIER STATE SISTER SHIP OF S. S. WOLVERINE STATE.

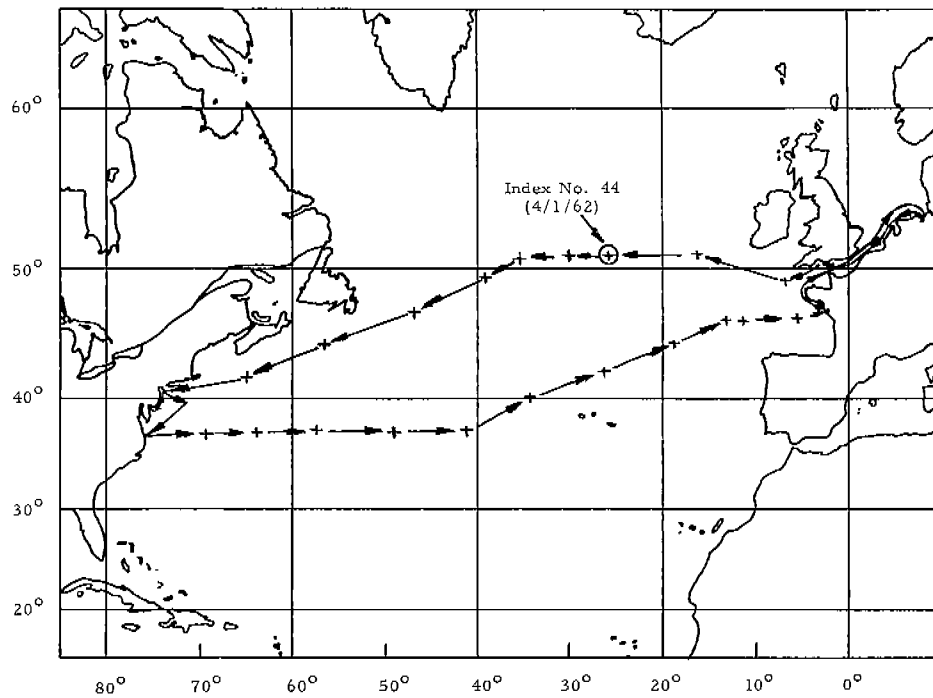

FIG. 7. TYPICAL ROUND-TRIP VOYAGE OF S. S. WOLVERINE STATE ON NORTH ATLANTIC TRADE ROUTE.

DATA LOG

SHIP Wolverine State

VOYAGE 174-175 FROM Southampton TO New York DATES 3-31-62 TO 4-2-62

Index No.	Date (M, D, Y)	Time Meter Rdg.	SHIP			WIND		Sea Temp.	Air Temp.	Knots True	True Wind Dir.	Weather	Initials
			Lat.	Long.	Course	Avg. Speed Knots (Past four hours)	Avg. Engine R.P.M.						
40	2020 3/31/62	1251.3	50°51'N	16°45'W	269°	14.5	81.6	52	44/41	18	WNW	cloudy occ. rain	R92
41	0040 4/1/62	1283.1			269°	14.5	80.6	50	43/41	14	WNW	cloudy occ. showers	982
42	0500 4/1/62	1316.0			269°	14.5	81.9	52	43/44	17	W	cloudy occ. showers	Pg
43	0900 4/1/62	1347.6			265°	15.0	81.5	50	49/46	20	W5W	overcast	R92
44	1300 4/1/62	1380.0	50°57'N	28°24'W	265°	14.0	81.2	49	54/50	25	WNW	mostly cloudy	982
45	1700 4/1/62	1413.4			284°	12.0	73.6	50	50/48	30	SW	overcast	Pg
46	2120 4/1/62	146.8			265°	8.0	65.8	48	50/50	30	W	overcast cont. rain	R92
47	0140 4/2/62	1821.0			265°	5.0	51.8	47	46/45	26	W	overcast cont. rain	982
48	0600 4/2/62	2172.6			265°	4.0	49.2	48	46/44	30	WNW	mostly cloudy occ. rain	Pg
49	1000 4/2/62	2209.9			265°	2.0	49.1	49	45/41	45	W	partly cloudy	982
50	1400 4/2/62	2285.3											

SEA

Index No.	Beaufort Sea State Number	Wave True Direction	Avg. Wave Height Ft.	Avg. Wave Period Sec.	Avg. Wave Length Ft.	Swell			Barometer Reading & Sea Photo Number	Remarks (Changes of Course, Changes of Speed, Changes of Ballasting, Slamming, Rewind Recorder)
						Avg. Height Ft.	Avg. Length Ft.	True Direc.		
40	5	290°	5-7	8-10	70'		1000	340°		Rolling + Pitching moderately
41	4	295°	4-6	7-9	60'		1000	355°		Rolling + Pitching easily
42	5	270°	3-6	6-9	60'		800	290°		Rolling + Pitching easily
43	5	250°	4-7	7-10	70'		600	270°		Rolling + Pitching easily 0625 of 1/265° Rolling + Pitching easily to moderately
44	6	250°	5-7	8-10	75'		500	270°		Pitching Moderately
45	7	230°	6-10	8-12	80'		450	cont		1300 c/c to 208 T 1330 - Reduced speed to 70 R.P.M.'s Rolling + Pitching mod. to heavy
46	7	270°	8-12	10-14	100'		900	250°		1855 Increased speed to 60 R.P.M. 1910-5 25° Roll Pitching + yawing heavily
47	6-7	270°	7-10	8-12	75'		900	250°		2020 Reduced speed to 55 R.P.M. 2315 Reduced speed to 50 R.P.M. Toward Rolling + Pitching heavily
48	7	290°	8-10	8-12	75'		800	250°		Toward Rolling + Pitching heavily
49	9	270	16-20	18-20	180'		1200	270°		Proceeding as Reduced speed to ease severe Rolling, Pitching + yawing heavily
50										

FIG. 8. SAMPLE OF DATA LOGBOOK ENTRIES, S. S. WOLVERINE STATE.

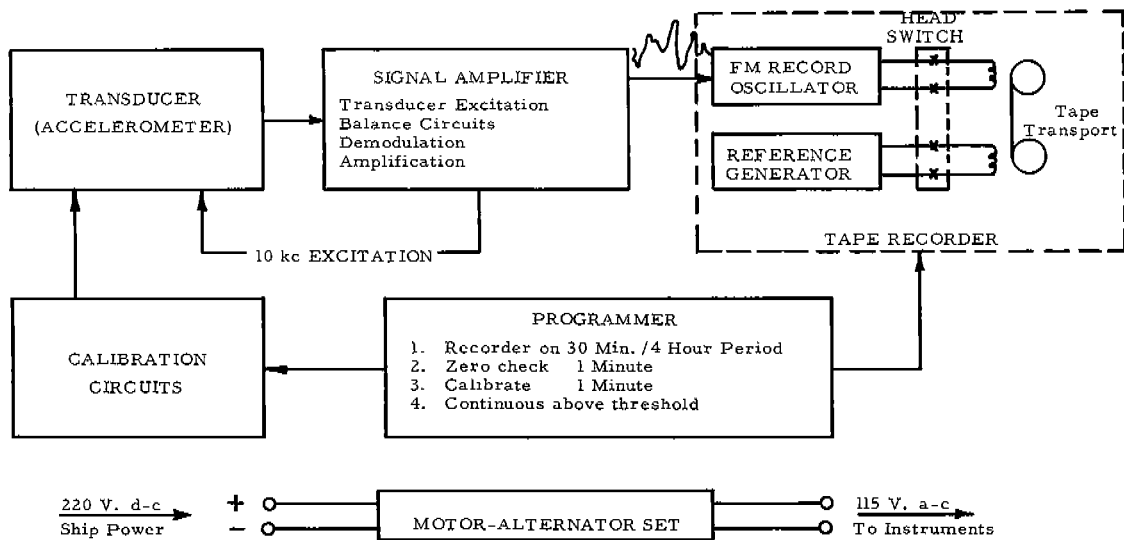

FIG. 9. FUNCTIONAL BLOCK DIAGRAM, ACCELERATION CHANNELS.

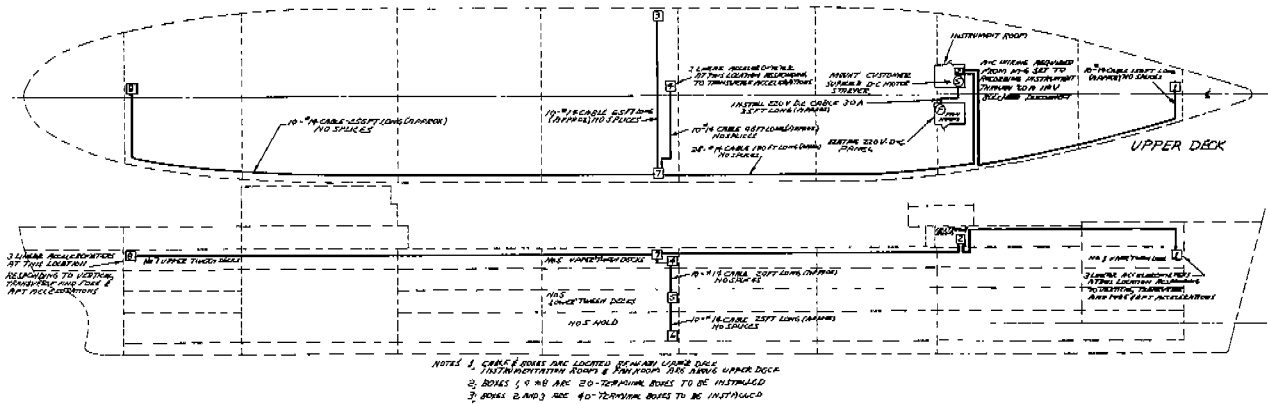

FIG. 10. INSTRUMENTATION CABLE AND TERMINAL BOX LAYOUT S.S. WOLVERINE STATE.

The choice of linear accelerometers and selection of their positions aboard ship was based on the simple presumption that the recorded data must reflect only the maximum accelerations to which cargo would be subjected, or at least permit deduction of the maxima. If the motions of the vessel were under investigation, a combination of angular and linear accelerometers would yield the most readily digestible data.

It was recognized at the outset that the fore-and-aft accelerations would be quite small compared to those in the other two perpendicular directions. It was also felt that one or two of the transverse accelerometers might be redundant. It was thought, however, that a prudent approach would dictate the use of seven accelerometers initially until it had been established that vector quantities would not be required and until some data had been obtained and the final methods of interpretation established.

A functional block diagram of a single typical acceleration channel is shown in Figure 9. Figure 10 indicates the transducer

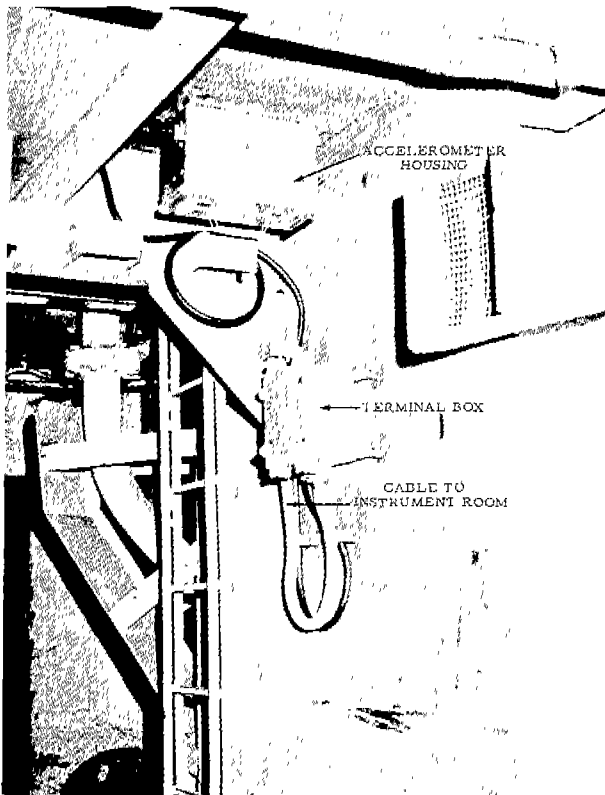

FIG. 11. PHOTOGRAPH OF COMPLETED ACCELEROMETER HOUSING INSTALLATION.

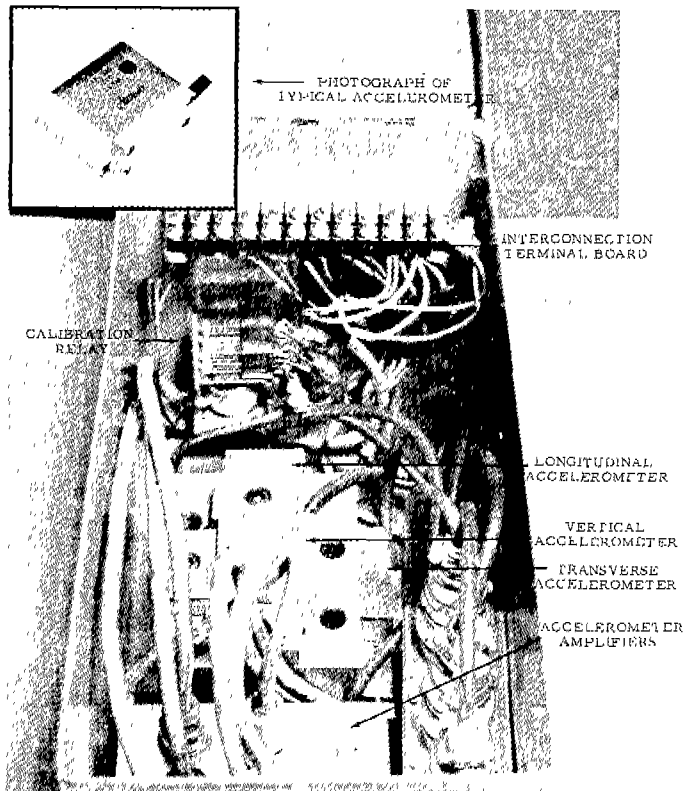

FIG. 12. PHOTOGRAPH OF INTERIOR OF ACCELEROMETER HOUSING.

cabling installed aboard the S. S. WOLVERINE STATE and shows the location of the accelerometers at bow, stern, and amidships.

The following sections describe the various components of the data collection system. Detailed specifications of the individual components are included as Appendix A.

2. Accelerometers

Unbonded strain gage linear accelerometers (Statham Instruments, Inc. Model A3) having a range of ± 2.5 g and a natural frequency of 55 cycles per second have been used in all accelerometer locations. Strain gage accelerometers were selected because of the very low frequencies encountered in wave induced accelerations. The useful frequency range of these accelerometers is from 0 (d-c) to 33 cycles per second. The accelerometers are calibrated electrically in the same manner as an electrical resistance strain gage bridge, that is, by shunting one arm of the strain gage bridge with a calibration resistor of the proper value. Figure 11 illustrates the completed installation of a moisture proof box containing strain gage accelerometers, their associated signal amplifiers, and remotely operated calibrating circuits. The boxes are bolted to steel plates which have previously been welded to the overhead.

Figure 12 provides an interior view of the accelerometer housing. In the center is seen a machined steel block with three mutually perpendicular sides to which are attached the three linear

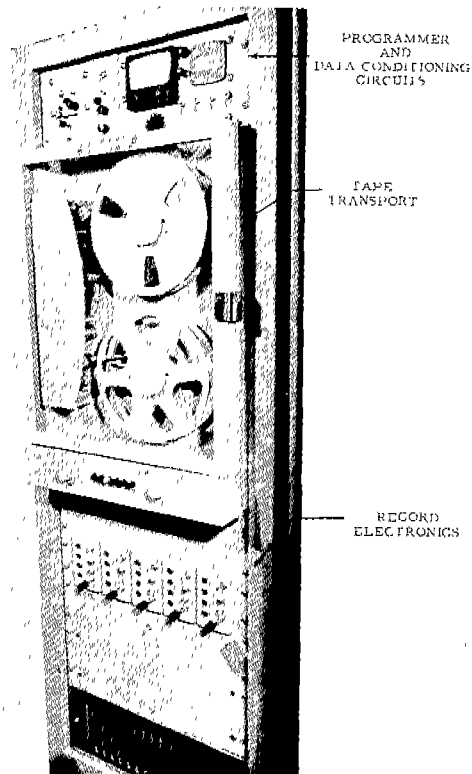

FIG. 13. PHOTOGRAPH OF INSTRUMENTATION SYSTEM ABOARD S. S. WOLVERINE STATE.

accelerometers. Through-bolts attach this block firmly to the steel plate previously mentioned so that the accelerometers are in intimate contact with the ship's structure. The accelerometer signal amplifiers are located in front of the accelerometer mounting block and the remote calibration relay is seen at the rear of the box.

3. Accelerometer Amplifiers

Transistorized accelerometer signal amplifiers (Statham Instruments, Inc. Model CA9-56) are employed to supply excitation to the strain gage accelerometers and amplify the transducer output to a level which matches the input requirements of the tape recorder.

The accelerometers are used in a carrier system. Ten kilocycle per second carrier excitation is supplied by the amplifier unit to the strain gage bridge in the accelerometer. The accelerometer bridge output is then demodulated in the amplifier unit and amplified to the proper level. Since the amplifier units are located adjacent to the accelerometers, only the d-c power required to operate the amplifier and the low frequency signals from the accelerometers are carried by the shipboard instrumentation cables.

4. Recording System

The shipboard magnetic tape data recording system is illustrated in the system block diagrams, Figure 9 and the photograph, Figure 13. The cabinet is 27 x 27 x 70 inches. The system is based on the Model 3168 tape transport manufactured by Minneapolis-Honeywell Regulator Company of Denver, Colorado. The system uses 10 1/2 inch reels of one-inch wide magnetic tape having a 1-mil (0.001")

mylar backing. A 14-track IRIG standard magnetic recording head permits the recording of up to 14 channels on the one inch wide tape and provides compatibility for playback of the tapes on other standard machines. A tape speed of 0.3 inches per second permits the recording of forty hours of data on a single pass of the tape. The frequency modulation recording technique is used to provide a system frequency response 0 (d-c) to 50 cycles per second. (The IRIG standard center frequency at 0.3 inches per second is 270 cycles per second.)

Because of the very slow tape speed, the system incorporates electronic compensation for the noise resulting from irregularities of tape motion. A constant frequency is recorded on one of the tracks of the tape. During playback, variations in the frequency which is recorded on this track resulting from motion irregularities (flutter and wow), produce signals which are subtracted from the outputs of the data channels to improve the overall system signal-to-noise ratio.

The recording system on board the WOLVERINE STATE utilizes 10 of the 14 available tracks (one stress channel, seven acceleration channels, one compensation channel, and one spare channel). At the end of each forty hours of record the ships Second Officer rewinds the tape and replaces it with a new reel.

5. Programming Unit

A programming unit developed by the Investigators has been incorporated to provide the automatic operation of the shipboard recording system. The functions of this unit are indicated in the system block diagram, Figure 9. A schematic diagram of the programming unit aboard the S.S. WOLVERINE STATE is included as Figure 14. The front panel of the programming unit appears at the top of the complete recording system cabinet, see photograph, Figure 13. This panel includes the Strain Gage Module, the Strain Gage Amplifier, the Stress Meter, and an elapsed time meter which serves as a tape footage counter.

The fundamental purpose of the programming unit is to turn the recording system on regularly at four-hour intervals to obtain a data record of thirty minutes duration. At the beginning of each of these records, the unit performs a calibration sequence. The power is removed from all transducers for a one minute system zero-check. Then, during a second minute, calibration resistors are alternately shunted and removed from across one arm of the strain gage bridge in each transducer. The calibration sequence provides checks on system zero drift and calibration changes, and also provides timing markers along the tape record since the sequence is repeated at regular four-hour intervals. A sketch of a typical interval of data record is shown in Figure 15. As noted in this figure data signals are superimposed upon the calibration signals. The change of level occurring at the beginning and end of the calibration pulses serve to indicate the calibration level. The acceleration channels are calibrated for an acceleration change of 0.5 g.

In addition to obtaining regular records of fixed length and providing calibration signals, the programming unit will also obtain extended records of data when the sea conditions are extremely bad.

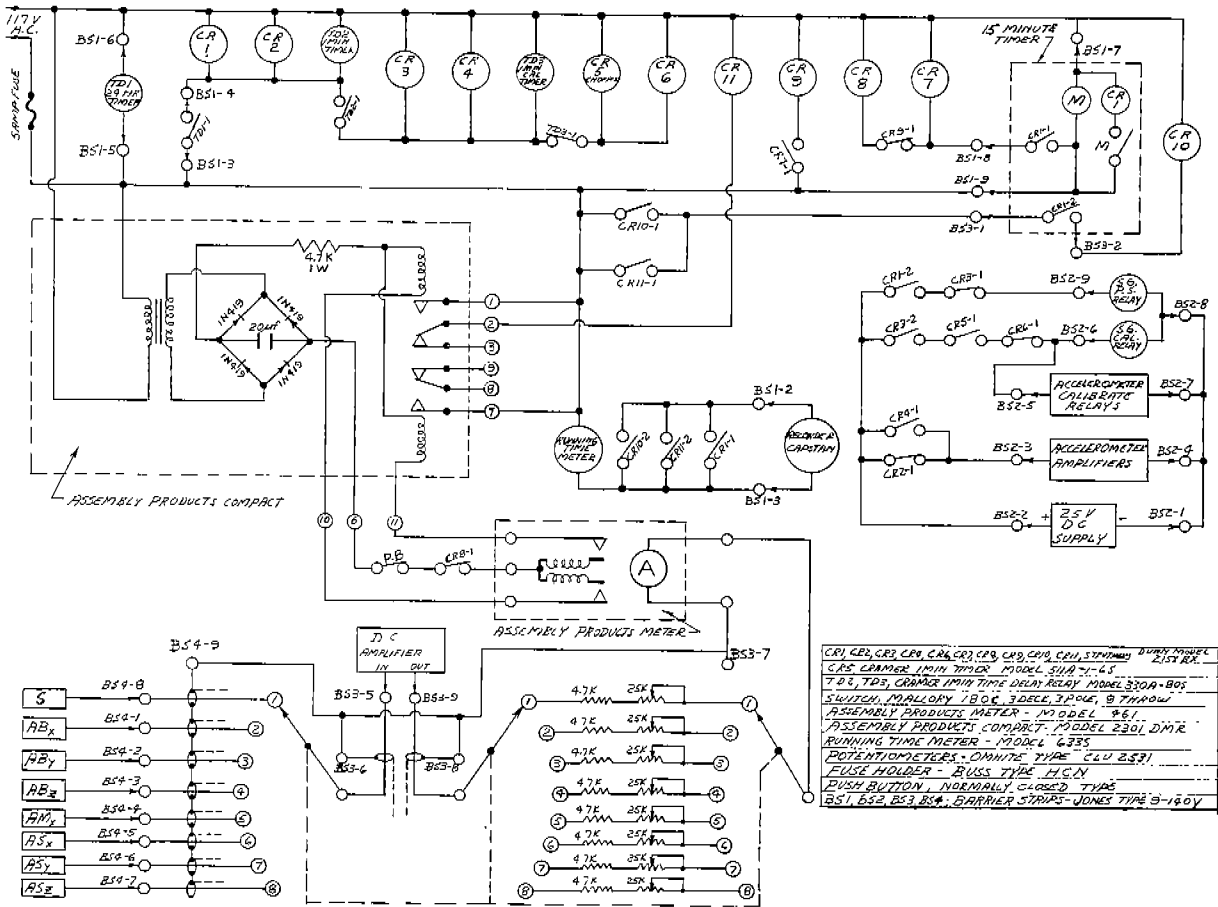

FIG. 14. PROGRAMMER WIRING SCHEMATIC S. S. WOLVERINE STATE.

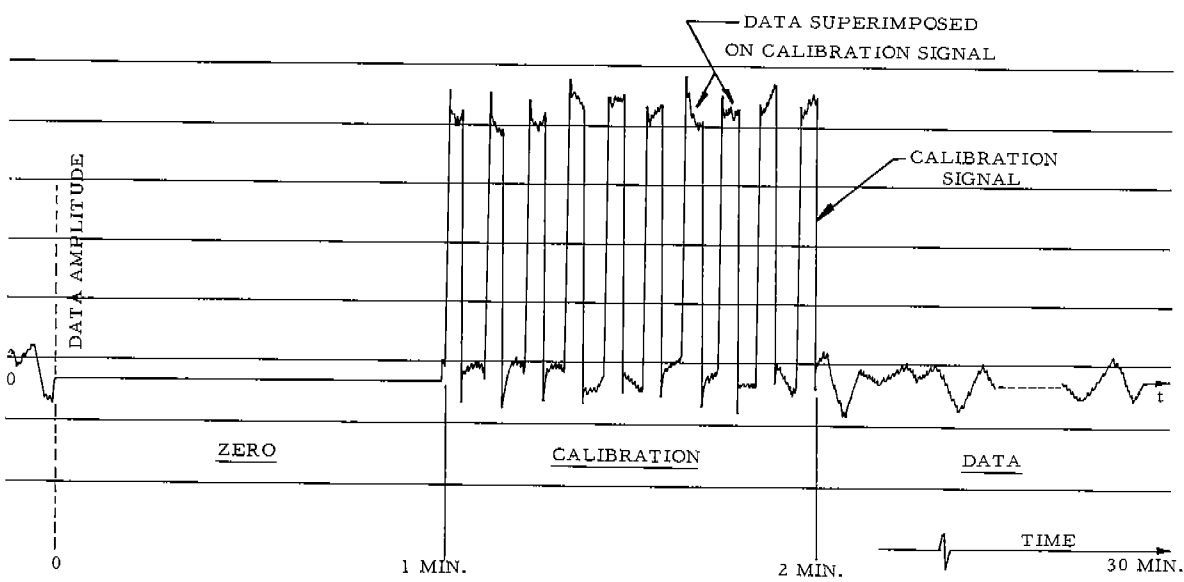

FIG. 15. TYPICAL INTERVAL OF DATA RECORD.

Adjustable contacts on the Stress Meter can be set to selected threshold values at which the programming unit can be triggered to turn on the recorder and obtain records in fifteen minute increments in addition to the regular records of one-half hour duration. A stress level above the preset threshold will turn the recorder on. An automatic timer will turn the recorder off at the end of fifteen minutes unless stresses continue above the preset level.

6. Auxiliaries

a. Shipboard cables

Prior to the actual installation of the recording system aboard ship, cabling from the instrumentation room to the transducer locations, and from the instrumentation room to the source of shipboard 220-volt d-c power was added to the ship. Since it was required that this wiring meet Coast Guard approval, it was necessary that the wiring be installed by marine contractors under the supervision of the Investigators. Figure 10 illustrates the instrumentation cabling which was added to the ship. The power to operate the recording system, about 1500 watts, was drawn from the lines to the forward quarters ventilation system.

b. Motor-alternator set

A conversion device was needed to convert the 220-volt d-c shipboard power to 110-volt 60-cycle a-c power to operate the recording system. A surplus 7.5 KVA shipboard motor-alternator set with the required starting and protective circuits was purchased and installed aboard the ship.

c. Remote indicating instruments for ship Chart Room

As part of the data log maintained for this project, the officer on watch records the reading from an elapsed time meter. This provides the total time that the recorder has recorded data during the previous four hours, and serves to tie the tape record to the data log. To observe this meter, the watch officer must leave the bridge and go two decks below to the recording equipment. Because of this inconvenience, it was requested that a remote indicating meter be located in the Chart Room.

The investigators agreed that a remote indicating running time meter would be installed in the Chart Room. It was also decided, since the additional cost was slight, to include a remote indicating stress meter. The resulting installation is pictured in Figure 16.

The ship personnel were instructed to take their time meter readings from this remote running time meter in the Chart Room, and to reset it to zero when tape is rewound to agree with the meter on the recording equipment.

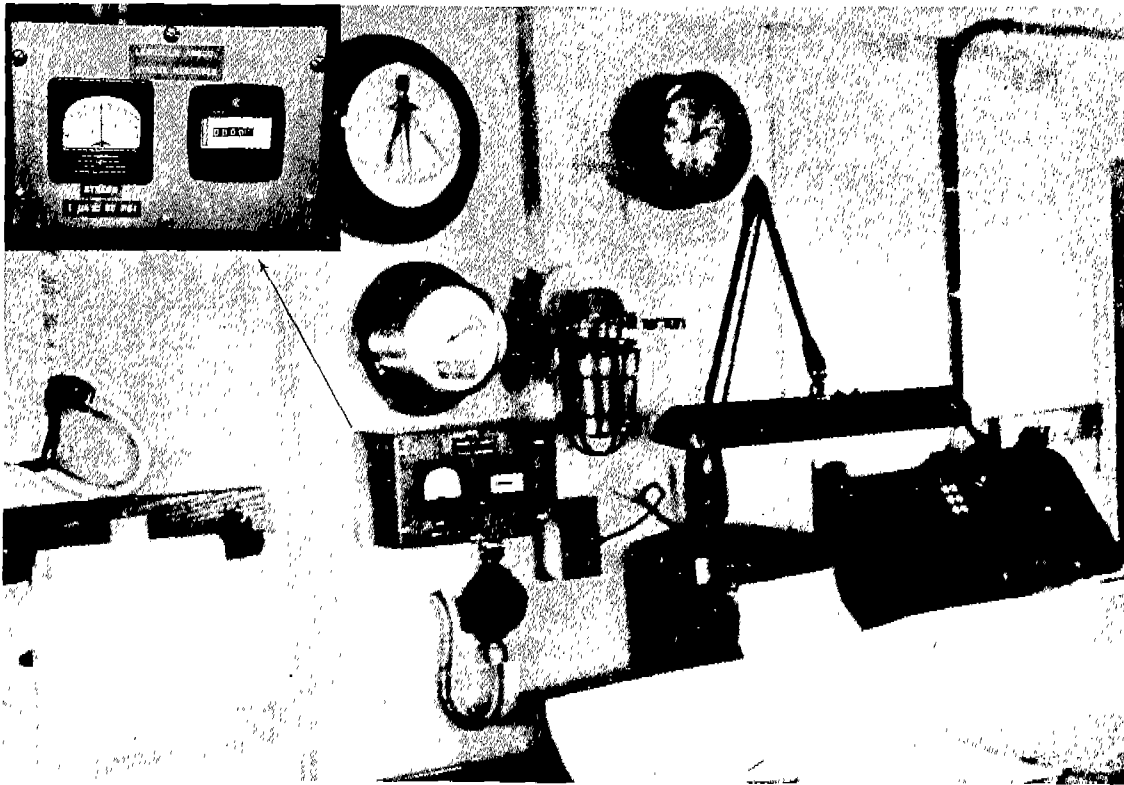

FIG. 16. PHOTOGRAPH SHOWING REMOTE INDICATOR INSTALLED IN CHART ROOM OF SHIP.

7. Equipment Maintenance and Performance

The installation aboard the S. S. WOLVERINE STATE was completed in December 1961. Up to April 1963, the equipment had operated satisfactorily for 14 out of 15 round trip voyages.

A regular maintenance check is made aboard the ship, approximately once a month, at the completion of each round-trip voyage. During these visits, the operation of the recording system and the condition of all transducers is checked; any needed repairs are made, and routine preventive maintenance is performed.

8. Statistical Accelerometers

Shortly after the basic instrumentation described above was installed and operational, the question was raised as to whether or not the linear accelerometers being placed high in the ship would reflect the maximum accelerations resulting from slamming. The hull damage caused by slams is observed to occur on the bottom at the fore-foot of the vessel between one-quarter and one-third of the length back from the bow. This suggested that local accelerations in cargo spaces in this area might exceed those higher in the ship.

In order to establish the relative magnitudes of vertical acceleration in various locations in the ship, a number of statistical accelerometers were dispersed in cargo spaces as noted on Figure

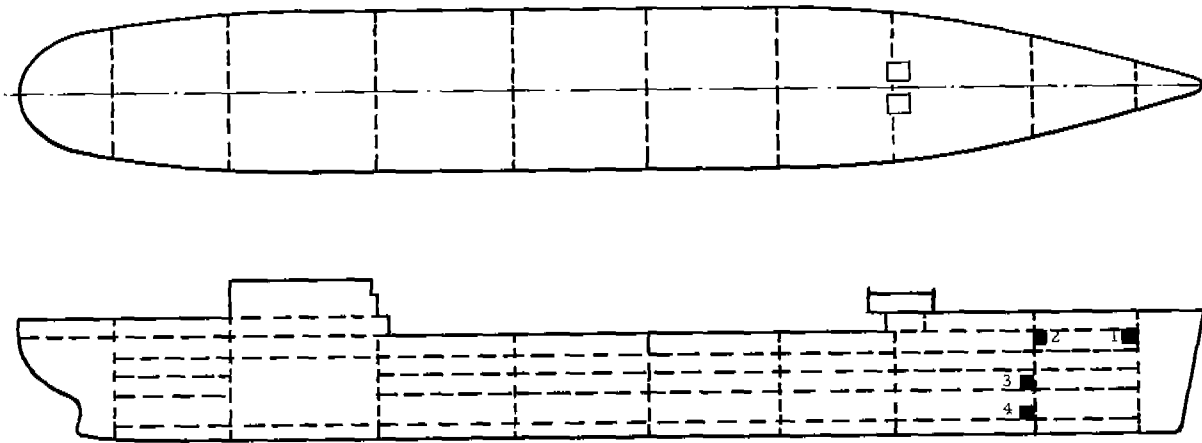

Statistical Accelerometer Number	Location
1	#1 Upper 'Tween Decks Forward
2	#1 Upper 'Tween Decks Aft
3	#2 Lower 'Tween Decks Forward
4	#2 Hold Forward

FIG. 17. LOCATIONS OF STATISTICAL ACCELEROMETERS ABOARD S. S. WOLVERINE STATE.

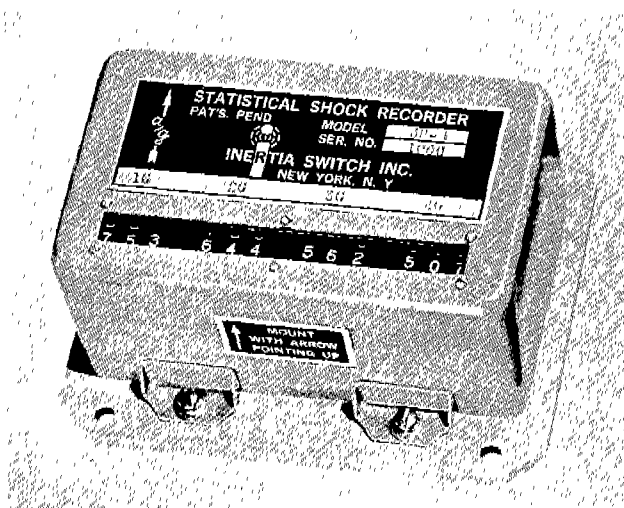

FIG. 18. PHOTOGRAPH OF STATISTICAL ACCELEROMETER.

17. These devices were Inertia Switch Model SR-4 Statistical Accelerometers, recalibrated such that the counters indicate the number of times the linear acceleration in the sensitive direction exceeds 0.1, 0.25, 0.5 and 1.0G. Figure 18 is a photograph of the SR-4 statistical accelerometer. Other details on these units are listed in Appendix A.

VII. DESCRIPTION OF DATA REDUCTION SYSTEM AND METHODS OF ANALYSIS

A. The Data Reduction System

1. General

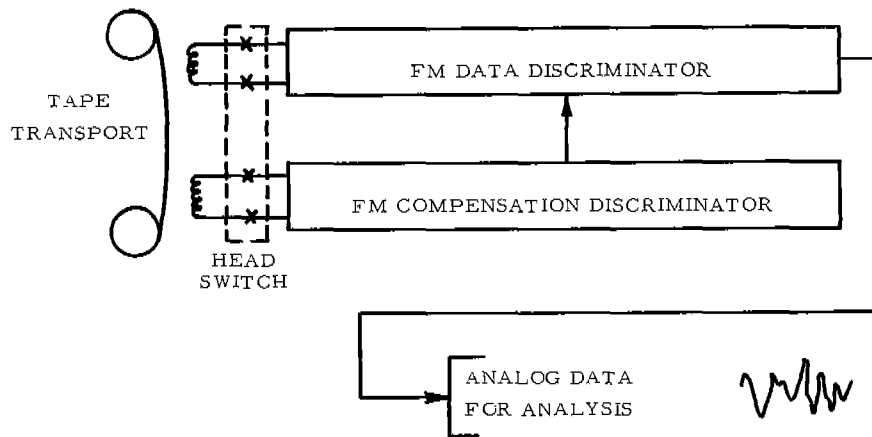

FIG. 19. FUNCTIONAL BLOCK DIAGRAM, DATA REPRODUCE SYSTEM.

All data reduction and analysis functions are performed in the Investigators' laboratory. The basic system components consist of a magnetic tape playback unit, a special purpose probability analyzer, and a direct reading oscillograph which accepts either the analogue output of the playback (thus reproducing the original recorded information), or the output of the probability analyzer. The principal features of these units and their use in developing the information to be presented and discussed in later sections will be described below and in Appendix B.

2. Magnetic Tape Playback System

The tape playback system is compatible with the shipboard recording units in that it accommodates 10 1/2 inch reels of one-inch wide magnetic tape which have been recorded using frequency modulation techniques on the standard 14 track IRIG configuration. The purpose of the system is to reconstruct the original data in the form of analogous electrical signals which can be used as inputs to graphical recorders or automatic data-analysis systems. Figure 19 is a functional block diagram of a typical reproduce channel. Additional data on the playback system are given in Appendix B.

3. The Probability Analyzer

The probability analyzer, manufactured by Sierra Research Corporation of Buffalo New York, will accept the output of the tape reproduction system and filter it to remove slamming signals. The seaway induced signal is then subjected to analysis by the use of digital peak-detectors whereby counts at given signal levels are stored in a series of sixteen counters. Peak-to-peak, positive or negative amplitudes can be detected. Storage continues until the analysis interval has been completed on the basis of a selected time duration or until a pre-set number of peak-to-peak counts has been acquired. At this time, the system automatically stops the analysis and provides for a readout cycle directly on a strip chart recorder.

The information readout on the strip chart recorder (as sequential signal levels with appropriate calibrate and zero signals) includes the outputs of the 16 level occurrence counters (thus giving a complete histogram of number of occurrences versus signal level), the total number of counts, the mean value of the peak-to-peak

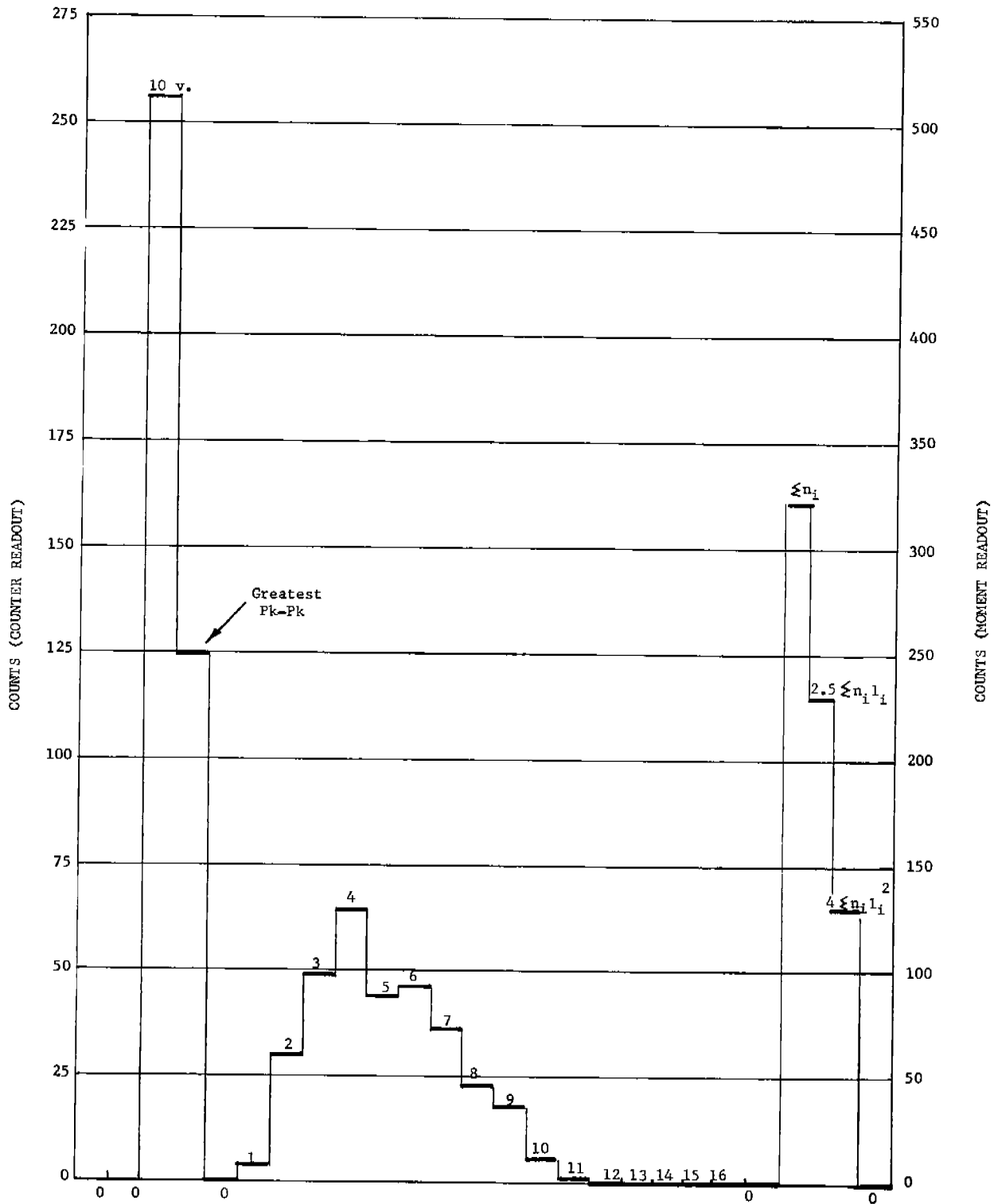

FIG. 20. TYPICAL RECORD OF PROBABILITY ANALYZER OUTPUT.

signal level, the mean-square value, the time duration of the analysis cycle, and the maximum peak-to-peak amplitude encountered during the interval under investigation. See Figure 20. The unit then indexes

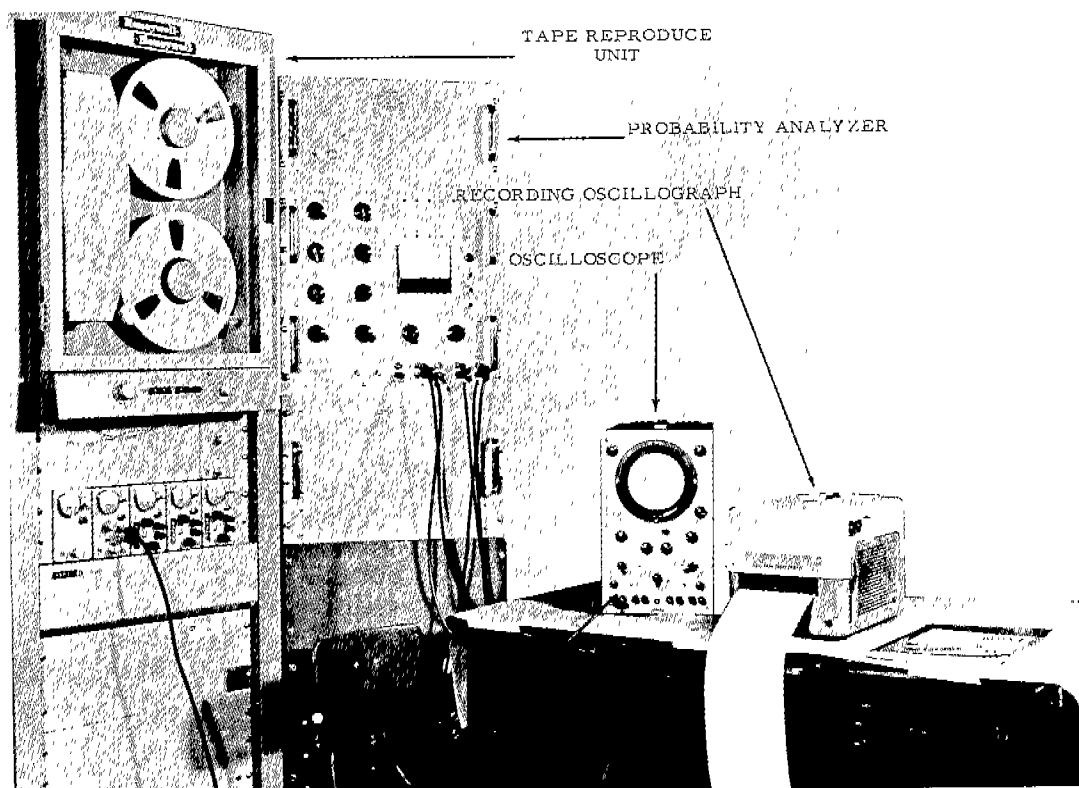

FIG. 21. PHOTOGRAPH OF DATA ANALYSIS SYSTEM.

the playback system automatically to the beginning of the next succeeding record, proceeds through the analysis portion of the cycle, and moves directly to the readout cycle. The statistical data are therefore available on the chart record in a form which permits a check of the fit of the recorded data with the theoretical distributions, and all other parameters required for future extreme value predictions are immediately available.

One of the biggest advantages of the Sierra unit is that the data can be played back at approximately 200 times real time. Thus, for each 160 hour tape, something less than one hour of actual data analysis time is required on the instrument for each channel plus about four hours for subsequent manual operation. This is, of course, a substantial savings (by more than an order of magnitude) over the time required for manual analysis.

The entire data analysis setup is shown in the photograph of Figure 21 and details of the Sierra Unit are given in Appendix B.

B. Methods of Analysis

1. General

Discussion in these sections will be confined to the means whereby the parameters classifying both the accelerations and the sea state and/or weather are extracted from the data tapes and log for each recording interval. Two classes of analysis are required: one for the basic wave-induced accelerations, and the other for slam-

ming, pounding or whipping.

It should be emphasized again that all discussions to follow are based on peak-to-peak acceleration variations as defined in Section V and illustrated in Figure 2.

2. Wave-Induced Accelerations

Figure 22 illustrates the steps in reduction of wave-induced acceleration data. First, a "quick look" record is made of several channels of each data tape (usually stress and acceleration). This results in a greatly compressed record with the recording intervals being separated by the calibration signals. The "quick look" permits a gross assessment of the quality of the data and immediately indicates intervals of unusual interest (very rough or very calm seas).

Each channel, in sequence, is then played into the probability analyzer at a tape speed of 60 inches per second (200 times recording speed). The filtering at the input of the analyzer is such as to pass the range 1 to 66 cycles per second (or .3 cycles per minute to 19.8 cycles per minute at the recording speed), thus cutting out all higher frequency components including slamming. As will be seen later, the basic wave-induced accelerations have a frequency in the range 5 to 10 cycles per minute. The analysis is conducted in the "Time" mode with a one second delay to permit the analyzer to establish a signal zero reference followed by a six second analysis period. Since the cycle is automatically triggered by the calibration signals at the beginning of each interval, this is equivalent to establishing zero reference for about three minutes, and analyzing data for an additional twenty minutes out of the total thirty minute data recording interval. As the analysis cycle is completed, the tape playback is automatically shut off, the reduced information is automatically printed out on the Visicorder and the cycle automatically re-initiated.

The records containing the probability analyzer output are then read and the lengths (in number of machine counts) of the appropriate outputs (in this case, those proportioned to maximum peak-to-peak value, mean square value, and total number of counts) recorded in the space provided on the record. These are then transferred to the final data sheet and by means of the appropriate calibrations, converted into proper units. At this point, the analyzer record and quick look intervals are justified, and the sea and weather data transferred to the data sheets.

3. Slamming Accelerations

Detailed analysis of slamming accelerations was performed only on the output of the bow vertical accelerometer. This was essentially a manual analysis performed as follows.

After appropriate calibration levels had been established for each tape, the accelerometer signal was played into the direct reading oscillograph through a filter network which passed only those signals in the range of 1.3 to 35.0 cycles per second (real or ship time). Chart paper speed was chosen so as to compress the record considerably. The resultant record, shown in Figure 23, contained the slams (when present) as well as background white noise which was present on all accelerometers. A mask, equivalent to 0.35 g peak-to-peak



1. "QUICK-LOOK"

STRESS
ACCELERATIONS



2. PROBABILITY ANALYZER
OUTPUT

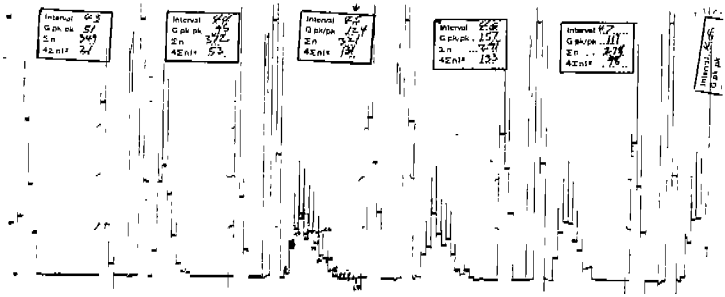

3. TRANSCRIPTION FROM
ANALYZER OUTPUT

MACHINE DATA REDUCTION
ACCELERATION DATA

DATE 8-25-68
PROJ. NO 2211415
CODE NO 1743023
FUNCTION A 02

$X_m = 133 \frac{h}{256}$ WHERE $Q = 1.5$ AND $133 \frac{Q}{256} = .0077$ DFL

$E = \frac{Q^2 K}{4ENL}$ WHERE $Q^2 = 2.25$ AND $Q^2 = 5625$

RECORD INTERVAL	INDEX NUMBER	BEAUCOET SEA STATE	(N) GREATEST DE-PC (COUNTS)	ZEN (COUNTS)	(L) 4ENL (COUNTS)	CALL. X_m (g-p-p)	CALL. E (g)	WIND VEL KNOTS	WAVE HT FT
43			51	349	21				
44			95	372	53				
45			124	321	131				
46			157	291	133				
47			117	278	98				

4. CALCULATION

MACHINE DATA REDUCTION
ACCELERATION DATA

DATE 8-25-68
PROJ. NO 2211415
CODE NO 1743023
FUNCTION A 02

$X_m = 133 \frac{h}{256}$ WHERE $Q = 1.5$ AND $133 \frac{Q}{256} = .0077$ DFL

$E = \frac{Q^2 K}{4ENL}$ WHERE $Q^2 = 2.25$ AND $Q^2 = 5625$

RECORD INTERVAL	INDEX NUMBER	BEAUCOET SEA STATE	(N) GREATEST DE-PC (COUNTS)	ZEN (COUNTS)	(L) 4ENL (COUNTS)	CALL. X_m (g-p-p)	CALL. E (g)	WIND VEL KNOTS	WAVE HT FT
43			51	349	21	.392	.077		
44			95	372	53	.731	.080		
45			124	321	131	.954	.229		
46			157	291	133	1.208	.257		
47			117	278	98	.900	.198		

5. SEA AND WIND
INFORMATION
FROM DATA LOG

MACHINE DATA REDUCTION
ACCELERATION DATA

DATE 8-25-68
PROJ. NO 2211415
CODE NO 1743023
FUNCTION A 02

$X_m = 133 \frac{h}{256}$ WHERE $Q = 1.5$ AND $133 \frac{Q}{256} = .0077$ DFL

$E = \frac{Q^2 K}{4ENL}$ WHERE $Q^2 = 2.25$ AND $Q^2 = 5625$

RECORD INTERVAL	INDEX NUMBER	BEAUCOET SEA STATE	(N) GREATEST DE-PC (COUNTS)	ZEN (COUNTS)	(L) 4ENL (COUNTS)	CALL. X_m (g-p-p)	CALL. E (g)	WIND VEL KNOTS	WAVE HT FT
43	43-44	6	51	349	21	.392	.073	25	5-7
44	44-45	7	95	372	53	.731	.080	30	6-10
45	45-46	7	124	321	131	.954	.229	30	8-12
46	46-47	6-7	157	291	133	1.208	.257	26	7-10
47	47-48	7	117	278	98	.900	.198	30	8-10

FIG. 22. SCHEMATIC OF ANALYSIS OF WAVE-INDUCED ACCELERATIONS.

ACCELERATION
OSCILLOGRAM

UNFILTERED

FILTERED

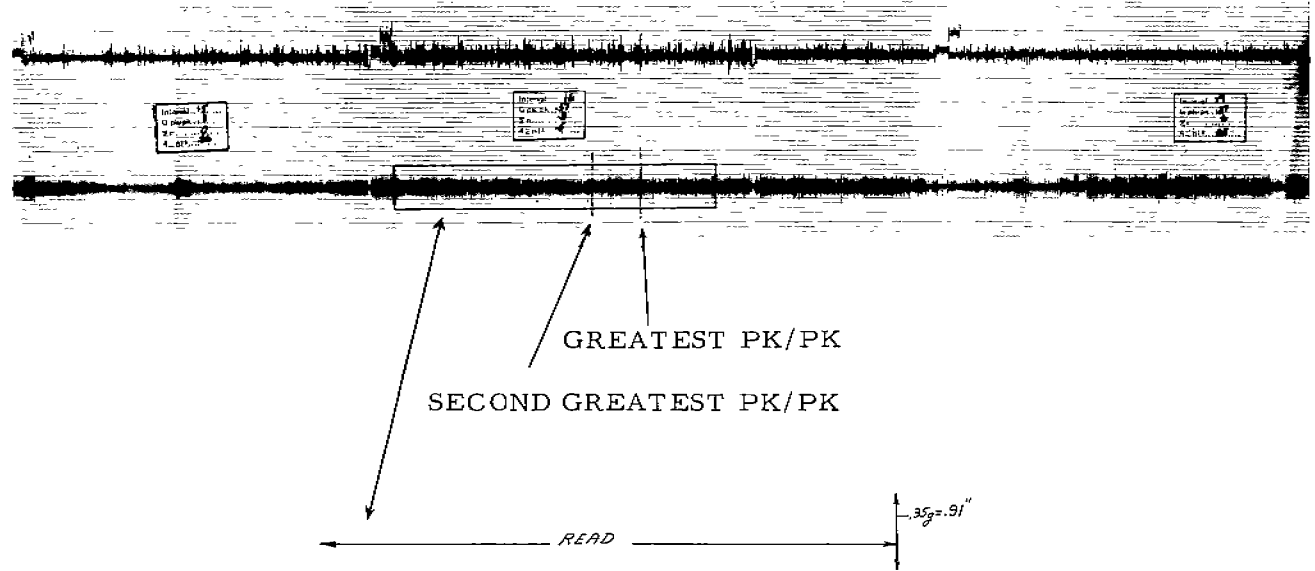

MASK

LOG SHEET

MACHINE DATA REDUCTION
ACCELERATION DATA

DATE: 5-8-63
PROJ. NO. 787116
CODE NO. 130W135
FUNCTION: SLAM

$X_m = 1.33 Q \frac{h}{25L}$ WHERE: $Q =$ _____ AND $1.33 \frac{Q}{25L} =$ _____

$E = \frac{Q^2 K}{4.87L}$ WHERE: $Q^2 =$ _____ AND $\frac{Q^2}{4.87L} =$ _____

RECORD INTERVAL	RECORD DURATION	DEAUFORT SEA STATE	(h) GREATEST PK-PK	ERR. (COUNTS)	(K) 4.87L Q ² (COUNTS)	CALC. X _m (g-P)	CALC. E (g ²)	GROUP AVERAGE PK-PK
15	2-3	7	.30	0				.26
16	3-4	8	.57	3				.50
17	4-5	10	.37	2				.35
18	5-6	11	.91	1				.26
19	6-7-8	10	.33	0				.28
20	8-9	9	.21	0				.18
21	9-10	9	.32	0				.30
22	10-11	9	.30	0				.28

FIG. 23. SCHEMATIC OF ANALYSIS OF SLAM-INDUCED ACCELERATIONS.

was then laid over the record and the number of occurrences in each interval in excess of 0.35 g, and the maximum and next to largest peak-to-peak signal in the interval were recorded. These data were then added to the basic data sheet. Only the first 28 minutes of each interval was studied in order to be generally consistent with the analysis of wave-induced data. A more detailed study of one individual slam impulse was made and the results of this are presented in Figure 24.

VIII. RESULTS OF ANALYSIS

A. General

In presenting the results of an investigation such as this, it is not possible to include the "raw" data or even the "reduced" data in tabular form. This would have required the publication of some 70,000 pieces of information. Tabulations of the reduced data and of the work sheets are in the hands of the investigators and of the sponsors and are available to other qualified investigators upon request. For the present, it is necessary that this report include only the results of the entire study in summary form.

In the subsections to follow, the accelerometers will be referred to by a code combining position in the ship and direction of sensitive axis as shown in Figure 25. Sea state numbers are as described in Appendix C.

Data to be presented will include only acceleration information; application to prediction of cargo loads will be discussed in Section IX.

B. Wave-Induced Accelerations

Even though the investigation is concerned with long-term predictions, it is essential that the character of the short-term distribution of accelerations be established as noted in Section V. The data for all accelerometers are presented in Figures 26 through 32 for the first 24 minutes of interval number 45-46 of Voyage 175. The mean square value, E , which characterizes the Rayleigh distribution shown in each case is also listed as is the number of peak-to-peak signal counts considered in the analysis. Note that these curves are plotted as probability density.

As noted in Section V, a convenient method of presenting data of this type covering long periods is the log-normal plot of the root mean square parameter, \sqrt{E} , for each interval considered. These results for all accelerometers are presented in Figures 33 to 36. The curves include data from a total of more than 1000 intervals representing 4000 hours at sea during which the sea condition was such as to result in a finite value of E . For approximately 1000

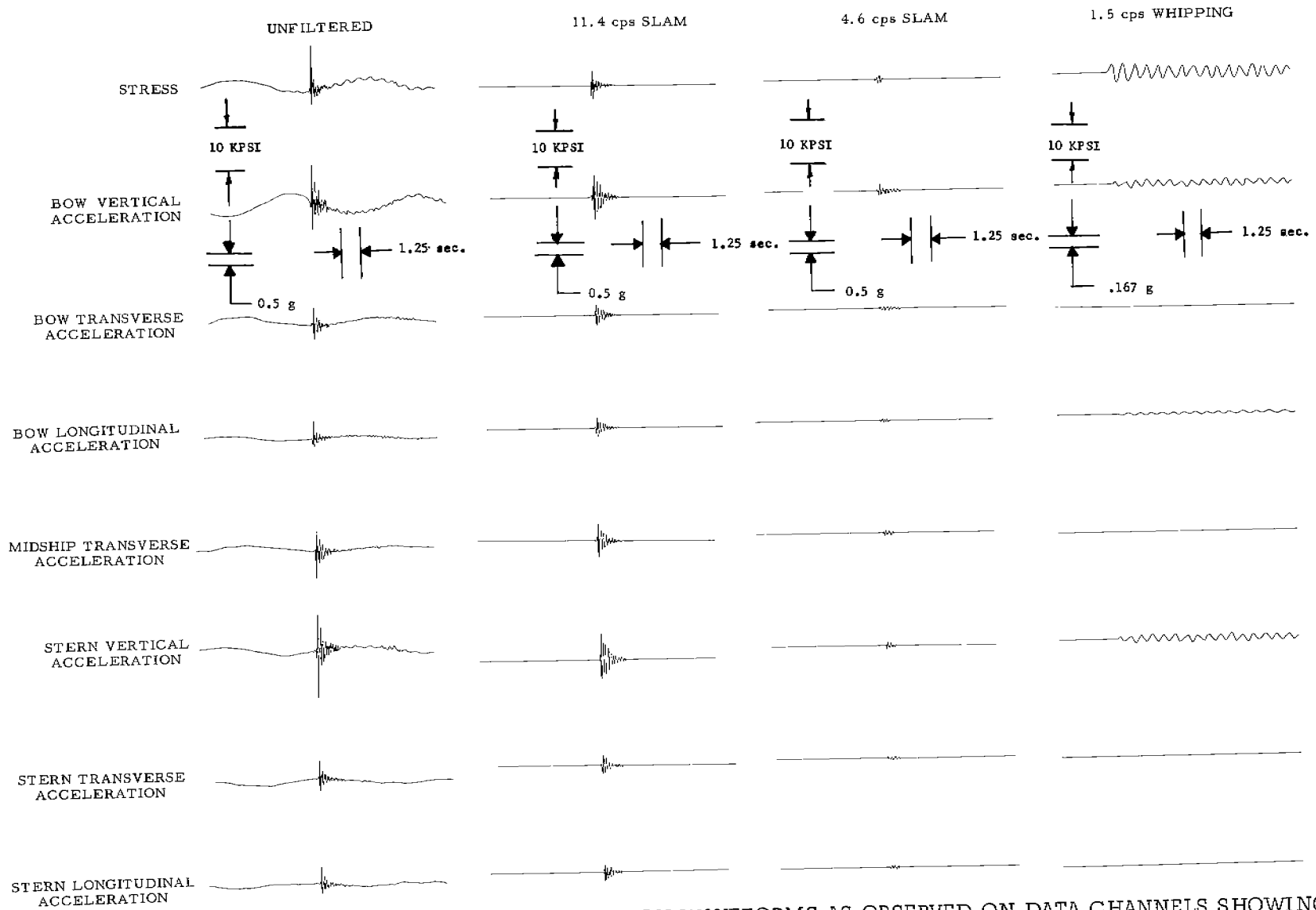
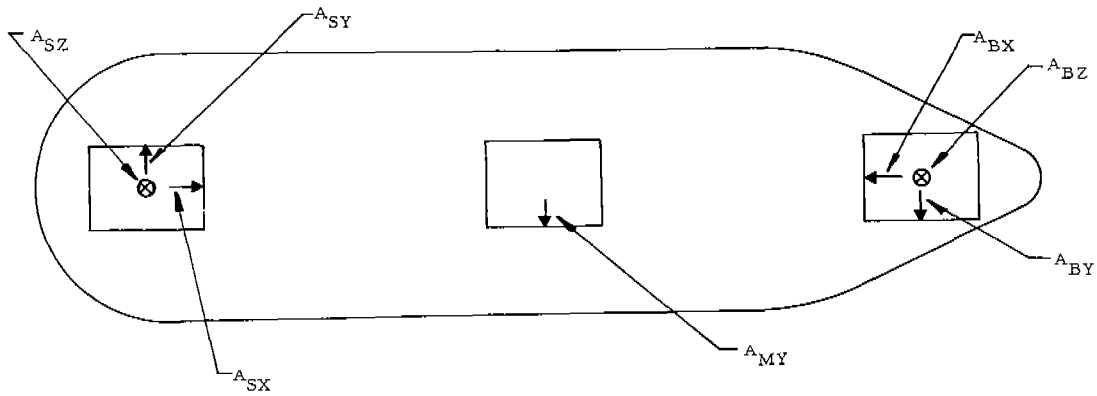

FIG. 24. TYPICAL COMPOSITE STRESS AND ACCELERATION WAVEFORMS AS OBSERVED ON DATA CHANNELS SHOWING RELATIVE MAGNITUDES OF MAJOR FREQUENCY COMPONENTS.



NOMENCLATURE OF DATA CHANNELS USED IN PRESENTATION

- | | |
|---|--|
| A_{BX} - Bow Accelerometer in the Longitudinal (Fore and Aft) Direction | A_{SX} - Stern Accelerometer in the Longitudinal Direction |
| A_{BY} - Bow Accelerometer in the Transverse (Athwartship) Direction | A_{SY} - Stern Accelerometer in the Transverse Direction |
| A_{BZ} - Bow Accelerometer in the Vertical Direction | A_{SZ} - Stern Accelerometer in the Vertical Direction |
| A_{MY} - Midship Accelerometer in the Transverse Direction | |

FIG. 25. PLAN VIEW OF SHIP SHOWING ACCELEROMETER LOCATIONS.

The summary plot on Figure 33 demonstrates that the bow vertical accelerometer (A_{BZ}) consistently recorded the highest signal values; subsequent analysis was therefore confined to this accelerometer in order to reduce the processing burdens.

Figure 37 shows the root mean square variation of bow vertical acceleration plotted as a function of sea state number obtained from the data log kept by the crew of the ship. Each data point characterizes a 30 minute recording interval, and presumably, a four hour period at sea. Again, the data include only time spent at sea. In Figure 38, the maximum peak-to-peak acceleration variation encountered in each interval is given as a function of sea state. Data from 1548 intervals, during which the vessel was in open seas, are presented. In both Figures 37 and 38, the crosses represent the average of all points in each sea state category. The maxima shown in Figure 38 are derived from the first 24 to 30 minutes of those intervals which ran longer than the basic 30 minute interval; it is possible that a higher value of variation occurred later in the interval. Little change in the rms data of Figure 37 would be expected to result from any increase in the analysis time on long intervals. The average frequency of the wave-induced data for the bow vertical accelerometer is given in Figure 39. Each point represents one recording interval. These figures were computed from the number of peak-to-peak variations detected by the probability analyzer during the specified analysis period.

C. Slamming, Pounding and Other Accelerations

Results of the analysis of accelerations other than wave-induced obtained as described in Section VII-B, are shown in Figures 40 through 42. These include plots of the greatest and second greatest peak-to-peak acceleration values (exclusive of wave-induced signal) and the number of "slams" exceeding 0.35 g's peak-to-peak,

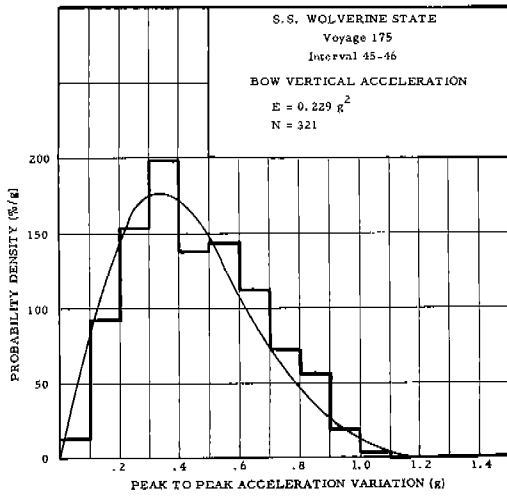

FIG. 26.

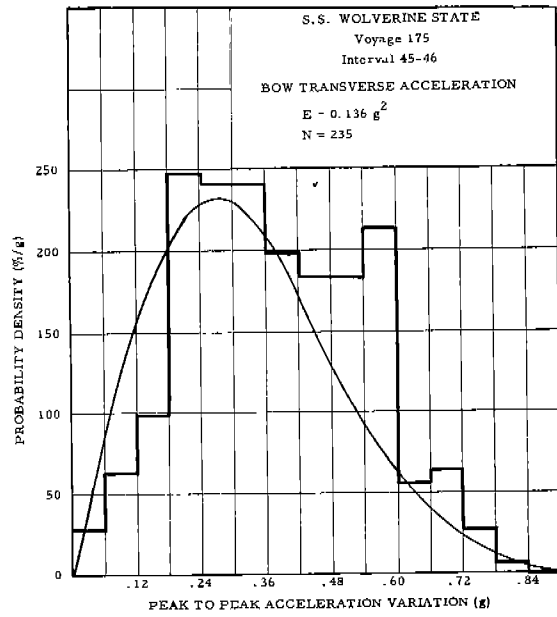

FIG. 27.

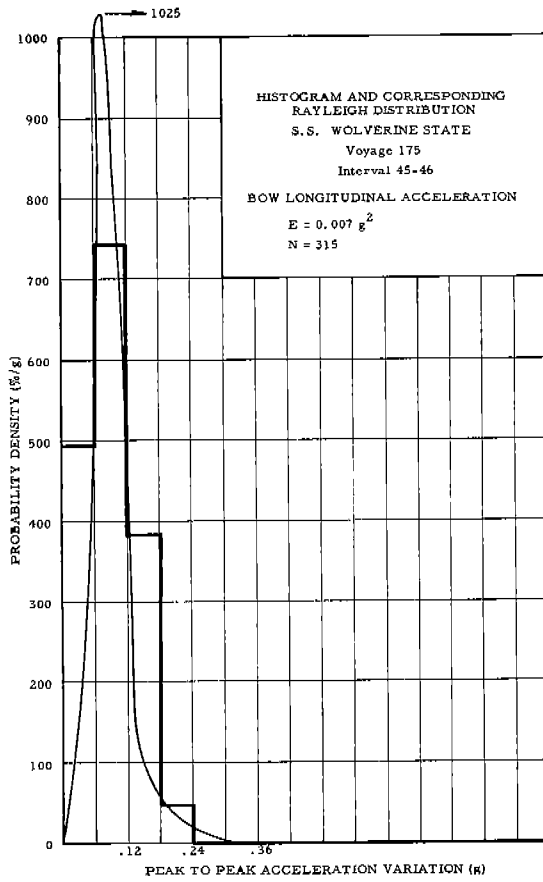

FIG. 28.

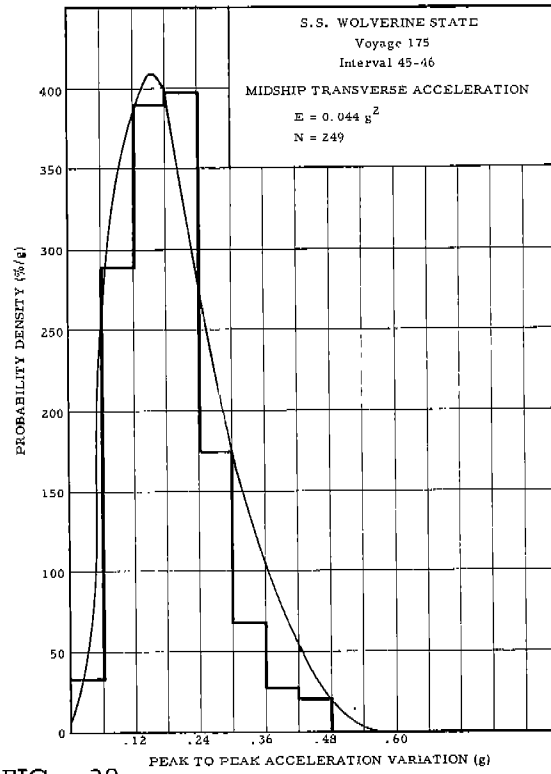

FIG. 29.

FIG. 26-29. HISTOGRAM AND CORRESPONDING RAYLEIGH DISTRIBUTIONS.

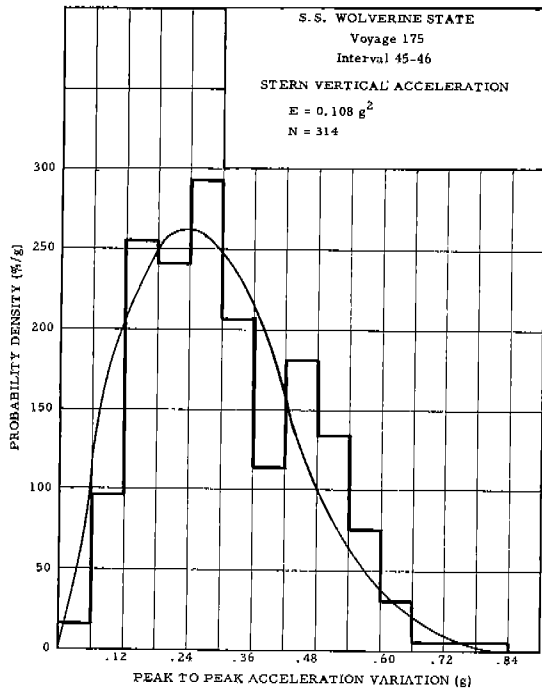

FIG. 30.

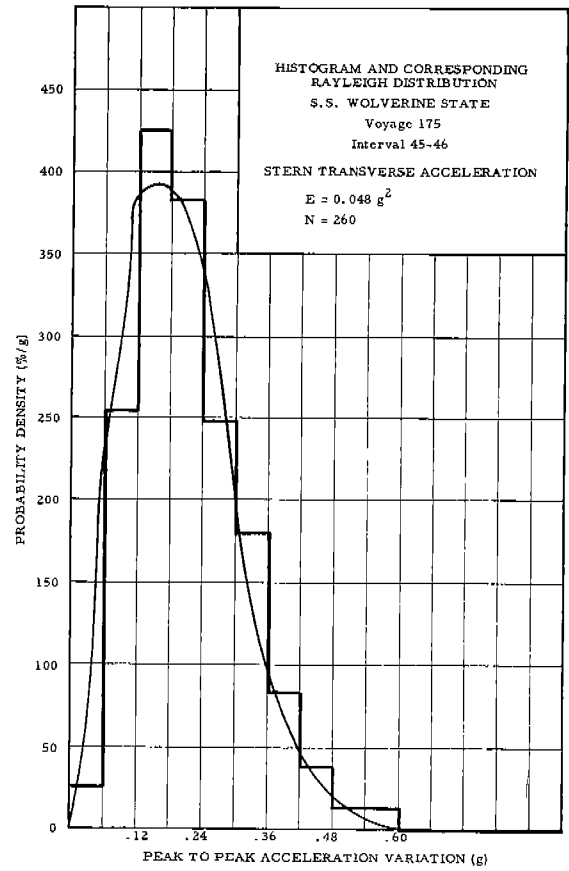

FIG. 31.

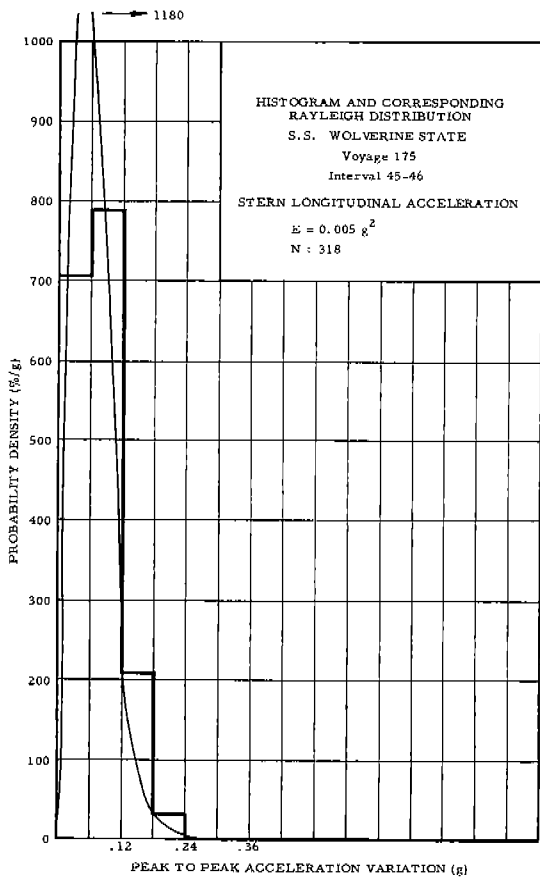

FIG. 32.

FIG. 30-32. HISTOGRAM AND CORRESPONDING RAYLEIGH DISTRIBUTIONS.

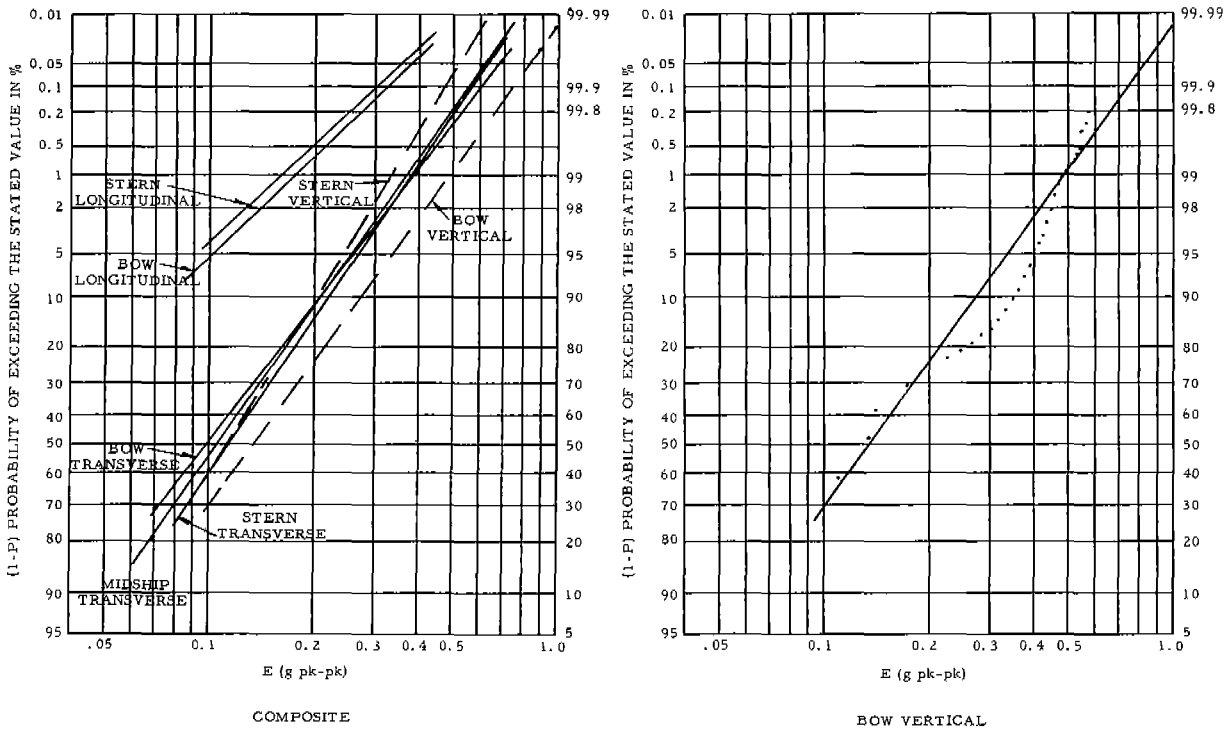

FIG. 33. COMPOSITE AND BOW VERTICAL ACCELERATION.

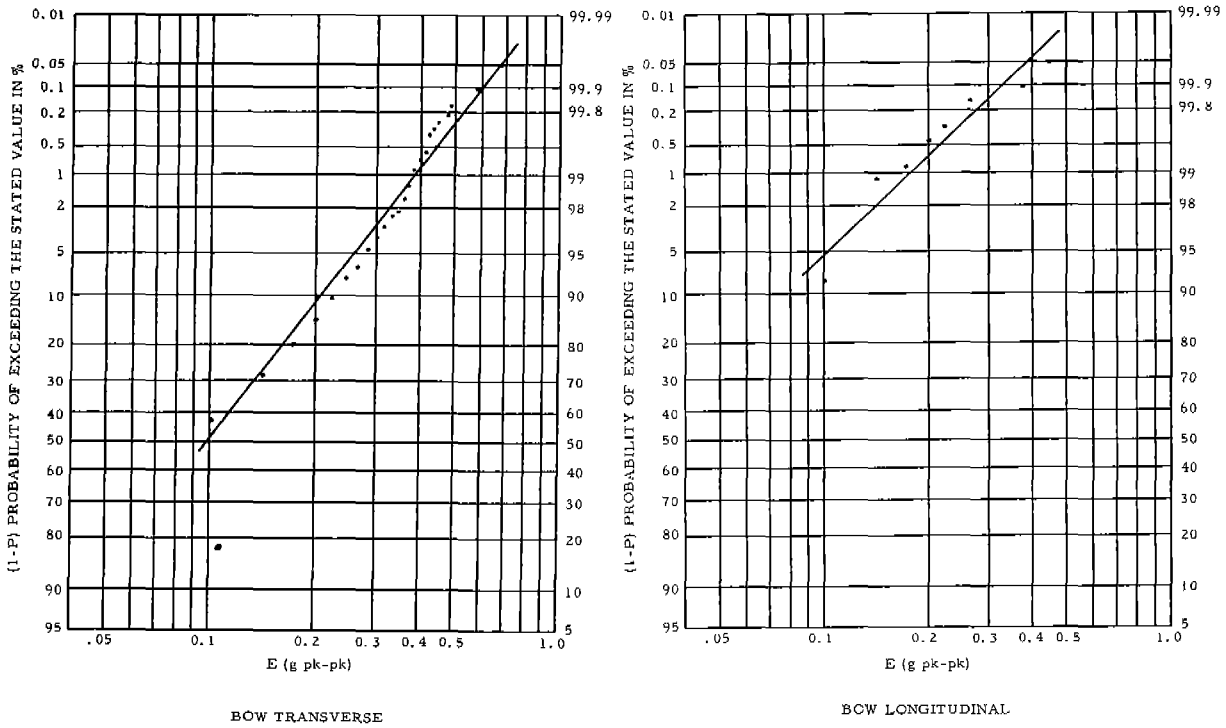

FIG. 34. BOW TRANSVERSE AND BOW LONGITUDINAL ACCELERATION.

FIG. 33-34. LONG-TERM PLOT OF R. M. S. ACCELERATION (\sqrt{E}) BASED ON DATA FROM 14 ROUND-TRIP VOYAGES.

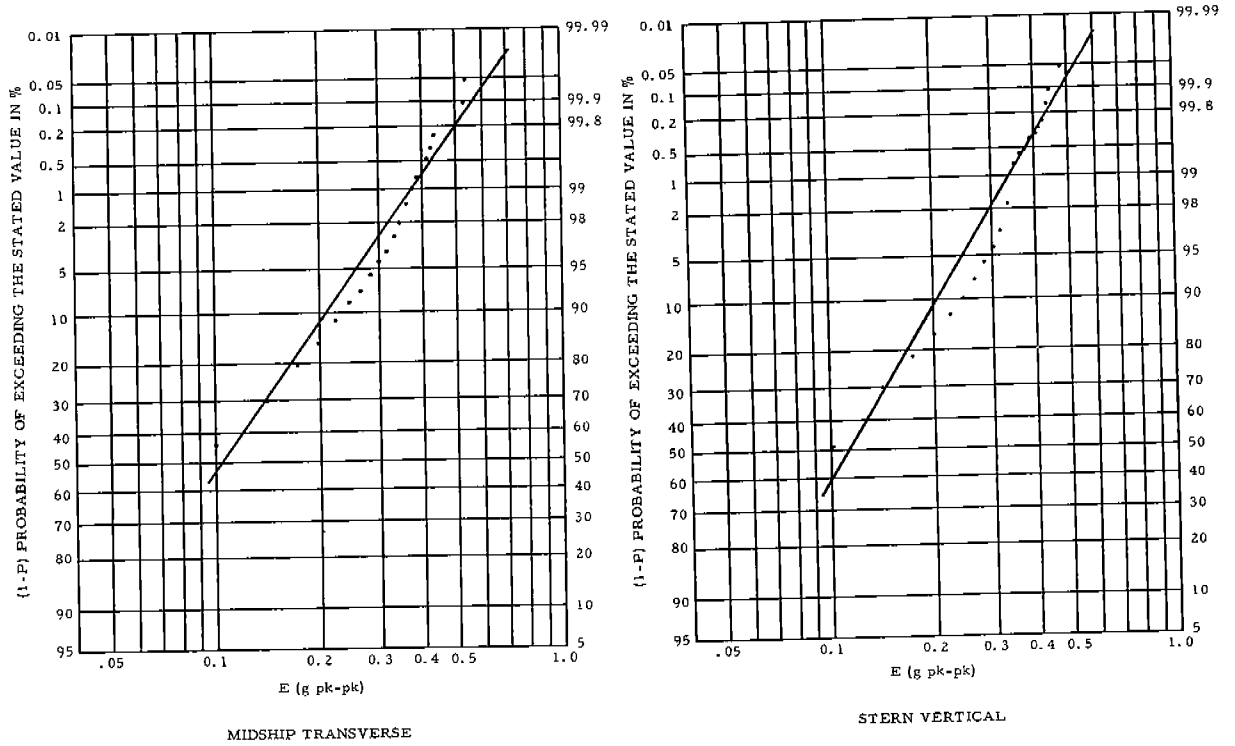

FIG. 35. MIDSHIP TRANSVERSE AND STERN VERTICAL ACCELERATION.

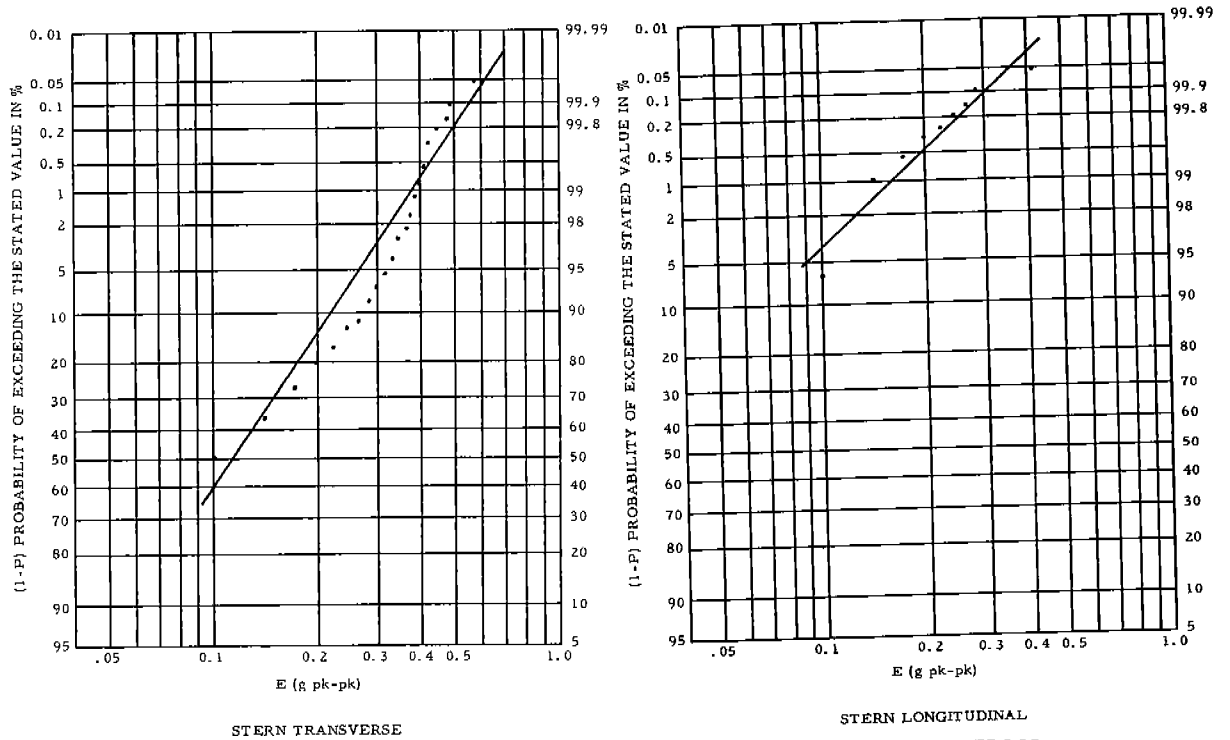

FIG. 36. STERN TRANSVERSE AND STERN LONGITUDINAL ACCELERATION.

FIG. 35-36. LONG-TERM PLOT OF R. M. S. ACCELERATION (\sqrt{E}) BASED ON DATA FROM 14 ROUND-TRIP VOYAGES.

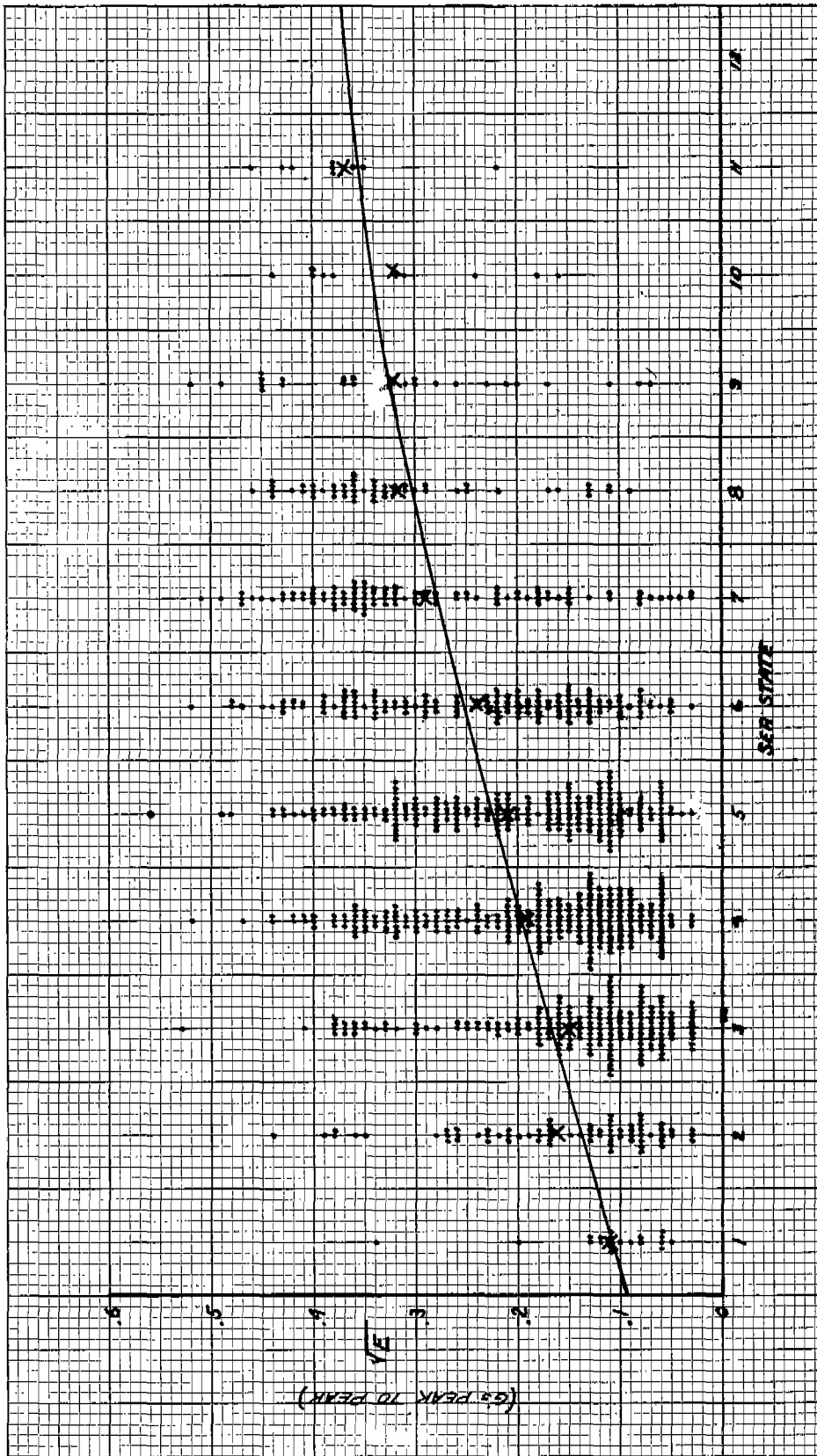

FIG. 37. R.M.S. VARIATION OF WAVE-INDUCED BOW VERTICAL ACCELERATION (\sqrt{E}) VERSUS BEAUFORT SEA STATE.

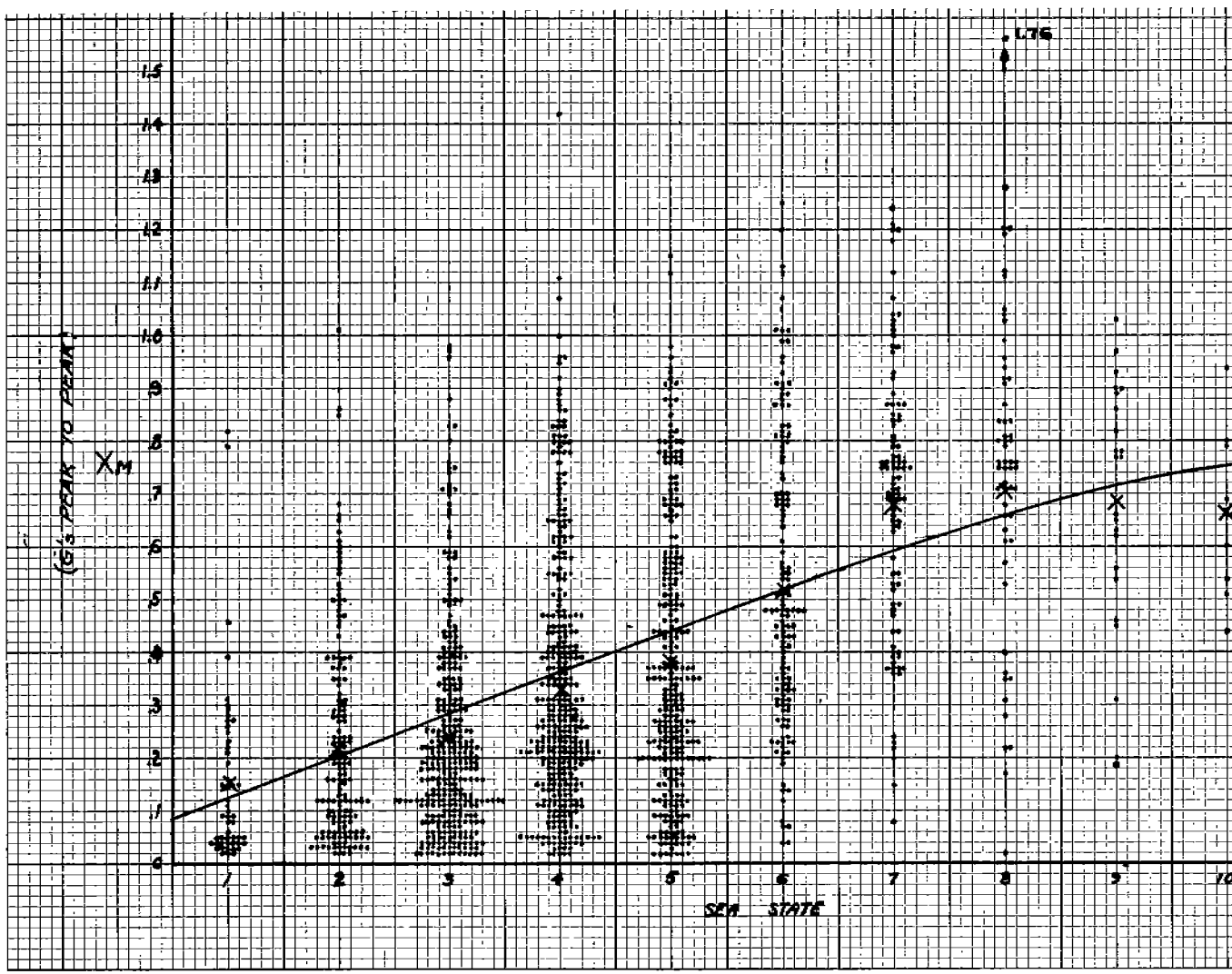

FIG. 38. MAXIMUM PEAK-TO-PEAK VARIATION OF WAVE-INDUCED BOW VERTICAL ACCELERATION BEAUFORT SEA STATE.

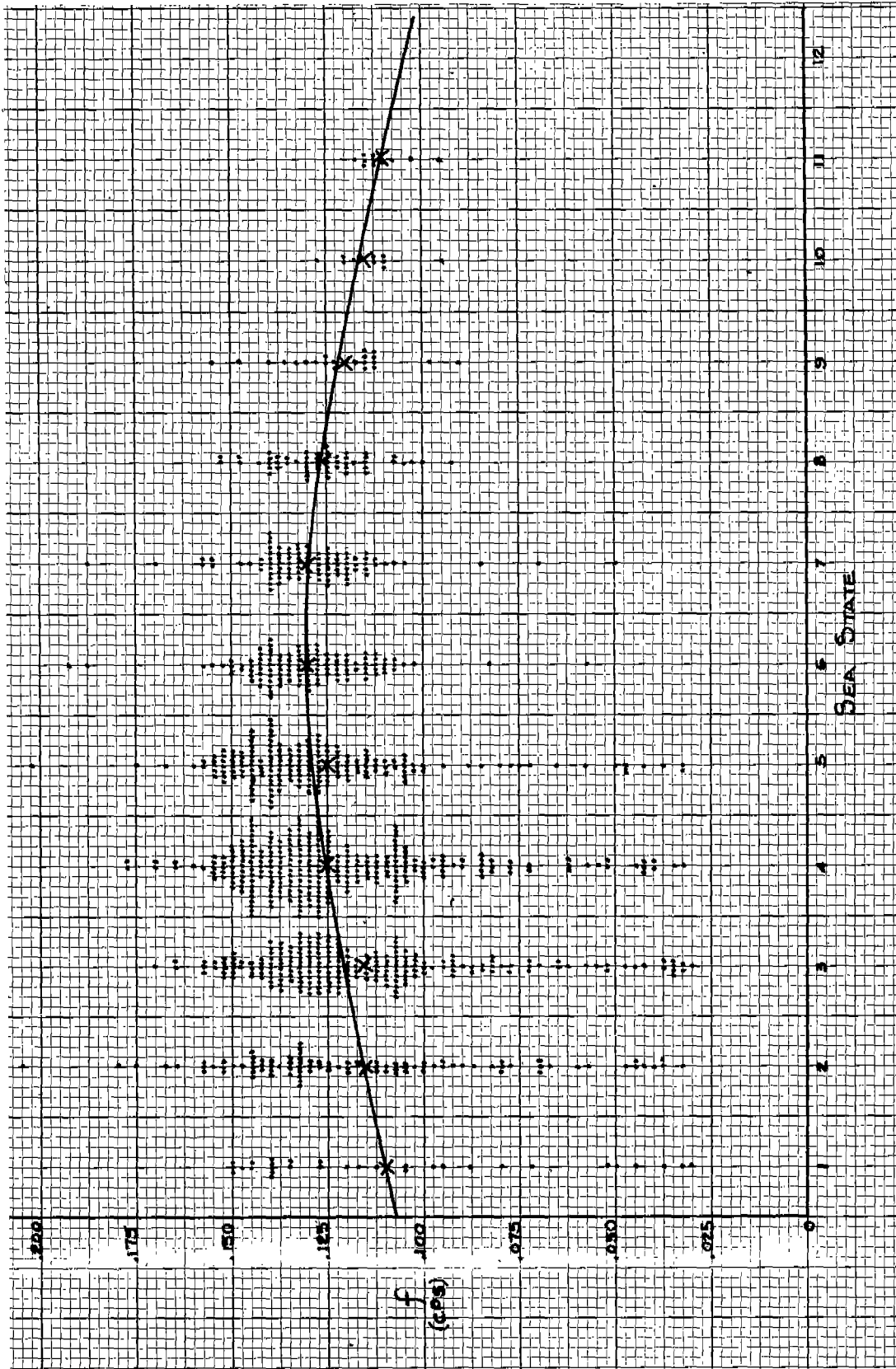

FIG. 39. AVERAGE FREQUENCY OF WAVE-INDUCED ACCELERATIONS VERSUS BEAUFORT SEA STATE.

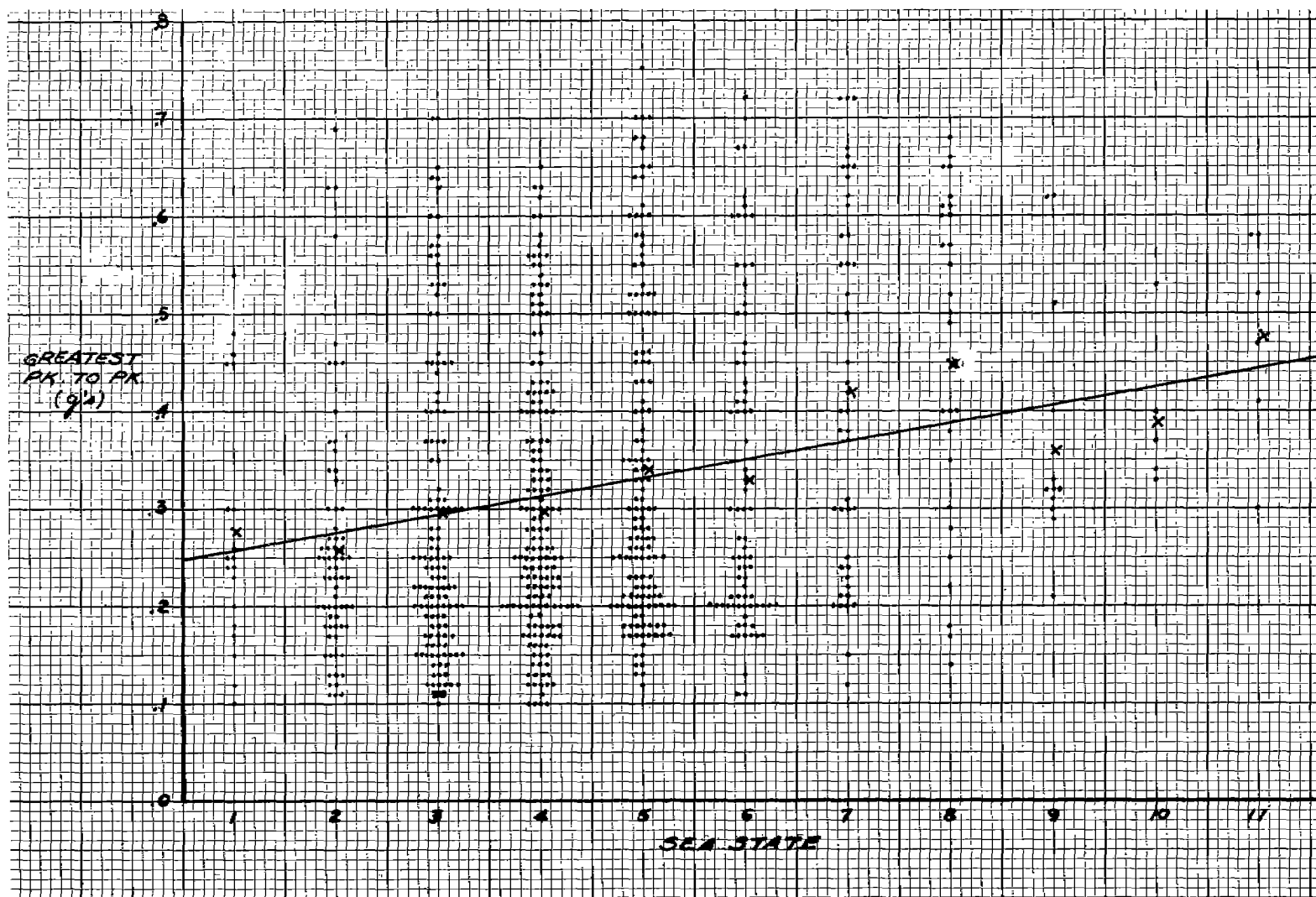
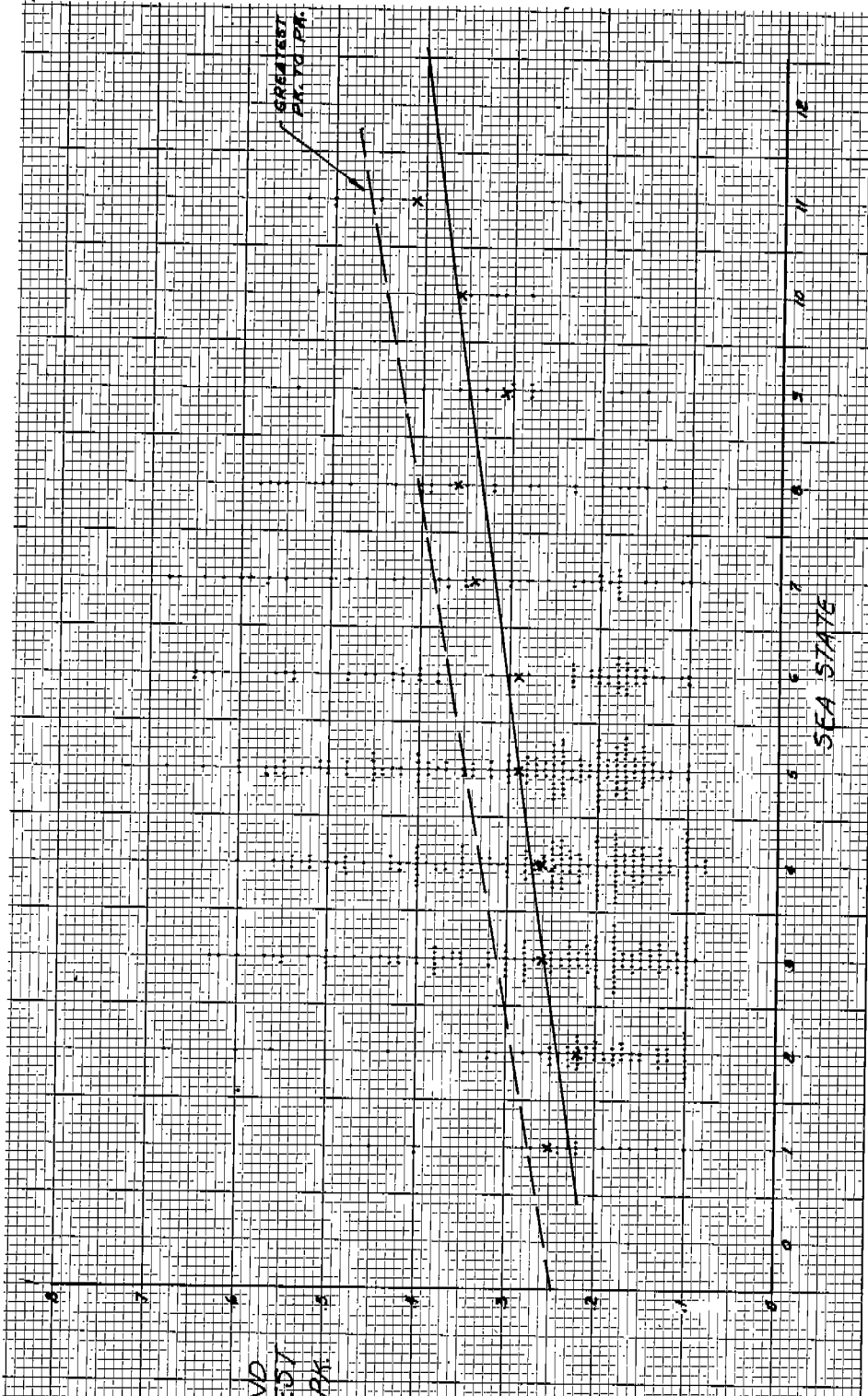
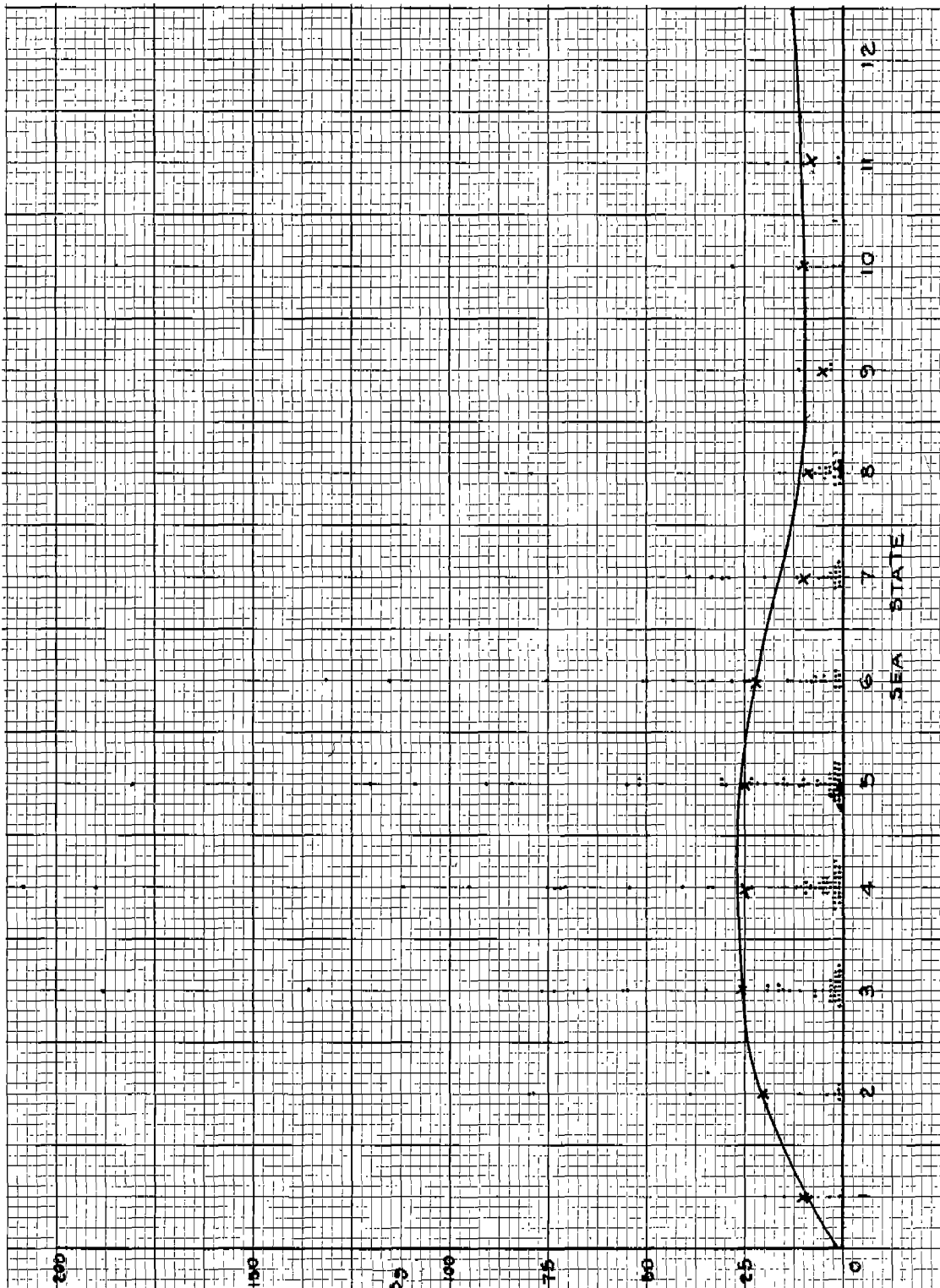

FIG. 40. GREATEST PEAK-TO-PEAK VARIATION OF SLAM-INDUCED BOW VERTICAL ACCELERATION VERSUS BEAUSEA STATE.



SECOND GREATEST PEAK-TO-PEAK VARIATION OF SLAM-INDUCED BOW VERTICAL ACCELERATION VERSUS SEA STATE.



NUMBER OF OCCURRENCES (Σn) OF SLAM-INDUCED VARIATIONS OF BOW VERTICAL ACCELERATION
G 0.35 g PEAK-TO-PEAK AMPLITUDE VERSUS BEAUFORT SEA STATE.

all on the bow vertical accelerometer and as a function of sea state. It will be noted that the number of data points on Figures 40 and 41 is less than for the corresponding wave-induced data plots. This resulted from the absence of significant "slam" data in a number of intervals, and the rejection of data from other intervals for reasons which will be described in the following section. The number of data points in Figure 42 is even further reduced by eliminating peak-to-peak bursts below 0.35 g.

D. Statistical Accelerometers

The data obtained on the statistical accelerometers are summarized in Table II.

IX. DISCUSSION OF RESULTS

A. General

Prior to discussion of the specific features of the data, a few general and some specific observations are in order relative to the reliability of the results already presented.

Three features of this type of project combine to make the investigators' task difficult, and it is with these firmly in mind from the very outset that the present study has been undertaken:

1. Direct calibration of the transducer and recording instrumentation, in situ, is not possible.
2. Signal conditioning equipment (including amplifiers, filters, frequency modulation and de-modulation units and so on) is required both to record and to play back and analyze the data signal.
3. The investigator is never present when useful data are being obtained, and is rarely present when the record instrument is in operation and the ship in motion. All final data inputs are provided by the data tape and the log book.

Through a combination of careful preventive maintenance of the equipment aboard ship, judicious selection of transducers and other components, and cross checking of data from voyage to voyage and with other similar data where available, it is felt that these difficulties have been minimized or eliminated, at least to the point where there is reason to have great confidence in the information contained on the magnetic tapes removed from the vessel at the end of each voyage. The only possible reservation in this observation has to do with the fact that low level electrical noise was detected at intermittent intervals during the investigation. Since means are available to separate valid data from the noise, this is an inconvenience rather than a major problem.

Peculiarly enough, the major problems were encountered in the analysis of the non-wave-induced data, or the data in the range of 1.3 to 35 cycles per second real time. Limitations on available time have left some of these problems unresolved, but the following

TABLE II. TABLE OF STATISTICAL ACCELEROMETER READINGS.

Serial No. Location	6773				6778				6779				6784			
	#1 UTD FWD.				#1 UTD AFT				#2 LTD				#2 HOLD			
Voyage 192-193	0.1	.25	0.5	1.0	0.1	.25	0.5	1.0	0.1	.25	0.5	1.0	0.1	.25	0.5	1.0
December 7, 1962	848	116	192	255	890	634	544	046	992	032	858	715	578	027	435	988
17	X	X	X	X	899	634	545	046	X	X	X	X	X	X	X	X
23	X	X	X	X	900	634	545	046	000	032	858	715	599	033	435	988
31	879	126	193	255	900	634	545	046	009	032	858	715	599	033	435	988
January 2, 1963	879	126	193	255	900	634	545	046	009	032	858	715	599	033	435	988
5	X	X	X	X	900	634	545	046	009	032	858	715	599	033	435	988
△	31	10	1	0	10	0	0	0	17	0	0	0	21	6	0	0
Voyage 194-195																
January 18	256	189	223	253	924	636	549	046	088	032	859	715	599	034	435	988
19	X	X	X	X	X	X	X	X	426	040	873	715	866	093	451	989
21	319	589	429	258	179	679	587	055	563	044	883	715	959	115	458	990
27	X	X	X	X	X	X	X	X	563	044	883	715	959	115	459	990
February 9	X	X	X	X	289	692	595	055	779	048	889	715	109	043	474	990
14	X	X	X	X	399	718	612	060	989	052	900	717	265	179	488	992
△	1063	400	206	5	475	82	63	14	901	20	41	2	686	145	53	4
Voyage 196-197																
February 24, 1963	X	X	X	X	X	X	X	X	989	052	900	717	266	180	488	992
27	X	X	X	X	X	X	X	X	989	052	900	717	266	180	488	992
March 1	X	X	X	X	X	X	X	X	989	052	900	717	266	180	488	992
11	X	X	X	X	X	X	X	X	999	052	900	717	266	180	488	992
15	X	X	X	X	X	X	X	X	010	052	900	717	271	181	488	992
26	384	498	852	268	502	730	619	060	489	054	910	717	715	289	501	993
△	1065	909	423	10	103	12	7	0	500	2	10	0	449	109	13	1
Voyage 198-199																
April 22	603	601	896	268	559	737	621	060	530	054	913	717	795	304	509	993
△	219	103	44	0	57	7	3	0	30	0	3	0	80	15	8	0
Voyage 200-201																
May 27	232	669	919	267	579	737	621	060	570	054	915	717	850	308	509	993
△	629	68	23	-1	20	0	0	0	40	0	2	0	55	4	0	0

X - Inaccessible due to cargo

observations may serve to place the detailed discussions to follow in proper context. The tape playback, amplification, filtering, and oscillograph system used to develop the quantitative data for the "slam" plots introduced a long chain of devices, each with unique gains and band pass characteristics, between magnetic tape and observer.

As a result of frequent checks, there is reason to believe that the bulk of the slam data is reliable; some is subject to question largely because of the low levels of filtered higher frequency signal, particularly in intervals when expanded print-outs of the data have clearly shown bursts of substantial magnitude.

The problem would not have arisen except for the attempt to compress the filtered slam information for one interval onto approximately six inches of chart; no problem of interpretation exists if the same interval is expanded to several hundred inches of record, but then the inspection of several thousand intervals becomes an impossible task.

There is every indication - both on an absolute and on a comparative basis - that the wave-induced data are reliable.

In summary, it can be stated that there is reason to have confidence in all of the data presented with the exception that some reservations still exist on the "slam" data. Further study of the signals and of the analysis system are expected to show that some additional slam signals of higher magnitude than those obtained to date should be included in the plots. The present data are therefore unconservative in this respect.

B. Wave-Induced Data

The experimental data of Figures 26 and 32 demonstrate a satisfactory correlation with the Rayleigh distribution. This confirms the work of previous investigators and no further concern will be devoted to short-term distributions.

The long-term plots of root-mean-square variations (Figures 33 to 36) particularly for the vertical and transverse accelerometers, show the characteristic departure from the straight line noted by previous investigators (3,4). It is still felt that the log-normal distribution can be used to good advantage as a first approximation for long-range predictions recognizing that it is likely to yield conservative (high) values of the variate in the case of seaway-induced effects at low values of probability of exceedance.

From the combined plot of data from all accelerometers, Figure 33, there appears to be every justification for basing future comparative calculations on the bow vertical accelerometer. It is interesting to note that additional data and refinement of the data reduction would probably emphasize the differences between bow and stern transverse accelerations. The observed differences can be ascribed to the addition of yaw and roll accelerations at one end of the ship (stern) and subtraction at the other (bow). The fore-and-aft accelerations are of sufficiently small magnitude, compared to the others, to be neglected in future studies of wave-induced effects. Note that the ratio of maximum peak-to-peak accelerations in an

interval are directly proportional to the ratio of the root mean square variations shown for the same numbers of cycles indicating that the fore and aft values are something like 40% of the bow vertical.

To appreciate the manner in which the log-normal data can be used to determine the most probable maximum value of peak-to-peak bow vertical acceleration to be encountered during a given period, consider the following example:

Assume that the ship sails 24 hours per day, 20 days per month, which is a total time of 5760 hours in a year. During this year, the worst single variation of peak-to-peak acceleration that the ship encounters will be expected to occur during one of the four hour periods represented by a 30-minute data sample. The probability of occurrence is then:

$$4/5760 = .000694 \text{ or } .0694\%$$

For the 15 month data period of the S. S. WOLVERINE STATE under consideration, the probability of occurrence is then:

$$(4/5760) (12/15) = .0556\%$$

From the long-term plot of bow vertical accelerations, (Figure 33) at $(1-P) = .0556$, $\sqrt{E} = .82 \text{ g}$.

The most probable maximum value, x_m , can be determined from the relationship (See Section V):

$$x_m = \sqrt{E} \sqrt{\ln N}$$

where N is the number of wave-induced variations expected during the four-hour period.

From references 3 and 4:

$$N = \text{Four Hours} / T$$

where T is the period or mean between the periods of the shortest and longest waves.

The period, T, is calculated from the relationship:

$$T^2 = L/5.12$$

where L is determined from:

$$1/\sqrt{2} \text{ LBP} \leq L \leq \sqrt{2} \text{ LBP}$$

(LBP is the Length Between Perpendiculars, in feet, of the ship.)

The LBP for the S. S. WOLVERINE STATE is 496.0 feet, then:

$$351 \leq L \leq 702$$

and from the above

$$8.26 \leq T \leq 11.8$$

$$\text{or } T = \frac{11.8 + 8.26}{2} \approx 10 \text{ seconds}$$

then $N = \frac{4(3600)}{10} = 1440$ for a four hour interval.

With N and E determined, the most probable maximum value is:

$$x_m = \sqrt{E} \sqrt{\ln N} = (.82) (2.7) = 2.21 \text{ g. (peak-to-peak)}$$

This indicates that a ship of this type sailing in the North Atlantic for 15 months probably will not encounter a bow vertical acceleration variation greater than 2.28'g. * This predicted value can be compared with the actual data by arranging the calculation to predict the most probable maximum variation we would observe if we looked at only one-half hour of the four hour interval having the specified maximum mean square value. Dividing N by 8 and taking $N' = 180 \ln N' = 5.2$.

$$x_{m'} = (.82) (2.28) = 1.87 \text{ g (peak-to-peak).}$$

This compares to the observed maximum value of 1.76 g peak-to-peak, a difference of less than 6%.

The calculation of N above is based on the assumption that the worst acceleration is induced by waves of length about equal of ship length (.707 to 1.414 times ship length). Based on experience to date, the number of wave encounters has, in general, been greater than the N predicted above. For instance, during the interval 61-62, Voyage 173, 908 cycles of acceleration occurred during 80 minutes of recording time. This would imply a total of 2700 cycles in four hours.

$$\text{Using } N = 2700 \text{ and } \sqrt{E} = .82$$

$$x_m = 2.30 \text{ g}$$

$$\text{Even taking } N = 4000, x_m = 2.36 \text{ g}$$

Thus multiplying the anticipated number of cycles by a factor of nearly 3 results in only a 5% increase in most probable maximum acceleration variation.

Considering seven years as a convenient example of a long-term prediction of x_m :

$$(1-P) = (4/5760) (1/7) = .00992\%, \text{ say } .01\%$$

$$\text{and } \sqrt{E} = 1.1$$

* It must be borne in mind that this is a most probable maximum. The "maximum" value on a Rayleigh curve also has a distribution so that maximum values higher or lower than this can also occur.

then

$$x_m = \sqrt{E \sqrt{\ln 1440}} = 2.97 \text{ g (peak-to-peak)}$$

The plot of RMS variation against sea state (Figure 37) is the first step in the method of analysis proposed in reference (6). It is included herein for comparative purposes only since the complete analysis requires rather complex digital computer techniques. The general shape of the average line is the same as that found in reference (6) for wave-induced stresses. Bennet and Lewis (6) assume, however, that their rms stress values are normally distributed about this mean line within each sea state. This would, on inspection, appear to apply only to the acceleration data at sea states 5 and above; the data appear more Rayleighian at sea states 1 through 4. These comments apply generally to Figure 38 for the maximum bow vertical acceleration variation. In addition, it will be noted that the larger values of both variables occur in the lower sea states, even though the mean lines increase fairly monotonically up to sea state 11. This is, of course, related to the relative frequency of encounter of the "moderate" and high sea states. In attempting to relate the encounter frequency for various sea states as shown in the figures, to other data on the North Atlantic, the fact that States Marine Lines subscribe to a weather routing service must be considered. This in no way alters the validity of the data presented, but would tend to reduce the relative number of encounters with heavy seas.

The maximum observed variation during the 15 month period (see Figure 38) was 1.76 g's and, interestingly enough occurred in what was considered to be a state 8 sea.

Figure 39 demonstrates that the bulk of the wave-induced bow vertical data fell in the frequency range of 0.10 to 0.15 cycles per second (6 to 9 cycles per minute, or periods between 6 and 10 seconds). It is possible that some of the extremely low frequencies resulted from relatively calm periods. In this case, the probability analyzer would not record values below the minimum threshold (.01g), and thus present an unreasonably low total number of variations for the interval.

C. Slam, Pound, and Vibration

An understanding of the behavior of the ship and of the analysis problem when considering slam and related accelerations can be best obtained by inspection of Figure 24 and the presentation of some auxiliary data based on detailed analysis of a number of intervals having characteristics similar to those shown in Figure 24.

The outstanding feature from the figure is the large signal component at 11.4 cps, particularly in the acceleration signals. Past experience with midship stress data has shown that the "slam" is a gentle spike followed by a damped vibration at the first hull mode. This was found to be about 1.5 cps for the WOLVERINE STATE from inspection of stress records. Acceleration records, on the other hand, (and in particular, the bow vertical accelerometer) would be expected to show a sharper initial spike of high frequency (10 cps or above) which damped very quickly and would be followed by the first mode whipping.

It soon became apparent that the effect of the initial "slam" or motion of the bow downward into the water on the WOLVERINE STATE was to excite some higher hull mode which lead to the possibility of the excitation arising from other sources. Analysis of a number of such "slams" resulted in the observation that the largest component occurs at 11.4 cps as noted, and that this is probably the natural frequency of one of the higher hull flexurel bending modes (seventh or ninth) based on 1.5 cps as the first. This is confirmed by the observed phase relationships (in phase) between the bow and stern vertical components. Furthermore, it is interesting to note that the vessel carries a four-bladed propeller operating in the range 80 to 85 rpm. Some second order propeller excitation would then fall in the range of 10.7 to 11.3 cps, and could contribute to the observed effects. This argument is reinforced by the fact that the initial large spike on the stern vertical accelerometer was in some cases slightly larger than the bow vertical spike which was, however, always preceded by a small signal indicative of the entry of the bow into "hard" water.

As the bow is descending into the water, the stern is rising, bringing the propeller closer to the surface. This may well account for the excitation, and if some slight speedup of the propeller occurs at this time, the observed frequency ratios come even closer together.

Comparisons of data from the accelerometers and the stress gage amidship are complicated at such high bending modes because the precise position of the nodes is not known. However, an approximate analysis has demonstrated that the first mode could easily result in the observed relatively higher stress signal (compared to bow vertical acceleration, and both compared to respective wave-induced components) whereas the ninth mode at the substantially higher frequency would result in proportionately stronger bow vertical acceleration.

Consideration of the transverse and fore and aft signal levels leads to the further supposition that torsional effects are also involved.

In any case, it is apparent that slam, pound, whipping, or other excitation results in accelerations of substantial magnitude compared to seaway-induced accelerations, and that the significant components of these accelerations fall into narrow frequency bands. This observation, of course, complicates the situation from a broad analytical point of view: the wave-induced data can be extended to all similar vessels and, with some slight additional work, it is hoped to all vessels and trade routes; the slamming data are peculiar to the particular vessel and, in the extreme, may be quite dependent upon lading, speed, and so on to the extent that generalization or extrapolations are of little value. Unless the higher frequency components of acceleration are positively shown to be of no concern in generalizing cargo damage, it is necessary that all investigators take care to assure faithful recording and reproduction of these components.

D. Statistical Accelerometers

In reviewing the statistical accelerometer data of Table II, it should be remembered that the purpose of this phase of the investigation was to establish whether or not the vertical accelerations in

the bottom of the vessel at about the forward quarter point (where bottom slamming damage usually occurs) were higher than those at the actual forward instrument location, which was comparatively high in the ship. In Table II, the unit identified as "#2 Hold" was mounted at the location of primary interest, and "#1 UTD FWD" was mounted near the forward strain gage accelerometer housing. (See also Figure 17.)

It was not possible for the crew to read the accelerometers at frequent enough intervals to establish the number of times the counters re-cycled at the lower levels - particularly 0.1 g and 0.25 g. The counters run to 999 and start again at 000. In recording incremental counts in the lowest level, it can be seen that some assumptions were required at the 0.1 g level in order to provide data compatible with the counts registered at the 0.25 g level since the counters are energized cumulatively (i. e. , a 0.5 g count will register on both the 0.1 and 0.25 g counters).

Considering only the 0.5 and 1.0 g levels where the total recorded increments are not as subject to errors of interpretation, it is apparent that the #1 UTD unit consistently showed more counts than any other unit with the one possible exception of the #1 UTD AFT counter, Voyage 194-195 in the 1.0 g level. In this instance, final readings on the #1 UTD FWD unit were not possible, but there is every reason to suspect that, had they been made, the point would have been unanimously demonstrated.

The results of this study would indicate that the vertical accelerations at the location of the forward strain gage accelerometer housing were more severe than those at the other statistical accelerometer locations, and would tend to fortify the original decision regarding placement of the strain gage accelerometers.

E. Application to Cargo Loads

Any general statement relative to the predictions of extreme values of seaway-induced cargo loads would obviously be premature at this time for a number of reasons, most of which have been mentioned at one time or another in previous portions of this report. Recognizing the limitations imposed by the single ship-type, trade route, and specific accelerometer locations, and the use of unrefined statistical techniques where used at all, it still seems in order to demonstrate the means whereby the type of information being obtained can be of assistance in the solution of the general problem implied in the objective of the work.

Two situations were identified in Section V-D - one related to low frequency, wave-induced accelerations, and the other with higher frequency components. Considering the former first, it can be seen that the methods of sub-section IX-B above and refinements suggested thereto can be used to predict a most probable maximum value of wave-induced acceleration. This, when combined with knowledge of cargo stacking practice, can be used either to design the cargo containers for a wide range of possible situations, or can be used to limit the stacking of existing containers. At this time, it seems safe to predict that further study will indicate that the "g" value to be used in such a design analysis will be at least 3 g's peak-to-peak or 1.5 g's single amplitude in both the vertical

and transverse directions of the ship, and about 40% of these values in the fore-and-aft direction.

The data required to cope with the higher frequency components probably has less emphasis on magnitude of acceleration and more on frequency. Knowing that excitation of substantial magnitude (acceleration-wise, but not necessarily displacement-wise) is present, it is necessary only to specify frequency in order to develop the means to provide safety for a given cargo at sea. Referring to Figure 4, and recalling data from prior discussions, it would appear desirable to provide effective isolation of the cargo unit from the 5.5 cps and 11 cps components of acceleration with the higher frequency component being the greatest potential offender. Selection of a natural frequency of the mount between 2 and 4 cps would accomplish two things: it would avoid resonance at the first hull mode of 1.5 cps; and it would place the 11 cps excitation well out on the lower reaches of transmissibility curve.

Repeating the caution expressed at the beginning of this discussion: these can only be considered as examples until more generalized data covering a number of ship-types and trade routes are made available for statistical analysis.

X. ACKNOWLEDGEMENTS

This work has been sponsored by the Army Transportation Corps through Bureau of Ships, Department of the Navy, Contracts NObs-77139 and NObs-88451. Advisory guidance has been provided by a Project Advisory Committee of the Committee on Ship Structural Design of the National Academy of Sciences - National Research Council. Messrs. Robert Meldrum and Robert Kennedy of the Army Transportation Corps have provided invaluable assistance and guidance in relating the special features of this program to the overall ATC study. The wholehearted cooperation of States Marine Lines, and in particular, Messrs. E. P. Bainbridge, Neil Miller and the officers and men of the S.S. WOLVERINE STATE, has been a major factor in the success of the investigation to date. The contribution of States Marine Lines in the form of instrument installation is greatly appreciated.

XI. REFERENCES

1. Kennedy, Robert, "A Comparison of Shock and Vibration for Air, Rail, Sea and Highway Transportation," paper presented at the 31st Shock and Vibration Symposium, Phoenix, Arizona, 31 October 1962.
2. Fritch, D. J. and Bailey, F. C., "An Unmanned System for Recording Stresses and Accelerations on Ships at Sea," Ship Structure Committee Report SSC-150, In publication, to be available from the Office of Technical Services, U. S. Department of Commerce.

3. Jasper, N.H., "Statistical Distribution Patterns of Ocean Waves and of Wave-Induced Ship Stresses and Motions With Engineering Applications," Transactions SNAME, Volume 64, (1956).
4. Jasper et al, "Statistical Presentation of Motions and Hull Bending Moments of Essex-Class Aircraft Carriers," Department of the Navy, David Taylor Model Basin, Report 1251, June 1960.
5. Bennet, R., Ivarson, A., and Nordenstrom, N., "Results from Full Scale Measurements and Predictions of Wave Bending Moments Acting on Ships," The Swedish Shipbuilding Research Foundation Report No. 32, 1962.
6. Bennet, R., and Lewis, E. V., "Memorandum of Analysis of Stress Data from S.S. WOLVERINE STATE," Webb Institute of Naval Architecture, 21 September 1962.
7. Longuet-Higgins, M.S., "On The Statistical Distribution of the Heights of Sea Waves," Journal of Marine Research, Volume XI, Number 3, 1952.
8. Bennet, R., "A Comparison of Measured and Statistically Calculated Wave Stress Distributions using Data from Four Voyages of S.S. WOLVERINE STATE" Webb Institute of Naval Architecture Memorandum dated February 21, 1963.

APPENDIX A

DETAILED SPECIFICATIONS OF DATA ACQUISITION SYSTEM COMPONENTS

1. Accelerometers

Manufacturer: Statham Instruments, Inc.
12401 Olympic Boulevard
Los Angeles 64, California

Model: A3-2.5-350
Range: + 2.5 g
Nominal Bridge Resistance: 350 ohms
Maximum Excitation: 11 volts d-c or a-c (rms)
Full Scale Output (open circuit): + 20 mv.
Approximate Natural Frequency: 55 cps
Damping (Viscous Fluid): 0.7 + 0.1 critical at room temperature
Direction of Sensitivity: Perpendicular to base
Overload: Three times rated range
Transverse Acceleration Response: 0.02 g per g up to rated
range
Nonlinearity and Hysteresis: Less than + 1% of full scale
Output
Weight: Approximately 2 1/2 ounces

2. Accelerometer Amplifiers

Manufacturer: Statham Instruments, Inc.
12401 West Olympic Boulevard
Los Angeles 64, California
Model: CA9-56 Strain Gage Signal Amplifier
Power requirements: 30 milliamperes at 28 volts DC \pm 10%
Output: -2.5 to + 2.5 DC
Transducer excitation: 4.5 to 5.5 volts peak-to-peak
(square wave)
Frequency: 10 kc
Frequency response: Flat \pm 5% (referenced to DC), from
zero to 2000 cps
Ripple: Less than 0.15% rms
Sensitivity: Designed to operate with transducers with
rated sensitivity from 1.5 mv/v to 10 mv/v
Balance control: From -2.5 to + 2.5 volts d-c
Gain Stability: \pm 0.4% over a period of 8 hours after 15
minute warmup
Input Impedance: Designed to operate with transducers with
bridge resistance greater than 200 ohms
and less than 500 ohms
Output Impedance: Less than 4,000 ohms (100 K ohms
minimum recommended load)
Non-Linearity and Hysteresis: Less than + 0.3% of full scale
Temperature range: Operating -65°F to $+180^{\circ}\text{F}$
Non-Operating -75°F to $+230^{\circ}\text{F}$
Thermal coefficient of sensitivity: 0.015% per degree F
Thermal zero shift: + 0.005% of full scale output per degree F
Vibration tolerance: Constant displacement of 0.75 double
amplitude from 5 to 30 cps. Constant
acceleration of 35 g from 30 to 2,000 cps.
Vibration applied along any major axis.
Static acceleration: 100 g along any major axis

3. Tape Recording System

Manufacturer: Minneapolis-Honeywell Regulator Company
Heiland Division
4800 East Dry Creek Road
Denver 10, Colorado
Tape Transport: Type 3167, 0.3 and 0.6 ips tape speed
for one inch tape, 10 1/2" reels
Recording Head: IRIG Standard record head stack assembly
(two heads interleaved, 14 tracks per inch)
14 tracks
Recording Oscillator: Dual FM Recording Oscillator, Type 4206
0.27 kc center frequency
System Performance:
Input Level: 0.5 to 25 volts rms for \pm 40% carrier
deviation. Adjustable by means of front
panel control.
Input Impedance: 10,000 ohms, unbalanced to ground
Frequency Response and
Signal/Noise Ratio: DC-50 cps, 0.27 kc, 36 (com-
pensation improves S/N ratio
by 20 db)

Total Harmonic Distortion: Less than 2%
DC Linearity: No more than 0.5% deviation from best
straight line (+ 40% deviation system)
Drift Sensitivity: Less than \pm 0.2% of full scale in six
hours after 1/2 hour warmup
DC Drift: No more than 0.2% of full scale per hour warmup
(+ 40% deviation system)
Output Level: 4 volts peak maximum for full scale
deviation
Output Current: 30 milliamps maximum (standard output)
Output Impedance: Less than 1 ohm
Output Characteristics: Balance, short-circuit proof; can
be operated with one side grounded.
Output returns to zero with no in-
put signal present (squelch) or
with over-modulation (adjustable
from \pm 50% deviation) for oscillo-
graph galvanometer protection.
Low Pass Filters: Type 5232, Flat Frequency Response:
dc to maximum specified cutoff fre-
quency, + 0.5 db overshoot unspecified.

4. Statistical Accelerometers

Manufacturer: Inertia Switch Inc.
311 West 43rd Street
New York 36, New York

Range: 0.1, 0.25, 0.5, 1.0 g
Accuracy: \pm 5%
Frequency Response: 0 - 40 cps
Temperature Range: -65°F to +250°F
Sensitivity: Unidirectional, in arrow direction.
Weight: Approximately 1 3/8 lbs.

APPENDIX B

DETAILED SPECIFICATIONS OF DATA REDUCTION SYSTEM COMPONENTS

1. Magnetic Tape Playback System

Manufacturer: Minneapolis-Honeywell Regulator Company
Heiland Division
4800 East Dry Creek Road
Denver 10, Colorado
Tape Transport: Type 3168-4A1 (1 ea.)
Voltage: 117 volts 60 cycles

Tape Size: 1-inch tape
Tape Speed: 60, 30, 15, 7.5, 3.75, 1.875 ips
Reel Size: 10½ inches
Playback Head: IRIG standard playback head stack assembly
(two heads interleaved, 14 tracks per inch,
14 tracks total)
Speed Accuracy: Velocity within 0.25% of nominal at 30 and
60 cps
Velocity within $\pm 0.5\%$ of nominal at lower
speeds
Less than 0.25% change in tape speed from
beginning to end of reel any speed
FM Data Discriminators: Type 5206 (4 ea.)
Signal Input: Output of preamplifier on tape transport (0.5 mv to 500 mv)
Signal to Noise Ratio: Better than 60 db at the
carrier frequency
Better than 50 db throughout
entire duration range
Input Connection: Unbalanced
Signal Output Levels: 4 volts peak-to-peak at 75 ma for
 $\pm 40\%$ deviation
8 volts peak-to-peak at 30 ma for
 $\pm 40\%$ deviation
Voltage available is balanced or un-
balanced
Output Impedance (Internal): Less than 1 ohm
Output Recommended Load: Any load within the maximum
current and voltage range
Drift: Zero - $\pm 0.04\%$ per degree C. 0.1% under normal
laboratory conditions for an 8-hour period
Gain - $\pm 0.02\%$ per degree C., $\pm 0.1\%$ under normal
laboratory conditions for an 8-hour period
Linearity: The relationship between the input frequency
deviation and the output voltage is linear
within $\pm 0.5\%$ full scale for a deviation of $\pm 40\%$
Plug-In Center Frequency Assemblies: These assemblies determine
the nominal center fre-
quencies for the dis-
criminator. Low pass
filters provide 24
db/octave rolloff above
the frequencies of in-
terest, and are flat to
 $\pm \frac{1}{2}$ db within the passband.
FM Compensation Discriminator: Type 5256 (1 ea.)
Signal Input: Output of preamplifier on tape transport
(.5 mv to 500 mv)
Signal to Noise Ratio: Better than 50 db at any tape
speed
Input Connection: Balanced or unbalanced (either side may
be grounded)
Signal Output: Compensating error voltage to data dis-
criminator
Output Load: Will compensate up to 14 discriminators
Drift: At carrier frequency - $\pm 40\%$ per degree C. $\pm 0.1\%$
under normal laboratory conditions for an 8-hour
period

These two encoders determine and store in binary form the greatest positive value, occurring between successive positive-going zero crossings and the most negative value, occurring between successive negative-going zero crossings.

Accuracy	± 1 count, $\pm 1\%$
Response	0 to maximum in less than .0026 seconds

PEAK TO PEAK DETECTOR

The sum of counts corresponding to the readings in the positive and negative peak-encoders are read out into the level occurrence counters at successive positive-going and/or negative-going zero crossings. This is an 8-bit binary number.

ZERO CROSSING DETECTOR

Positive and negative-going zero crossings are extracted, and are used to operate the readout into the level occurrence counters and to reset the encoders.

LEVEL-OCCURRENCE COUNTERS

Number of Counters	16
Maximum Count	255 (8-bits)
Digital to Analog Conversion	10v. full scale, $\pm 1\%$ accuracy

The 16 counters will register a count when the encoded peak to peak values are: 1 to 11, 12 to 23, 24 to 35, 36 to 47, 48 to 59, 60 to 71, 72 to 83, 84 to 95, 96 to 107, 108 to 119, 120 to 131, 132 to 143, 144 to 155, 156 to 167, 168 to 179 and 180 to 255 respectively.

CONTROLS

Mode Switch	Peak to Peak Positive Peak Negative Peak (Trough) Positive and Negative Peak
-------------	---

Readout Gain

Counter Readout	10V. = full scale = 32, 64, 128, 256, 512, 1024, 2048, or 4096 counts
Auxiliary Readout	10V. = full scale = 128, 256, 512, 1024, 2048, or 4096 counts
Stop Mode	Overload of any level-occurrence counter or

one of the following: External command, predetermined time, predetermined number of cycles.

Readout Form Between thresholds, below thresholds.

Analysis Duration 2, 4, 6, 8, 12, 16, 24, 32, 48, 64, 96 seconds
(derived from 60 cps line.)
50, 100, 150, 200, 300, 400, 600, 800, 1200,
1600, 2400 counts into level occurrence counter.

AUXILIARY COMPUTATION

Moments Voltages proportional to total number of counts
and first and second moments are recorded.
10V. = 128, 256, 512, 1024, 2048, 4096 counts.

Greatest Peak to Peak Value Encodes and stores the greatest Peak to Peak
value during a given analysis cycle.

AUXILIARY CONTROLS

Relay Relay Closure to Turn Tape Recorder off and
Paper Recorder on at end of analysis cycle.
Turn Paper Recorder off and tape recorder on
after readout is completed.

Delay Incorporate selectable delay of 1, 2, 4
seconds $\pm 20\%$ after start of tape recorder and
before start of analysis cycle.

DESIGN

Approximate Size 30" x 19" x 13"

Approximate Weight 100 pounds

Temperature Range 50°F to 100°F

Power Required Approximately 70 watts, 115V. $\pm 10\%$ 60 cps
Panel mounted for installation in standard relay
rack.

APPENDIX C

SEA STATE NUMBERS CORRESPONDING TO BEAUFORT WIND SCALE

SEA STATE NUMBERS
CORRESPONDING TO BEAUFORT WIND SCALE

<u>Force</u>	<u>Wind Speed</u>	<u>Description of Sea</u>
0	Less than 1 kt	Like a mirror.
1	1-3 kt, mean 2 kt	Ripples, with the appearance of scales, are formed; but without foam crests.

2	4-6 kt, mean 5 kt	Small wavelets, still short but more pronounced - crests have a glassy appearance and do not break.
3	7-10 kt, mean 9 kt	Large wavelets. Crests begin to break. Foam of glassy appearance. Perhaps scattered white horses.
4	11-16 kt, mean 13 kt	Small waves becoming larger. Fairly frequent white horses.
5	17-21 kt, mean 18 kt	Moderate waves, taking a more pronounced long form; many white horses are formed. (Chance of some spray.)
6	22-27 kt, mean 24 kt	Large waves begin to form, the white foam crests are more extensive everywhere. (Probably some spray.)
7	23-33 kt, mean 30 kt	Sea heaps up and white foam from breaking waves begins to be blown in streaks along the direction of the wind.
8	34-40 kt, mean 37 kt	Moderately high waves of greater length, edges of crests begin to break into the spindrift. The foam is blown in well-marked streaks along the direction of the wind.
9	41-47 kt, mean 44 kt	High waves. Dense streaks of foam along the direction of the wind. Crests of waves begin to topple, tumble and roll over. Spray may affect visibility.
10	48-55 kt, mean 52 kt	Very high waves with long overhanging crests. The resulting foam in great patches is blown in dense white streaks along the direction of the wind. On the whole, the surface of the sea takes a white appearance. The tumbling of the sea becomes heavy and shock-like. Visibility affected.
11	56-63 kt, mean 60 kt	Exceptionally high waves. (Small and medium sized ships might be for a time lost to view behind the waves.) The sea is completely covered with long white patches of foam lying along the direction of the wind. Everywhere the edges of the wave crests are blown into path. Visibility affected.

<u>Force</u>	<u>Wind Speed</u>	<u>Description of Sea</u>
12	64-71 kt, mean 68 kt	The air is filled with foam and spray. Sea completely white with driving spray. Visibility very seriously affected.

Note: The Beaufort Scale extends to force 17 (118 kt.), but force 12 is the highest which can be distinguished visually from the sea.

SHIP HULL RESEARCH COMMITTEE

Division of Engineering & Industrial Research
National Academy of Sciences-National Research Council

Chairman:

RADM A. G. Mumma, USN (Ret.)
Vice President
Worthington Corporation

Members:

Mr. Hollinshead de Luce
Assistant to Vice President
Bethlehem Steel Co. Shipbuilding Div.

Professor J. Harvey Evans
Professor of Naval Architecture
Massachusetts Institute of Technology

Mr. M. G. Forrest
Vice President - Naval Architecture
Gibbs & Cox, Inc.

Mr. James Goodrich
General Manager
Todd Shipyards, Los Angeles Div.

Professor N. J. Hoff
Head, Dept. of Aeronautics & Astronautics
Stanford University

Mr. M. W. Lightner
Vice President, Applied Research
U. S. Steel Corporation

Dr. J. R. Low, Jr.
Metallurgy & Ceramics Research Dept.
General Electric Research Laboratory

Arthur R. Lytle
Director

R. W. Rumke
Executive Secretary