

AD 780 090

SSC-211

E-1123-1

TECHNICAL REPORT

TECHNICAL REPORT

E-1123-1

DESIGN AND INSTALLATION OF
A SHIP RESPONSE INSTRUMENTATION SYSTEM
ABOARD THE CONTAINER VESSEL
S.S. BOSTON

PROGRESS REPORT NO. 1

13 DECEMBER 1968



TELEDYNE MATERIALS RESEARCH COMPANY

A TELEDYNE COMPANY

DEPARTMENT OF THE NAVY
NAVAL SHIP SYSTEMS COMMAND
WASHINGTON, D. C. 20360

DESIGN AND INSTALLATION OF A
SHIP RESPONSE INSTRUMENTATION
SYSTEM ABOARD THE CONTAINER VESSEL
S.S. BOSTON

Progress Report No. 1

by

R. A. Fain, J. Q. Cragin
and B. H. Schofield

For the Period

1 July 1968 to 1 December 1968

TECHNICAL REPORT NO. E-1123-1

13 December 1968

CONTRACT N00024-68-C-5486
PROJECT SERIAL NO. F-35422306
TASK 2022, SR 182

TELEDYNE MATERIALS RESEARCH
303 BEAR HILL ROAD
WALTHAM, MASSACHUSETTS 02154

TABLE OF CONTENTS

| | Page |
|---|------|
| LIST OF FIGURES | i |
| LIST OF TABLES | .ii |
| LIST OF APPENDICES | iii |
| LIST OF ATTACHMENTS | iv |
| SUMMARY | v |
| ADMINISTRATIVE INFORMATION | .vi |
| | |
| 1.0 INTRODUCTION | 1 |
| 2.0 GENERAL | 3 |
| 3.0 TRANSDUCERS | 3 |
| 4.0 INSTRUMENT ROOM EQUIPMENT | 6 |
| 5.0 JUNCTION BOXES AND SHIP'S CABLING | 7 |
| 6.0 SYSTEM OPERATION | 7 |
| 7.0 ON-BOARD DATA ANALYSIS | 9 |
| 8.0 IN-HOUSE DATA REDUCTION | 9 |
| 9.0 S.S. BOSTON CALIBRATION | .10 |
| 10.0 CONCLUSIONS | .14 |

FIGURES 1 - 14

TABLES 1 - 4

APPENDICES A, B, C

ATTACHMENTS

DISTRIBUTION

DOCUMENT CONTROL DATA R & D (DD1473)

LIST OF FIGURES

- Figure 1 Container Vessel S. S. Boston
- Figure 2A Schematic View of Various Transducer Locations on S.S. BOSTON
- Figure 2B Sketch Showing Layout of Instrumentation Room and Scientist/
Observer Living Quarters on S.S. BOSTON
- Figure 3A Bridge Circuit - Vertical Longitudinal Bending
- Figure 3B Bridge Circuit - Horizontal Longitudinal Bending
- Figure 3C Bridge Circuit - Torsional Stress
- Figure 4 Sketch of Wave Height Measuring Buoy
- Figure 5 14 - Channel Shipboard Tape Recorder Ampex Model FR 1300
- Figure 6 Programmer Unit
- Figure 7 Data Analysis Tape Recorder Ampex Model 1260
- Figure 8 Dockside Calibration Conditions Using Double-Bottom Tanks
- Figure 9 Starboard Deck Gages 1 & 5, An Example of Poor Inside-Outside
Correlation
- Figure 10 Port Deck Gages 4 & 8, Typical Inside-Outside Correlation
- Figure 11 Port Shear Gages - Outside and Inside Front, Poor Inside-
Outside Correlation
- Figure 12 Heartof Plate Strains, Port Deck Gages
- Figure 13 Heart of Plate Strains, Starboard Deck Gages
- Figure 14 Heartof Plate Strains, Shear Gages

LIST OF TABLES

| | |
|---------|---|
| Table 1 | S.S. Boston Control Console Cabling |
| Table 2 | S.S. Boston Junction Box Specifications |
| Table 3 | S.S. Boston Shipboard Cabling |
| Table 4 | Characteristics of S.S. Boston |

LIST OF APPENDICES

- Appendix A Torsion Transducer Instrumentation
- Appendix B Transducer Specifications
- Appendix C Ampex FR-1300 Instrumentation Tape
Recorder Specifications

LIST OF ATTACHMENTS

| Drawing No. | Title | Sheets |
|-------------|---|--------|
| D2700 | Transducer Assembly | 1 |
| D2749 | Functional Block Diagram Recording System . . | 1 |
| D2750 | Functional Flow Diagrams | 6 |
| C2751 | Console Orientation | 3 |
| D2699A | Instrumentation Cabling S.S. BOSTON | 1 |

SUMMARY

Progress during this reporting period consisted of design, procurement, and installation of a ship response instrumentation system aboard the container vessel S.S. BOSTON. Included in this report are the following: a detailed description of the system, consisting of the parameters to be measured; the type and location of the transducers installed; components and functional operation of the data acquisition and recording system; data analysis procedures; and equipment specifications.

In addition, a description of the procedure and the results of the first transducer calibration attempt are presented.

Technical Report
No. E-1123-1

vi

ADMINISTRATIVE INFORMATION

The effort reported herein is being performed under Naval Ship Systems Command, Contract N00024-68-C-5486, Project Serial No. F-35422306, Task 2022, SR 182. Teledyne Materials Research internal project number is 1123/136. Contract control is by the Naval Ship Engineering Center, NAVSEC 6132, Department of the Navy, Washington, D. C. 20360. Mr. John Vasta is the Contract Administrator.

Teledyne Materials Research professional personnel performing this effort are Messrs. F. C. Bailey, B. H. Schofield, J. Q. Cragin, H. G. LaMontagne and R. A. Fain. The primary goal of this investigation is to obtain stress and motion data on this class of vessel and to supplement comparable investigations performed or now being performed on other types of vessels by the same sponsoring agency, i.e., Contract N00024-68-C-5231, Project Serial No. S-F013 0304, Task 2022, SR-153 and SR-172 Ship Response Statistics and Slamming Studies.

1.0 INTRODUCTION

The S.S. BOSTON represents a relatively new species of ocean-going vessel which emerged concomitantly with the novel container mode of cargo transportation. Of particular significance is the manifest departure in structural configuration of container ships from the conventional class of cargo ships; notably, the virtual lack of main deck support structure. Because of this structural anomaly, there is considerable interest in the effect such a change will produce in the behavioral characteristics of such vessels. The following sections describe the progress to date of the fabrication and installation of the instrumentation system designed to measure the stress and motion characteristics of the container vessel S.S. BOSTON.

The S.S. BOSTON, Figure 1, is owned and operated by Sea-Land Service Incorporated. Formerly this vessel was the S.S. GENERAL M.M. PATRICK, a C4-SA2 personnel carrier, and was subsequently converted to a C4-X2 container ship by Todd Shipyards Corporation, Galveston Division.

The basic design criteria for this system are twofold:

- 1.1 Create a semi-automatic data collection system to be used for manned voyages on the North Atlantic during the 1968-1969 season.
- 1.2 Provide data in a format compatible with the data collected from other instrumented vessels.

Design of the instrumentation system was initiated June 27, 1968. Installation of transducer components commenced in mid-July, 1968, at

Todd's Galveston Yard with final check out and initial data collection originally scheduled for the ship's first European voyage in late October, 1968.

Presumably because of shipyard construction priorities and urgency in the delivery of the vessel to the owner, a substantial portion of the instrumentation cabling, which was to be performed by the yard, was not completed. The vessel was immediately placed into service on a Newark, New Jersey-San Juan, Puerto Rico run. During the loading operations for this voyage a substantial portion of the Teledyne recording equipment was anchored in position in the instrument room. Teledyne engineers then accompanied the ship on one voyage with the intention of completing the shipyard cabling; however, time was not sufficient to finish the work. Subsequently, and upon a few hours' notice the vessel was rescheduled from the New Jersey-San Juan route to a European run. During this latter voyage an agreement was reached with Sea-Land for the completion of the shipyard cabling and final instrumentation wiring on the following European trip. On November 26, 1968, two TMR engineers boarded the vessel to undertake the cabling and place the instrumentation into operation.

At the present time all instrumentation, with the exception of the wave buoy system, is aboard the S.S. BOSTON and all wiring is completed with the exception of the midship transducers (accelerometer and pendulums). Because of the risk involved working the midship area while at sea, the latter will be connected during a port visit.

2.0 GENERAL

Both the recording and signal-conditioning equipment, assembled in a console unit, are located in an instrument room port side, upper deck, just forward of frame 195. Adjacent space has been modified to provide living quarters for personnel operating the equipment. Transducers are located at selected sites throughout the ship, Figure 2A. The location, type, and function of each are more fully discussed in the following sections. Semi-permanent cabling running from the vicinity of transducers to the instrument room via junction boxes provide the necessary interconnections. Figure 2B shows a layout plan of the personnel and equipment accommodations aboard the S.S. BOSTON.

3.0 TRANSDUCERS

The transducers in this system are divided into two categories. The first class consists of stress gages arranged in bridge circuits to provide the desired stress for a specific moment orientation relative to the ship, i.e., vertical or horizontal moment. Stress gages are located in housings (see Drawing D-2700) on both the top side and under deck surfaces of the main deck approximately 14-1/2" inboard of the side plate and 15 inches aft of frame 105. Gages in these housings are formed into two bridge circuits which provide outputs induced by vertical and horizontal longitudinal bending moments. See Figures 3A and 3B. The use of gages on both surfaces of the deck plate precludes a possible error due to plate unfairness in the gaging area. The bridge circuits also contain temperature compensation

gages to prevent thermal variations from biasing the data. In addition, each stress gage element is self-temperature compensating for steel applications.

Torsional shear gages are located in housings positioned on the in-board side of both the port and starboard side plate 20.3 feet above the keel line and 15 inches aft of frame 105. The gages themselves are 2-arm, 45 degrees from vertical, strain gages combined into a single 4-element bridge circuit in a configuration sensitive to torsional stress. A discussion of the torsion transducer installation is presented in Appendix A. See Appendix B and Figure 3C for further details of the torsion transducer.

Additional gages are located in the starboard and port tunnels to measure stresses at local areas. These units are not in housings but are single active gage elements with an associated temperature-compensating gage welded to the area of interest; the elements are then waterproofed and covered. These gages are read as half-bridges with bridge completion resistors located in the instrument room. Finally, two additional stress gages are located on the main deck, starboard side forward in the vicinity of #2 hatch coaming. These gages were incorporated into the data system in order to obtain a measure of the level of shear flow in the structure at the point where the open channel section of the hull terminates into the typical box beam section.

The second class of transducers are those located throughout the ship to provide information as to the structural or physical response of the vessel to the operational environment simultaneously with the measurement and recording of the structural stresses. These transducers provide vertical and horizontal (athwartship) acceleration at the bow, midships and stern, and pitch and roll angle midships. An equally significant portion of this class of transducers is the wave height buoy measuring system. This system consists of two basic items: 1) free floating wave buoys and, 2) a receiver-recorder system. The free floating buoys contain an accelerometer transducer and a radio transmitter unit with associated whip antenna. Figure 4 shows an outline sketch of such a buoy. As the buoy translates vertically with the waves, after launching from the ship, a signal is transmitted to the receiver unit aboard ship and recorded on magnetic tape. Subsequent analysis of these data provides an accurate measure of the wave height environment which is obtained for correlation with the data acquired from other transducers.

Two additional transducers are located in the tunnels; one port, one starboard, on the underdeck between frames 105 and 106. These devices measure longitudinal displacement of the deck over a 30-inch gage length to supplement the data obtained from the stress gages mounted in this vicinity.

A functional block diagram (Drawing D2749) is included to show the manner in which transducers are assembled to form a recording system.

The functional flow diagrams (Drawings D2750 SH1-SH6) included show the actual signal path from transducer to the instrument room and tape deck. Appendix B provides additional information as to the transducers used aboard this vessel.

4.0 INSTRUMENT ROOM EQUIPMENT

With the exception of the transducers, junction boxes and cabling, the remainder of the Teledyne Instrument System is located in the instrument room. Various units are packaged into a five-bay console unit which is the dominant feature of this room. Drawings D2751 SH1-SH3 included in this document, outline the various units found in the console. The equipment selected performs one of two functions i.e. it is directly involved in the excitation, conditioning or monitoring of transducer signals, or it is check out equipment used in the set-up, calibration and maintenance of the entire system. Additional portable instrumentation has been placed aboard the vessel to assist in system maintenance. Power to the console is supplied from the ship's hotel service in the form of four 20-ampere circuits of 115 V, 60 Hz from four circuit breakers in power panel C-TM1. This power is distributed throughout the console to various units. The console contains adequate protection of each active circuit as well as visual indications as to the status of each circuit (pilot lamps). (See SH3 Drawing D2751).

A key item in this system is the Ampex Model FR 1300, 14-channel FM tape recorder mounted on the right side of the console. (See Figure 5). A copy of the specifications of this unit is found in Appendix C.

The data channel assignment is as shown on the recording system block diagram, Drawing D2749. It is envisioned that most recording will be at a tape speed of 1-7/8 ips with its associated frequency response of 0 to 625 Hz. In the event that frequencies of higher magnitude are deemed of interest, the recording speed can be increased proportionally.

The various panels and units within the console are connected via a series of cables. Table 1 summarizes the characteristics and functions of these cables and presents an insight into the complexity of the system.

5.0 JUNCTION BOXES AND SHIP'S CABLING

The locations of junction boxes and their associated cabling are shown on Drawing D2699A. A comprehensive listing of junction boxes is provided in Table 2 and descriptive information on the cabling in Table 3.

6.0 SYSTEM OPERATION

The system, as previously stated, is semi-automatic in design. The variety of mode operations is controlled by the programmer unit shown in Figure 6. In the automatic mode the system is turned on for a specified interval at preset hours. Initial settings have been selected for an interval of 15 minutes every four hours with the tape recorder set to run at 1-7/8 ips. During this 15-minute interval three data periods are recorded. Each data period presently consists of 15 seconds of zero; i.e., open-circuiting of transducer signal lines and removal of excitation from bridge circuits; one minute of calibration, i.e., shunting of one arm of the bridge circuits with a specified resistance, or, in the case of the

accelerometers, substitution of a calibration voltage; and a period of 3 minutes 45 seconds of data collection. During the 60 seconds of calibration the bridge-shunting resistance is cycled on and off approximately 10 times to create a series of calibration spikes which are used to trigger in-house data analysis equipment. All of the times selected are variable with the operator having complete flexibility of time settings.

In addition, upon the occurrence of a signal (from a selected bridge circuit) higher than a preset stress level, the system generates an alarm and automatically goes into a recording sequence. The length of this sequence is again controllable and is presently set for 15 minutes. At the end of this period the equipment is reset; in the event the high stress condition still exists, a repeat cycle is immediately initiated.

At any time, the operator can switch the system to manual and go into a continuous recording mode. Even in this manual mode, the zero-calibration sequence is performed at the set interval so that all data will be compatible in format.

The system starts and stops the tape recorder as required and keeps track of total time recorded.

The wave monitoring system is a separate integral unit and contains its own 2-track audio tape recorder. This system is placed into operation when a wave buoy is launched from the vessel. The transmitted information is recorded as long as signal strength permits; in the order of 30 to 40 minutes. It is planned to launch four buoys during this winter season when the sea conditions are Beaufort State 6 or above.

In addition to data recorded on the two tape recorders, log book readings, recorded once each watch, will provide information as to ship's position and speed, the relative wind direction and speed and the conditions of the sea at that time.

7.0 ON-BOARD DATA ANALYSIS

During non-recording intervals aboard the vessel it is planned to have the operator perform "quick look" data analysis. This analysis involves placing the recorder in a play-back mode and playing the data into an oscillograph to create chart paper data traces. Up to six data channels at a time can be presented in this manner. The operator, by analyzing these traces, can determine the condition of each of his data channels. Changes in gain, calibration or general maintenance can then be accomplished to ensure that the system is in top running condition.

In addition, a time correlation with log book data will be performed to ensure that trace response is compatible with wind and sea conditions.

8.0 IN-HOUSE DATA REDUCTION

Since it will be possible to acquire data on a selective basis, and since the items of primary interest in this instance are maximum values and the relation of ship and container data, it is expected that the bulk of the analysis can be performed by the engineer aboard ship, who will be equipped with oscillograph playback equipment. However, if required, the probability analyzer is available in the laboratory to permit rapid searches for maximum values and for developing certain other statistical parameters of the data. At the conclusion of each voyage, the tapes and log books will be returned to Teledyne Materials Research at Waltham, Massachusetts. The tapes will be

re-run on a compatible Ampex Model 1260 Tape Recorder (see Figure 7). The processed information is placed on a punched card suitable for computer input. In addition, ship, wind, and sea information for each data period is also punched on the card. Thus, when a reel of tape has been processed, one punched card contains the information from each data period. These cards are fed into an in-house IBM Computer. The computer printout contains the values of peak-to-peak and RMS stress levels for each stress channel corresponding to the various sea states.

The wave buoy tapes will be analyzed by a computer program in order to produce wave spectra information for correlation with the stress data.

9.0 S.S. BOSTON CALIBRATION

Strain gage data were recorded from the partly completed instrumentation systems on the S.S. BOSTON during the period from August 8 to 29, 1968, for the purpose of obtaining a physical calibration of the system. Strain data acquired while statically bending the ship with known loads permits a comparison with computer calculations of the structure's behavior. Specifically, the calibration was required not only to provide verification of the integrity of the measuring system in comparison to

computed values, but to evaluate the effectiveness of strain gages on one side of a shell plate in presenting heart-of-plate data. Figure 8 shows the calibration conditions used. Conditions shown in b, e, and h were selected for the computer analysis.

Vessel calibrations are carried out, whenever possible, on calm, cloudy nights in order to minimize the effects of differential thermal distributions. Since the load conditions on the S.S. BOSTON were to be varied at a very slow rate, the calibration had to be undertaken over a 21-day period while ballast mud was being placed in the double-bottom spaces of the vessel. In an attempt to improve the possibility of salvaging meaningful data under these conditions, stress measurements were taken at frequent intervals in the hope that thermal effects could be separated from stress changes resulting from the known loads. As will be noted in the following discussions, this was not possible probably because of the numerous other factors involved, such as changes in vessel position and continued addition of structural material during the calibration.

Although some meaningful data were acquired, it is felt that the system should be recalibrated under more tightly controlled and optimized conditions. This recalibration should be performed with known weight containers and ideally performed in an overnight period to minimize thermal problems.

The strain gages themselves are matched to the coefficient of expansion of the structure but the vessel still sees "real" strains imposed by differential heating of the vessel. In many cases in the August period, the thermally-induced strains were higher than the ballast load-induced strains.

It is also recommended that proper stiffnesses, weights and locations be used. An independent naval architect familiar with torsion of ships with large deck openings should review the analysis for adequacy.

The current Designers & Planners' data are superimposed on the heart-of-plate experimental strain data in Figures 12, 13 and 14. Agreement with this quite fundamental analysis is unacceptable, as well as some unexplainable scatter within the sets of gages at any particular location that should all sense the same strain magnitude.

The Designers & Planners' calculated starboard deck data are compression in sense due to the large contribution of what they term "deck stress due to torsion." This value is added to port and subtracted from starboard deck stress, greatly influencing, somewhat questionably, the value and sign of the deck stress.

A recalibration of the system should be performed for the following reasons:

1. Too many extreme thermal cycles in the August period tend to mask the load-induced strain data.
2. Wiring of the system is now completed; thus the problems with temporary cabling will not be repeated.
3. All future data generated by the system will be based upon the results of a good calibration.

This vessel recalibration and predicted stress correlation should have the following ground rules:

Typical of any transducer application of strain gages, exercise of the system improves its performance. A study of the back-to-back gages on the S.S. BOSTON shows that the inside to outside error is gradually reduced to essentially one value after as few as three cycles of thermal and/or physical strain. The final difference is approximately $5\mu\epsilon$, equal to the minor scale division on the readout equipment. See Figures 9, 10, and 11.

Because of shipyard production problems, internal cabling of the vessel was not finalized at calibration time, so port and starboard data were acquired as one-half bridge rather than the desired full bridge configuration. As one-half bridges, the torsion transducers bonded to the side shell are sensitive to both vertical shear and torsion of the vessel. Ordinarily, these would be separable, but here, with the unknown thermal effects superimposed, it is impossible to obtain explicit values for all the contributing factors.

Designers and Planners, Inc. of New York were asked by Sea-Land to use their computer facilities to predict stresses in the gaged locations for correlation with the experimental data. An existing bending program was used without modification for the state-of-flux structural condition of the vessel. Ballast load inputs used were not from the S.S. BOSTON, but from a non-identical sister ship, the NEWARK.

It is recommended that a combined torsion and bending program be used by Designers & Planners to predict more closely calibration loading stresses.

1. Calibrate overnight during a period of reasonably constant temperature.
2. Use containers with known loads, located at known distances from the midship datum.
3. Modify the Designers & Planners' computer program to include torsion and have the technique approved by a structural specialist.
4. Most important is to accept the fact that a quality calibration is of prime value, and have no other major shipboard activity progressing during the calibration period.

10.0 CONCLUSIONS

At the present time the instrumentation system has been installed aboard the S.S. BOSTON, wired, checked out and is expected to be in operation collecting data on the run from Europe beginning December 9. The only exception to completion is the final wiring of the midship accelerometers and pendulum devices as noted in the body of this report.

It is anticipated that during the next report period the midship transducers will be placed into operation, and that data analysis will be underway contemporaneously with the collection of additional data aboard the S.S. BOSTON.

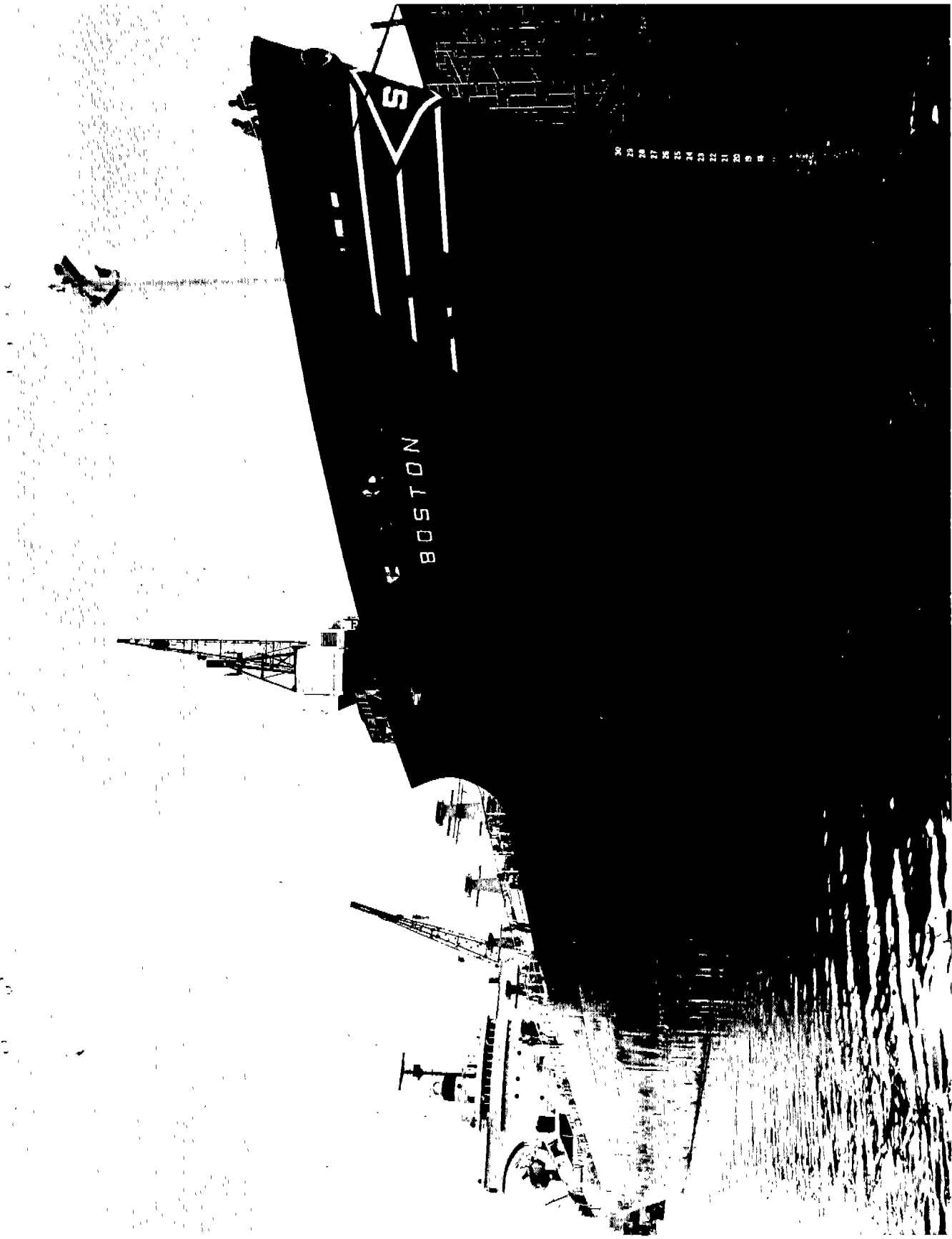
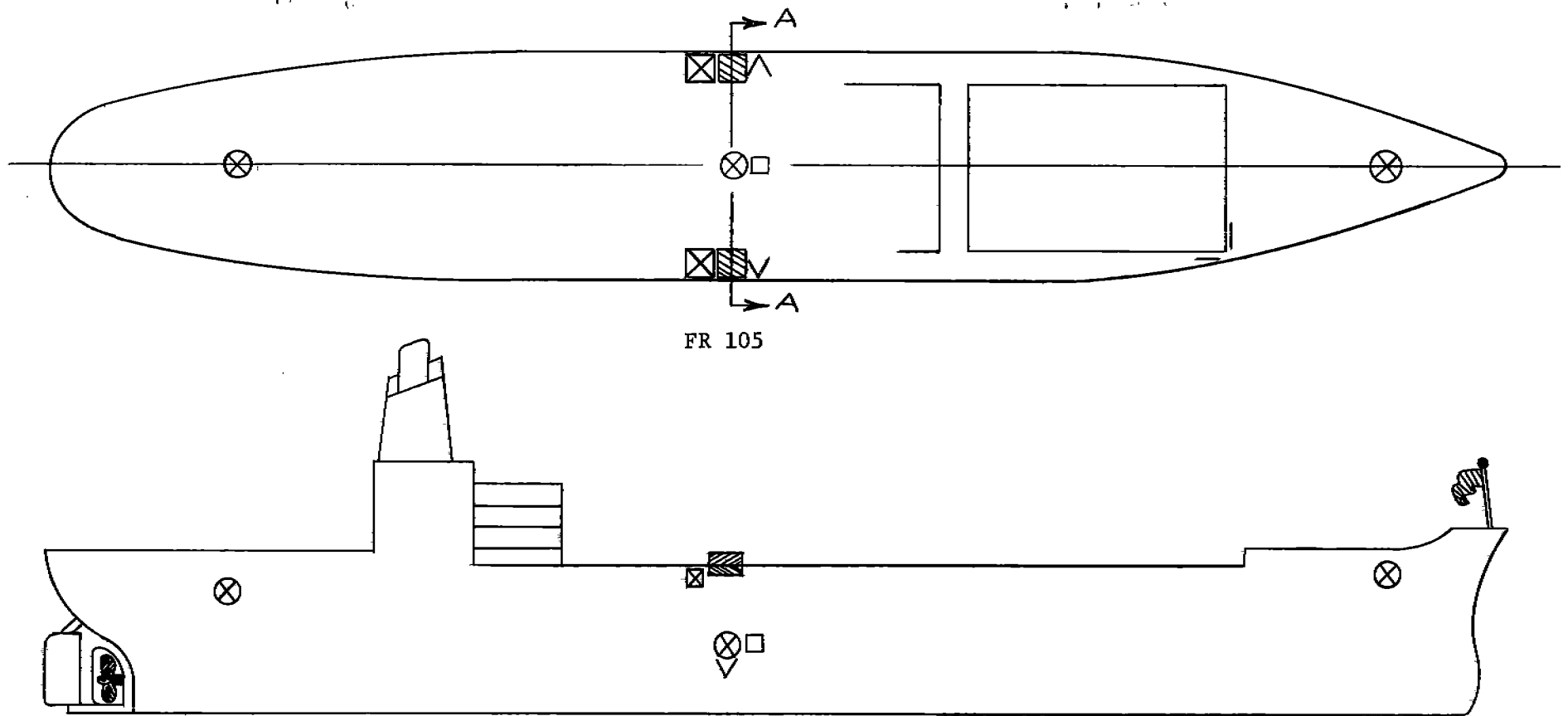

FIGURE 1. CONTAINER VESSEL S.S. BOSTON



FR 105

- ⊗ Bi-directional accelerometer (horizontal-vertical)
- Pendulum transducers for pitch and roll
- ▨ Stress gage transducer
- ⊠ 30-inch gage length displacement transducer
- ∇ Torsional strain gage bridge
- | Single element stress gages, longitudinal orientation

Section AA

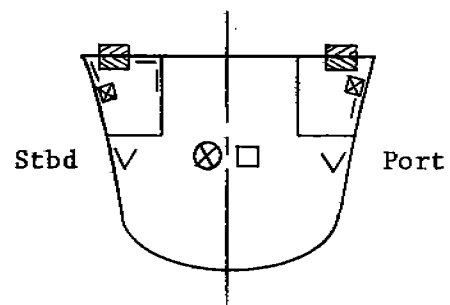

Transducers at Midship Section
Including Box Beam Gages

FIGURE 2A. SCHEMATIC VIEW OF VARIOUS TRANSDUCER
LOCATIONS ON SS BOSTON

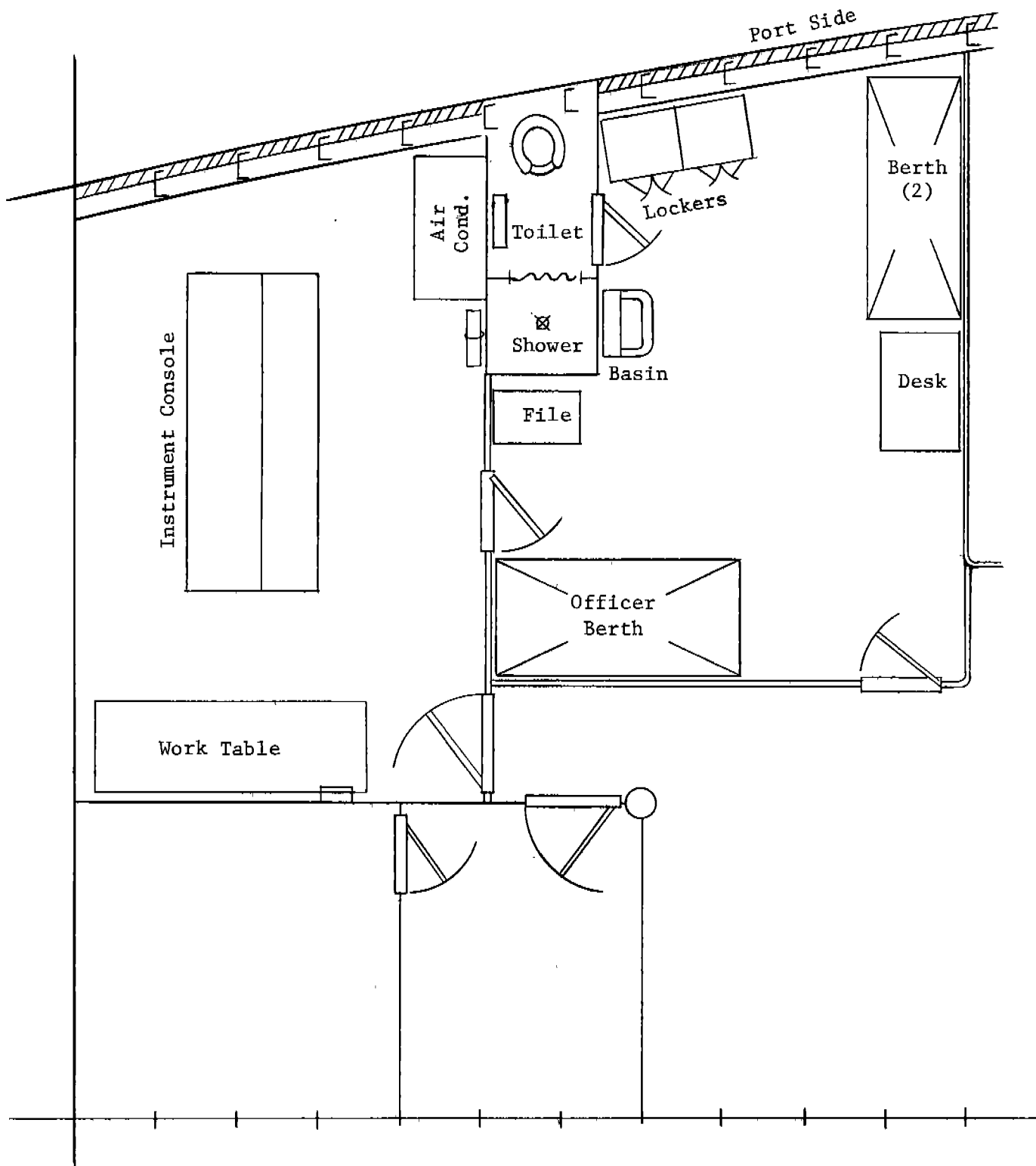
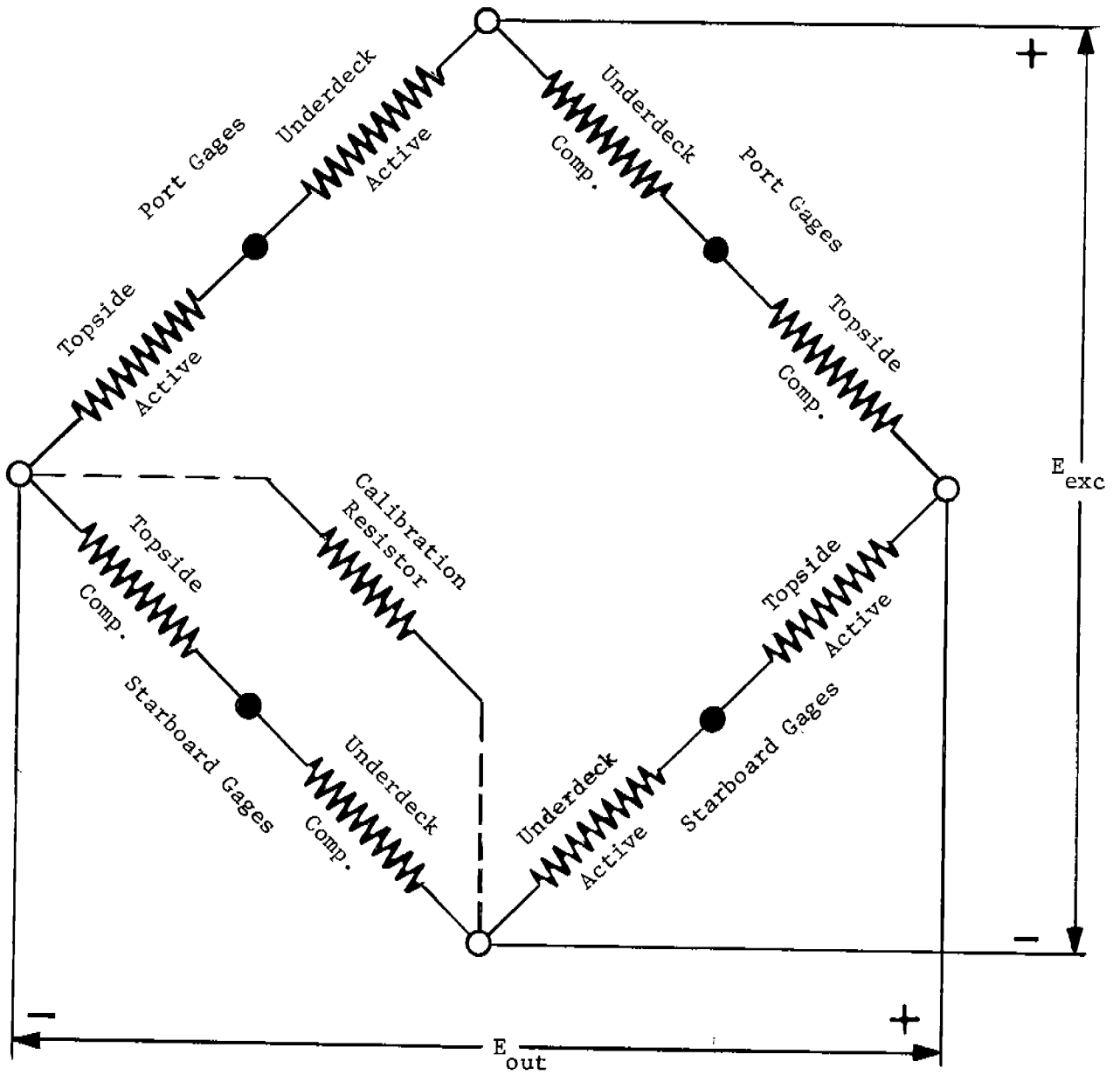
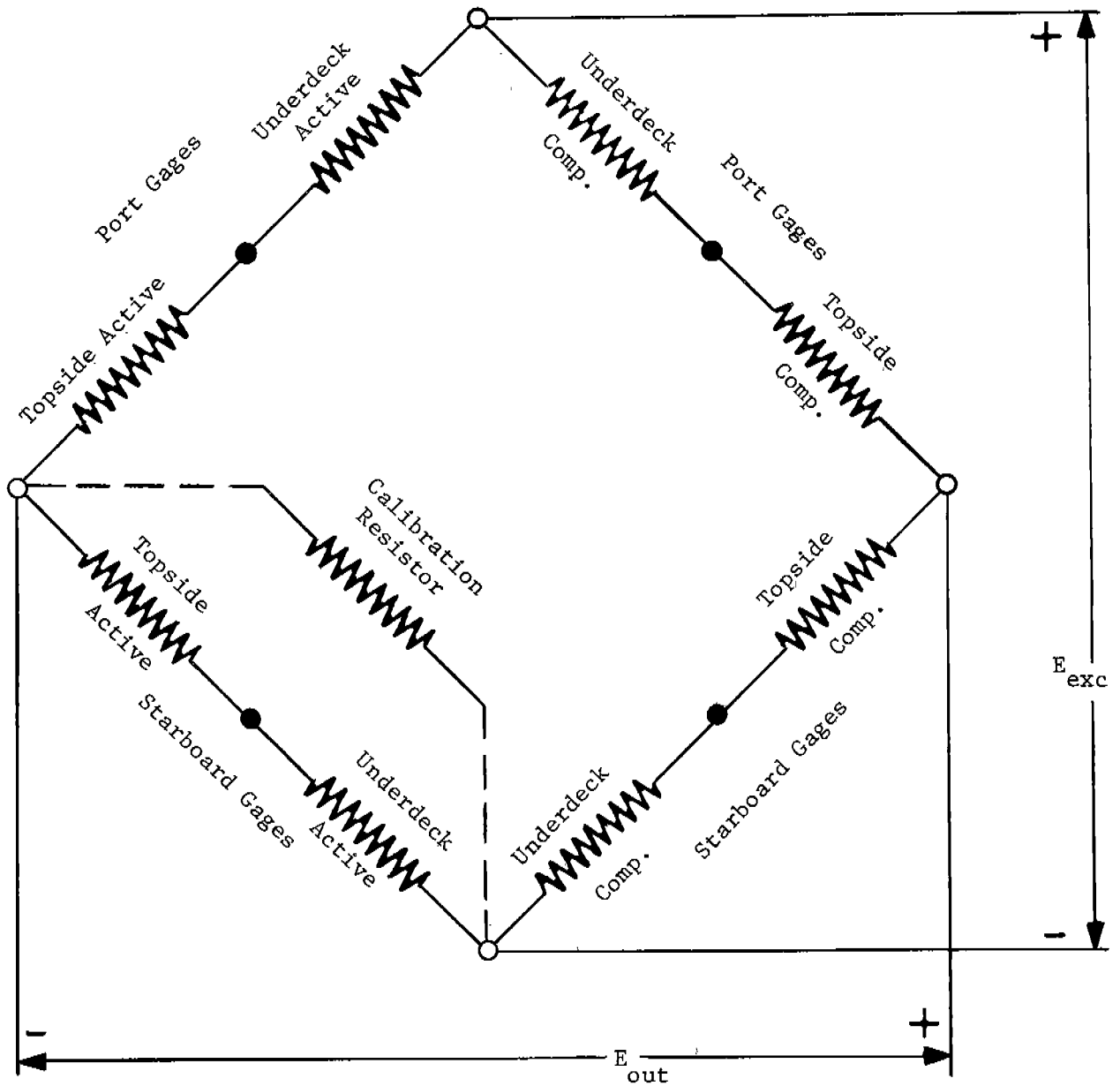

FIGURE 2B. SKETCH SHOWING LAYOUT OF INSTRUMENTATION ROOM AND SCIENTIST/OBSERVER LIVING QUARTERS ON SS BOSTON



Note: All Bridge Elements are 448 ohm Stress Gages

FIGURE 3A. BRIDGE CIRCUIT - VERTICAL LONGITUDINAL BENDING



Note: All Bridge Elements are 448 ohm Stress Gages

FIGURE 3B. BRIDGE CIRCUIT-HORIZONTAL LONGITUDINAL BENDING

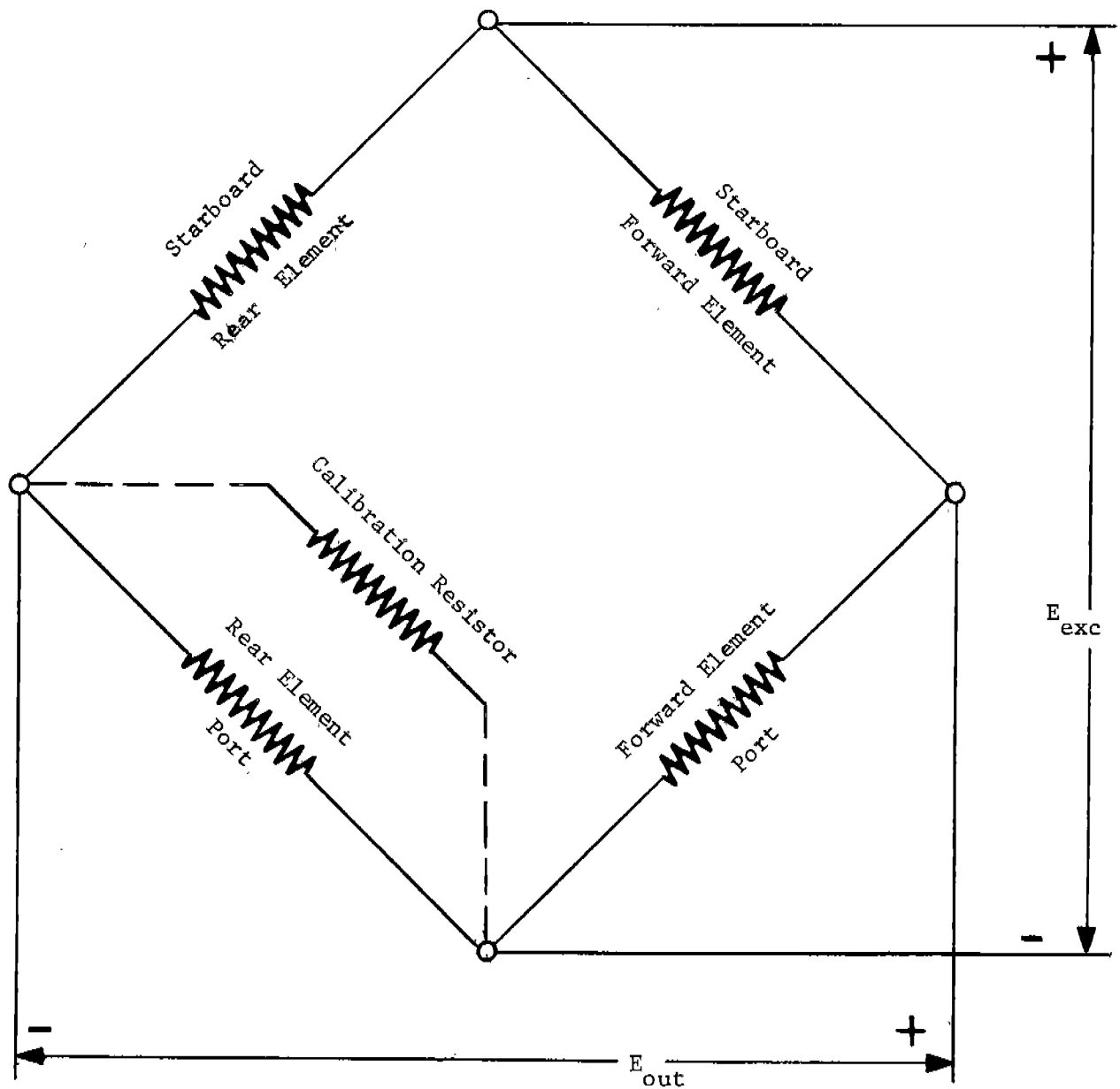

Note: Gages at both locations are two-arm strain gages, each arm 120 ohms set at 45° to the local vertical

FIGURE 3C. BRIDGE CIRCUIT-TORSIONAL STRESS

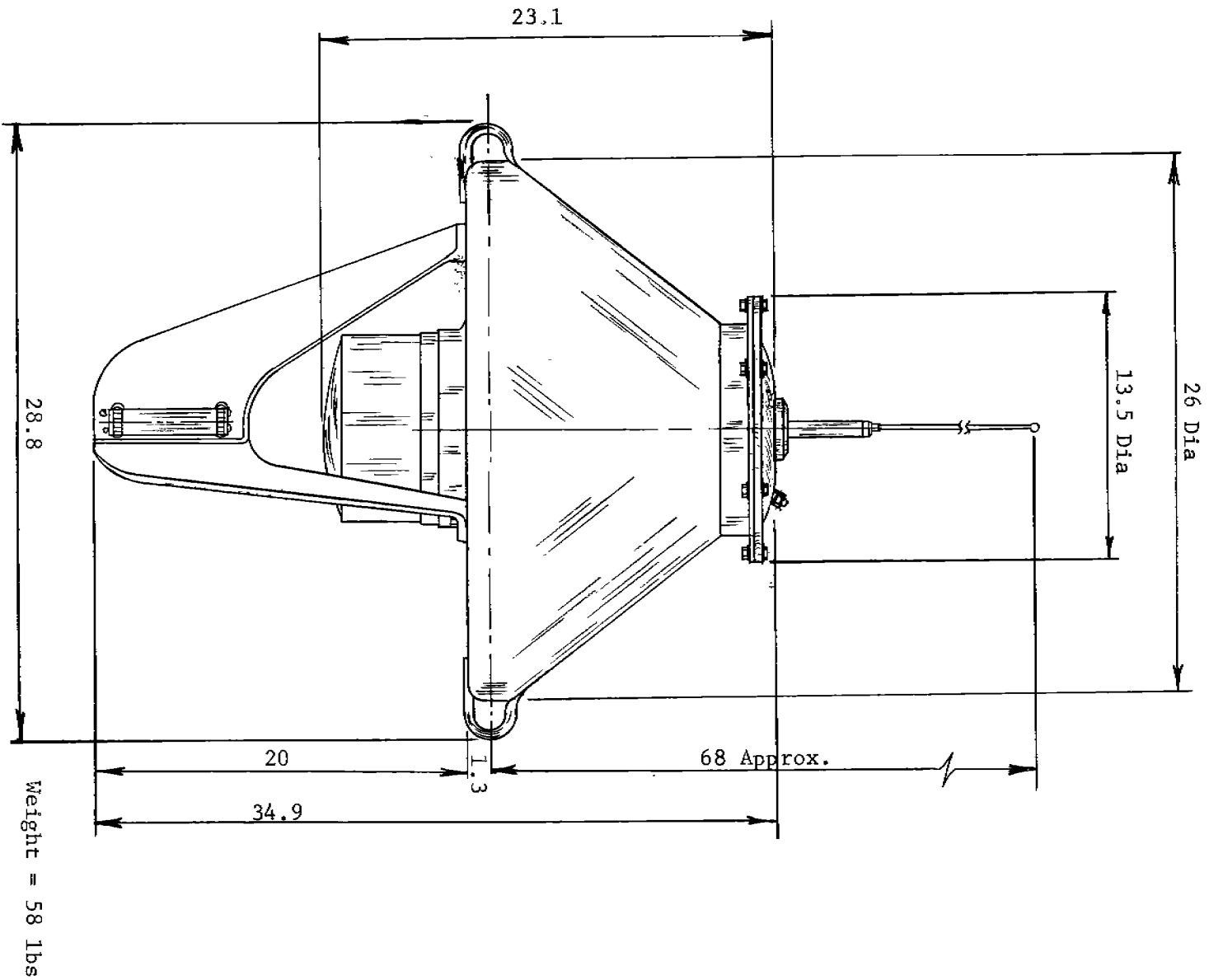
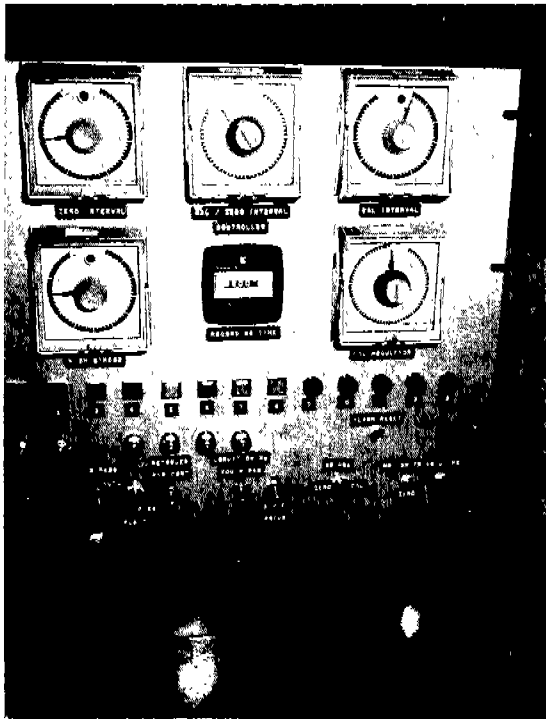

FIGURE 4. SKETCH OF WAVE HEIGHT MEASURING BUOY



FIGURE 5. 14-CHANNEL SHIPBOARD TAPE RECORDER
AMPEX MODEL FR 1300



(a) Front Panel of Unit

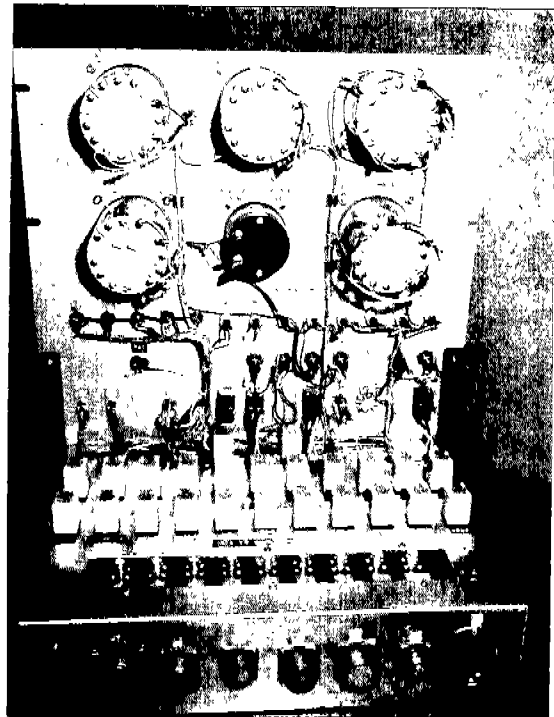

(b) Rear View of Unit

FIGURE 6. PROGRAMMER UNIT

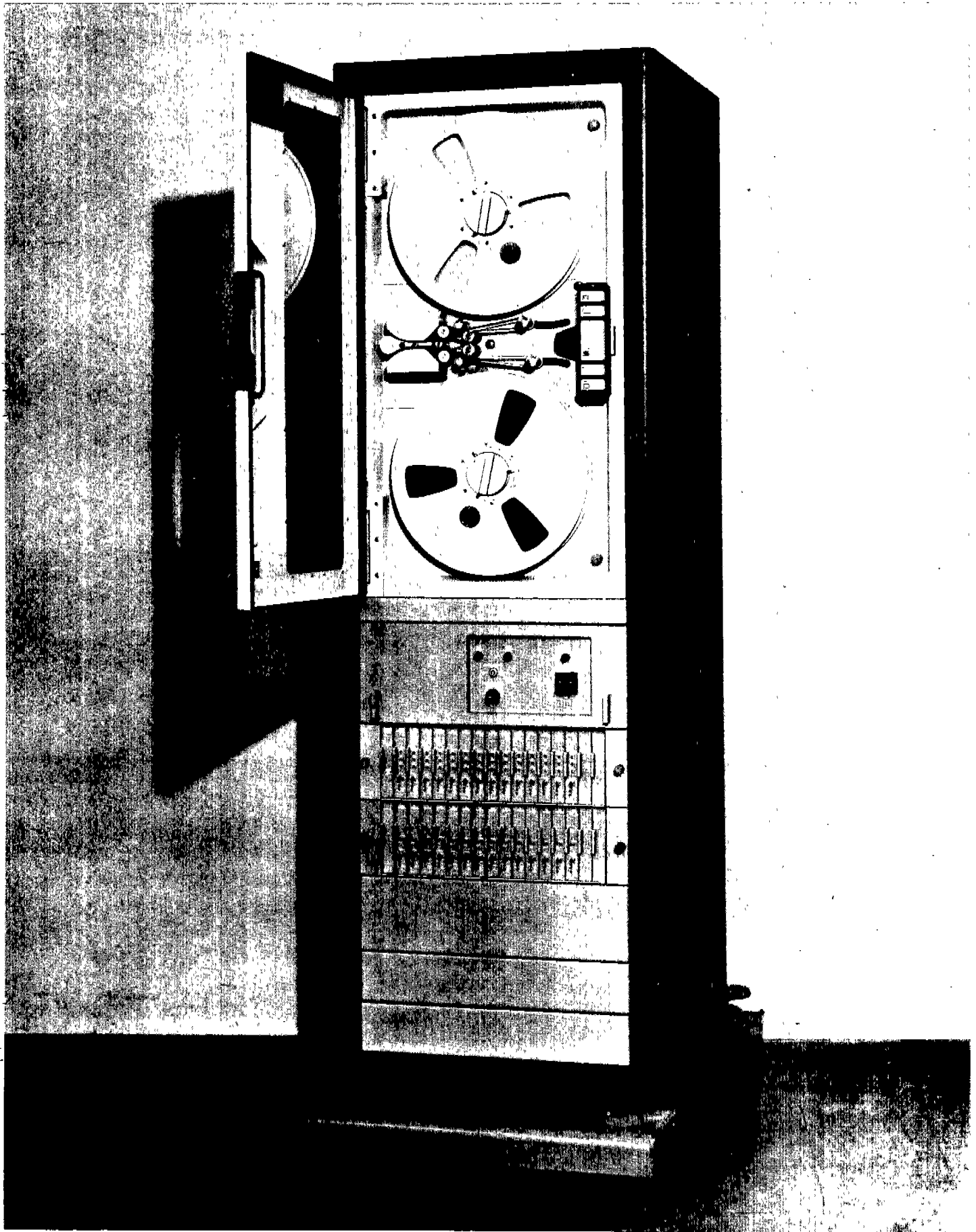

FIGURE 7. DATA ANALYSIS TAPE RECORDER
AMPEX MODEL 1260

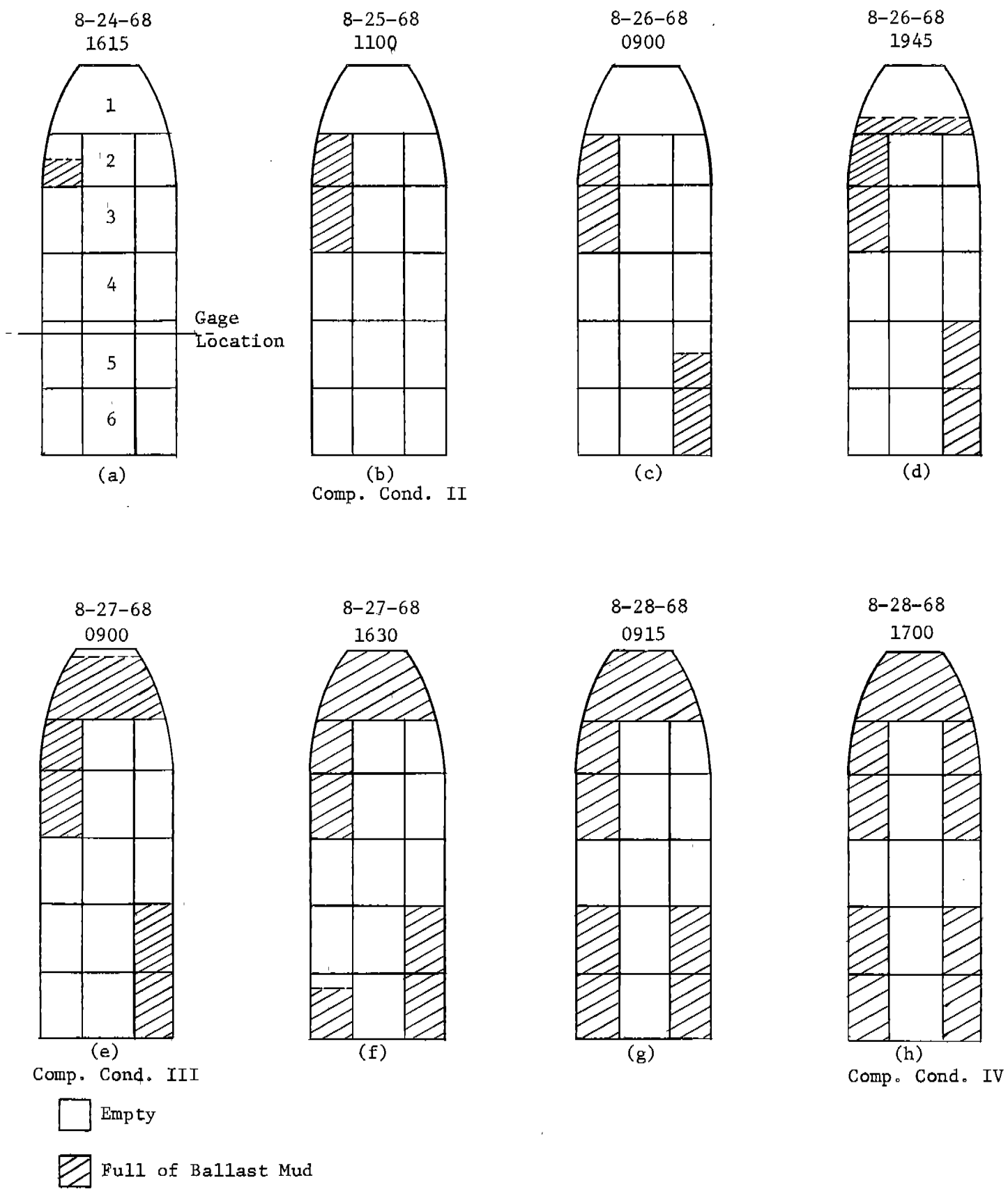

FIGURE 8
 Dockside Calibration Conditions
 Using Double-Bottom Tanks

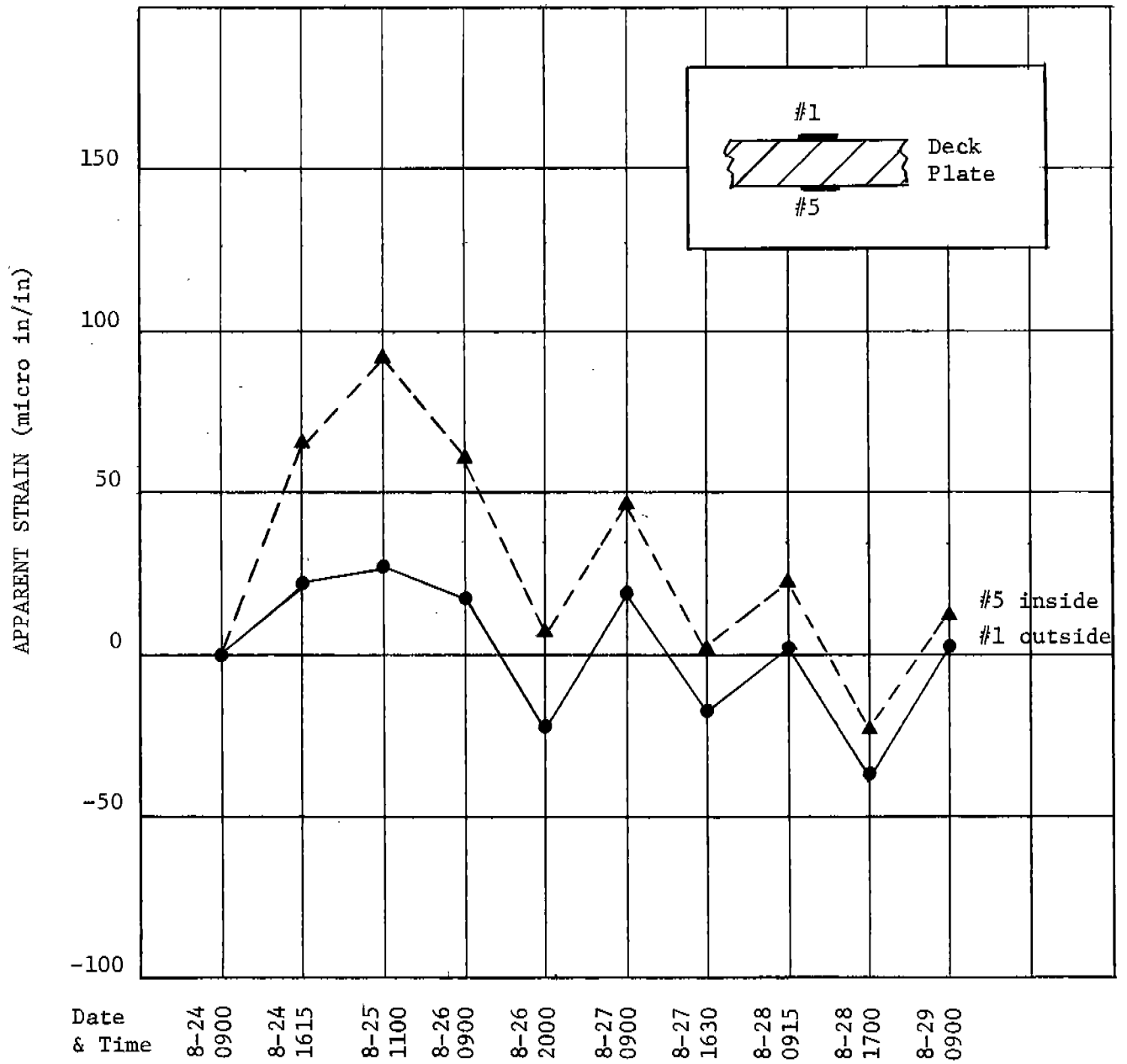

FIGURE 9

Starboard Deck Gages 1 & 5
An Example of Poor Inside-Outside Correlation

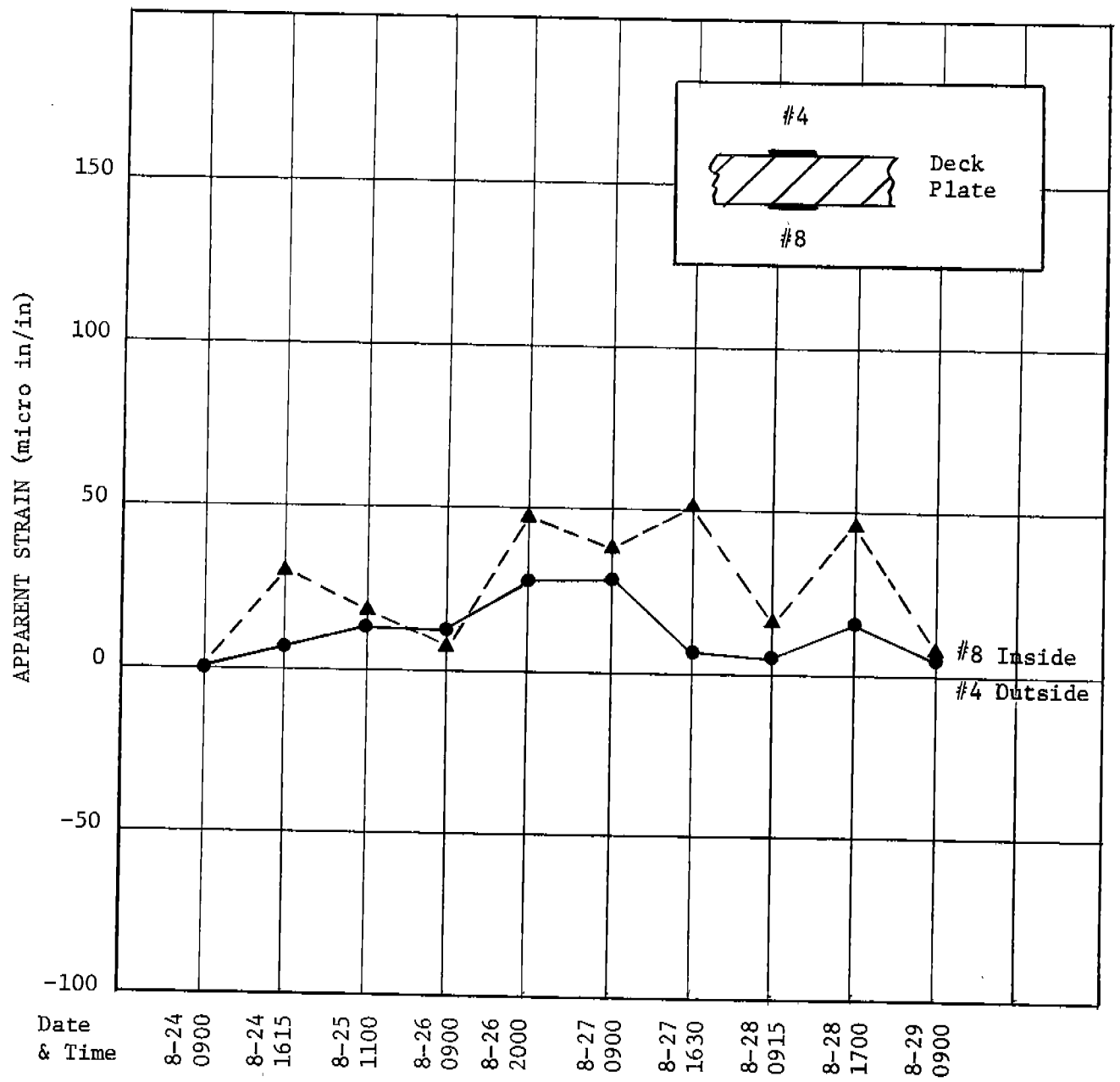

FIGURE 10

Port Deck Gages 4 & 8
 Typical Inside-Outside Correlation

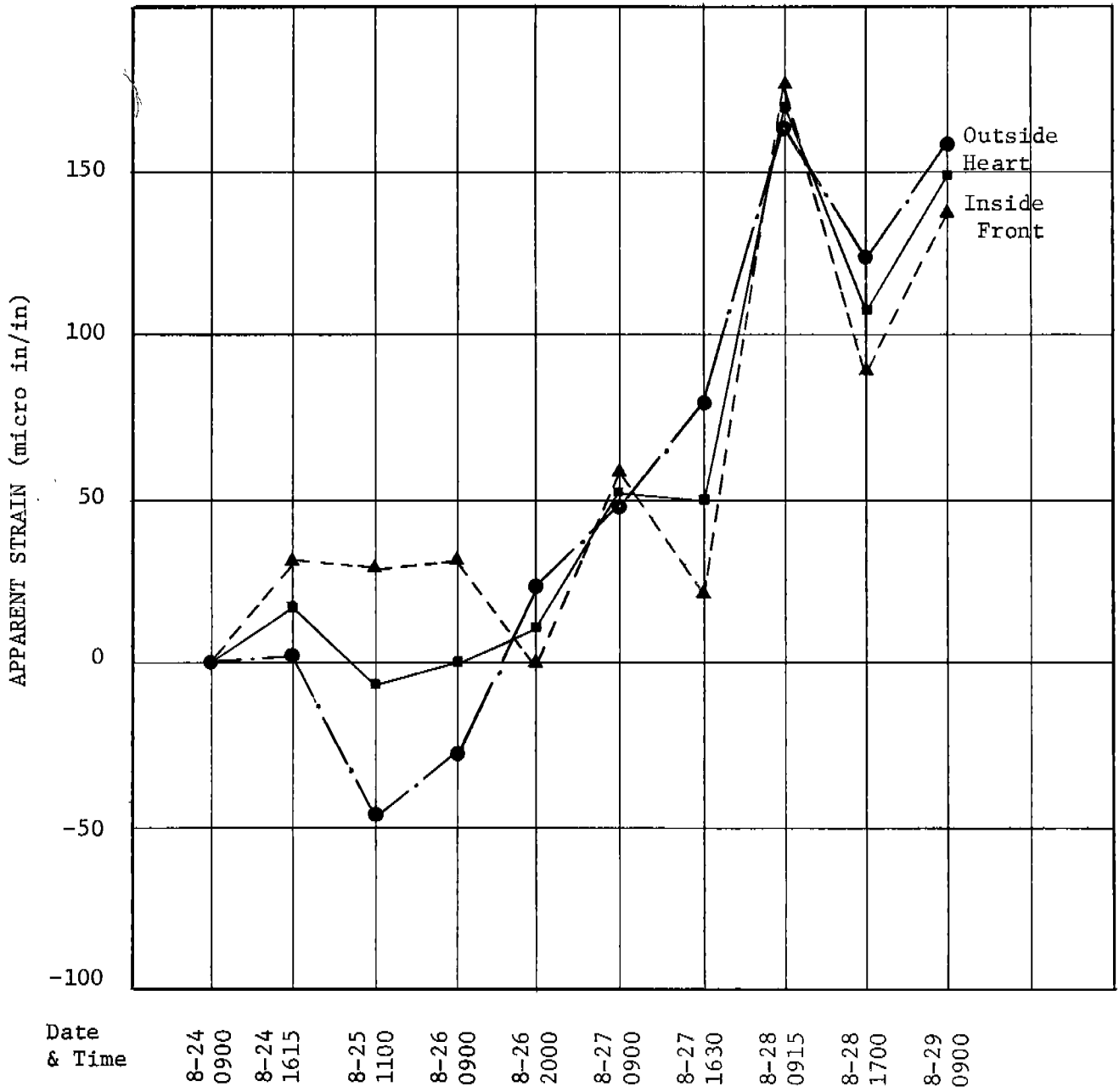

FIGURE 11
 Port Shear Gages-Outside & Inside Front
 Poor Inside-Outside Correlation

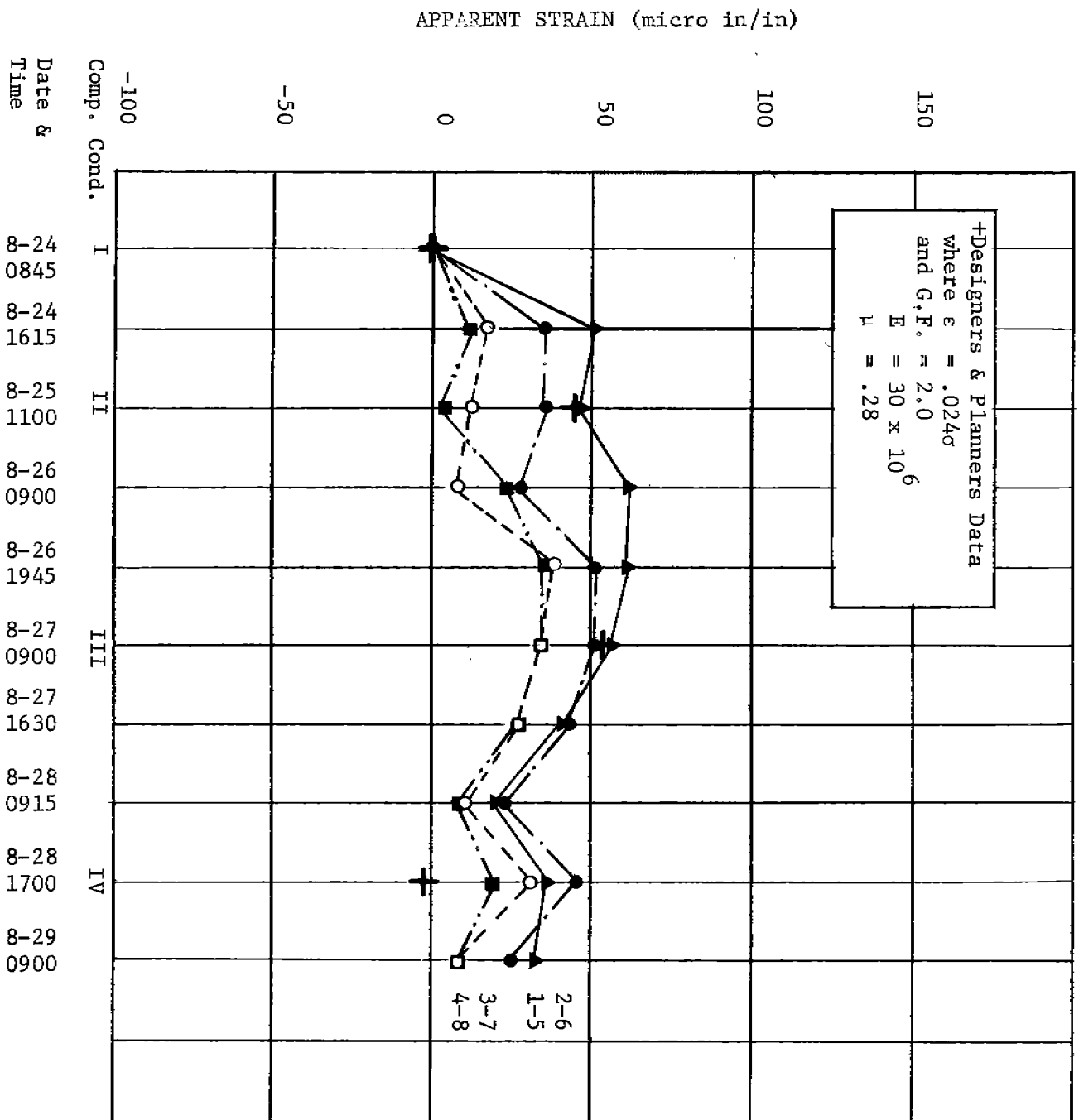

FIGURE 12
 Heart of Plate Strains
 Port Deck Gages

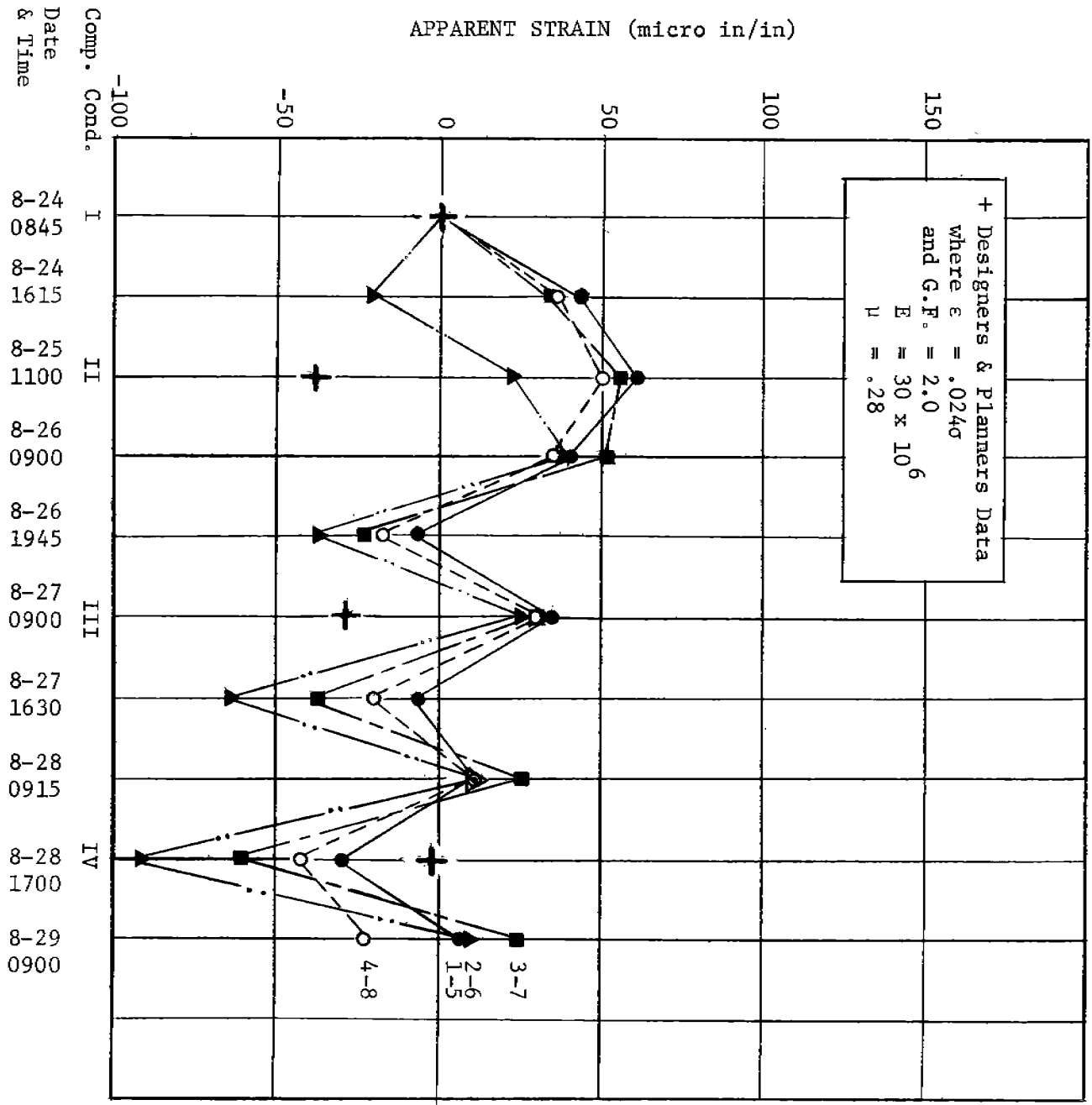

FIGURE 13
 Heart of Plate Strains
 Starboard Deck Gages

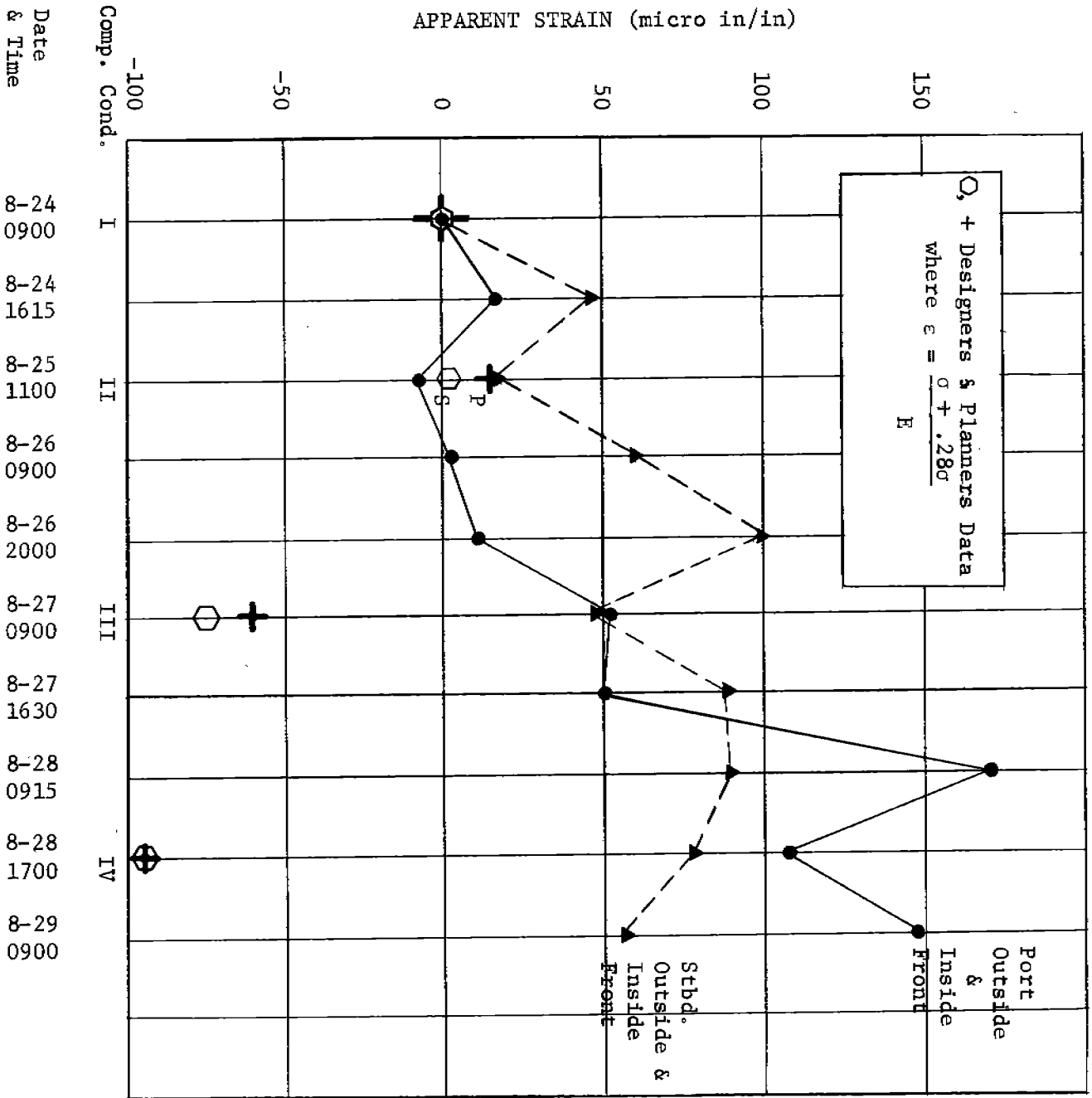

FIGURE 14
Heart of Plate Strains
Shear Gages

TABLE NO. 1

S.S. BOSTON CONTROL CONSOLE CABLING

| Console Cable No. | From | To | Size/Function | Cable Type |
|---|----------------------------|--|---|------------------|
| 1 | 24-Hr. Timer | Programmer | 4 Cond. AWG #20 Timing Signals | Belden 8424 |
| 2 | Programmer | Stress Monitoring Panel | 8 Cond. AWG #20 Stress Signals | Belden 8418 |
| 3 | Programmer | Tape Recorder | 6 Cond. AWG #20 Control Signals | Belden 8426 |
| 4 | Programmer | Signal Conditioning Equipment | 6 Cond. AWG #20 Control Signals | Belden 8426 |
| 5 | Power Supply #8 | Programmer | 4 Cond. AWG #20 DC Power | Belden 8424 |
| 6 | Junction Box C-TM12 | Programmer | 20 Cond. AWG #20 Transducer Signals | MSV-20 |
| 7 | Programmer | Junction Box C-TM 12 | 12 Cond. AWG #20 Calibration Com- mands | Alpha 1255/12 |
| 8 4 Req'd. 8.1, 8.2, 8.3, 8.4. | S.C. Xducer Output Jack | S.C. Amp. Input | 2 Cond. AWG #20 Bridge Signals | Belden 8412 |
| 9 4 Req'd. 9.1, 9.2 9.3, 9.4. | S.C. Amp. Output Jack | Stress Monitoring Panel | 2 Cond. AWG #20 Bridge Signals | Belden 8412 |
| 10 | S.C. Monitoring Jack | Stress Monitoring Panel | 2 Cond. AWG #20 Excitation Voltage | Belden 8412 |
| 11.1 11.2 11.3 | Junction Box GTM11A&B | S.C. Equip. Xducer Input CH1, CH2, CH3. | 8 Cond. AWG #20 Bridge Signals | Belden 8418 |

TABLE NO. 1

S.S. BOSTON CONTROL CONSOLE CABLING

(Continued)

| Console Cable No. | From | To | Size/Function | Cable Type |
|-------------------|----------------------------------|--------------------------------|---------------------------------------|---------------|
| 11.4 | Conditioning Channel Select Pane | S.C. Equip. Xducer Input CH. 4 | 8 Cond. AWG #20 Bridge Signals | Belden 8418 |
| 12 | J.B. C-TM11B | Conditioning CH. Select Panel | 6 Cond. AWG #20 Port Tunnel Signals | Belden 8426 |
| 13 | J.B. C-TM11A | Conditioning CH. Select Panel | 20 Cond. AWG #20 Stbd. Tunnel Signals | MSV-20 |
| 14 | J.B. C-TM10 | Conditioning CH. Select Panel | 12 Cond. AWG #20 Bow Coaming Signals | Alpha 1255/12 |
| 15 | Oscillograph Play-Back Panel | Oscillo-graph | 12 Cond. AWG #20 Play-Back Signals | Alpha 1255/12 |
| 16 | Junction Boxes C-TM11A & B | Displacement Transducer Panel | 4 Cond. AWG #20 Displacement Signals | Belden 8424 |
| 17 | Power Supply #7 | J.B. C-TM12 | 4 Cond. AWG #20 DC Power | Belden 8424 |
| 18 | Power Supplies #1 to #4 | J.B. C-TM12 | 20 Cond. AWG #20 DC Power | MSV-20 |
| 19 | Power Supplies #5 & #6 | J.B. C-TM11A & B | 8 Cond. AWG #20 DC Power | Alpha 1255/8 |
| 20 2 Req'd. | Power Panel C-TM1 | Console Power | 4 Cond. AWG #10 AC Power | Types |

NOTE: All cables are overall shielded with rubber or vinyl jacket.

TABLE NO. 2

S.S. BOSTON JUNCTION BOX SPECIFICATIONS

| Junction Box Number | No. of Terminals | Physical Location |
|---------------------|-------------------------------------|-----------------------|
| C-TM1 | 40 | Stbd. Side FR 129 |
| C-TM2 | 40 | Stbd. Side FR 97 |
| C-TM3 | 40 | Stbd. Side FR 65 |
| C-TM4 | 40 | Stbd. Side FR 47 |
| C-TM5 | 40 | Amidships FR 13 |
| C-TM6 | 40 | Amidships FR 195 |
| C-TM7 | 40 | Amidships FR 112 |
| C-TM8 } C-TM9 } | Deleted Due to New Cable Routing | |
| C-TM10 | 40 | Aft Bulkhead TMR Room |
| C-TM11A | 80 | Aft Bulkhead TMR Room |
| C-TM11B | 80 | Aft Bulkhead TMR Room |
| C-TM12 | 80 | Aft Bulkhead TMR Room |
| C-TM13 | 10 | Aft Bulkhead TMR Room |
| C-TM14 | 80 | Port Tunnel FR 105 |
| C-TM15 | 80 | Stbd. Tunnel FR 105 |
| C-TM16 | 10 | Bridge Deck |

NOTE: Power Panel CTM-1 is in Instrument Room.

TABLE NO. 3

S.S. BOSTON SHIPBOARD CABLING

| Cable No. | From Junction Box | To Junction Box | Size/Function | Cable Type |
|----------------------|---------------------------------|-----------------|---|------------|
| C-TM1 | C-TM10 | C-TM1 | 10 AWG #18 Power Containers | MSV-10 |
| C-TM2 | C-TM10 | C-TM1 | 20 AWG #20 Container Measure- ments | MSV-20 |
| C-TM3 | C-TM1 | C-TM2 | 10 AWG #18 Power Containers | MSV-10 |
| C-TM4 | C-TM1 | C-TM2 | 20 AWG #20 Container Measure- ments | MSV-20 |
| C-TM5 | C-TM2 | C-TM3 | 10 AWG #18 Power Containers | MSV-10 |
| C-TM6 | C-TM2 | C-TM3 | 20 AWG #20 Container Measure- ments | MSV-20 |
| C-TM7 | C-TM3 | C-TM4 | 10 AWG #18 Power Containers | MSV-10 |
| C-TM8 | C-TM3 | C-TM4 | 20 AWG #20 Container Measure- ments | MSV-20 |
| C-TM9 | C-TM15 | C-TM11A | 70 AWG #20 Stbd. Signals | MSV-70 |
| C-TM10 | C-TM14 | C-TM11B | 70 AWG #20 Port Signals | MSV-70 |
| C-TM11 } C-TM12 } | Deleted due to cable rerouting. | | | — |
| C-TM13 | C-TM5 | C-TM12 | 20 AWG #20's FWD. Accel. | MSV-20 |
| C-TM14 | C-TM6 | C-TM12 | 20 AWG #20's Stern Accel. | MSV-20 |
| C-TM15 | C-TM7 | C-TM12 | 30 AWG #20's Midships Motions | MSV-30 |

NOTE: All cables overall shielded with rubber or vinyl jacket.

TABLE NO. 3

S.S. BOSTON SHIPBOARD CABLING

(Continued)

| Cable No. | From Junction Box | Junction Box | Size/Function | Cable Type |
|-----------|------------------------------------|-------------------|--------------------------------------|------------------|
| C-TM16 | C-TM16 | C-TM13 | 6 Cond. & Shielded | TTRSA-6 |
| C-TM17 | Hotel Service | Power Panel CTM-1 | PR Bridge Communications as Required | TSGA-23 |
| C-TM18 | Bow Acceleration Box | C-TM5 | 20 AWG #20 Bow Accelerations | MSV-20 |
| C-TM19 | Stern | C-TM6 | 20 AWG #20 Stern Accelerations | MSV-20 |
| C-TM20 | Midships Acceleration Box | C-TM7 | 12 AWG #20 Heave & Sway | Alpha 1255/12 |
| C-TM21 | Midships Pendulum Box | C-TM7 | 20 AWG #20 Pitch-Roll | MSV-20 |
| C-TM22 | Port Topside Housing | C-TM14 | 12 AWG #20 Port Topside Stress | Alpha 1255/12 |
| C-TM23 | Port Under-side Housing | C-TM14 | 12 AWG #20 Port Underdeck Stress | Alpha 1255/12 |
| C-TM24 | Port Torsion Housing | C-TM14 | 8 AWG #20 Port Torsion | Belden #8418 |
| C-TM25 | Port Displacement Gage | C-TM14 | 4 AWG #20 Port Displacement | Belden #8424 |
| C-TM26 | Port Side Weld Gage | C-TM14 | 8 AWG #20 Side Weld Stress | Belden #8418 |
| C-TM27 | Stbd. Underdeck Housing | C-TM15 | 12 AWG #20 Stbd. Underdeck Stress | Alpha 1255/12 |
| C-TM28 | Stbd. Topside Housing | C-TM15 | 12 AWG #20 Stbd. Topside Stress | Alpha 1255/12 |
| C-TM29 | Stbd. Underdeck and Box Beam Gages | C-TM15 | 12 AWG #20 Stbd. Tunnel Stresses | Alpha 1255/12 |
| C-TM30 | Stbd. Disp. Gage | C-TM15 | 4 AWG #20 Stbd. Displacement | Belden #8424 |
| C-TM31 | Stbd. Side Plate Gage | C-TM15 | 8 AWG #20 Stbd. Side Stress | Belden #8418 |
| C-TM32 | Stbd. Torsion Gage | C-TM15 | 8 AWG #20 Stbd. Torsion | Belden #8418 |
| C-TM33 | Bow Coaming Gages | C-TM4 | 12 Cond. AWG #20 Bow Stresses | Alpha 1255/12 |

TABLE 4
CHARACTERISTICS OF SS BOSTON

| | |
|------------------------------------|--|
| Original Name: | GEN. M.M. PATRICK |
| Builder: | Kaiser Richmond (Hull #16) |
| Converter: | Todd Shipyards Corporation Galveston Division (Hull #87) |
| Type: | C4-SA1 converted to C4-X2 Container Ship |
| Official Number: | 511585 |
| Length Overall: | 522' - 10 1/2" |
| Length Between Perpendiculars: | 496' - 0" |
| Breadth, Molded: | 71' - 6" |
| Depth, Molded to Upper Deck @Side: | 45' - 6" |
| Depth, Molded to Second Deck: | 35' - 0" |
| Depth Molded to Tank Top: | 5' - 0" |
| Tonnage (U.S.) Gross: | 11,521.77 |
| Net: | 7,607.00 |
| Draft Scantling (Full Load): | 30' - 6" |
| Full Load Displacement: | 20,250 Tons S. Water |
| Draft Light Ship: | 17' - 8" |
| Dead Weight: | 9,317 |
| Light Load Displacement: | 10,933 Tons S. Water |
| Center of Gravity Full Load: | l.c.g. 1.35' aft amidships, v.c.g. 27.04' above base line |
| Light Ship: | l.c.g. 1.13' fwd amidships, v.c.g. 18.2' above base line |
| Machinery: | Steam Geared Turbine |
| Shaft Horsepower - Max. Cont. | 9,900 S.H.P. |
| Propeller (1) | 5 Bladed 21' - 8" Dia. |
| Container Capacity (No.) | 360 |
| Container Geometry: | L - 35' - 0" W - 8' - 0" H - 8' - 6 1/2" |

APPENDIX A

TORSION TRANSDUCER INSTRUMENTATION

In the discussion below consideration is given to the location and electrical arrangement of the strain gage bridge installed for the measurement of the shear stress due to torsion about the longitudinal axis. The influence of the existing stresses is evaluated demonstrating the exclusion of the effect of other stresses on the torsional measurement.

A. STRESSES PRESENT

1. Shear

(a) Torsion around longitudinal axis .

(1) Shear stresses present in main deck, sides and bottom;
no shear in area of gunwales and turn of bilge.

(2) Gunwale and turn-of-bilge stresses tensile at twice the frequency of torsion

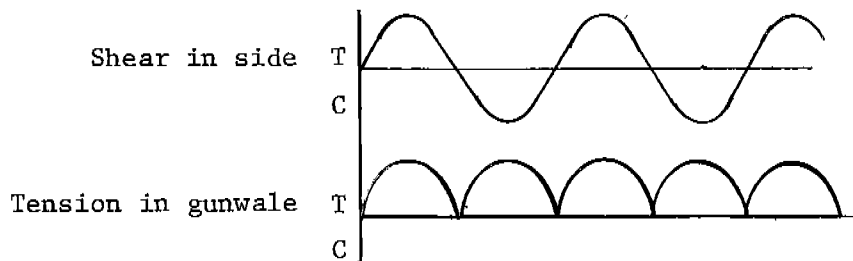

(3) Shear stresses fairly uniform, dropping sharply to zero at gunwales and turn-of-bilge.

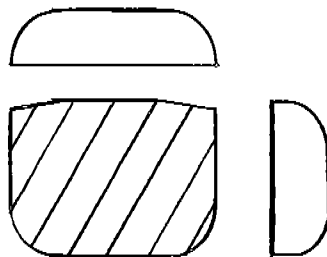

- (b) Pitching motion induces shear in sides, none in deck or bottom.

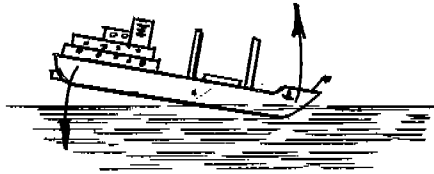

- (c) Yawing induces shear in deck and bottom, none in sides.

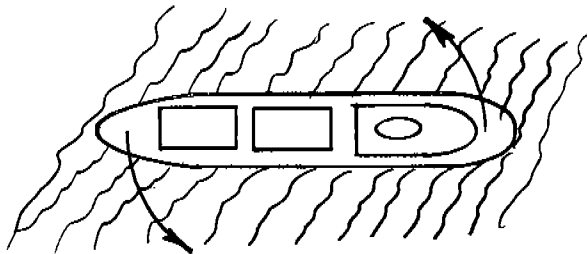

2. Bending

- (a) Longitudinal in vertical plane - main deck and sides above neutral axis in compression while bottom and sides below neutral axis in tension.
- (b) Longitudinal in horizontal plane - port side and portside of deck and bottom in compression while starboard side and starboard side of deck and bottom in tension.

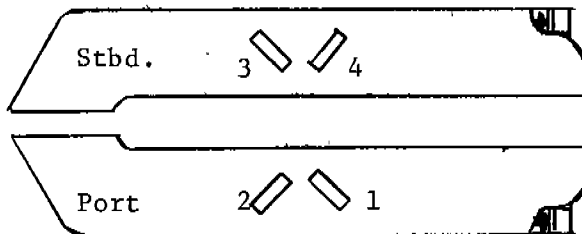
B. GAGE PLACEMENT AND HOOKUP

Strain gages are mounted at midships close to neutral axis at 45° to longitudinal axis. Gages 1 and 2 are on port side, gages 3 and 4 are on starboard side. Gages mounted $/\backslash$ or $\backslash/$ to keep them same distance from neutral axis.

Table 1

SUMMARY OF STRESSES INDUCED IN EACH STRAIN GAGE OF THE TORSION BRIDGE

| Induced Stress | STRAIN GAGE | | | | Net Stress Measured |
|--|-------------|---|---|---|---------------------|
| | 1 | 2 | 3 | 4 | |
| Torsion-Long. Axis | C | T | C | T | Torsion |
| Shear-Pitching | C | T | T | C | None |
| Shear-Yawing | 0 | 0 | 0 | 0 | None |
| Bending-Horizontal | C | C | T | T | None |
| Bending-Vertical (neutral axis) | 0 | 0 | 0 | 0 | None |
| Bending Vertical (off neutral axis) | C | C | C | C | None |

C = compression

T = tension

0 = none

Note 1: Values of T and C along horizontal rows are of equal magnitude.

Note 2: See Torsional Bridge arrangement on next page.

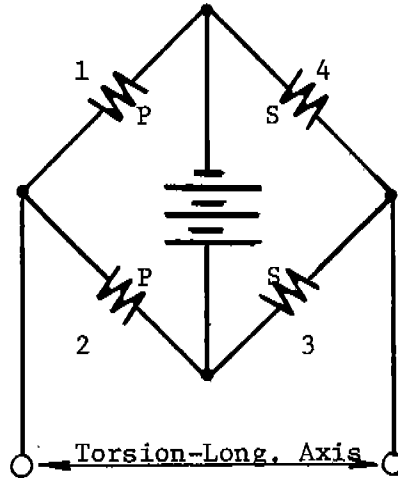

C. DISCUSSION

1. If gages are located on neutral axis, vertical bending stresses are zero.
2. If gages are off neutral axis, vertical bending is present, but in phase. The two portside gages cancel one another as do the starboard side gages.
3. In similar manner horizontal bending is self-canceling on each side.
4. Plating unfairness is thus not a factor with respect to bending, since gage connections will not measure bending. Hence, no requirement for gages on each side of plating.
5. Shear stresses due to yawing are not present in the sides.
6. Shear stresses due to pitching are out of phase in each side and thus additive; however, one side is subtractive from the other because of bridge hookup.
7. Shear stresses due to torsion around the longitudinal axis are additive on each side and from side to side giving an output four times that which could be obtained with one active gage.
8. The bridge is inherently temperature-compensated.

D. CONCLUSION

The instrumentation described in paragraph B will best accomplish the stated aim of monitoring torsional shear stress independent of other stress influences.

APPENDIX B

TRANSDUCER SPECIFICATIONS

1. Stress Gages

BLH Electronics, Inc., Type FAB-28-S6

Longitudinal Gage

Resistance: 350.0 ± 2.5 Ohms

Gage Factor: $2.06 \pm 1\%$

Lateral Gage

Resistance: 98.0 ± 1.0 Ohms

Gage Factor: $2.05 \pm 1\%$

Poisson Ratio: $.28 \pm 1\%$

Stress Gage Factor: $1.48 \pm 1\%$

2. Torsion Gages

BLH Electronics, Inc., FABD-25-12S6

Gage Factor: $2.02 \pm 1\%$

Resistance: $120.0 \pm .2$ Ohms

3. Bow and Stern Accelerometers

Setra Inc., Model 100

Range: $\pm 5g$

Maximum Static Acceleration: $\pm 100g$

Approximate Natural Frequency: 490 Hz

Transverse Acceleration Response: $<0.01g/g$

Excitation: 6 VDC at 20 ma

Full Range Output: ± 1.5 VDC

Output Impedance: 400 Ohms

4. Midships Accelerometers

Satham Instruments, Inc., Model A3-2.5 - 350

Range: $\pm 2.5g$

Nominal Bridge Resistance: 350 Ohms

Approximate Natural Frequency: 55 Hz

Transverse Acceleration Response: $0.02g/g$

Excitation: 11 Volts DC or AC (RMS)

Full-Scale Output: ± 20 mv

Used with Satham Instruments

Model CA9-56 Strain Gage Signal Amplifier

with an output of ± 2.5 VDC.

5. Midships Pitch-and-Roll Signals

Humphrey Inc., Pendulum Transducers, Model CP17-0601-1

Range: $\pm 45^\circ \pm 0.5^\circ$

Resistance: 2000 Ohms $\pm 5\%$

Power Dissipation: 0.5 watt at 130°F

Accuracy: $\pm 1\%$ with straight line approximation

Natural Frequency: 2 Hz

6. Displacement Transducers

Hewlett Packard, Model 7DCDT-050

Full-Scale Output: 1.5 VDC

Range: ± 0.050 inches

Scale Factor: 30 V/in

Maximum Nonlinearity: $\pm 0.5\%$ FS

Excitation Voltage: 6 VDC Nominal

Output Impedance: 2.2 K Ohms

Frequency Response: 3 db down at 350 Hz

7. Wave Data Acquisition System

Eastech Limited, Windsor, Nova Scotia, Model 440

Used with Model 266 Wave Buoys.

Data recorded as positive pulses approximately 3 milliseconds in duration, approximately 1.5 volts peak at 30 pulses per second at zero acceleration.

APPENDIX C
AMPEX FR-1300
INSTRUMENTATION
RECORDER

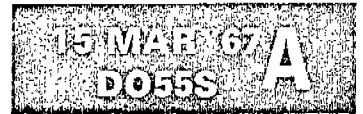

AMPEX FR-1300

INSTRUMENTATION RECORDER

PERFORMANCE SPECIFICATIONS

General Description

The Ampex FR-1300 is a compact, lightweight portable recorder, available in 7 or 14-channel versions. It features an integral capstan servo system that assures speed accuracy under variable power conditions and provides electrical switching over a range of six speeds. For applications requiring precisely accurate speeds, or where it is desired to record and reproduce on different recorders under unpredictable voltage conditions, a control track generator/demodulator module can easily be added to the integral capstan servo system to provide a complete record/reproduce tape speed servo control system (Speedlock). Transport control circuitry is completely interlocked to prevent tape damage if the recorder is operated carelessly or accidentally. Interchangeability of electronics is possible with nine other Ampex recorders using ES-100 electronics. Signal compatibility with earlier recorders having 100 Kc direct or 10 Kc FM capability is also provided. A rack mounted version is available.

Tape Transport

Tape Speeds: 60, 30, 15, 7½, 3¾, 1⅞ ips standard. All six transport speeds are selected by a single front panel control. All speeds are synchronously controlled by a phase-locked servo system on capstan drive motor. Other fixed or variable speeds on special order.

Capstan Speed Accuracy: ±0.05% maximum, long term, when using the internal crystal reference. Frequency standard is accurate to ±0.01%, long term.

Tape Speed Deviation: ±0.25%.

Reels: The FR-1300 tape transport accommodates 10½-inch reels, Ampex Precision or NAB.

Tape Specifications: Available in versions for ½ or 1-inch tape of 1 mil or 1½ mil Polyester, or 1½ mil Acetate. Stated performance guaranteed only when using recommended Ampex Instrumentation Tape.

Controls: Illuminated pushbuttons for Record, Drive, Stop, Forward and Rewind. All functions may be remotely controlled. Control circuitry is completely interlocked so that recorder can be switched from any mode to any other mode without damaging the tape.

Fast Wind Time: For 10½-inch reel, with 3600 feet of tape, approximately 3.0 minutes at 60 cycles per second (3.5 min. at 50 cps).

Start Time: Time required from start command to meet flutter specifications is as follows:

| Speed (ips) | Time |
|---------------------|-----------|
| 60 | 8 seconds |
| 30 | 6 seconds |
| 15 and lower speeds | 4 seconds |

Stop Time: Maximum of 1.5 seconds at 60 ips tape speed; shorter stop times with lower tape speeds.

Flutter: Maximum cumulative flutter (% peak-to-peak):

| Tape Speed (ips) | Bandpass (cps) | Flutter (%) | Bandpass (cps) | Flutter (%) |
|------------------|----------------|-------------|----------------|-------------|
| 60 | 0.2 to 10,000 | 0.6 | 0.2 to 312 | 0.20 |
| 30 | 0.2 to 5,000 | 0.6 | 0.2 to 312 | 0.25 |
| 15 | 0.2 to 2,500 | 0.6 | 0.2 to 312 | 0.4 |
| 7½ | 0.2 to 1,250 | 0.75 | 0.2 to 312 | 0.6 |
| 3¾ | 0.2 to 625 | 1.2 | 0.2 to 312 | 1.2 |
| 1⅞ | 0.2 to 312 | 1.5 | 0.2 to 312 | 1.5 |

Heads

Gap Scatter: Trailing edges for record heads (or gap centers for reproduce heads) within a band 100 microinches wide (0.0001 inch).

Gap Azimuth: All stacks within ±1 minute of arc perpendicular to head base plate.

Track Dimensions: Track width is 0.050 inch; tape track spacing 0.070 center (IRIG Standard). Other heads on special order.

Number of Tracks: 7 on ½ inch; 14 on 1 inch (IRIG Standard). Other heads on special order.

Interstack Spacing: 1.5 ±0.0005 inch, gap to gap.

Direct Record/Reproduce System

Frequency Response:

| Tape Speed (ips) | Bandwidth | S/N* (db) | |
|------------------|-------------------------|---------------------|------------|
| | | Bandpass Filtered** | Unfiltered |
| 60 | 300 cps to 300 Kc ±3 db | 35 | 31 |
| 30 | 150 cps to 150 Kc ±3 db | 34 | 30 |
| 15 | 100 cps to 75 Kc ±3 db | 32 | 27 |
| 7½ | 50 cps to 38 Kc ±3 db | 30 | 22 |
| 3¾ | 50 cps to 19 Kc ±3 db | 29 | 22 |
| 1⅞ | 50 cps to 10 Kc ±3 db | 28 | 22 |

* For an all Direct system only. In a mixed Direct/FM system, Direct S/N and crosstalk may be affected.
** Measured at output of a bandpass filter having 18 db/octave attenuation beyond limits stated.

RMS Signal-to-Noise Ratio: See table.

Harmonic Distortion: Less than 1.2% total of a 1 Kc signal recorded at 60 ips.

Input Level: 1.0 volt rms nominal (0 dbv) to produce normal recording level; operable from 0.2 to 10 volts rms by adjustment of input potentiometer.

Input Impedance: Nominal 50 K ohms resistive, in parallel with 150 pF, unbalanced to ground.

Output Level: 1.0 volt rms nominal (0 dbv), across a 600 ohms or greater impedance.

Output Impedance: Less than 50 ohms, unbalanced to ground.

FM Record/Reproduce System

Frequency Response:

| Tape Speed | Frequency Response (within 1.0 db) | S/N Ratio RMS | Total Harmonic Distortion |
|------------|------------------------------------|---------------|---------------------------|
| 60 ips | 0 to 20,000 cps | 46 db | 1.2% |
| 30 ips | 0 to 10,000 cps | 46 db | 1.2 |
| 15 ips | 0 to 5,000 cps | 45 db | 1.2 |
| 7½ ips | 0 to 2,500 cps | 45 db | 1.2 |
| 3¾ ips | 0 to 1,250 cps | 42 db | 1.5 |
| 1⅞ ips | 0 to 625 cps | 40 db | 1.8 |

RMS Signal-to-Noise Ratio (at center carrier): See table.

Harmonic Distortion: See table.

DC Drift: Less than ±0.5% of full deviation over a four-hour period after warmup (10 minutes). Less than 2% in 8 hours with temperature variations between +40°F and +125°F.

continued

APPENDIX C (cont'd)

FM Record/Reproduce System (con't)

Record/Reproduce Voltage Linearity: $\pm 0.75\%$ of full band, of a zero-based straight line.

Input Level: Input of 1 volt rms (0 dbv) to produce $\pm 40\%$ deviation; operable from 0.5 to 25 volts rms by adjustment of input potentiometer.

Input Impedance: Nominal 20,000 ohms resistive, in parallel with 150 pF, unbalanced to ground.

Output Level: 1.0 volt rms (nominal) into 10 K ohms or greater load impedance.

Output Impedance: 600 ohms, unbalanced to ground.

PDM Record/Reproduce System (IRIG Compatible)

System Pulse Characteristics:

| Tape Speed (ips) | Pulse Duration in Microseconds | | Pulse Accuracy in Microseconds Over Specified Pulse Widths |
|------------------|--------------------------------|--------|--|
| | Min. | Max. | |
| 60 | 20 | 10,000 | ± 2.0 (30 to 900 μ sec duration) |
| 30 | 30 | 10,000 | ± 2.0 (45 to 900 μ sec duration) |
| 15 | 60 | 10,000 | ± 3.0 (60 to 2,000 μ sec duration) |
| 7½ | 120 | 10,000 | ± 10.0 (120 to 3,000 μ sec duration) |

Input Level: 1 volt peak-to-peak rectangular wave 20 microseconds to 10,000 microseconds pulse duration, operable from 0.75 to 20 volts peak-to-peak.

Input Impedance: 20,000 ohms nominal paralleled by 150 pF maximum, unbalanced to ground.

Output Level: 20 to 24 volts peak-to-peak across 1000 ohms and 0.001 mfd.

Output Impedance: Less than 100 ohms, unbalanced to ground.

Output Rise and Fall Time: 2 microseconds maximum (from 10% to 90% amplitude level).

Servo Tape Speed Control System (Speedlock)

Frequency Standard Accuracy: $\pm 0.01\%$, long term.

Speed Correction Range: $\pm 2\%$ of nominal.

Servo Tape Speed Control System (con't)

Time Displacement Error:

| Tape Speed | Error |
|------------|------------------|
| 60 ips | 100 microseconds |
| 30 ips | 150 microseconds |
| 15 ips | 200 microseconds |

Synchronization Time: After 10-minute warmup.

| Tape Speed | Time |
|------------|-----------|
| 60 ips | 8 seconds |
| 30 ips | 6 seconds |
| 15 ips | 4 seconds |

Power Requirements

Voltage: 105 to 125 volts, single phase, 48 to 62 cps AC (with Frequency Standard).

Power Consumption: Less than 325 watts steady state for a 14-track record/reproduce system. Starting surges up to 400 watts may be encountered.

Environment

Temperature: Operating: 5°C to 52°C (40°F to 125°F)
Storage/non-operating: -30°C to 66°C (-20° to 150°F)

Altitude: Operating: 15,000 feet (4600 m).
Non-operating: 50,000 feet (15,000 m).

Relative Humidity: 5 to 95%, non-condensing, both operating and non-operating.

Vibration: Normal handling and transportation only.

Physical Characteristics

Size: Portable case 24 inches (61 cm) high, by 18 inches (46 cm) wide, by 12½ inches (31 cm) deep, for complete 14-track record/reproduce system and capstan servo.

Vertical Rack Space Required: Rack mounted version: Transport 24½ inches (62.2 cm), electronics tray 5¼ inches. Each electronics tray accommodates up to 14 record or reproduce modules, plus 3 auxiliary modules.

Weight: Portable version: Approximately 110 lbs. (50 kg) for 7-track system.

METRIC CONVERSION TABLES

Applicable to all Ampex recorders—specific items may not apply to the unit described in this sheet.

| TAPE SPEEDS | | TAPE DIMENSIONS (Continued) | | | | | | | | |
|---|---|-----------------------------|---------------|------------------------|-------------------------|------|------|------|------|------|
| ips | 1¼ 3¼ 7½ 15 30 60 120 | Length: feet | 600 | 1200 | 1800 | 2500 | 3600 | 5000 | 7200 | 9600 |
| cm/sec | 4.76 9.52 19.05 38.1 76.2 152.4 304.8 | meters | 185 | 366 | 549 | 762 | 1097 | 1524 | 2195 | 2926 |
| TAPE DIMENSIONS | | HEAD DIMENSIONS | | Track Width & Spacing* | | | | | | |
| Reels: inches | 14 10¼ 7 5¼ 5 | Gap Scatter | 100 | Interstack Spacing* | inches 1.5 ± 0.0005 | | | | | |
| cm | 35.56 26.67 17.78 14.62 12.70 | microinches | 0.00254 | cm | 3.81 ± 0.00127 | | | | | |
| Widths: inches | ¼ ½ ¾ 1 2 | mm | 0.0254 0.0381 | inches | 0.050 0.070 | | | | | |
| cm | 0.635 1.27 1.905 2.54 5.08 | | | mm | 1.27 1.778 | | | | | |
| Base Thicknesses: inches | 1 mil 1.5 mil | | | | * (IRIG) | | | | | |
| mm | 0.0254 0.0381 | | | | | | | | | |
| STANDARD PANELS FOR 19-INCH (48.26 cm) RACK | | | | | | | | | | |
| in. | 1¼ 3¼ 5¼ 7 8¼ 12¼ 14 15¼ 17½ 19¼ 21 35 | | | | | | | | | |
| cm | 4.45 8.89 13.34 17.78 22.23 31.12 35.56 40.01 44.45 48.9 53.34 88.9 | | | | | | | | | |

Ampex Corporation reserves the right to change specifications without notice or obligation. This specification sheet supersedes all previous specifications, stated or implied.

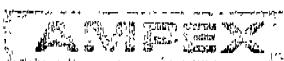

AMPEX CORPORATION

401 Broadway • Redwood City • California • U.S.A. • 94063

Australia, Canada, England, France, Germany, Hong Kong, Mexico, Switzerland

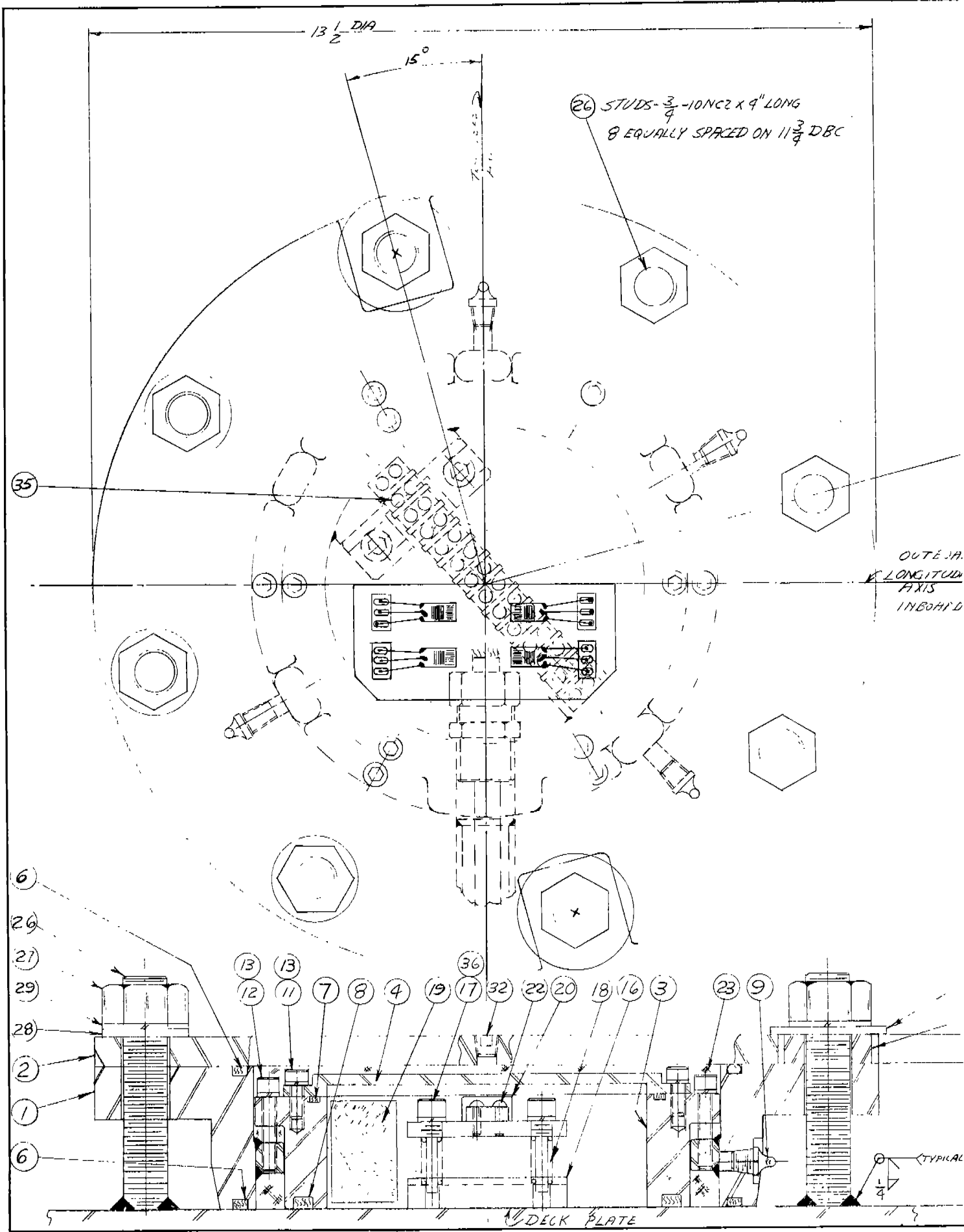

13 1/2 DIA

15°

(26) STUDS - 3/4 - 10NC2 X 9" LONG
8 EQUALLY SPACED ON 11 3/4 DBC

OUTER JA.
& LONGITUD.
AXIS
IN BOARD

(35)

(6)

(26)

(27)

(29)

(28)

(2)

(1)

(6)

(13)

(13)

(7)

(8)

(4)

(19)

(17)

(32)

(22)

(20)

(18)

(16)

(3)

(23)

(9)

(36)

DECK PLATE

TYPICAL

VERTICAL LONGITUDINAL BENDINGS

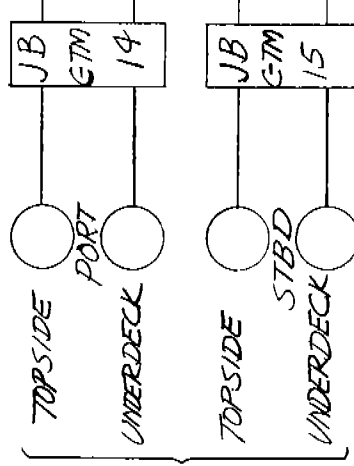

HORIZONTAL LONGITUDINAL BENDINGS

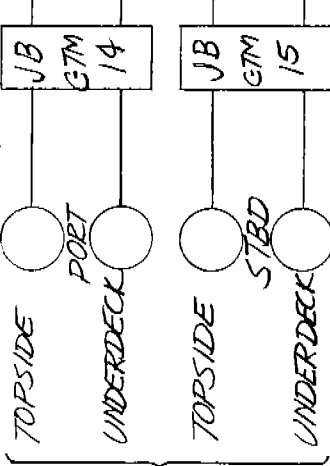

TORSIONAL STRESSES

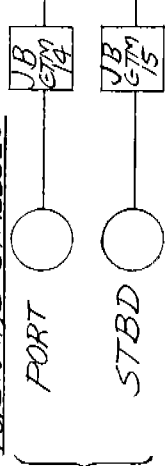

ADDITIONAL STRESSES

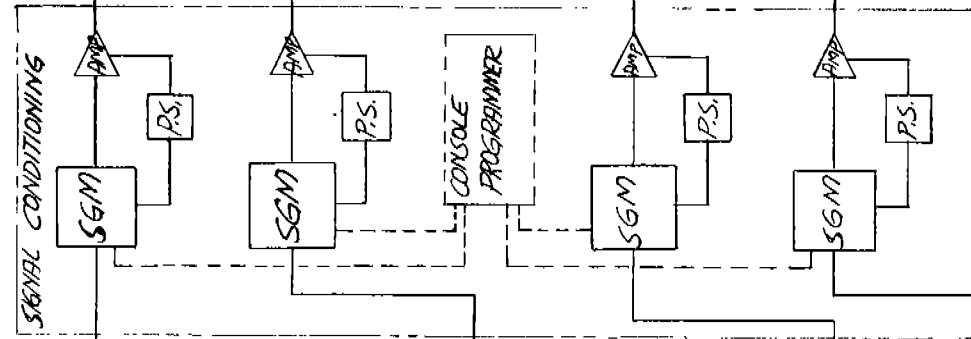
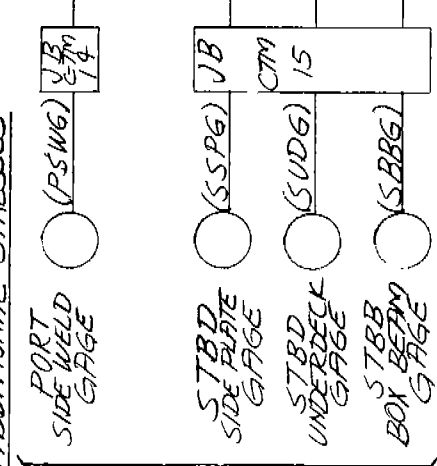

STRESS MONITORING PANEL

RECORDER PATCH PANEL

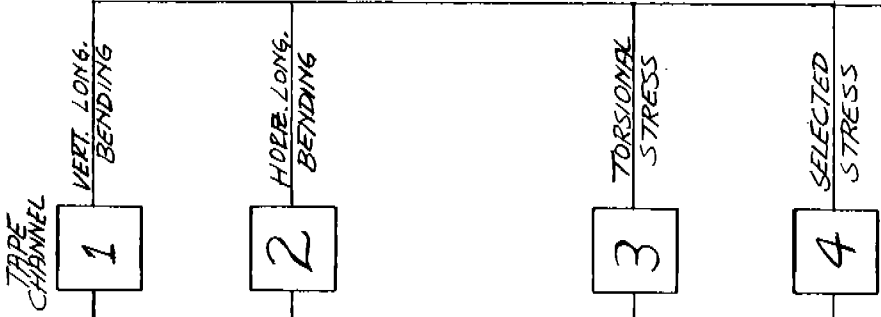

TAPE CHANNEL

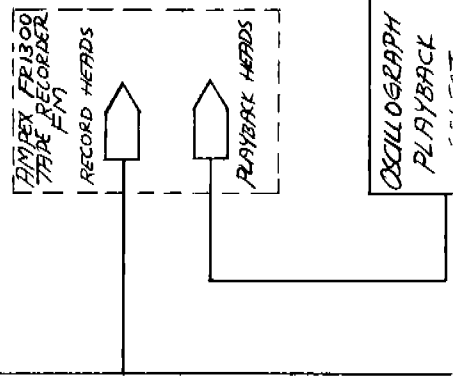

SELEC 1

OSCILLOGRAPH
6 CHANNEL
MAXIMUM

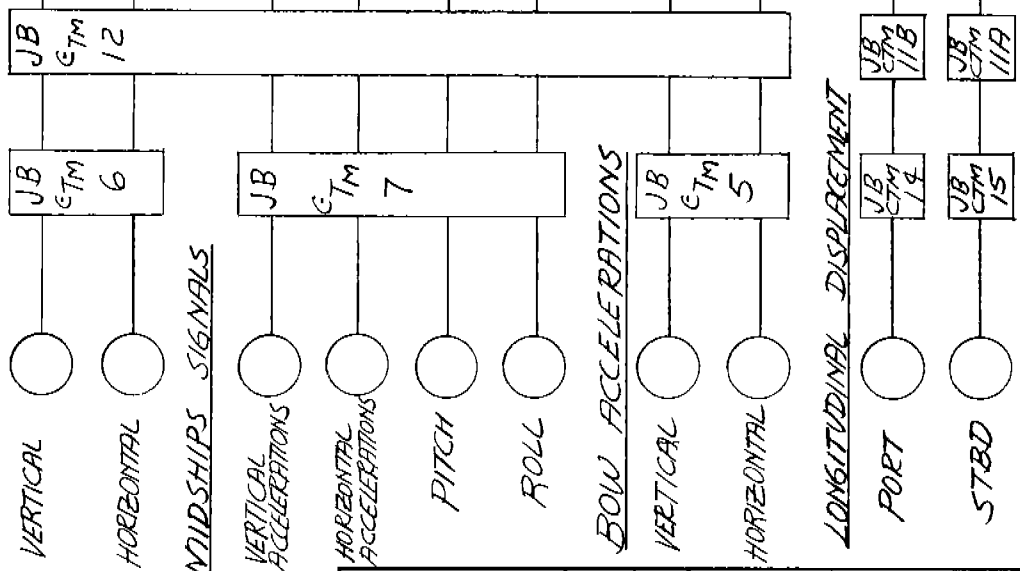
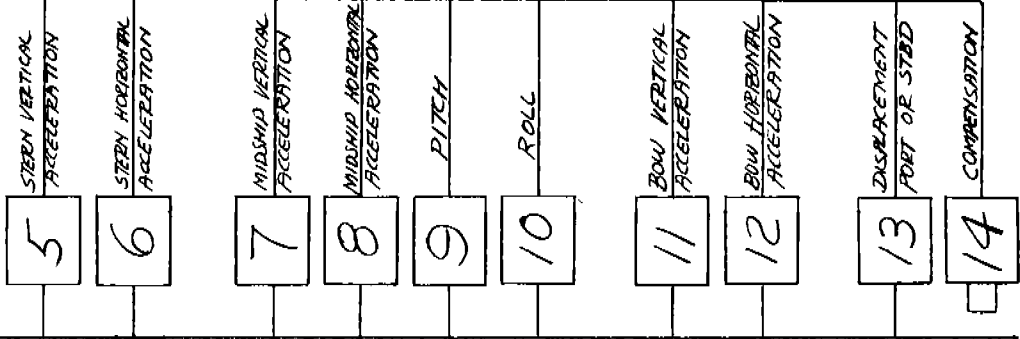

BOW CORNING GAGES
 FORE/AFT
 ATHWARD SHIPS

STERN ACCELERATIONS

MIDSHIPS SIGNALS

BOW ACCELERATIONS

LONGITUDINAL DISPLACEMENT

| | | | | |
|--|-----------|--------------------------|----------------------|--|
| UNLESS OTHERWISE SPECIFIED DIMENSIONS ARE IN INCHES TOLERANCES ON FRACTIONS DECIMALS ANGLES | | DRAFTERMAN LEONE | DATE 11/5/68 |  TELEDYNE MATERIALS RESEARCH A TELEDYNE COMPANY |
| MATERIAL | TREATMENT | ENGINEER P. A. FALLON | APPROVAL 11/21/68 | |
| FINISH | SCALE | PROJECT NO. 1123236 | | DRAWING NO. D-2749 |

**FUNCTIONAL BLOCK DIAGRAM
RECORDING SYSTEM
S.S. BOSTON**

CONSOLE

PROGRAMMER JT PT

CONSOLE CABLE NO. 6
20 CONDUCTOR SHIELDED

| | | | | | | | | | | | | | | | | | | |
|-------|---|------|---|-------|---|------|---|--------------------|----|-----------------|----|-----------------------|----|--------------------|----|--------|----|----|
| 1 | 2 | 3 | 4 | 5 | 6 | 7 | 8 | 9 | 10 | 11 | 12 | 13 | 14 | 15 | 16 | 17 | 18 | 19 |
| + | - | + | - | + | - | + | - | + | - | + | - | + | - | + | - | + | - | + |
| A | B | C | D | E | F | G | H | J | K | L | M | N | P | Q | R | S | T | U |
| PITCH | | ROLL | | HEAVE | | SWAY | | BOW ACCEL VERTICAL | | BOW ACCEL HORIZ | | STERNY ACCEL VERTICAL | | STERNY ACCEL HORIZ | | SHIELD | | |

SIGNALS

CONSOLE CABLE NO. 7
12 CONDUCTOR SHIELDED

| | | | | | | | | | | | |
|-------|---|------|---|-------|---|------|---|-----|----|----|----|
| 1 | 2 | 3 | 4 | 5 | 6 | 7 | 8 | 9 | 10 | 11 | 12 |
| + | - | + | - | + | - | + | - | + | - | + | - |
| A | B | C | D | E | F | G | H | I | J | K | L |
| PITCH | | ROLL | | HEAVE | | SWAY | | BOW | | | |

CAL COMMAND

JUNCTION BOX C-TM12

TO WIRES INDICATED

| | | |
|-------|--------|--------|
| CABLE | C-TM14 | NSV-20 |
| | TM25 | TM26 |
| | TM27 | TM28 |
| | TM29 | SPARE |
| | TM27 | TM28 |
| | TM238 | TM235 |
| | TM236 | TM239 |
| | SPARE | TM185 |
| | TM186 | TM187 |
| | TM188 | TM171 |
| | SPARE | TM205 |
| | TM206 | TM207 |
| | TM208 | SHIELD |

SEE TODD SHIPARDS CORP DRAWING 62448-2 SH3 OF 4

STERNY PARTISHIP FR193

JUNCTION BOX C-TM16

TO WIRES INDICATED

| | | |
|-------|--------|-----------------------|
| CABLE | C-TM19 | 20 CONDUCTOR SHIELDED |
| | TM197 | TM201 |
| | TM205 | TM206 |
| | TM207 | TM208 |
| | SPARE | TM199 |
| | TM209 | TM200 |
| | TM210 | SPARE |
| | SPARE | SPARE |
| | SPARE | TM203 |
| | SPARE | SPARE |
| | TM204 | SPARE |
| | SPARE | TM198 |
| | TM202 | SHIELD |
| | SPARE | SENSE JUMPERS |

WIRES 16-20 NOT TERMINATED EITHER END

J.B. C-TM18

TO WIRES INDICATED

| | | |
|-------|--------|-------|
| CABLE | C-TM13 | NSV20 |
| | TM177 | TM181 |
| | TM185 | TM186 |
| | TM187 | TM188 |
| | SPARE | TM179 |
| | TM189 | TM180 |
| | TM190 | SPARE |
| | SPARE | SPARE |
| | TM183 | SPARE |
| | SPARE | TM184 |
| | SPARE | SPARE |

SENSE JUMPERS

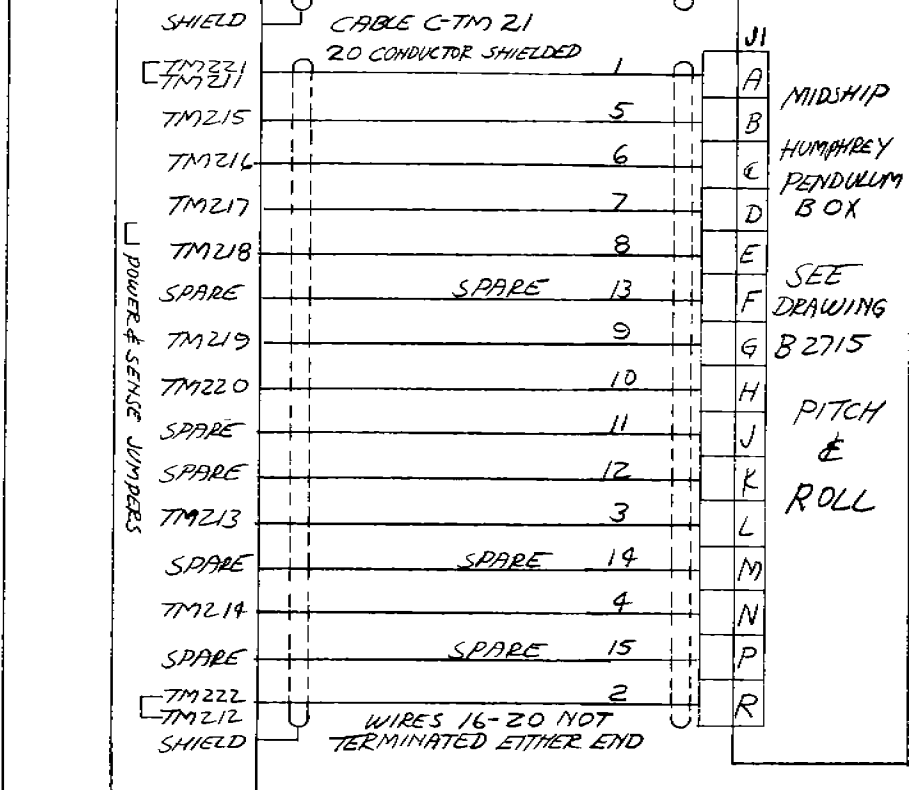
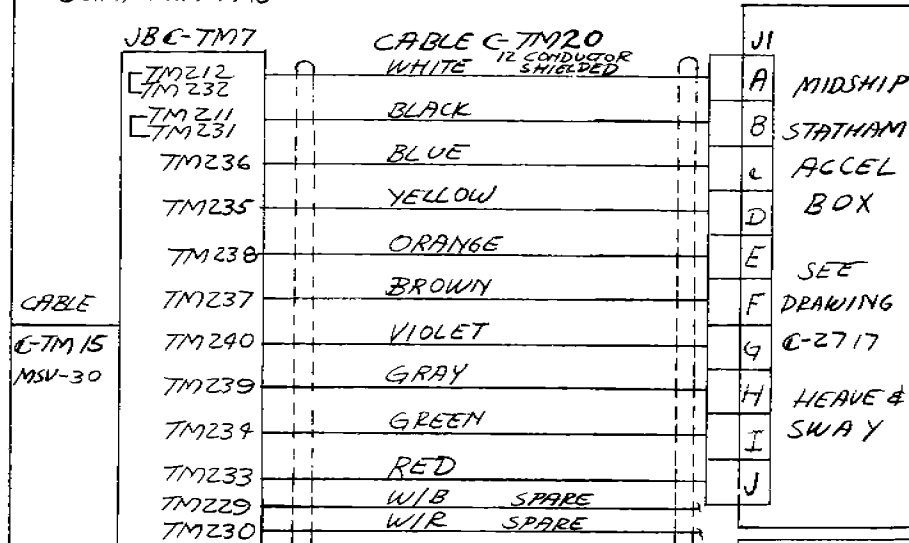
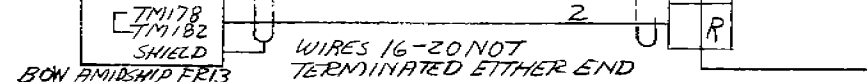
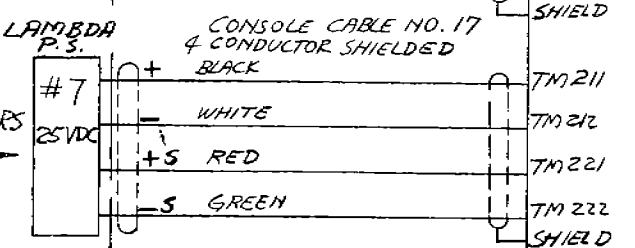
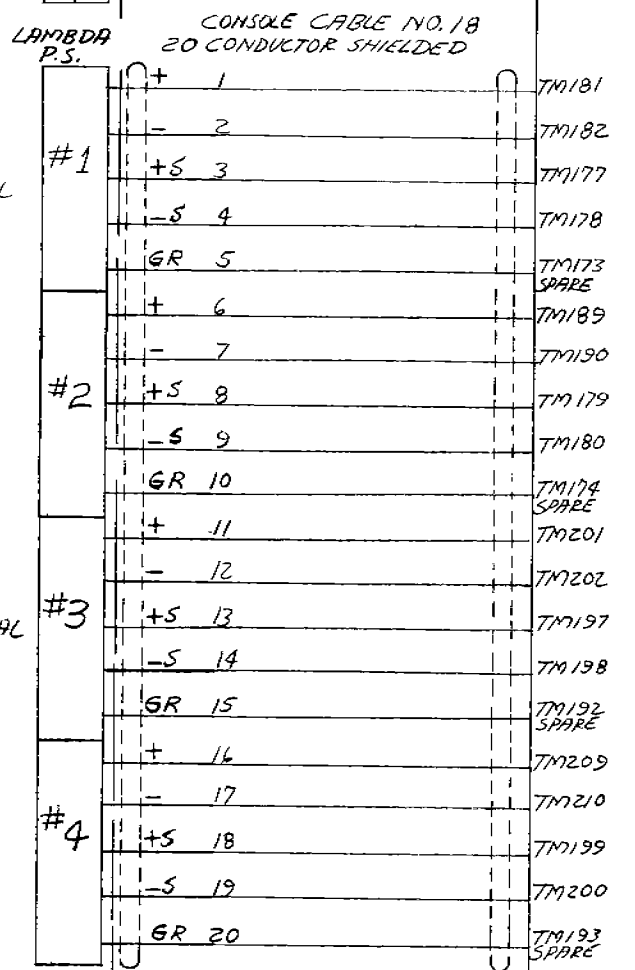
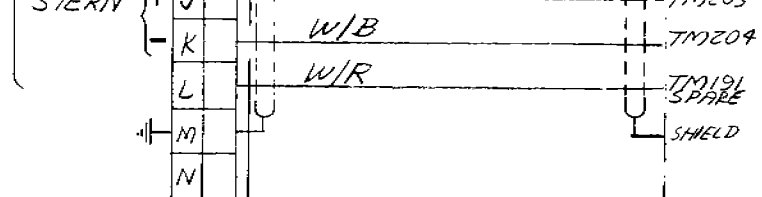

GVDC EACH UNIT WITH REMOTE SENSING

BOW VERTICAL

BOW HORIZ

STERN VERTICAL

STERN HORIZ

MIDSHIP TRANSDUCERS

INSTRUMENT ROOM FR 193

MIDSHIPS FR 112

| | |
|---|------------|
| FINISH | |
| TREATMENT | |
| MATERIAL | |
| UNLESS OTHERWISE SPECIFIED DIMENSIONS ARE IN INCHES FRACTIONS TO DECIMALS ON ANGLES | |
| ENGINEER | DATE |
| APPROVAL | 1/16 |
| SCALE | |
| PROJECT NO. | 1123.236 |
| DRAWING NO. | D-2750-SH1 |
| TELEDYNE MATERIALS RESEARCH | |
| A TELEDYNE COMPANY | |
| FUNCTIONAL FLOW DIAGRAM | |
| BOW, STERN, MIDSHIPS | |

JB CTM-1

JB CTM-2

JB CTM-3

JB CTM-4

CA
12 CO.

CTM-2
MSV-20

CTM-4
MSV-20

CTM-6
MSV-20

CTM-8
MSV-20

CTM-1
MSV-10

CTM-3
MSV-10

CTM-5
MSV-10

CTM-7
MSV-10

STBD TUNNEL
FR 129

STBD TUNNEL
FR 97

STBD TUNNEL
FR 65

STBD TUNNEL
FR 47

TM 21
TM 22
TM 23
TM 24
TM 25
TM 26
TM 27
TM 28
TM 29
TM 30
TM 19
TM 20
SHIELD

SEE TODD SHIPYARDS CORP
DRAWING 62468-2 SH3 OF 4

JB C-TM 10

CONSOLE CABLE NO 14
12 CONDUCTOR SHIELDED

CONDITIONING CHANNEL
SELECT PANEL
CONSOLE

CTM-1
MSV-10

CTM-2
MSV-20

TM 21
TM 22
TM 23
TM 24
TM 25
TM 26
TM 27
TM 28
TM 29
TM 30
TM 19
TM 20
SHIELD

BLACK
WHITE
RED
GREEN
YELLOW
BLUE
BROWN
ORANGE
GRAY
VIOLET
W/B
W/R

P4 J4

A } ACTIVE
B } FORE/AFT
C } COMPENSATING
D }
E SHUNT CAL.
F } ACTIVE
G } AHEAD
H } SHIPS
I } COMPENSATING
J SHUNT CAL.
K SPARE
L SPARE
M
N SHIELD

INSTRUMENT ROOM
FR 193

INTERMEDIATE BOW
JUNCTION BOX

BOW COAMING GAGES

TABLE CPM-33
INDUCTOR SHIELDED

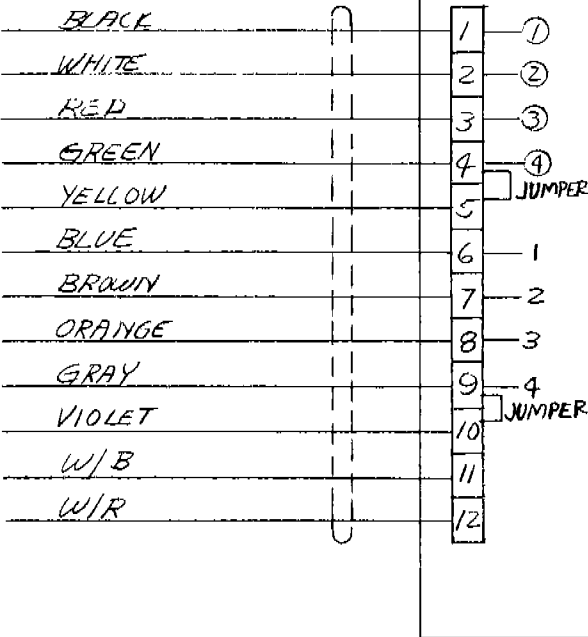

FWD SIDE
STBD CORNER
#2 HATCH COAMING

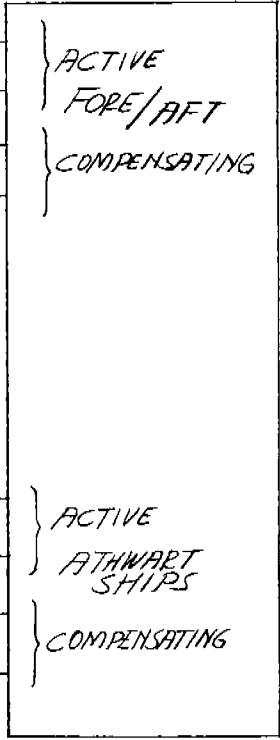
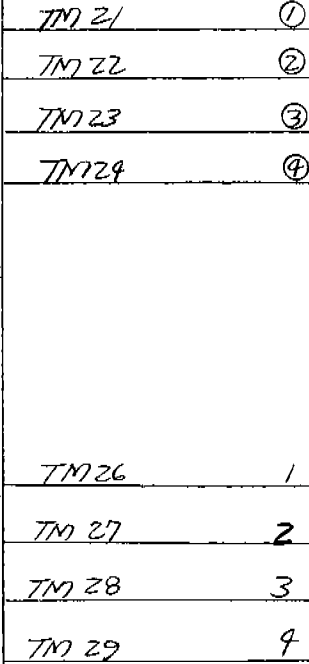

FWD STBD CORNER
#2 HATCH MAIN DECK

| | | | |
|---|------------------------|----------------------|---|
| UNLESS OTHERWISE SPECIFIED DIMENSIONS ARE IN INCHES TOLERANCES ON FRACTIONS DECIMALS ANGLES ± ± ± | DRAFTSMAN LEONE | DATE 11/16/68 |  TELEDYNE MATERIALS RESEARCH A TELEDYNE COMPANY |
| | CHECKER | | |
| MATERIAL | ENGINEER R.A. FELLS | APPROVAL 11/21/68 | FUNCTIONAL FLOW DIAGRAM BOW COAMING GAGES |
| TREATMENT | SCALE | | PROJECT NO. 1123036 |
| FINISH | | | DRAWING NO. D-2750-5H2 |

PORT SIDE
FR 105/106

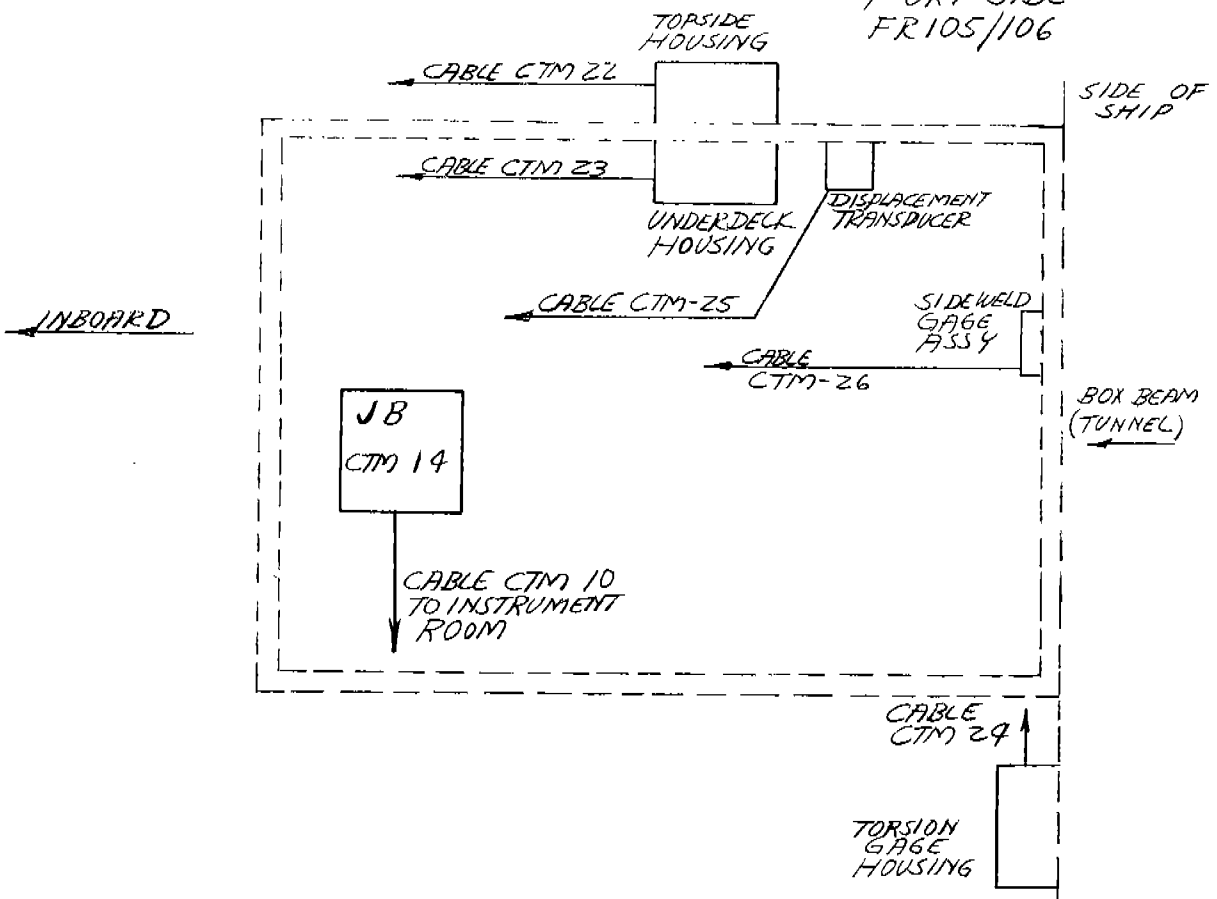

INTERNAL CONNECTIONS OF GAGES
(FOR TOPSIDE, UNDERDECK & TORSION HOUSING)
SEE SHEET 9 THIS DRAWING

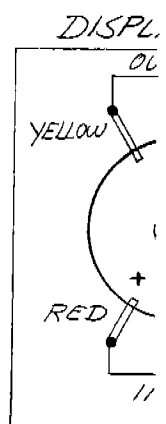
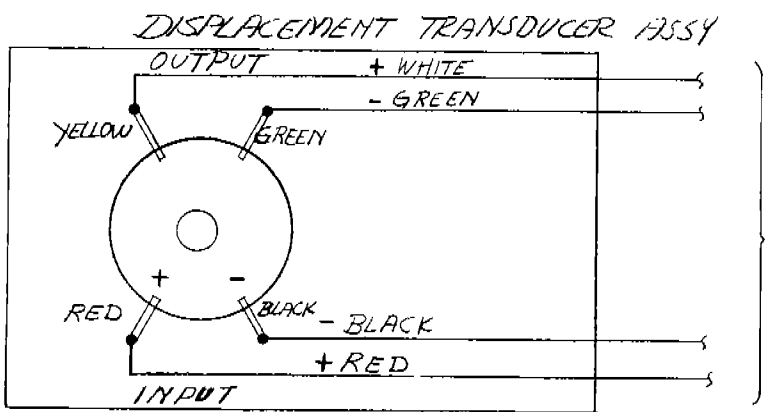
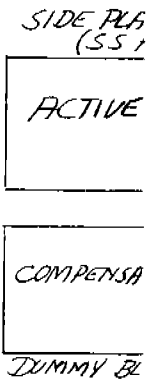
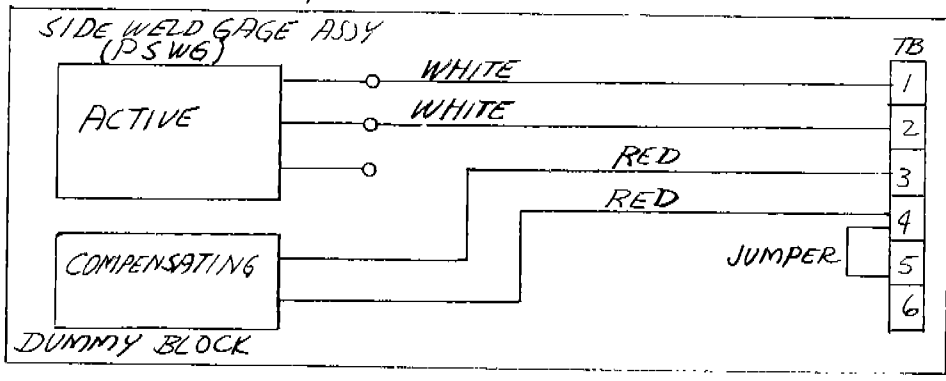

STBD SIDE
FR 105/106

SIDE OF SHIP

BOARD

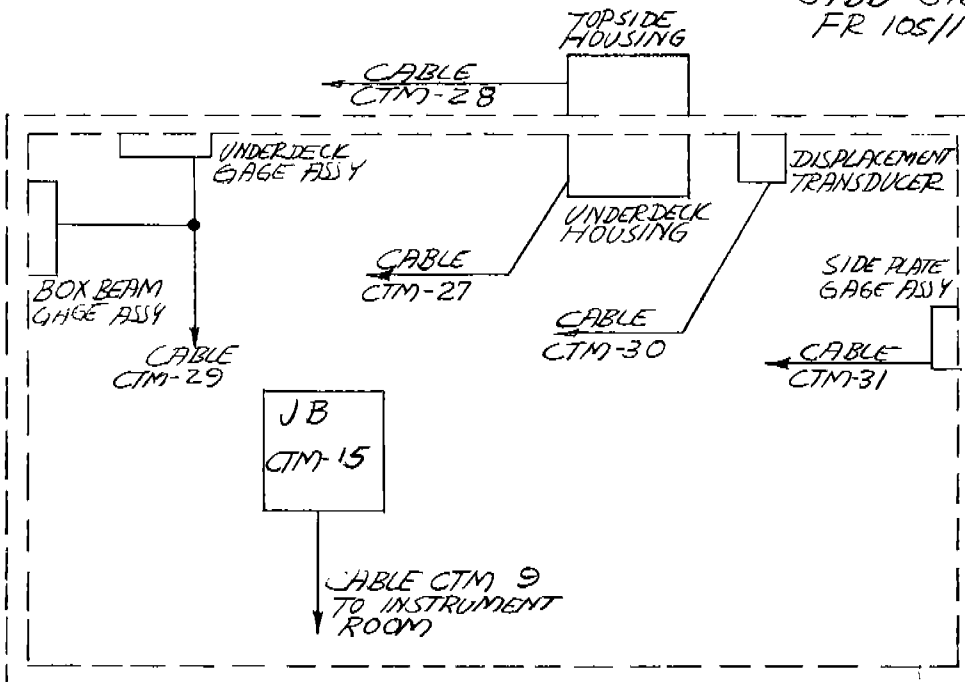

BOX BEAM (FUNNEL)

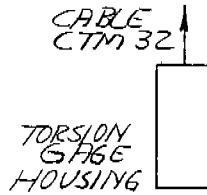

INTERNAL CONNECTIONS OF GAGES
(FOR TOPSIDE, UNDERDECK & TORSION HOUSINGS)
SEE SHEET 9 THIS DRAWING

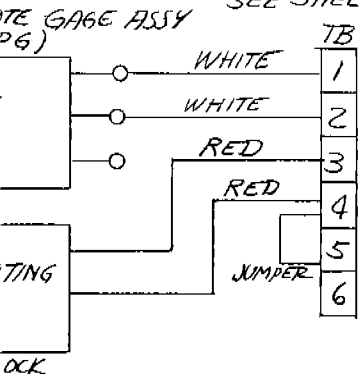

CABLE CTM-31

CABLE CTM-29

UNDERDECK GAGE ASSY (SUDG)

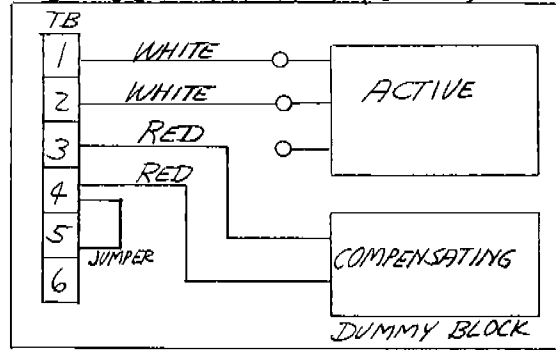

DISPLACEMENT TRANSDUCER ASSY

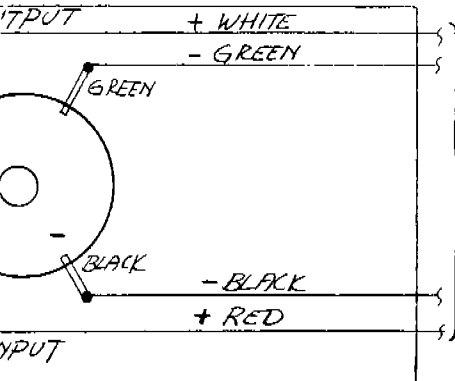

CABLE CTM-30

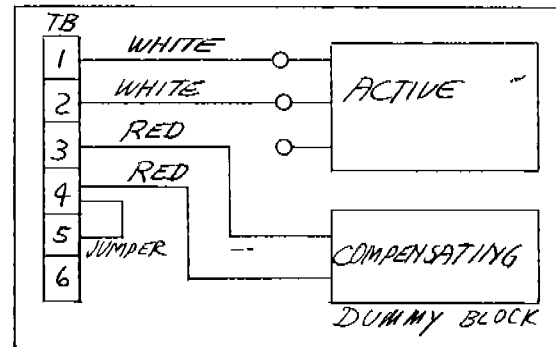

BOX BEAM GAGE ASSY (SBBG)

| | | | |
|---|--------------------------|------------------------|--|
| UNLESS OTHERWISE SPECIFIED DIMENSIONS ARE IN INCHES TOLERANCES ON FRACTIONS DECIMALS ANGLES ± ± ± | DRAFTSMAN TEEDNE | DATE 1/14/68 | TELEDYNE MATERIALS RESEARCH A TELEDYNE COMPANY |
| | CHECKER | | |
| MATERIAL | ENGINEER R. D. FRENCH | DATE 1/21/68 | FUNCTIONAL FLOW DIAGRAM GAGE LOCATIONS & TIE IN |
| TREATMENT | APPROVAL | | |
| FINISH | SCALE | PROJECT NO. 1123j36 | DRAWING NO. D-2750-SH3 |

PORT SIDE

SIDE OF SHIP

TOPSIDE DECK HOUSING FR 105/106

WIRES ①-③ WHITE
WIRES ⑨-⑫ RED

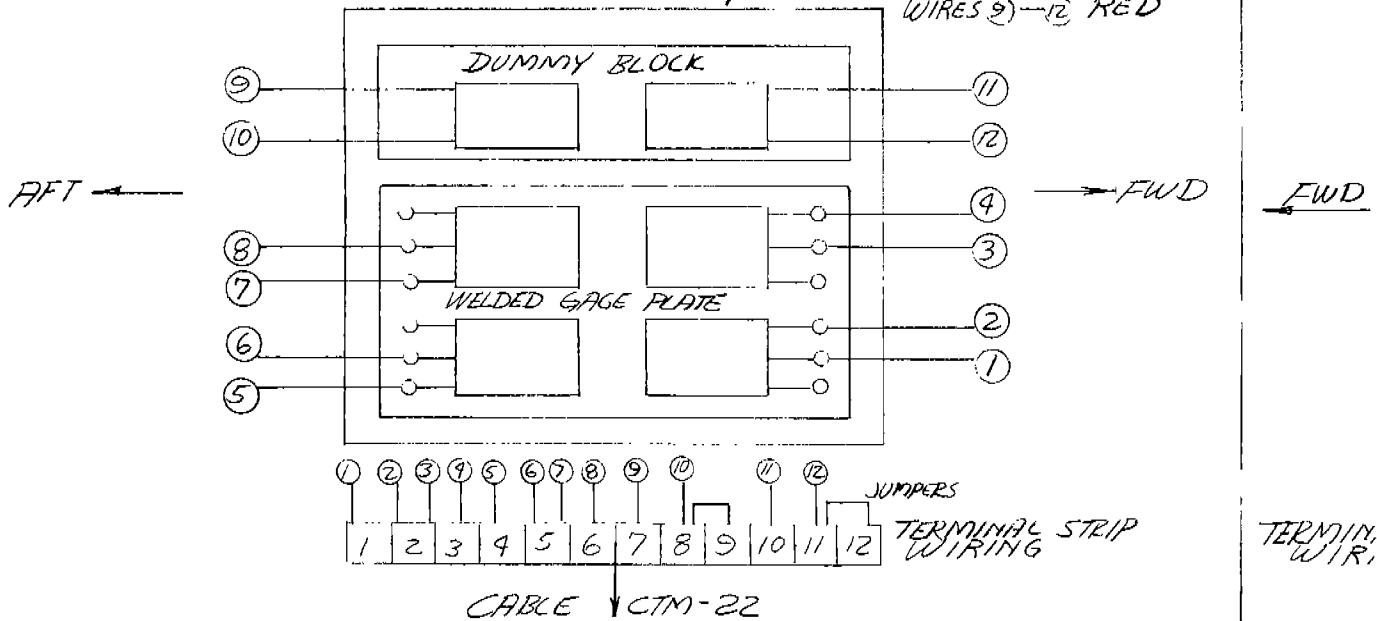

UNDER DECK HOUSING FR 105/106

WIRES ①-⑧ WHITE
WIRES ⑨-⑫ RED

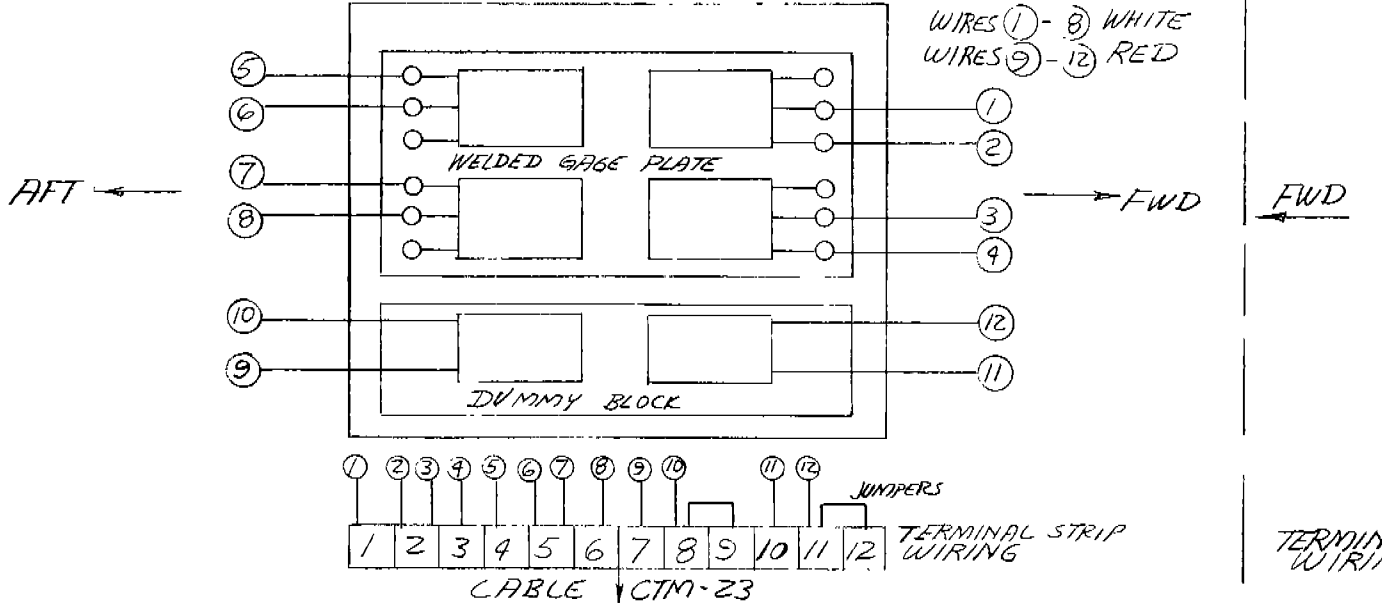

SIDE OF SHIP

TORSIONAL GAGE HOUSING FR 105/106

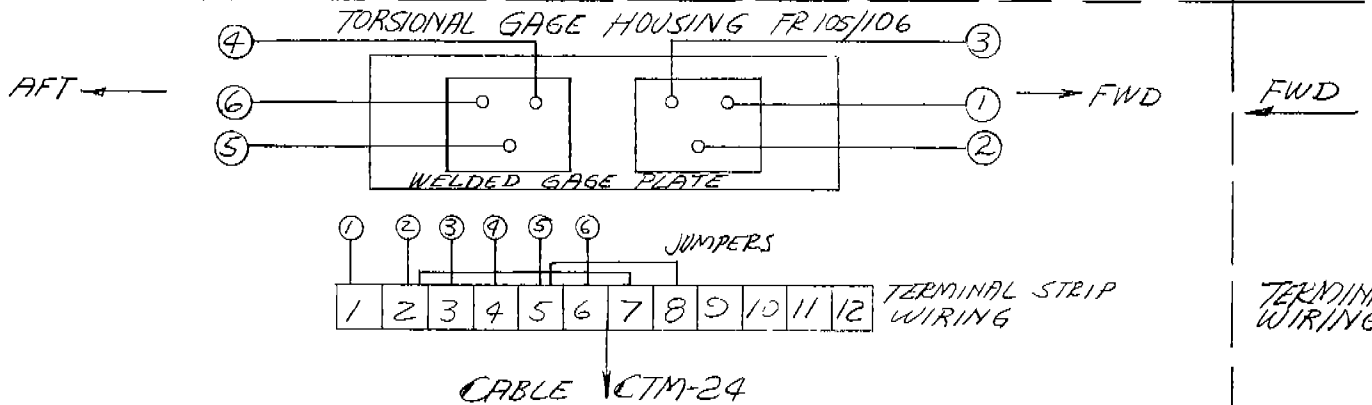

STARBOARD SIDE

SIDE OF SHIP

TOPSIDE DECK HOUSING FR 105/106

WIRES ① - ⑧ WHITE
WIRES ⑨ - ⑫ RED

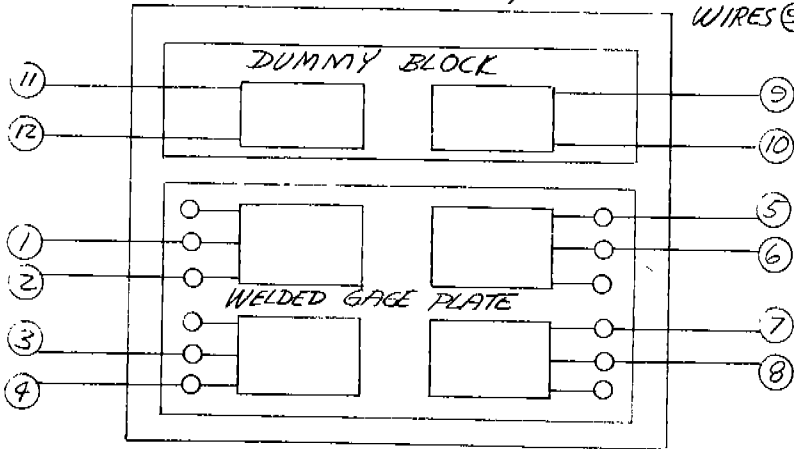

AFT →

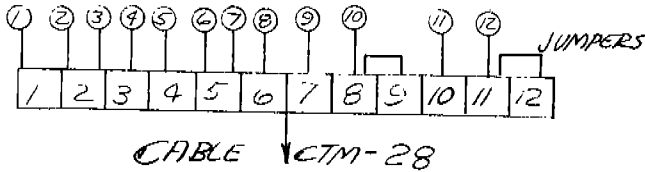

UNDERDECK HOUSING FR 105/106

WIRES ① - ⑧ WHITE
WIRES ⑨ - ⑫ RED

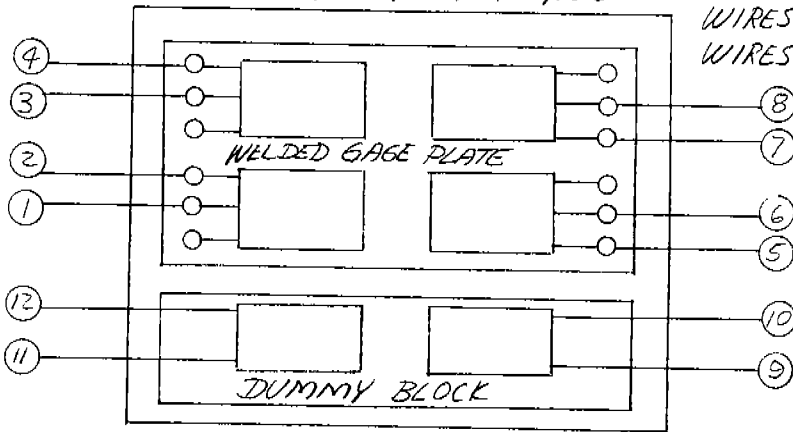

AFT →

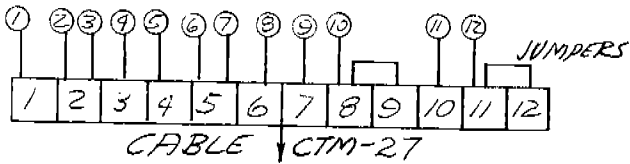

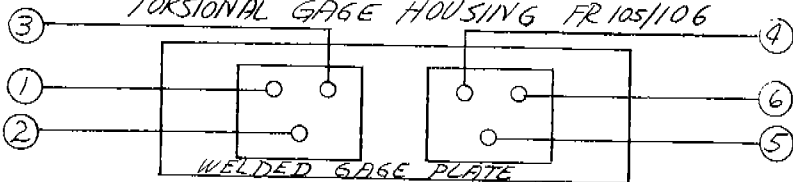

SIDE OF SHIP

TORSIONAL GAGE HOUSING FR 105/106

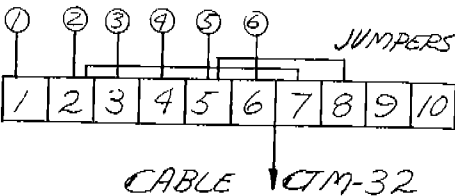

AFT →



| | | | |
|---|------------------------|------------------------|--|
| UNLESS OTHERWISE SPECIFIED DIMENSIONS ARE IN INCHES TOLERANCES ON FRACTIONS DECIMALS ANGLES ± ± ± | DRAFTSMAN LEWIS | DATE 11/2/68 |  TELEDYNE MATERIALS RESEARCH A TELEDYNE COMPANY |
| | CHECKER | | |
| | ENGINEER R. A. FINE | APPROVAL 11/2/68 | |
| | TREATMENT | | |
| FINISH | SCALE | PROJECT NO. 1123.36 | DRAWING NO. D-2750-SH 4 |

NOTE: CABLES #11, #12, #13 CAN ENTER AT EITHER JB 11B OR JB 11A

CONSOLE CABLE #19
8 CONDUCTOR SHIELDED
SEE SHEET 6 FOR REST OF CABLE

CONSOLE CABLE #16
4 CONDUCTOR SHIELDED
SEE SHEET 6 FOR REST OF CABLE

CONSOLE CABLE #12
6 CONDUCTOR SHIELDED

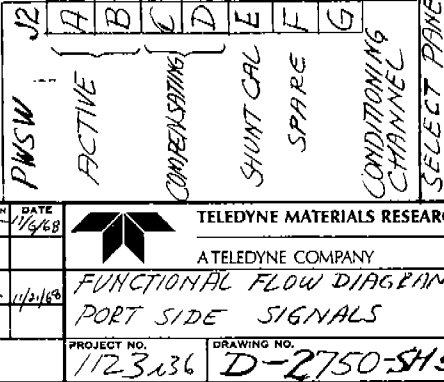
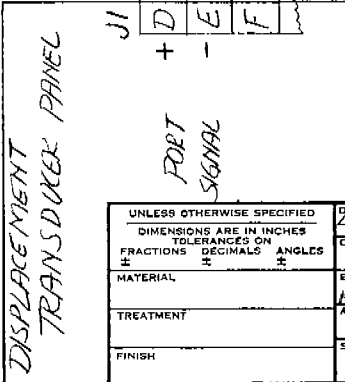
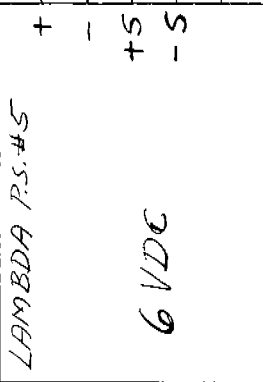

INSTRUMENT ROOM FR 153

CTM-10
MISV-70

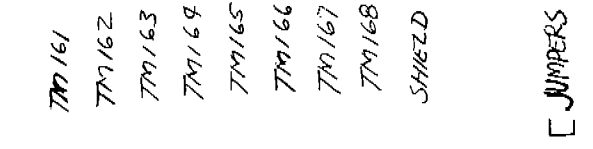
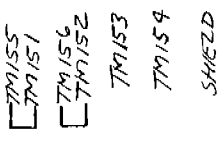
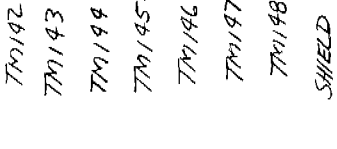

JUMPERS

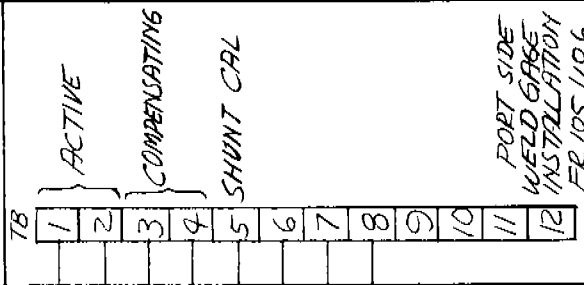
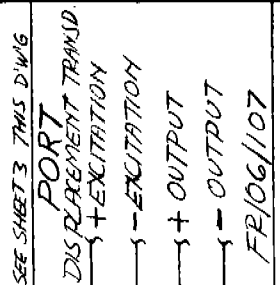
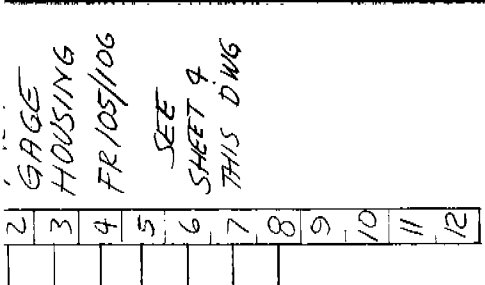

PORT SIDE WELD GAGE INSTALLATION
FR 105/106
SEE SHEET 3 THIS DWG
P.S. W.G.

| | | | | |
|---|-----------|-------------------------|----------------------|---|
| UNLESS OTHERWISE SPECIFIED DIMENSIONS ARE IN INCHES TOLERANCES ON FRACTIONS DECIMALS ANGLES | | DRAFTSMAN LEONE | DATE 11/6/68 | <p>TELEDYNE MATERIALS RESEARCH A TELEDYNE COMPANY</p> |
| MATERIAL | TREATMENT | ENGINEER R.A. YERGEN | APPROVAL 11/21/68 | |
| FINISH | SCALE | PROJECT NO. 1123.236 | | DRAWING NO. D-2750-SH5 |

FUNCTIONAL FLOW DIAGRAM
PORT SIDE SIGNALS

CONSOLE UNIT

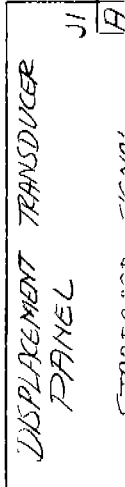
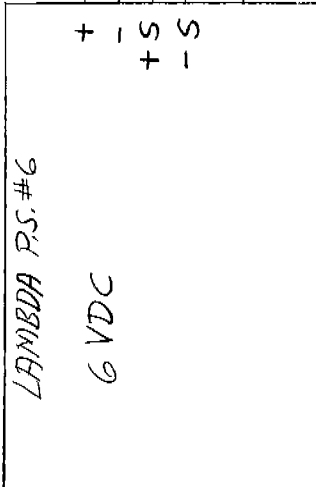

JB CTM-11A

- JUMPERS
TM51-TM31
TM60-TM40
TM52-TM61
TM32-TM111 BOX
TM41-TM102 B
- JUMPERS
TM34-TM54
TM37-TM57
TM55-TM58
- TM35-TM105 BOX
TM38-TM108 B
- TM72-VIA 11B
TM71-TM141
TM73-TM143

SEE SHEET 5
FOR
CABLES 11.1, 11.2 &
11.3 WHICH CARRY
THE THREE BRIDGE
SIGNALS

CONSOLE CABLE #19
8 CONDUCTOR SHIELDED

YELLOW
BLUE
BROWN
ORANGE

SEE SHEETS
FOR REST OF
CABLE

CONSOLE CABLE #16
4 CONDUCTOR SHIELDED

JB CTM-15

- TM 31
- TM 32
- TM 33
- TM 34
- TM 35
- TM 36
- TM 37
- TM 38
- TM 39
- TM 40
- TM 41
- TM 42
- SHIELD

- TM 51
- TM 52
- TM 53
- TM 54
- TM 55
- TM 56
- TM 57
- TM 58
- TM 59
- TM 60
- TM 61
- TM 62
- SHIELD

SEE
TODD
DRAWING
62468-2
SH 4 OF 4

CABLE
CTM-9
MSV-70

CABLE CTM-28
12 CONDUCTOR SHIELDED

- BLACK
- WHITE
- RED
- GREEN
- YELLOW
- BLUE
- BROWN
- ORANGE
- GRAY
- VIOLET
- W/B
- W/R

CABLE CTM-27
12 CONDUCTOR SHIELDED

- BLACK
- WHITE
- RED
- GREEN
- YELLOW
- BLUE
- BROWN
- ORANGE
- GRAY
- VIOLET
- W/B
- W/R

CABLE CTM-32
8 CONDUCTOR SHIELDED

- BLACK
- WHITE
- RED
- GREEN
- YELLOW
- BLUE
- BROWN
- ORANGE

CABLE CTM-30
4 CONDUCTOR SHIELDED

- JUMPERS

STARBOARD
TOPSIDE
TRANSDUCER
HOUSING
FR 105/106

- 1
- 2
- 3
- 4
- 5
- 6
- 7
- 8
- 9
- 10
- 11
- 12

STARBOARD
UNDERDECK
TRANSDUCER
HOUSING
FR 105/106

- 1
- 2
- 3
- 4
- 5
- 6
- 7
- 8
- 9
- 10
- 11
- 12

STARBOARD
TORSION
GAGE
HOUSING
FR 105/106

- 1
- 2
- 3
- 4
- 5
- 6
- 7
- 8
- 9
- 10

STARBOARD
DISPLACEMENT
TRANSDUCER

+ENC FR106/101
 -ENC
 +OUTPUT
 -OUTPUT
 RED
 BLACK
 WHITE
 GREEN
 CABLE CTM-31
 8 CONDUCTOR SHIELDED
 TM 85
 TM 82
 TM 81
 TM 83
 TM 84
 SHIELD

STARBOARD
 SIDE PLATE
 GAGE
 FR 105/106
 SSPG
 SEE
 SHEET 3
 THIS DW'G
 TB
 1
 2
 3
 4
 5
 6
 7
 8
 9
 10
 11
 12
 BLACK
 WHITE
 RED
 GREEN
 YELLOW
 BLUE
 BROWN
 ORANGE
 CABLE CTM-29
 12 CONDUCTOR SHIELDED
 TM 91
 TM 92
 TM 93
 TM 94
 TM 95
 TM 96
 TM 97
 TM 98
 SHIELD

STARBOARD
 UNDER DECK
 GAGE
 (CEMENTED)
 FR 105/106
 SUDG
 SEE
 SHEET 3
 THIS DW'G
 TB
 1
 2
 3
 4
 5
 6
 7
 8
 9
 10
 11
 12
 BLACK
 WHITE
 RED
 GREEN
 YELLOW
 BLUE
 TM 65
 TM 66
 TM 67
 TM 68
 TM 69
 TM 70

STARBOARD
 BOX BEAM
 GAGE
 FR 105/106
 SBBG
 SEE
 SHEET 3
 THIS DW'G
 TB
 1
 2
 3
 4
 5
 6
 7
 8
 BROWN
 ORANGE
 GRAY
 VIOLET
 W/B
 W/R
 TM 45
 TM 46
 TM 47
 TM 48
 TM 49
 TM 50
 SHIELD

STARBOARD TUNNEL
FR 105

TM 84
 WHITE
 SEE SHEET 5
 FOR REST OF
 CABLE

CONSOLE CABLE # 13
 20 CONDUCTOR SHIELDED
 TB
 1
 2
 3
 4
 5
 6
 7
 8
 9
 10
 11
 12
 13
 14
 15
 16
 17
 W/RES 18-20
 NOT TERMINATED
 TM 91
 TM 92
 TM 93
 TM 94
 TM 95
 TM 65
 TM 66
 TM 67
 TM 68
 TM 69
 TM 45
 TM 46
 TM 47
 TM 48
 TM 49
 TM 50
 TM 70
 SHIELD

CONDITIONING CHANNEL
 SELECT PANEL
 J3 P3
 A
 B
 C
 D
 E
 F
 G
 H
 J
 K
 L
 M
 N
 P
 U
 R
 S
 T
 ACTIVE
 COMPENSATING
 SHUNT CAL
 ACTIVE
 COMPENSATING
 SHUNT CAL
 ACTIVE
 COMPENSATING
 SHUNT CAL
 SPARE
 SPARE
 SHIELD
 SSPG
 SUDG
 SBBG

INSTRUMENT ROOM
 FR 193

STARBOARD SIGNAL

| | | | | |
|---|------------|----------------|------------------------|--|
| UNLESS OTHERWISE SPECIFIED DIMENSIONS ARE IN INCHES TOLERANCES ON | | DRAWN LEONE | DATE 11/7/68 |  TELEDYNE MATERIALS RESEARCH A TELEDYNE COMPANY |
| # FRACTIONS | # DECIMALS | CHECKER | ENGINEER R. J. ... | |
| MATERIAL | TREATMENT | SCALE | PROJECT NO. 1123636 | DRAWING NO. D-2750-5H6 |

FUNCTIONAL FLOW DIAGRAM
STARBOARD SIDE SIGNALS

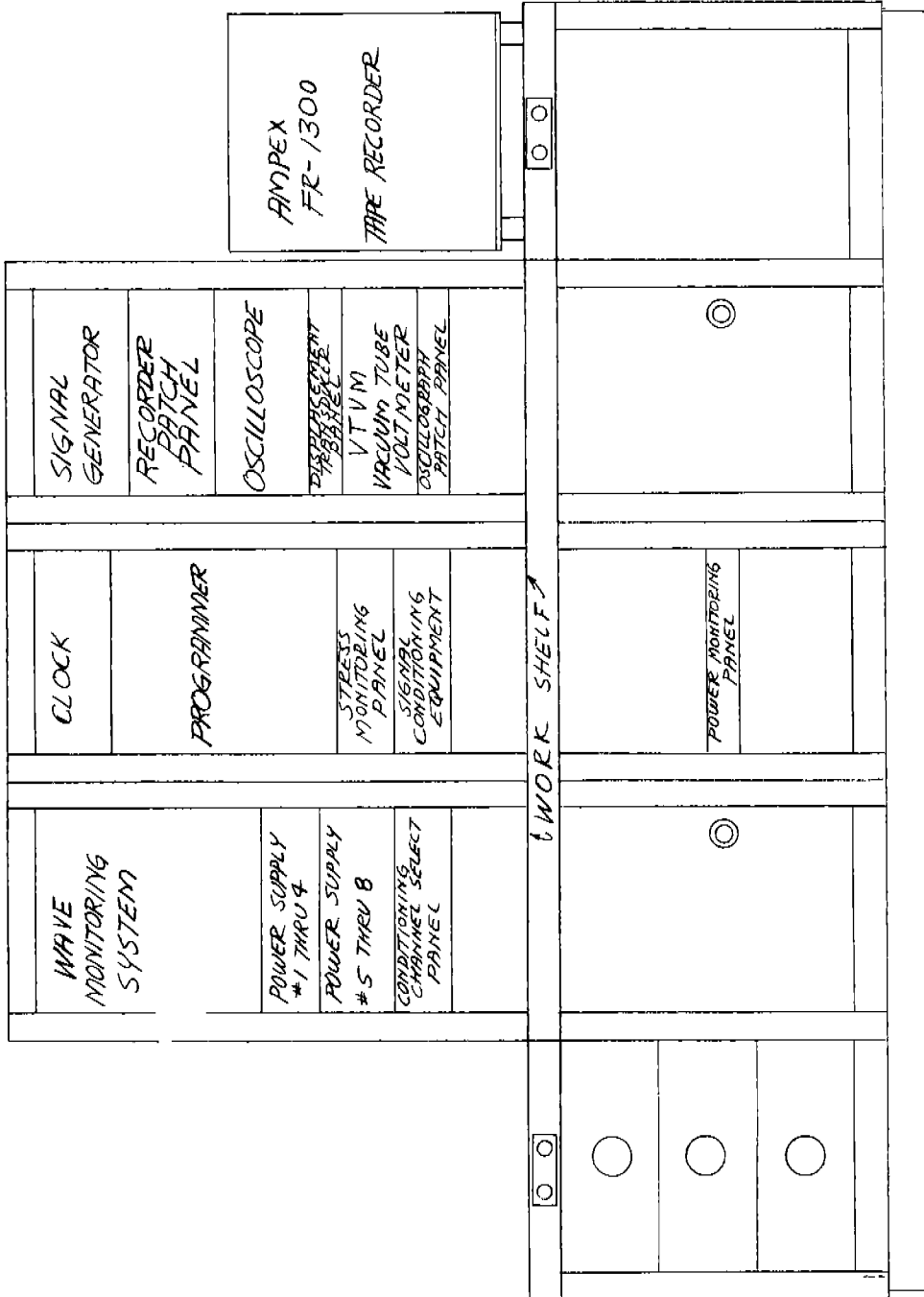

| | | | | | |
|--|-----------|-------------|---------|-----------------------------|--|
| UNLESS OTHERWISE SPECIFIED DIMENSIONS ARE IN INCHES TOLERANCES ON DIMENSIONS | | DRAWING NO. | DATE | TELEDYNE MATERIALS RESEARCH | |
| ± | FRACTIONS | 1123-36 | 11/9/63 | ATELEDYNE COMPANY | |
| ± | DECIMALS | C-2751 | 11/63 | CONTROL CONSOLE ORIENTATION | |
| ± | ANGLES | SH1 | | PANEL LOCATION (FRONT VIEW) | |
| MATERIAL | ENGINEER | PROJECT NO. | SCALE | DRAWING NO. | |
| TREATMENT | APPROVAL | 1123-36 | | C-2751 SH1 | |
| FINISH | | | | | |

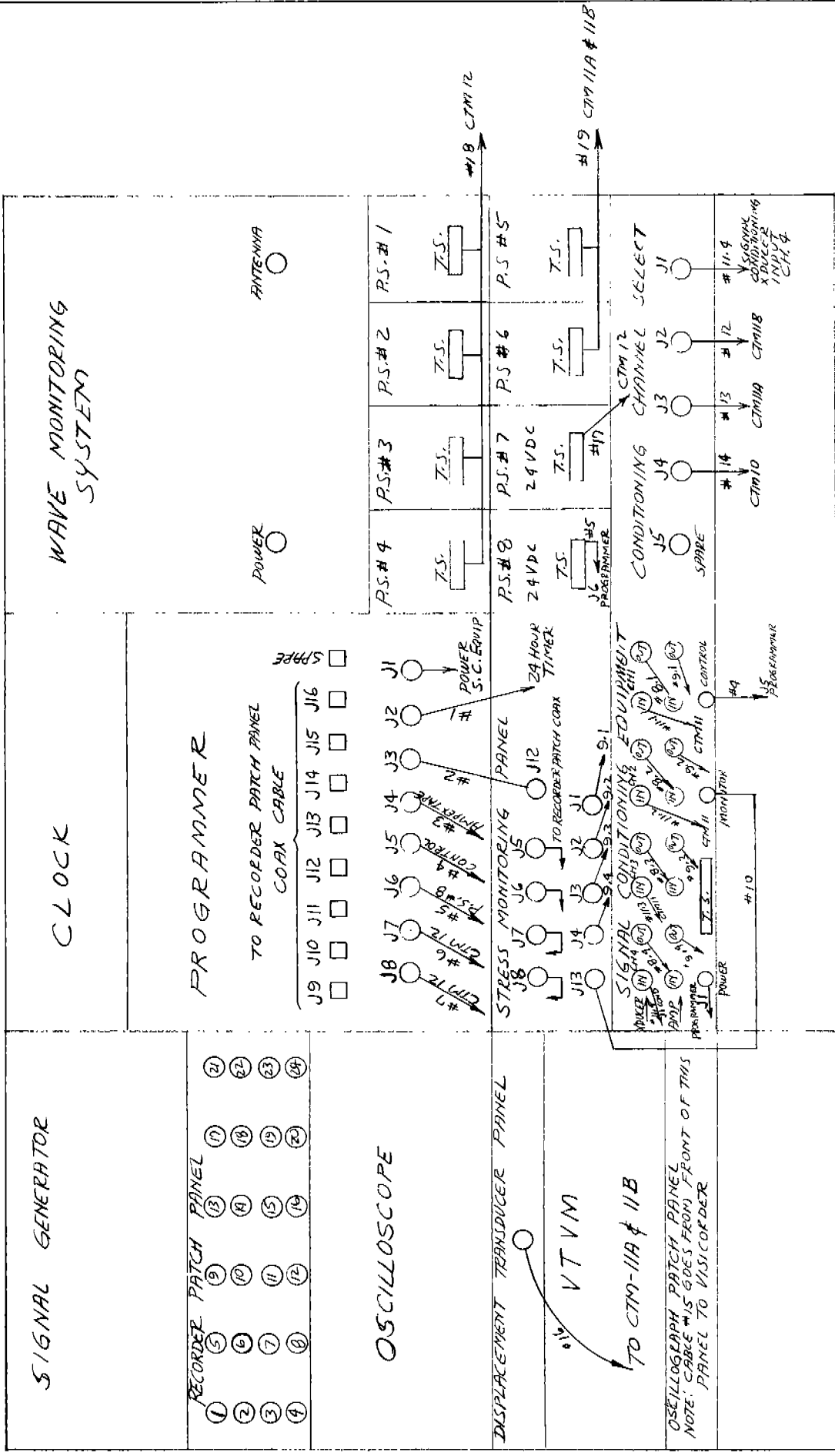

| | | | | | |
|---|--|--------------------------|-------------------------|--|--|
| UNLESS OTHERWISE SPECIFIED DIMENSIONS ARE IN INCHES FRACTIONS DECIMALS ANGLES | | DRAWN BY ZOMBE | DATE 7-2-68 | TELEDYNE MATERIALS RESEARCH ATELEDYNE COMPANY | |
| MATERIAL | | ENGINEER G.A. ELLIOTT | APPROVAL | CONTROL CONSOLE ORIENTATION CONSOLE CABLING (REAR VIEW) | |
| TREATMENT | | SCALE | PROJECT NO. 1123-236 | DRAWING NO. C-27515H2 | |
| FINISH | | | | | |

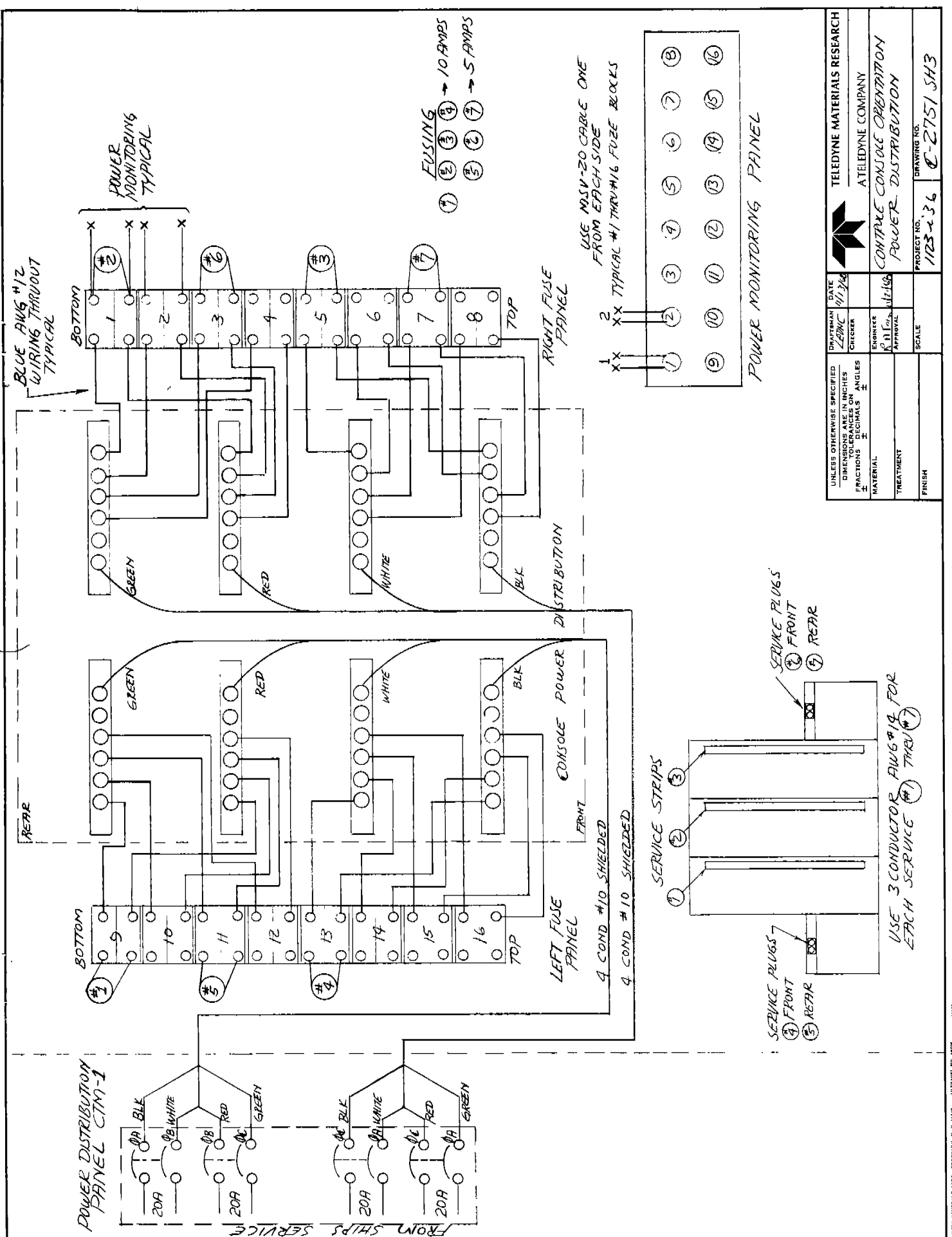

| | | | |
|--|--|-------------|------------|
| UNLESS OTHERWISE SPECIFIED DIMENSIONS ARE IN INCHES FRACTIONS DECIMALS ± | | DATE | 11/2/56 |
| DRAWN BY | | DATE | 11/2/56 |
| CHECKED BY | | ENGINEER | UT/156 |
| MATERIAL | | APPROVAL | |
| TREATMENT | | SCALE | |
| FINISH | | PROJECT NO. | 103-36 |
| | | DRAWING NO. | C-2751 SH3 |

TELEDYNE MATERIALS RESEARCH
A TELEDYNE COMPANY
CONSOLE CONSOLE ORIENTATION
POWER DISTRIBUTION

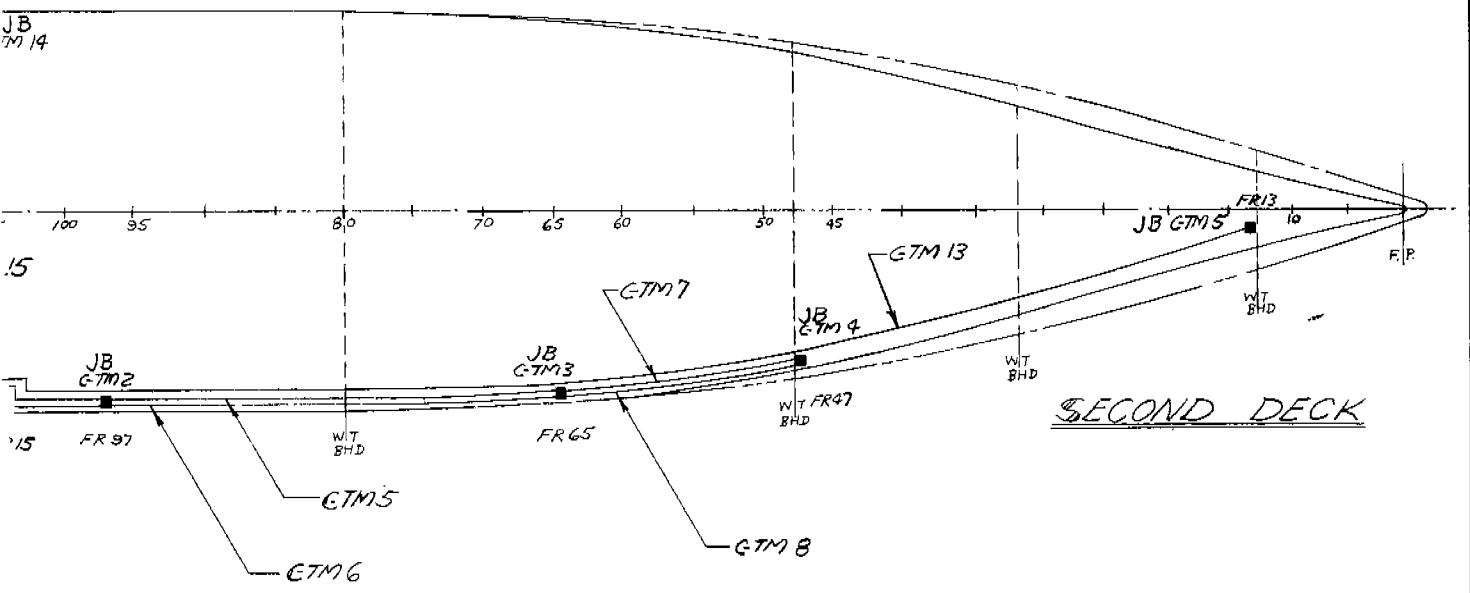
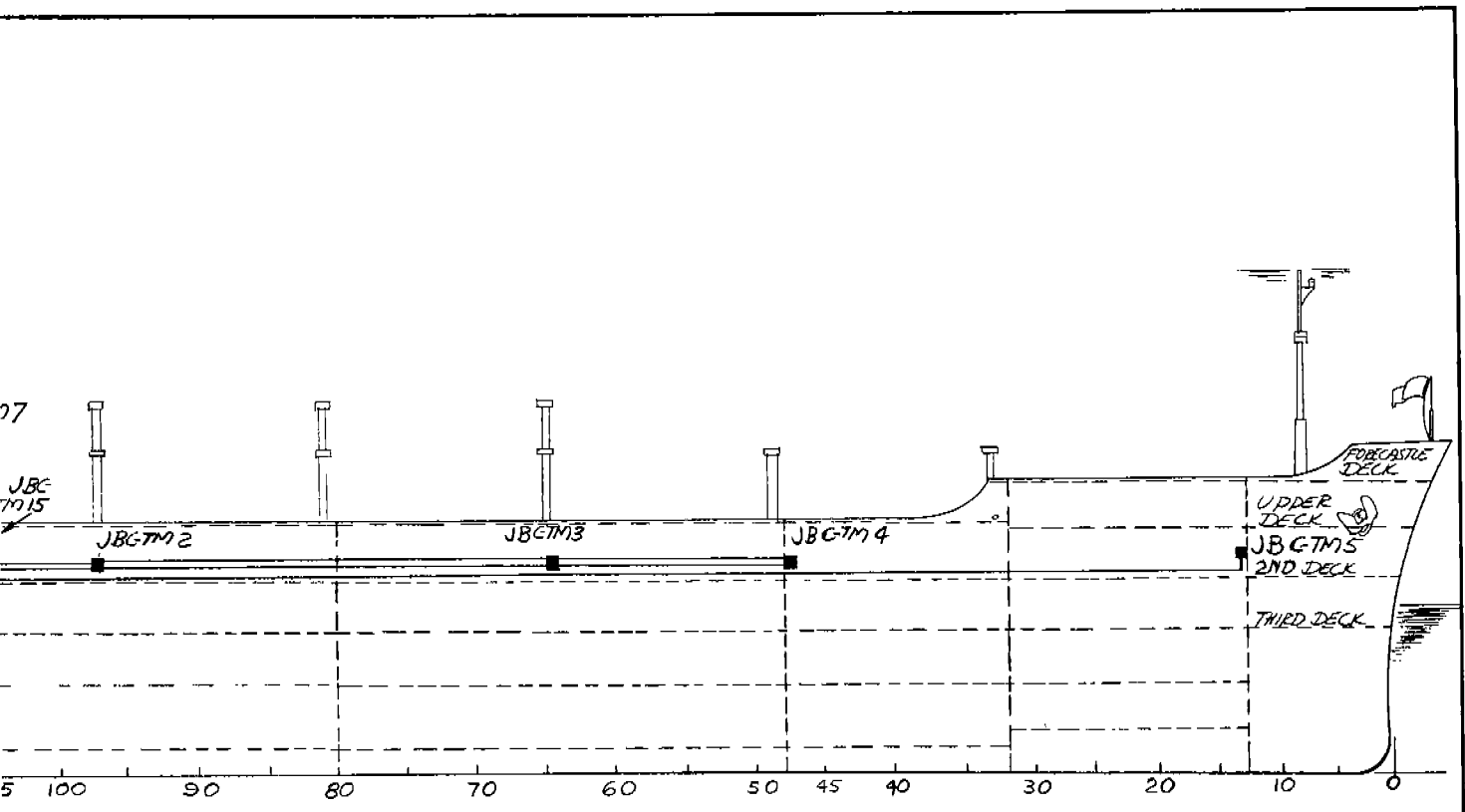

| | | | | | |
|--|----------|---------------------------|-----------------|---|-------------|
| UNLESS OTHERWISE SPECIFIED DIMENSIONS ARE IN INCHES | | DRAFTSMAN <i>LEONE</i> | DATE 7/16/49 | TELEDYNE MATERIALS RESEARCH | |
| TOLERANCES ON | | CHECKER | | A TELEDYNE COMPANY | |
| FRACTIONS | DECIMALS | ENGINEER | | INSTRUMENTATION CABLING AND JUNCTION BOX LAYOUT 55 BOSTON | |
| ± | ± | APPROVAL | | | |
| MATERIAL | | SCALE | | PROJECT NO. | DRAWING NO. |
| TREATMENT | | | | 1123-36 | D-2699A |
| FINISH | | | | | |

Technical Report
E-1123-1

DISTRIBUTION

The distribution of this Progress Report No. 1 is as follows:

| <u>To</u> | <u>Copies</u> |
|--|---------------|
| Commander, Naval Ship Engineering Center Department of the Navy Washington, D.C. 20360 ATTENTION: NAVSEC 6132 | 4 |
| Secretary, Ship Structure Committee 1300 E. Street, N.W. Washington, D.C. | 13 |
| Director, Ship Hull Research Committee National Academy of Sciences 2101 Constitution Avenue, N.W. Washington, D.C. 20418 | 20 |

DOCUMENT CONTROL DATA - R&D

(Security classification of title, body of abstract and indexing annotation must be entered when the overall report is classified)

| | | | |
|---|--|--|-------------------------|
| 1. ORIGINATING ACTIVITY <i>(Corporate author)</i> Teledyne Materials Research 303 Bear Hill Road Waltham, Massachusetts 02154 | | 2a. REPORT SECURITY CLASSIFICATION Unclassified | |
| | | 2b. GROUP | |
| 3. REPORT TITLE DESIGN AND INSTALLATION OF A SHIP RESPONSE INSTRUMENTATION SYSTEM ABOARD THE CONTAINER VESSEL S.S. BOSTON | | | |
| 4. DESCRIPTIVE NOTES <i>(Type of report and inclusive dates)</i> PROGRESS REPORT NO. 1 - 1 July 1968 to 1 December 1968 | | | |
| 5. AUTHOR(S) <i>(Last name, first name, initial)</i> R.A. Fain, J.Q. Cragin, and B.H. Schofield | | | |
| 6. REPORT DATE 13 December 1968 | | 7a. TOTAL NO. OF PAGES 14 | 7b. NO. OF REFS None |
| 8a. CONTRACT OR GRANT NO. N00024-68-C-5486 | | 9a. ORIGINATOR'S REPORT NUMBER(S) E-1123-1 | |
| b. PROJECT NO. F-35422306 | | | |
| c. Task 2022, SR 182 | | 9b. OTHER REPORT NO(S) <i>(Any other numbers that may be assigned this report)</i> None | |
| 10. AVAILABILITY/LIMITATION NOTICES For the initial distribution, this report will be available only to those specifically required by the contract. | | | |
| 11. SUPPLEMENTARY NOTES None | | 12. SPONSORING MILITARY ACTIVITY U.S. Navy, Naval Ship Systems Command | |
| 13. ABSTRACT SUMMARY Progress during this reporting period consisted of design, procurement, and installation of a ship response instrumentation system aboard the con- tainer vessel S.S. BOSTON. Included in this report are the following: a detailed description of the system, consisting of the parameters to be measured; the type and location of the transducers installed; components and functional operation of the data acquisition and recording system; data analysis procedures; and equipment specifications. In addition, a description of the procedure and the results of the first transducer calibration attempt are presented. | | | |