

SSC-224

**FEASIBILITY STUDY
OF
GLASS REINFORCED PLASTIC CARGO SHIP**

**This document has been approved
for public release and sale; its
distribution is unlimited.**

SHIP STRUCTURE COMMITTEE

1971

SHIP STRUCTURE COMMITTEE

AN INTERAGENCY ADVISORY
COMMITTEE DEDICATED TO IMPROVING
THE STRUCTURE OF SHIPS

MEMBER AGENCIES:

UNITED STATES COAST GUARD
NAVAL SHIP SYSTEMS COMMAND
MILITARY SEALIFT COMMAND
MARITIME ADMINISTRATION
AMERICAN BUREAU OF SHIPPING

ADDRESS CORRESPONDENCE TO:

SECRETARY
SHIP STRUCTURE COMMITTEE
U.S. COAST GUARD HEADQUARTERS
WASHINGTON, D.C. 20590

SR 195
1971

The Ship Structure Committee is sponsoring research to investigate the suitability of modern structural materials for ships' hull structures and to examine changes in design practices necessary to take advantage of the properties of these materials.

This report describes an investigation undertaken to evaluate the technical and economic feasibility of constructing a large cargo ship of glass reinforced plastic (GRP). The possibility of using this material for hull components is also discussed.

Comments on this report are solicited.



W. F. REA, III
Rear Admiral, U.S. Coast Guard
Chairman, Ship Structure Committee

SSC-224
Final Technical Report
on
Project SR-195 "Reinforced Plastic Ships"

FEASIBILITY STUDY
OF
GLASS REINFORCED PLASTIC CARGO SHIP

by
Robert J. Scott
John H. Sommella
Gibbs & Cox

under
Department of the Navy
Naval Ship Engineering Center
Contract No. N00024-70-C-5374

*This document has been approved
for public release and sale;
its distribution is unlimited.*

U.S. Coast Guard Headquarters
Washington, D.C.
1971

ABSTRACT

This study was undertaken to evaluate the technical and economic feasibility of constructing and operating a large glass reinforced plastic (GRP) cargo vessel or, alternatively, using GRP for major structural components on a steel cargo ship.

The design and fabrication of a large GRP cargo ship is shown to be totally within the present state-of-the-art, but the long term durability of the structure is questionable. Additional research is required to establish satisfactory confidence in material properties. Experience with existing large GRP vessels is reviewed and extrapolated, where possible, to the large GRP cargo ship. Criteria for the design of the GRP hull structure are presented and **justified**. Methods of system/equipment installation are reviewed.

GRP ship structures are unacceptable under present U.S. Coast Guard fire regulations requiring the use of incombustible materials.

The design of a large GRP cargo vessel utilizing a composite unidirectional-woven roving laminate is presented and compared to the equivalent steel ship. The saving in the structural weight of the GRP ship is 40 per cent. The hull is five times as flexible as the steel hull.

Cost studies indicate that, for the same return on investment, the Required Freight Rate of the GRP cargo ship is higher than that of the equivalent steel ship for all levels of procurement, hull life and for various laminate layup rates considered. Similar studies of container ships and bulk carriers arrive at similar conclusions. However, major structural components such as deckhouses, hatch covers, king posts and bow modules are shown to be economically justified in some cases.

Areas for further research are presented, and further investigations of smaller GRP vessels (150-250 feet long) are proposed since these appear most promising at this time.

CONTENTS

	<u>PAGE</u>
I. INTRODUCTION	1
Background	1
Scope of Study	4
Limitations	4
Selection of Cargo Ship	6
II. MATERIAL AND DESIGN STUDIES	9
A. REVIEW OF GRP MATERIALS	9
Resins	9
Reinforcements	12
Core Materials	14
Physical Properties - Static	15
Physical Properties - Fatigue	19
Creep	20
Impact Strength	20
Buckling Strength	20
Secondary Bond	20
Resistance to Environment and Aging	22
Abrasion Resistance	24
Material Costs	24
Selection of GRP Materials	25
B. STRUCTURAL CONCEPTS	26
Single Skin Vs. Sandwich	26
Longitudinal Vs. Transverse Framing	26
C. OPERATIONAL EXPERIENCE WITH EXISTING GRP VESSELS	27
General Observations	27
Resistance to Environment	27
Abrasion and Impact	27
Repairs	28
Maintenance	29
D. FABRICATION FACILITIES AND PROCEDURES	29
Facility Requirements	29
Proposed Hull Fabrication Procedure	30
Quality Control and Inspection	32
E. FIRE RESISTANCE	33
F. INSTALLATION OF SYSTEMS AND EQUIPMENT	35
Materials	35
Attachment of Equipment	35
Piping	35

CONTENTS (Cont'd)

	<u>PAGE</u>
II. G. OPERATIONAL CHARACTERISTICS OF A GRP CARGO SHIP	36
Maintenance	36
Repairs	36
Special Surveys	37
Hull Insurance	37
H. SUMMARY	37
III. DESIGN CRITERIA	39
Existing Criteria	39
Proposed Criteria - Midship Section Hull Girder Section . .	39
Modulus	39
Proposed Criteria - Primary Hull Structure	43
Design Criteria for Plates	43
Design Criteria for Stiffeners	45
Alternate Design Criteria	45
IV. DESIGN OF GRP CARGO SHIP	47
Selection of Principal Dimensions	47
Design of GRP Midship Section	47
Hull Girder Deflection	51
Light Ship Weight Estimate	53
Trim and Stability	56
V. COST STUDIES	58
Objectives	58
Construction Cost Estimates	58
Life Cycle Economic Studies	67
Sensitivity Studies	71
VI. ALTERNATIVE TYPES OF LARGE GRP SHIPS	79
Container Ship	79
Bulk Carrier	84
Other Types of GRP Vessels	86
VII. INVESTIGATION OF LARGE GRP STRUCTURAL COMPONENTS	88
Approach	88
Deckhouse	89
Cargo King Post	94
Hatch Covers	95
Other Components	98
Summary	101
VIII. RECOMMENDED AREAS FOR FURTHER STUDY	103
General Considerations	103
GRP Structural Components	104
Costs	104

CONTENTS (Cont'd)

	<u>PAGE</u>
Materials	106
Fire Resistance	107
Design Criteria	107
Deflections	108
Fabrication Procedures	109
Quality Control and Inspection	109
Maintenance and Repair Costs	110
Structural Details	110
IX. CONCLUSIONS AND RECOMMENDATIONS	112
Conclusions	112
Recommendations	115
LIST OF REFERENCES	116
<u>APPENDIX</u>	
A. DETERMINATION OF MAXIMUM ACQUISITION COST OF GRP COMPONENTS FOR EQUIVALENT LIFE CYCLE COST WITH STEEL COMPONENT	119
Basic Assumptions for Study	119
Procedure	119
Results	119

LIST OF FIGURES

<u>FIGURE NO.</u>		<u>PAGE</u>
1.	General Arrangement - <i>S.S. JAMES LYKES</i>	7
2.	Midship Section - <i>S.S. JAMES LYKES</i>	8
3.	S-W Curves of Steel and GRP Laminates	19
4.	Proposed Hull Molding and Layup Procedure	31
5.	Midship Section - Composite Laminate GRP Construction	50
6.	Construction Cost Estimates - Steel and GRP Cargo Vessels	65
7.	Required Freight Rate - Steel and GRP Cargo Vessels - . 20 Year Life	73
8.	Required Freight Rate - Steel and GRP Cargo Vessels - . 30 Year Life	73
9.	General Arrangement - Container Ship	80
10.	General Arrangement - Bulk Carrier <i>MV CHALLENGER</i>	85
11.	Allowable Increase in Acquisition Cost of GRP Components	90
12.	Cross Section Through Typical Steel and GRP Hatch Covers	96
13.	Possible GRP Bow Module	101

LIST OF TABLES

<u>TABLE NO.</u>		<u>PAGE</u>
1.	Principal Characteristics - <i>S.S. JAMES LYKES</i>	6
2.	Physical Properties of Typical Marine GRP Laminates	16
3.	Average Physical Properties - Unidirectional GRP Laminates	17
4.	Approximate Physical Properties of Woven Roving - Unidirectional Composite Laminate	18
5.	Average Physical Properties - Core Materials	18
6.	Chemical Resistance of Typical GRP Resins	23
7.	GRP Material Cost	24
8.	Safety Factor Coefficients - GRP Laminates	42
9.	Coefficients for Determining GRP Plate Thickness	44
10.	Design Loads and Safety Factors - GRP Hull Structure	46
11.	Comparison of Steel and GRP Midship Sections	51
12.	Light Ship Weight Estimate - Steel Construction	53
13.	Weight Reduction Coefficients - Hull Structure	54
14.	Weight Reduction Coefficients - Outfit	55
15.	Light Ship Weight Estimate - Composite GRP Construction	55
16.	Trim and Stability - Full Load Departure Condition	56
17.	Trim and Stability - 1/2 Consumables, 1/2 Cargo	57
18.	Estimated Cost of Steel Cargo Ship	58
19.	Estimated Costs of GRP Midship Section Structure	61
20.	Hull Structure Costs for Each of Five GRP Ships	62
21.	Construction Cost Estimate Summary - Steel Cargo Vessel - 20 Year Life	63

LIST OF TABLES (Cont'd)

<u>TABLE NO.</u>		<u>PAGE</u>
22.	Construction Cost Estimate Summary - GRP Cargo Vessel	64
23.	Summary of Life Cycle Costs for Steel and GRP Cargo Ship	72
24.	Summary of Sensitivity Studies A through E	76-77
25.	Summary of Sensitivity Study F - Fire-Retardant Resins	78
26.	Summary of Sensitivity Study G - Deadweight Utilization	78
27.	Principal Characteristics - Steel Container Ship	79
28.	Light Ship Weight Estimates - Steel and GRP Container Ships	81
29.	Construction Cost - Steel and GRP Container Ships	81
30.	Summary of Life Cycle Costs for Steel and GRP Container Ship	83
31.	Principal Characteristics - Bulk Carrier <i>MV CHALLENGER</i>	84
32.	Light Ship Weight Estimates - Steel, Aluminum and GRP Bulk Carriers	84
33.	Construction Cost - Steel, Aluminum and GRP Bulk Carriers	86
34.	Scantlings - GRP and Steel Deckhouses	92
35.	Weight Comparison - GRP and Steel Deckhouses	93
36.	Construction Cost Comparison - GRP and Steel Deckhouses	93
37.	Scantlings - GRP and Steel King Posts	95
A-1	Allowable Increase in Acquisition Cost of GRP Components	120

SHIP STRUCTURE COMMITTEE

The SHIP STRUCTURE COMMITTEE is constituted to prosecute a research program to improve the hull structures of ships by an extension of knowledge pertaining to design, materials and methods of fabrication.

RADM W. F. Rea, III, USCG, Chairman
Chief, Office of Merchant Marine Safety
U. S. Coast Guard Headquarters

Capt. J. E. Rasmussen, USN
Naval Ship Engineering Center
Prince George's Center

Mr. E. S. Dillon
Chief
Office of Ship Construction
Maritime Administration

Capt. T. J. Banvard, USN
Maintenance and Repair Officer
Military Sealift Command

Mr. K. Morland, Vice President
American Bureau of Shipping

SHIP STRUCTURE SUBCOMMITTEE

The SHIP STRUCTURE SUBCOMMITTEE acts for the Ship Structure Committee on technical matters by providing technical coordination for the determination of goals and objectives of the program, and by evaluating and interpreting the results in terms of ship structural design, construction and operation.

NAVAL SHIP ENGINEERING CENTER

Mr. P. M. Palermo - Chairman
Mr. J. B. O'Brien - Contract Administrator
Mr. G. Sorkin - Member
Mr. H. S. Sayre - Alternate
Mr. I. Fioriti - Alternate

MARITIME ADMINISTRATION

Mr. F. Dashnaw - Member
Mr. A. Maillar - Member
Mr. R. Falls - Alternate
Mr. R. F. Coombs - Alternate

AMERICAN BUREAU OF SHIPPING

Mr. S. G. Stiansen - Member
Mr. F. J. Crum - Member

OFFICE OF NAVAL RESEARCH

Mr. J. M. Crowley - Member
Dr. W. G. Rauch - Alternate

NAVAL SHIP RESEARCH & DEVELOPMENT CENTER

Mr. A. B. Stavovy - Alternate

MILITARY SEALIFT COMMAND

Mr. R. R. Askren - Member
LT. JG. E. T. Powers, USNR - Member

U. S. COAST GUARD

LCDR C. S. Loosmore, USCG - Secretary
CDR C. R. Thompson, USCG - Member
CDR J. W. Kime, USCG - Alternate
CDR J. L. Coburn, USCG - Alternate

NATIONAL ACADEMY OF SCIENCES

Mr. R. W. Rumke, Liaison
Prof. R. A. Yagle, Liaison

SOCIETY OF NAVAL ARCHITECTS & MARINE ENGINEERS

Mr. T. M. Buermann, Liaison

BRITISH NAVY STAFF

Dr. V. Flint, Liaison
CDR P. H. H. Ablett, RCNC, Liaison

WELDING RESEARCH COUNCIL

Mr. K. H. Koopman, Liaison
Mr. C. Larson, Liaison

I. INTRODUCTION

This report summarizes the results of a technical and economic feasibility study for designing, building and operating a large glass reinforced plastic (GRP) cargo vessel, and of utilizing large GRP structural components.

BACKGROUND

Glass reinforced plastics as a marine structural material were first introduced just after the end of World War II. A series of 28 foot GRP personnel boats were manufactured for the U.S. Navy. Since that time, both the quantity and size of GRP boats has increased significantly, the major growth being in the pleasure boat industry. In recent years, the advantages of GRP have been recognized for some commercial type vessels, resulting in the construction of GRP shrimp trawlers and fishing vessels up to 93 feet in length, References (1) through (5). Recent studies have demonstrated the technical and economic feasibility of building fishing trawlers of up to 110 feet in length (Reference (6)). It is generally accepted, that there are no technical restraints for building GRP vessels approximately 200 feet in length within the present state-of-the-art.

Since the introduction of GRP the U.S. Navy has been actively engaged in advancing the state-of-the-art for application to naval craft and is responsible for numerous advances in its technology and development. Recent U.S. Navy feasibility studies on GRP minesweepers to 189 feet in length, summarized in Reference (7), have resulted in the construction and testing of a full scale midship section of a GRP minesweeper. In Great Britain, parallel studies have advanced from the evaluation of tests on a midship section to the production of a prototype GRP minehunter. When this 153 foot minehunter is completed in the near future, it will be the largest GRP vessel ever fabricated.

The advantages of using GRP in lieu of other materials for the construction of vessels have been elaborated extensively in the literature. Briefly, they are as follows:

- o Resistance to the Marine Environment. GRP does not corrode, rot or otherwise deteriorate when exposed for extended periods to salt air or water.
- o Light Weight. With proper design and control in the shop, GRP structures can be fabricated which are about one-half the weight of equivalent steel or wood structures, and about equal in weight to equivalent aluminum structures.
- o High Strength. The inherent strength of GRP is quite high relative to its weight, and long exposure to salt water has little effect on its properties.

- o Seamless Construction. GRP hulls are generally fabricated as a one-piece molding, without seams or laps.
- o Chemically Inert. GRP does not react to salt water or most chemical cargoes, and is not susceptible to electrolysis.
- o Ability to Orient Fiber Strength. The nature of GRP reinforcement permits the glass fibers to be oriented in the direction of maximum stress, thus providing the designer with the ability to economically optimize strength-weight relationships to a greater extent than with metals.
- o Ability to Mold Complex Shapes. GRP materials can be molded into a wide variety of complex shapes with relative ease and economy. This provides design flexibility and the ability to easily comply with optimum form requirements.
- o Flexibility. The low modulus of elasticity of GRP is beneficial in absorbing energy from impact loads, such as slamming. However, this flexibility can also be a design constraint.
- o Competitive Cost. Although the cost of GRP materials is usually considerably higher than wood or steel, the over-all cost of a GRP boat is usually only slightly higher than the equivalent wood or steel hull providing the number of hulls being built in GRP are sufficient to amortize the cost of molds and other tooling. Higher costs are to be expected for prototype or one of a kind GRP hulls. GRP is generally competitive with, or slightly cheaper than, aluminum construction for high-volume production.
- o Low Maintenance. The non-corrosive nature of GRP generally results in much lower hull maintenance for smaller craft. The corresponding savings for larger hulls may be less, since antifouling painting is required at the same intervals as with steel hulls, and painting of topsides will eventually be required to cover up scrapes, gouges and color fading even if the gel coat is originally pigmented.
- o Long Life. Recent surveys of U.S. Navy small boats, Reference (8), indicate no degradation in laminate properties after as long as 15 years service. This conclusion can probably be extrapolated to 20 years which is the usual vessel life. Longer hull life may well be possible, though substantiating data is presently unavailable.

These advantages are offset by a number of potential problems associated with GRP when larger hulls are being considered, including the following:

- o Hull Stiffness. The modulus of elasticity of GRP laminates incorporating unidirectional rovings does not exceed $2-1/2$ to 4×10^9 PSI, compared to 30×10^9 PSI for steel. Thus, for equivalent thickness, a GRP hull would deflect about 10 to 12 times as much as a steel hull. For equivalent weight, the deflection of a GRP hull would be about $2-1/2$ to 3 times that of a steel hull. Although there are presently no firm guidelines on allowable deflection of oceangoing freighters, it is obvious that excessive hull deflections could cause binding and damage to the propulsion shafting, as well as damage to longitudinally-oriented piping.

- o Hull Strength. Although the basic short term strength of GRP is quite satisfactory, its fatigue strength is generally low, which must be considered in selecting design loads and safety factors. In addition, large GRP structures must be evaluated to determine the problems associated with stress concentrations such as at hatch corners, endings of stiffeners or decks, and other discontinuities. The low buckling strength of GRP also warrants consideration in evaluating basic structural concepts.
- o Creep. GRP has a tendency to creep if subjected to long-term loading and if the laminate stresses are high. This indicates the need to minimize still water bending moment, and may significantly affect loading conditions.
- o Vibration. The low modulus of elasticity of GRP could lead to problems with hull girder natural frequencies and potential resonance with wave-induced forcing functions on the propulsion system components.
- o Abrasion. The abrasion resistance of GRP is generally not satisfactory for the type of cargo handling and shifting associated with a break-bulk cargo ship, which must be considered in selecting materials for cargo decks.
- o Fuel Tanks. The tendency of fuel oil to soak into flaws and into laminates laid up with coarse fabric reinforcements such as woven roving will require special attention in configuring fuel oil tanks. For limited fuel capacity, separately molded non-integral tanks are generally used. However, for a cargo vessel, the large fuel capacity required would make separate tanks unattractive both from a cost and weight point of view.
- o Quality Control. The key to successful quality control at this time is visual inspection of laminates and destructive testing, though non-destructive methods such as ultrasonics are currently under development. For the proposed cargo ship application, both visual inspection and destructive testing may be impracticable, indicating a requirement for development and use of non-destructive means of assuring quality.
- o Layup. The fabrication of a large cargo ship hull of GRP will necessitate a complete re-evaluation of layup methods and assembly of components. The traditional hand layup techniques must be augmented by mechanized impregnation, distribution and compacting of the fiber-glass reinforcement. The current laminating resins must be cured at temperatures of 50 degrees F or better, indicating the need for a very large enclosed area with proper temperature control. The large quantities of resin required may be an incentive for the chemical industry to develop new low-temperature and slow curing resins suitable to this application.
- o Assembly. The massiveness of the layups being considered for a cargo ship hull indicates the need for an extensive evaluation of structural module size. For example, in lieu of a one-piece shell, it may be more economical to divide the hull into a number of large sub-assemblies.

- o Secondary Bonds. The secondary bonding of two precured GRP parts is perhaps the weakest part of the technology today. The reliability of such joints is questionable since there are no proven, consistently optimum methods of accomplishing these types of joints and their long-term behavior is unknown. This is an area requiring intensive and immediate investigation.
- o Vulnerability to Fire. GRP laminates laid up with general purpose resin will support combustion, and rapidly lose strength. This indicates the need for consideration of fire-retardant resins or other protective methods.
- o Installation of Systems. The attachment of equipment, pipes, cableways and miscellaneous outfit items to the GRP hull structure is in general more difficult than with steel construction. This may require sophisticated details which could be reflected in higher construction cost.

SCOPE OF STUDY

This program consisted of seven phases:

- o Material and design studies including a review of GRP material properties, operational experience, fabrication concepts, fire protection, and system and equipment installation.
- o Development of design criteria for the GRP hull girder and principal structural components.
- o Design of the GRP cargo ship, including structural studies, weight and stability studies and analysis of hull girder deflections.
- o Cost studies, wherein equivalent steel and GRP cargo ships are analyzed to determine required freight rates for various levels of procurement and vessel life of from 20 to 30 years, as well as sensitivity studies of the effects of varying design assumptions.
- o Investigation of alternative ship types, including containerships, bulk carriers and tankers.
- o Investigation of large GRP structural components as an alternative to an all-GRP hull.
- o Recommended areas for further study, wherein a research program is proposed for extending this study into areas requiring further investigation, including assessment of the benefits from and probabilities of, achieving a solution to the stated problems.

LIMITATIONS

Prior to undertaking this study, the following basic limitations were established:

- o The GRP hull structure will be fabricated with state-of-the-art materials and processes since the study is intended to develop

a design suitable for construction in the immediate future. Thus, major technical advances in materials are not considered applicable to this study. The large size of the hull might dictate the use of heavier reinforcements such as 40 ounce per square yard woven roving versus the conventional 24 ounce material, but these should not have a major effect on total construction costs. More sophisticated state-of-the-art materials and construction methods, such as filament winding, graphite or carbon composites, etc. were not considered.

- o Major advances in fabrication procedures were not considered for this study for several reasons. First, procurement of these ships in the next few years precludes the development of a major breakthrough in fabrication of large GRP structures. Such a breakthrough will undoubtedly involve a significant R&D effort, requiring a great deal of time and money. It is unlikely that such a development, when it is forthcoming, will be tried initially on such a large hull, due to the risks involved. Therefore, it has been assumed that labor productivity will correspond to present hand-layup technology, with such automation as can be economically justified. It is apparent that some improvements in layup techniques must be utilized if the present small-boat labor utilization is to be realized. For example, mechanized lay-down of preimpregnated reinforcement, ultraviolet cure systems, etc. must be considered, which are within the present state-of-the-art.
- o All economic studies are based upon the assumption that the level of technology and available facilities and skills are equivalent to those presently available for building the equivalent steel ship. This implies that one or more GRP ships of equal size and complexity have been built prior to the ship or ships under consideration. This study specifically excludes detail consideration of the economics of the prototype large GRP hull, and thus does not consider the following:

Cost of building and outfitting the shipyard required to fabricate large GRP hulls or, alternatively, the cost of modifying an existing shipyard to perform this function.

Research and development for improving materials, production techniques, inspection, etc.

Development of general equipment and tooling for GRP not intended for a specific ship or class of ships, such as pre-impregnating equipment, resin distribution systems, test equipment, etc.

Initial training required to develop a large staff of capable laminators, line foremen, supervisors, engineers, etc. knowledgeable in GRP production and technology.

Start-up problems associated with the design and construction of a prototype.



It is necessary to make these limitations in order to compare the economics of GRP and steel vessels on an equal basis. It is difficult to assess the effects of the above factors on the economics of a GRP cargo ship. However, experience with U.S.-built GRP fishing vessels in the 70-80 foot length range indicates that the direct cost of a prototype trawler will be from 5 to 7 times that of a production vessel, exclusive of plant construction costs.

SELECTION OF CARGO SHIP

The baseline ship should preferably have the machinery located relatively far aft, to minimize the effects of hull girder deflection on shafting, and relatively small cargo hatches to minimize problems with excessive laminate thickness and flexibility. The vessel selected for this study is the SS JAMES LYKES, Lykes Bros. Steamship Co., Inc. which has the characteristics shown in Table 1. The general arrangements and midship section are shown in Figures 1, 2 respectively.

TABLE 1

PRINCIPAL CHARACTERISTICS - SS JAMES LYKES

Type:	Dry/Bulk Cargo, 5 Holds
MarAd Designation:	C3-S-37a
Length Between Perpendiculars	470' 0"
Beam	69' 0"
Depth	41' 7"
Draft (Scantling)	30' 0"
Builder	The Ingalls Shipbuilding Corporation
Classification	ABS  A1 

This vessel is representative of a broad spectrum of medium-to-large dry cargo vessels being built today and is sufficiently well documented to produce a high level of confidence in the physical characteristics of the baseline design.

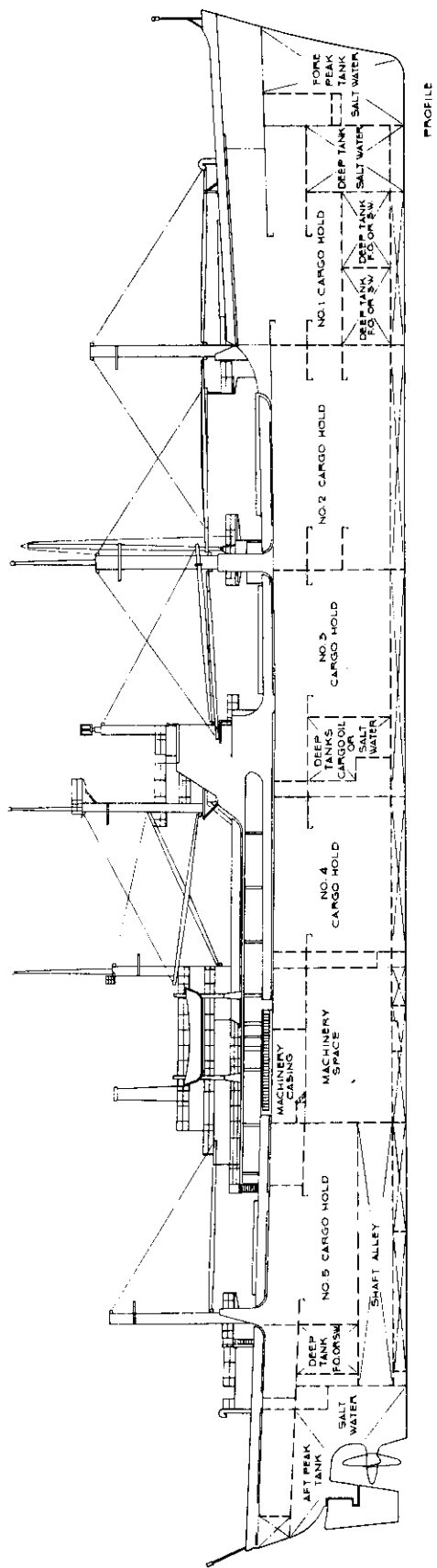

PROFILE

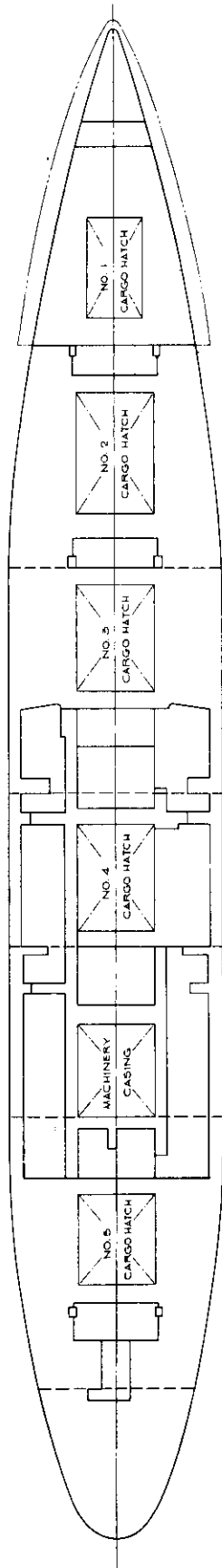

MAIN DECK

FIGURE 1
 GENERAL ARRANGEMENT - SS JAMES LYKES

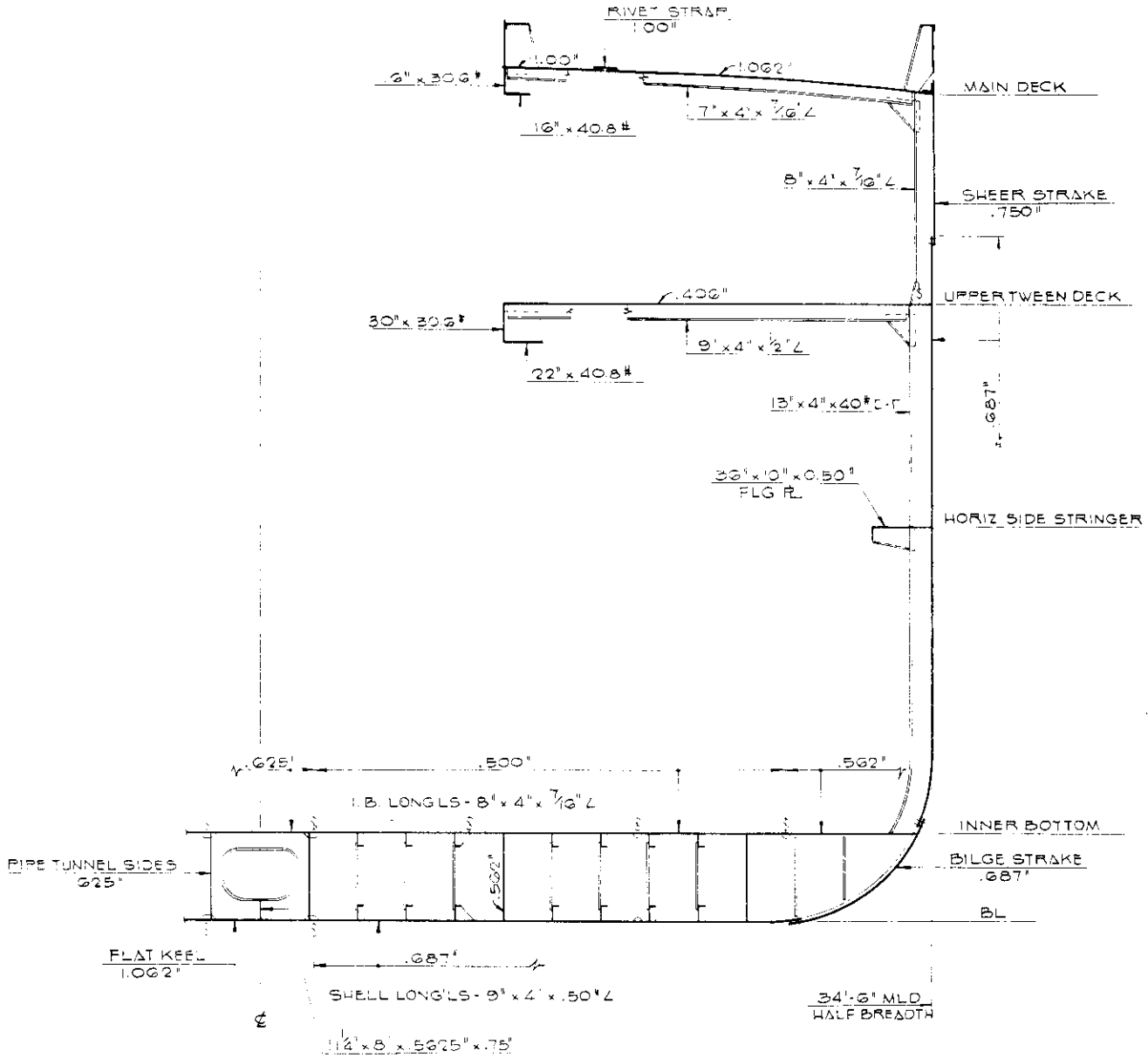

FIGURE 2

MIDSHIP SECTION - SS JAMES LYKES

II. MATERIAL AND DESIGN STUDIES

IIA. REVIEW OF GRP MATERIALS

In this section, the basic materials presently in use for fabricating GRP marine structures will be briefly reviewed to determine those which would be applicable to the construction of a large cargo vessel (or major components of the ship's structure) in the immediate future. This investigation is based upon a review of state-of-the-art materials and their properties, and will include resins, reinforcements and core materials.

RESINS

The selection of resins involves consideration of the following factors:

- o polyester vs. epoxy
- o rigid vs. semi-rigid or flexible
- o fire-retardant vs. general purpose
- o isophthalic vs. orthophthalic
- o air inhibited vs. non-air inhibited
- o fillers, including thixotropic additives and pigments
- o curing cycles and catalyzation systems

Polyester vs. Epoxy. Polyester resins, similar to MIL-R-7575 or commercial equivalents, are recommended for the subject application in preference to epoxy resins, for the following reasons:

- o Less expensive.
- o Have adequate strength. Although epoxies will result in higher strength laminates under controlled conditions, this potential is not as significant in field applications where cure is taking place at room temperature and without pressure.
- o Most epoxies have a tendency to lose viscosity as the heat of exotherm increases, and will drain from vertical or inclined surfaces.
- o Polyester resins allow the use of the simplest and most versatile production techniques of all thermosets, and do not present the personnel hazards of epoxies.
- o Good chemical resistance in the presence of potential fuels and cargoes to be carried.
- o Better mold release.
- o Somewhat better heat resistance.

Epoxies possess superior abrasion resistance, less water absorption, greater bonding strength and much lower shrinkage. In addition, they provide somewhat greater flexibility in imparting desired mechanical or resistance properties than polyesters. However, these advantages are not considered sufficient to offset the disadvantages of epoxies, particularly with regard to cost.

Rigidity. The use of flexible or semi-rigid resins offers potential advantages in increasing the resistance of laminates to impact loads, such as hull slamming. However they offer relatively little advantage for the primary hull structure of a cargo vessel, due primarily to the increased overall hull flexibility. Therefore general purpose resins are recommended for structural laminates, though a more resilient formulation would be desirable for gel coats.

Fire Retardancy. The use of fire-retardant polyester resins will be evaluated fully in the subsequent studies of fire resistance. The materials test program for the U.S. Navy fiberglass minesweeper program, Reference (7), showed that state-of-the-art fire-retardant resins do not affect laminate strength significantly, though a weight increase of about 7 per cent can be expected. Therefore the use of such resins at the surface of laminates will not degrade properties. Certain fire-retardant additives will reduce laminate transparency and may discolor when exposed to sunlight for extended periods. However, these factors are not considered significant, particularly since present laminate visual inspection techniques are of little value for very thick laminates.

Isophthalic vs. Orthophthalic. Isophthalic polyesters have found increasing use as gel coat resins for GRP boats because of their greater resistance to water, toughness, abrasion resistance and colorfastness. Reference (18) indicates an apparent marked superiority of isophthalic resin over orthophthalic resins in strength and stiffness retention, both in terms of outdoor weathering and immersion in water. This data is over 13 years old, however, and subsequent improvements in general purpose orthophthalic resins are credited with reducing this apparent advantage to the point that the higher cost of isophthalic resins is often not justified for general laminating resin. Further long-term weathering and water immersion tests are required to fully satisfy this question.

Inhibition of Cure. The addition of paraffin wax to polyester resins to promote cure in the presence of air is widely accepted, both in commercial and military boat construction. This presents significant problems in secondary bonding, due to the necessity of removing the wax film before laying up the bond. For this reason, it is proposed to develop fabrication concepts for air-inhibited resins to provide better secondary bond strengths. This will involve the development of a post-cure system to exclude air from the non-mold surface of the layup after completion, such as the use of a peel ply of reinforcement or spray-up of an air-excluding film. Though this is not now common practice, it does not appear difficult to develop a workable system.

Fillers. The use of fillers, such as silicon dioxide to make the resin thixotropic, i.e. increasing its viscosity when at rest to prevent running on vertical surfaces, is recommended for those components of the hull structure that must be fabricated in a vertical or inclined position. Thixotropic resins are available pre-compounded from the manufacturer. Fillers are added

to gel coat resins to reduce shrinkage, minimize crazing and to improve surface finishes. Laminates containing fillers may be opaque, making visual inspection difficult. Pigments may be added to both the resin and gel coat to impart permanent color. Although this impairs visual inspection of the laminate, this is not considered objectionable.

Curing Cycles and Catalyzation. Fiberglass reinforcement and properly catalyzed resin can be cured to a hard structural laminate by either the application of heat from an external source, heat cure, or by the addition of an accelerator to the resin catalyst mixture to produce sufficient internal heat to cure the laminate at room temperature. Heat cure has been used to produce small parts with superior physical properties on a mass produced basis. Due to the rapid cure cycle, cost of the heated molds and the cost of the large external power supplies, the use of heat cure for larger lay-ups such as required for the proposed cargo vessel is considered impractical.

For a room temperature cure, the curing cycle or "gel time" of a resin is a function of the type and concentration of the catalyst and accelerator. By adjusting the percentages of catalyst and accelerator the fabricator can adjust cure time to provide adequate time for impregnation and layup of the reinforcement prior to the start of resin hardening. For normal boat layups, with laminate thicknesses of one-half inch or less, gel times as short as 30 minutes are common. However, for thicker laminates such as those required for a large cargo ship, the heat of cure, or exotherm, would be so great with such short gel times that laminate distortion and poor quality would result. Thus the question of proper gel time for thick laminates must be given careful consideration. Accelerators and catalysts will only work together in certain combinations. The following combinations are most commonly used for hand layup of polyester resin:

- o Catalyst: Methyl Ethyl Ketone Peroxide (MEK)
Accelerator: Cobalt Naphthanate

- o Catalyst: Cuemene Hydroperoxide
Accelerator: Manganese Naphthanate

The former combination should not be used for gel times exceeding four hours.

Recent advances in ultraviolet (uv) curing permit the curing of pre-impregnated reinforcement under direct exposure to uv energy. Since the cure cycle is directly dependent on the application of uv energy, it is possible to eliminate pre-cure and to control the cure cycle very closely. In addition, no appreciable exotherm results, and cure times can be considerably reduced with thin laminates. However, present uv cure technology is primarily based upon vacuum bag curing of relatively small, thin laminates under closely controlled conditions. Manufacturers of uv prepregs do not feel that the technology is presently applicable to the cure of large GRP components, or that a technological breakthrough can be expected in the near future.

The use of radio frequency curing of resins has led to the development of "pultruded" structural GRP sections such as I beams and channels, which could be used in fabricating GRP ship structures. These sections are formed by drawing continuous fiberglass strands through a die, and injecting and curing the resin in a continuous operation. The unidirectional orientation of the glass fibers results in high axial and bending strength.

REINFORCEMENTS

Reinforcing materials are made from very thin glass filaments drawn together to form continuous bundles, known as strands. The strands are used to make various types of reinforcements such as cloth, woven roving, mat, and unidirectional rovings. The glass filament used in boat hull construction is a lime-alumina borosilicate E glass of low alkali content, which has high chemical stability and moisture resistance. The higher strength S glass is not used because of its high price.

Cloth. Cloth is a plain square open weave material, used primarily in small boat construction for surfacing the exposed areas of hulls and superstructures and for repairing laminate defects. It improves appearance, but is expensive and builds up thickness too slowly to be economical for thick laminates such as will be required for the GRP cargo vessel.

Woven Roving. Woven roving reinforcements, similar to MIL-C-19663 or commercial equivalent, consist of flattened bundles of continuous strands woven into a heavy plain weave with a slightly greater number of strands in the warp direction parallel to the length of the roll of material, than in the fill, perpendicular to the roll. Woven roving is commonly used as a reinforcement for marine applications. When layup is by the contact or hand layup molding method, woven roving has the following advantages:

- o Has good drapeability and handling characteristics.
- o Builds up laminate thickness rapidly.
- o Provides higher strength and stiffness than mat.
- o Has directional physical properties for orientation in high stress areas.
- o Has good resistance to impact because of the continuous, untwisted strands in the individual bundles.

The fine, tightly compacted filaments of the glass strands and the coarse weave of woven roving may cause resin starved areas within and resin rich areas between the individual bundles of rovings unless special attention is paid to the wet out of the plies during layup. Woven rovings weighing up to 40 ounces per square yard (compared to the 24 ounce per square yard woven roving in general use today) are within the state-of-the-art capabilities of reinforcement manufacturers. The use of these heavier woven rovings is recommended for laying up the thick laminates required for larger hulls. Mechanical impregnating and material handling systems are also suggested in order to insure proper wet out and quality control. Mechanical impregnation will provide greater control of the glass-resin ratio, increase wetting of the glass fibers, reduce resin wastage and will permit the use of polyester resins of higher viscosity. The cost of additional equipment should be offset by lower resin wastage and labor costs. A mechanical impregnation of this type was used successfully in laying up the midship test section for the U.S. Navy GRP minesweeper program. Thus the technology required to develop such equipment is now available.

Mat and Chopped Strand. The chopped-fiber type of reinforcement is available as a prefabricated mat made from short randomly oriented chopped strands of fiberglass held together with a soluble resin binder, or the glass strands may be chopped, mixed with resin and simultaneously deposited on the mold with a chopper-spray gun. Mat reinforcement has the following advantages:

- o Lower cost per pound and unit thickness than fabrics.
- o Homogeneous material with equal physical properties in all directions.
- o Good interlaminar bond due to the interlocking action of the fibers.
- o Can be molded into more complex surfaces and shapes than fabrics.
- o Easy to wet out, i.e. rapidly impregnating the glass with resin.

Contact molded mat laminates have a lower glass content than fabric laminates with a resulting lower modulus of elasticity. Thus mat laminates must be thicker in order to have the equivalent stiffness of a fabric laminate. Due to their lower glass contents, mat laminates also have lower physical strength properties than woven roving or cloth laminates.

Although chopped strands deposited with a chopper gun produces a reinforcement with properties equivalent to prefabricated mat reinforcement, it is difficult to accurately control laminate thickness and glass content. Therefore this method is not recommended for laminates where high strength or good quality control is required, unless a mechanized system can be developed for depositing the resin and reinforcement.

Unidirectional Materials. There are presently several manufacturers producing inexpensive unidirectional materials suitable for marine applications using hand layup procedures. These materials consist of continuous parallel strands of fiberglass either sewn together or bonded to a light mat backing to form a roll or bolt of reinforcement. In addition to the pure unidirectional material, with all fibers parallel to the warp, there are a number of possible variations with bundles of glass in the fill direction as required to suit strength requirements. The percentage of glass in the warp and fill direction can be varied over a wide range. These materials offer high strength and stiffness in the warp direction, and maximum freedom to optimize weight-strength relationships. They are generally somewhat more expensive than woven roving, though purchases of large quantities of material would reduce this differential. To date, the primary use of unidirectional reinforcements of this type for marine applications has been in the production of large sailboat hulls, particularly in Canada. No attempt has yet been made to mechanically preimpregnate and lay down these unidirectional reinforcements, though this would not appear to be a problem.

Sizes, Finishes and Binders. Sizes and finishes are chemical treatments applied either during the manufacture of the fiberglass filaments or to the reinforcement after it is woven into cloth and cleaned to improve the chemical bond between the molding resin and the glass filaments. For use with polyester

resins, silane, chrome or other type sizes and finishes compatible with the resin are used, although the silane types are recommended for marine applications since greater laminate wet strength is obtained. Highly soluble polyester resin binders are used to hold together the short randomly oriented chopped strands of mat reinforcement during handling and layup.

GRP Composites. Composite fiberglass reinforcements, particularly alternating plies of mat and woven roving, are used extensively in commercial small boat hull construction. This composite reinforcement provides improved interlaminar bonds between successive plies, reduced porosity, and allows several plies to be laid up at one time. In addition, the resultant weight-strength and weight-stiffness characteristics appear to be ideal for small boat hulls except where maximum weight is required for high performance. Since the GRP cargo ship is relying heavily on reduced weight to increase available cargo deadweight, the use of a low-strength composite GRP laminate is not justified.

Preimpregnated Reinforcements. Preimpregnated reinforcements are reinforcements preloaded with polyester or other molding resins which are either laid up immediately or stored for later use. The preimpregnating is usually done by machine in order to better control the glass to resin ratio. In addition to greater control of the glass-resin ratio, preimpregnated reinforcements provide increased wetting of the glass fibers, reduced resin wastage and allow the use of high viscosity resins. The additional equipment and storage facilities required, the reduced storage life and handling difficulties during layup due to the tackiness of the resin are the major disadvantages of preimpregnating. However, serious consideration must be given to preimpregnated reinforcements for the GRP cargo ship, in conjunction with mechanical lay-down and wet-out.

CORE MATERIALS

Many materials are used as structural cores for stiffeners and sandwich panels; including wood, foamed plastics and honeycomb. The selected core material should have good shear strength and rigidity; ability to bond adequately to the facings with a minimum of difficulty; resistance to deterioration due to water, fungi, and decay; light weight; and sufficient crushing strength to withstand local loading, such as fork lift tires rolling on a deck.

Wood. Hard woods, plywood and balsa are some of the typical types of wood used as core materials. Plywood has good strength, rigidity and ability to withstand local loads. However, plywood is relatively heavy and should be of marine grade only. Hard woods should not be used since they have a tendency to swell and crack the covering laminate. Both hard and soft woods, except balsa, are similar to plywood in that they are too heavy to perform efficiently as sandwich cores. Balsa wood, while providing the necessary lightness, would have to be built up in layers in order to obtain the core thicknesses required for the subject application. Because of possible rotting, swelling and degradation, the use of wood cores in areas below the waterline or adjacent to tanks is not recommended for the GRP cargo ship.

Foamed Plastics. Foamed plastics such as cellular cellulose acetate (CCA), polystyrene, polyurethane and polyvinyl chloride (PVC) offer the advantages of light weight and resistance to water, fungi and decay. Low compressive strength, especially of the very light weight foams, makes them susceptible to damage from local impact loads. Low foam shear strength often dictates the use of GRP shear webs between faces to avoid excessive core thickness on highly-loaded panels. Polystyrene is not recommended, since it will be attacked by polyester resins. For the GRP cargo ship, neither CCA or PVC foams are recommended, due to high cost. Polyurethane is acceptable, though the effective use of this foam as a core material, like all foams, dictates the layup of the GRP laminate onto the foam, rather than pressing the foam into the laminate, to provide a good skin-to-core bond. Alternatively, vacuum bagging can be used, though this is quite expensive.

Honeycomb. Honeycomb cores of aluminum, fiberglass laminates, cotton duck, waterproof paper and nylon are available in various sizes and weights. They have light weight, good rigidity, poor resistance to concentrated local loads and require highly developed fabrication techniques to assure good bonding between core and facings. Imperfect core-to-facing bonds will permit water travel throughout the core in the event of a leak. The use of honeycomb cores in marine construction is usually limited to interior decks, flats and bulkheads. For the GRP cargo ship, honeycomb has not been considered for primary structural elements.

Microballoons. Light weight hollow glass or gas-filled phenolic spheres and polystyrene beads embedded in resin are examples of the high density, trowelled-in-place type of core material presently being used in certain areas of some small boat hulls. In general, their high cost has limited their use to local areas where high core strength is required, such as in way of engine mounts, etc. Alternatively a local core insert of vermiculite and resin (80 per cent resin by weight) can be used.

PHYSICAL PROPERTIES - STATIC

The physical properties of typical marine GRP laminates are available from a number of sources, including References (9) and (10). Table 2, derived from Reference (10), presents average design values which are considered suitable for this study. It is noted that the properties of GRP laminates vary widely because of the variations inherent in the hand layup process. This variation is reflected in the safety factors selected in the design criteria. The properties in Table 2 are somewhat lower than those applicable to Navy or U.S. Coast Guard boats, as reflected in MIL-P-17549C, but are considered typical of commercially fabricated GRP marine structures.

The average physical properties of unidirectional laminates produced by the hand layup process are highly variable, depending upon the per cent glass present in the laminate. Table 3 presents typical values for the warp direction of a high strength laminate utilizing unidirectional rovings. The tensile and flexural properties are derived from Reference (11). Compressive properties are assumed due to lack of test data. The properties in the fill direction would be far lower. The values in Table 3 assume that the rovings are not prestressed during the cure cycle.

TABLE 2

PHYSICAL PROPERTIES OF TYPICAL MARINE GRP LAMINATES (a)

Average Values for Guidance Only

Physical Property (b)(d)	Chopped Strand Mat Laminate Low Glass Content	Composite Laminate (c) Medium Glass Content	Woven Roving Laminate High Glass Content
Percent Glass by Weight	25 - 30	30 - 40	40 - 55
Specific Gravity	1.40 - 1.50	1.50 - 1.65	1.65 - 1.80
Flexural Strength PSI x 10 ³	18 - 25	25 - 30	30 - 35
Flexural Modulus, PSI x 10 ⁶	0.8 - 1.2	1.1 - 1.5	1.5 - 2.2
Tensile Strength, PSI x 10 ³	11 - 15	18 - 25	28 - 32
Tensile Modulus, PSI x 10 ⁶	0.9 - 1.2	1.0 - 1.4	1.5 - 2.0
Compressive Strength, PSI x 10 ³	17 - 21	17 - 21	17 - 22
Compressive Modulus, PSI x 10 ⁶	0.9 - 1.3	1.0 - 1.6	1.7 - 2.4
Shear Strength Perpendicular, PSI x 10 ³	10 - 13	11 - 14	13 - 15
Shear Strength Parallel, PSI x 10 ³	10 - 12	9 - 12	8 - 11
Shear Modulus Parallel, PSI x 10 ⁶	0.4	0.45	0.5

(a) Properties from short term loading tests - wet condition. Composite and woven roving values for warp direction.

(b) Tested in accordance with ASTM Standard Specification or equivalent Federal Standard LP-406b.

(c) Based on typical alternate plies of 2-oz./sq.ft. mat and 24 oz./sq.yd. woven roving.

(d) Strength values are ultimate strengths.

TABLE 3

AVERAGE ^(a) PHYSICAL PROPERTIES - UNIDIRECTIONAL GRP LAMINATES

Per Cent Glass by Weight, %	60-65
Specific Gravity	1.9
Flexural Strength, PSI	114,000
Flexural Modulus, PSI	4.1×10^9
Tensile Strength, PSI	110,000
Tensile Modulus, PSI	3.9×10^6
Compressive Strength, PSI	100,000
Compressive Modulus, PSI	3.9×10^6

(a) Average values for Guidance Only, Warp Direction.
Strength values are ultimate strengths.

Table 4 presents assumed properties of a proposed composite laminate consisting of 50 per cent woven roving and 50 per cent unidirectional reinforcement. This composite is desirable to provide adequate transverse and diagonal strength to the laminate, which cannot be achieved with the unidirectional reinforcement only. Alternatively, cross-ply of unidirectional reinforcement could be used.

Typical physical properties of core materials obtained from the sources cited are shown in Table 5.

TABLE 4
 APPROXIMATE ^(a) PHYSICAL PROPERTIES OF WOVEN ROVING
 UNIDIRECTIONAL COMPOSITE LAMINATE

Per Cent Glass by Weight, %	65
Specific Gravity	1.8
Flexural Strength, PSI	65,000
Flexural Modulus, PSI	2.9×10^6
Tensile Strength, PSI	65,000
Tensile Modulus, PSI	2.9×10^6
Compressive Strength, PSI	60,000
Compressive Modulus, PSI	3.0×10^6

(a) Average values for Guidance Only, Warp Direction.
 Strength values are ultimate strengths.

TABLE 5
 AVERAGE PHYSICAL PROPERTIES - CORE MATERIALS

<u>Property</u>	<u>M A T E R I A L</u>			
	<u>PVC</u> (Thermo- setting)	<u>PVC</u> (Thermo- plastic)	<u>Polyur-</u> <u>ethane</u>	<u>End Grain Balsa</u>
Density, Lb./Cu.Ft.	6	5	5	6
Ult. Tensile Strength, PSI	-	-	200	1375 parallel to grain 112 perp. to grain
Ult. Compressive Strength, PSI	250 at 10% compr.	60	200	500 parallel to grain 84 perp. to grain
Ult. Flexural Strength, PSI	-	160	300	825 parallel to grain
Ult. Shear Strength, PSI	170	240	100	170
Source, Reference	(12)	(13)	(14)	(15)

PHYSICAL PROPERTIES - FATIGUE

The fatigue strength of typical GRP laminates relative to that for steel is shown in Figure 3, based upon data from Reference (9). These data are based primarily upon mat and cloth laminates. Lack of data on fatigue of unidirectional and composite laminates makes it necessary to use these data for those materials as well. The single curve is considered applicable to tensile, flexural, compressive and shear strength of GRP laminates, for full stress reversal.

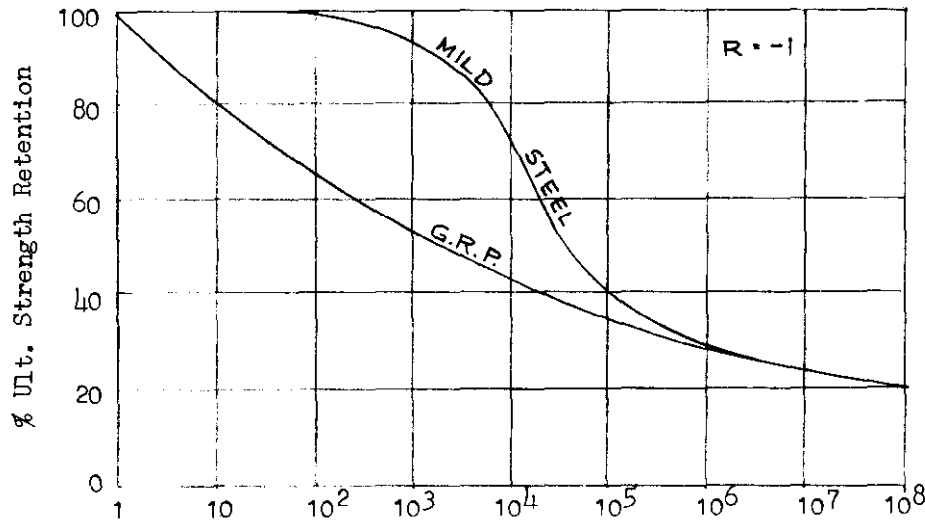

FIGURE 3

S-N CURVES OF STEEL AND GRP LAMINATES

Reference (9) indicates that the fatigue strength of notched specimens is about 15 per cent less than that of an unnotched specimen in the range of from 10² to 10⁴ cycles, though this difference reduces to zero at the extremities of the curve, i.e. the ultimate strength retention of notched specimens of 10⁸ cycles is about 20 per cent.

The fatigue strength of GRP laminates exposed to elevated temperatures and extreme weathering conditions or immersed in water will be less than that shown in Figure 3, though the data available to date are too limited to present quantitative information on these effects.

In summary, it is considered that the relative fatigue strengths shown in Figure 3 are satisfactory for this study, though further research is required to fully delineate the fatigue behavior of GRP.

CREEP

Reference (9) presents data which indicate that creep, or deformation under constant stress, is negligible for GRP laminates at room temperature if stress levels are kept to 20 to 30 per cent of the ultimate strength. For higher continual stress levels or higher temperatures, however, creep can be significant and must be carefully considered.

The heat distortion temperature of the thermoplastic PVC foam is relatively low, (Reference (28)) resulting in possible creep of PVC-cored deck surfaces subjected to direct sunlight or internal heat. This characteristic is not necessarily a disadvantage, but one which must be recognized in designing structures with this material.

IMPACT STRENGTH

Data in Reference (9) indicate that the impact strength of GRP laminates incorporating cloth or woven roving reinforcement is about twice that of mat laminates of equal thickness or weight. It is not possible to equate these quantitative impact strength data on GRP laminates to those for steel or aluminum due to differences in test methods. However, general observations of GRP boat hulls over extended periods indicate that the impact strength of GRP is quite satisfactory for the normal range impact loads such as slamming, where the structure responds elastically. This is primarily due to the highly resilient nature of the material. Under extreme conditions of impact, GRP panels suffer from their inability to respond plastically. Thus, whereas a steel or aluminum panel would dish, GRP laminates will craze around the edges and in way of the load. If the load is sufficiently severe, rupture of the panel will occur. As noted previously, there are no data available to indicate whether a GRP panel will craze or rupture under impact enough to lose watertightness at a lower energy level than an equivalent steel or aluminum panel. However it would appear that metals would be somewhat superior to GRP in this regard, due primarily to their ability to deform plastically.

BUCKLING STRENGTH

The tendency of GRP structures to buckle is considerably more pronounced than with metals due to the much lower modulus of elasticity of GRP. This places increased importance on checking GRP plate panels and columns to determine their ability to resist buckling loads. In general, it is satisfactory to analyze GRP panels and columns using conventional theoretical techniques, treating the material as isotropic, and considering compressive moduli and ultimate strengths.

Buckling must also be carefully considered in selecting the dimensions of stiffening members, both to prevent local buckling of the webs and over-all instability of the member. These considerations suggest the use of curvature in laminate panels wherever possible and lateral supports for exceptionally deep framing members.

SECONDARY BOND

A secondary bond is defined as any bond between two GRP structures which is made after one or both of the individual structures has effectively cured. In this case, the bonding resin is essentially "gluing" itself to the pre-

cured part, and proper surface preparation is essential in producing a good mechanical bond, particularly when non-air inhibited resins are used which produce wax film. The alternative to secondary bonding is primary bonding, in which both parts are uncured when the bond is made. In this case the bond strength is based upon a chemical linkage as a result of continuous cure of the resin. Primary bonds exhibit higher strength than secondary bonds, and are recommended wherever possible.

The question of secondary bond strength is of major concern to the GRP industry, since the inability to achieve full effective laminate strength at joints requires the use of excessively high safety factors and prohibits the designer from taking maximum advantage of the properties of GRP.

Perhaps the most extensive investigations of secondary bond strength were those undertaken in connection with the U.S. Navy's GRP minesweeper program. Reference (16) summarizes the results of the initial test program and provides considerable quantitative data on static and impact bond strength. In reviewing these results, the following conclusions were reached:

- o Preferable bonding procedures are as follows:

Bond resin: general purpose or fire-retardant, resilient.

Surface treatment: bumped with a pneumatic saw tooth hammer, peel ply, or continuous cure of rib to panel; one ply of mat in way of bond.

Faying flange thickness: minimum consistent with rib strength requirement.

Bolts or other mechanical fasteners are recommended in areas of high stress.

- o Acceptable procedures are as follows:

Bond resin: general purpose or fire-retardant, rigid air inhibited.

Surface treatment: rough sanding.

- o Undesirable procedures are as follows:

Excessive rib faying flange thicknesses.

No surface treatment in way of bond.

Recent tests conducted in Great Britain for their GRP 153 foot Mine-hunter indicated that the peel ply method is the most effective.

The ability to satisfactorily fabricate structurally sound secondary bonds is essential to the feasibility of the GRP cargo ship. Experience to date with the performance of secondary bonds in GRP pleasure and commercial vessels up to 80 feet long has been quite good. However, this does not obviate the need for far more research in this area.

RESISTANCE TO ENVIRONMENT AND AGING

The ability of GRP to resist a marine environment is well documented. GRP is composed of substances which do not rot or suffer attack by marine organisms, other than attachment of barnacles and grass. However, the latter condition can be effectively controlled with the same anti-fouling paint systems used with metal vessels.

GRP laminates are compatible with all anticipated cargoes and fluids which would normally be carried in a dry cargo ship, including fuel oil. The only known effect of GRP on a cargo or fluid is the possible taste of polyester imparted to drinking water when the resin is not fully cured. However, this can be overcome using techniques now employed in the small boat industry.

Table 6, derived from Reference (18), presents data on the chemical resistance of the various types of resins normally used in GRP boatbuilding. These data are perhaps academic for the general design of a GRP cargo ship, since the listed chemicals are seldom if ever carried. However, this information is useful in considering GRP components, such as liquid cargo tanks, or alternate types of GRP ships. This table shows that the chemical resistance of general purpose polyester resin is generally good, though in certain cases, epoxy resins or polyurethane linings are recommended.

GRP laminates which are immersed in water over extended periods will have wet strengths approximately 85 to 90 per cent of their dry strength due to the effects of the water on the bond between the glass fibers and the resin.

Reference (18) projects a loss in strength and stiffness of about 50 per cent over 20 years. However, this data is old, and is not considered representative of recent improvements in glass finishing and resins. Reference (17) indicates substantially no change in wet strength of a GRP submarine fairwater after 11 years service including submergence at high pressures.

GRP laminate strength is adversely affected by high temperatures. For a typical laminate incorporating fire-retardant polyester resin the per cent strength retention at 200 degrees F, 300 degrees F and 400 degrees F are 90, 50 and 10 per cent respectively of the strength at room temperature. Thus it is concluded that GRP structures can withstand continuous exposure to temperatures of about 150 degrees F - 200 degrees F and intermittent exposures to higher temperature. Since polyester resin is a thermosetting resin, it is unlikely that the laminate would regain strength after removal of the heat source. This loss in strength at elevated temperatures must be considered when designing tank heating systems.

The properties of GRP in a cold or supercooled environment are higher than at room temperature. Thus operation of a GRP ship in cold climates will not degrade its strength.

The core materials being considered vary in their ability to withstand the environment and aging. Wood, including balsa, is organic and subject to rotting, decay and general loss of strength if not properly preserved or encapsulated with GRP. For this reason wood cores are not being considered for use in the primary structure of the GRP cargo ship.

TABLE 6

CHEMICAL RESISTANCE OF TYPICAL GRP RESINS

+ = resistant; † = questionable; - = not recommended

Chemicals to be transported	Polyester resins			Epoxy resin	Polyurethane lining
	General purpose resin	Isophthalic acid resin	Bisphenol resin		
Acetone	-	-	-	+	+
Spent acid			+	+	+
Ammonia (aq.)				+	+(5%)
Benzene	-	-	-	+	+
Butanol	+	+	+(up to 80°C)	+	+
Butylacetate	+	+		-	±
Carbontetrachloride	+	+	+(up to 30°C)	+	±
Caustic soda (48%)	-	+	+	+	+(10% 4 weeks)
Chlorobenzene	+	+	+		
Naphthenic acid					
Di-isobutylene	+	+	+	+	+
Dimethylamine (40% Aq. sol.)			-		
Dimethylformamide (tech.)			-		
Diocylphthalate			+		
Ethanol	+	+	+(up to 80°C)	+	+
Ethylacetate	-	-	+	±	
Ethylbenzene	+	+		+	+
Ethylenedichloride	-	-	-	+	
Ethyleneglycol	+	+	+	+	
Furfural	-		+(5%)		
Furfurylalcohol			+(up to 70°C) 5%		
Glycerol			+		
Hexane	+	+	+	+	+
Methanol	±	±	+(up to 60°C)	±	
Methylethylketone	-		+(up to 30°C)		
Methylmethacrylate (monomer)			-		
Methylenechloride	-		-	-	
Formic acid			+(up to 85%)		
Octanol	+	+	+	+	+
Orthoxylene	+	+	+(up to 30°C)	+	+
Chloroparaffine			+		
Perchloro-ethylene			+(up to 30°C)		+
Phenol	-	-	-		
Pine oils	+	+	+	+	+
N-propanol	+	+	+	+	+
Propionic acid			+		
Solvent naphtha	+	+	+	±	+
Styrene (monomer)	+	+	+	±	+
Sulphuric acid	±	+	+(up to 70°C) 70%	± (30%)	±
Synthetic latices (various grades)					
Talloil fatty acids	+	+	+	-	-
Toluene			+(up to 30°C)	-	+
Trichloro-ethylene	-		-	-	-
Turpentine (gum and distilled)			+		
Vinylacetate (monomer)	±		-		
Xylene	+	+	+(up to 30°C)	+	+
Various vegetable oils	+	+	+	-	+
Sulphite			+		

Foams generally are quite resistant to the effects of age and environment with two exceptions. Light density foams, less than 4 pounds per cubic foot, are subject to embrittlement and may become friable and disintegrate with time. Therefore such foams are not recommended. Thermoplastic PVC begins to lose stiffness at temperatures above about 120 degrees F, and requires additional support to prevent sagging.

ABRASION RESISTANCE

GRP laminates are not as abrasion resistant as metals, though the bottoms of GRP landing craft have stood up well under repeated beachings (Reference (8)). Special protection is recommended in areas where heavy abrasion might be expected. Examples would include:

- o Rubbing strips near the waterline to prevent damage from pier pilings.
- o Protection for the side shell in way of anchor bolsters and mooring chocks.
- o Protective deck coatings in areas where cargo may be skidded.
- o Chafing strips in way of hatch coamings for protection from cargo whips.

There is presently no known quantitative data on wear rates of GRP laminates relative to those of steel. Thus the approach to abrasion protection must be empirical or based upon future testing.

MATERIAL COSTS

The final factor to be considered in selecting materials is cost. Table 7 presents cost data on the more common GRP basic materials of high quality, when purchased in large quantities. These prices are highly variable, dependent upon competitive conditions.

TABLE 7
GRP MATERIAL COST

<u>Item</u>	<u>Cost per Pound</u> <u>(\$ US, 1970)</u>
Mat	0.50
Woven Rovings	0.50
Unidirectional Rovings	0.62
General Purpose Polyester Resin	0.20
Fire-Retardant Polyester Resin	0.31
Polyurethane Foam	1.50
End Grain Balsa	1.50
PVC	3.00

SELECTION OF GRP MATERIALS

Based upon the foregoing discussion of GRP materials, the following materials and laminate configurations are proposed for further consideration in evaluating a large GRP cargo ship or major structural component:

- o Resins. Use general purpose rigid air inhibited polyester resins except where fire retardancy is required. Epoxies are not recommended because of high cost, handling problems and marginal strength advantages in hand layup applications. Resilient resins might have applicability locally in way of secondary bonds but general use would result in unacceptably large deflections. Non-air inhibited resins require removal of wax film before making secondary bonds, which is undesirable and lowers bond strength. Fire-retardant resins, as shown later, add weight and cost to the hull, which suggests limiting their use to plies near the exposed surfaces, particularly with thick laminates. Isophthalic resins appear preferable to orthophthalics in increasing wet strength retention, but further testing and study is required to fully justify their selection.
- o Reinforcements. Either woven roving or unidirectional reinforcement, or combinations thereof, of the maximum weight and width consistent with the equipment used for wetout and laydown are selected. Cloth is too expensive, and mat has too low a strength-to-cost ratio and insufficient impact strength for general use. Mat can be used in way of secondary bonds and as a light backup for unidirectional rovings.
- o Core Materials. Foams of structural grade, 6 to 8 pounds per cubic foot density, or end grain balsa wood are acceptable, with the following limitations:
 - End grain balsa is not recommended for shell panels below the waterline or in way of tanks.
 - Thermoplastic PVC is not recommended where exposed to high temperatures.
- o Laminate Compositions. An all woven roving laminate or a composite laminate of woven roving and unidirectional rovings are recommended, based upon high strength, relatively low cost and ease of layup. As an alternate to the above composite laminate, a bidirectional material with higher strength in the warp direction than in the fill direction would be satisfactory. For example, a reinforcement with 70 per cent of its glass in the warp direction and 30 per cent in the fill direction would have properties approximately equivalent to the composite proposed above.

IIB. STRUCTURAL CONCEPTS

In this section, the construction concepts best suited to laying up a large GRP cargo ship will be evaluated and selected. Ideally, such a study would encompass detailed trade-off studies, including cost optimization studies. Such studies are beyond the scope of this program, however, and are not justified, since the accuracy of the cost estimates cannot be refined sufficiently to justify an extensive effort to optimize the structure. Therefore, these proposals are presented on the basis of extrapolating previous similar studies for the GRP minesweeper, Reference (7), and engineering judgment.

SINGLE SKIN VS. SANDWICH

The choice of single skin construction vs. the use of sandwich panels involves the following considerations:

- o Sandwich panels are generally somewhat lighter than equivalent stiffened single skin panels, and have less overall depth.
- o Sandwich panels are generally more expensive to fabricate than equivalent single skin panels, particularly if the panel has curvature.
- o The basic hull girder of the cargo ship will be heavily influenced by longitudinal strength and stiffness considerations, implying selection of the least expensive method of providing laminate area to the hull girder, particularly at the deck and keel.
- o The overall depths of decks, sideshell and double bottom should not be increased beyond those of the steel ship, to prevent reduction in available cargo volume.
- o The thickness of hull girder laminates, must be sufficient to resist impact loads, abrasion, etc. This often dictates increased skin thicknesses for sandwich panels.

Consideration of the above factors favors single skin construction in all areas except possibly flat deck panels, where depth restrictions may favor sandwich panel construction.

LONGITUDINAL VS. TRANSVERSE FRAMING

Longitudinal framing is highly desirable for the deck and bottom of the hull, to increase hull girder inertia and section modulus. The side shell should be transversely framed, spanning between decks, since longitudinal framing would require the addition of deep supporting web frames, which detract from hold volume. Transverse side framing is somewhat superior in resisting damage from docks and floats, since the line of framing is perpendicular to the bearing surface of the dock or float.

IIC. OPERATIONAL EXPERIENCE WITH EXISTING GRP VESSELS

At this time, there are many thousands of GRP boats of various sizes in operation throughout the world, many of which have seen 15 years or more of service. These vessels range in size from small prams to fishing vessels up to 93 feet long. Although there is a significant difference in size and operational environment between this group of vessels and the proposed large GRP cargo ship, a review of the operational experience of these vessels is meaningful.

GENERAL OBSERVATIONS

The performance of GRP as a structural material for marine applications has been very satisfactory and the material has demonstrated its compatibility with the salt water environment at least as well, or generally better than either woods or metals. As with any other material, there have been problems resulting from improper use of the material or failure to recognize and either avoid or accept inherent weaknesses of GRP. Many of these problems were discussed briefly in the previous section, and need not be reiterated here. However, some specific observations relative to past performance of GRP boats and structures, particularly as they apply to a larger ship, are of interest.

RESISTANCE TO ENVIRONMENT

As previously noted, the basic resistance of GRP to a marine environment is excellent, References (1) and (8). Degradation of material characteristics, particularly physical properties, has been negligible. There is little evidence to date of problems with fatigue or creep except in areas of obvious design or construction deficiencies. In general, design safety factors, have been sufficiently high to prevent such problems. Long-term weathering or aging effects have generally been limited to fading of gel coats, surface crazing, deterioration of wood cores in sandwich panels where the GRP protective surfacing was porous, and delamination of secondary bonds. In most instances, the latter problem has resulted from improper design or workmanship, though the inherent problem in obtaining a good secondary bond has been discussed previously.

ABRASION AND IMPACT

Experience with existing boats up to 80 feet long indicates that GRP is somewhat more sensitive to localized impact, such as slamming into a pier, than equivalent metal structures. For a given energy level, an impact which would scrape the surface of a metal hull will gouge GRP to a greater depth. Similarly, an impact which would plastically deform or dish a metal hull will produce crazing around the periphery of a GRP panel and possible loss of watertightness. In many cases, the aforementioned gouging is relatively shallow, and the edge crazing is restricted to the gel coat and its reinforcement, in which case the damage is cosmetic rather than structural in nature.

The abrasion resistance of GRP boats is generally satisfactory for normal service. Under extreme conditions, however, abrasion damage has resulted, at a more rapid rate and with greater severity than with metal. Examples of such damage include:

- o Wear down of trawler decks in way of fishing gear
- o Damage to deck edges and bulwarks from chafing of mooring lines

- o Abrasion of side shell at waterline from chafing against floats
- o Wear down of decks of landing craft from vehicle movements, and similar damage to bottoms from repeated beachings

This indicates the need for protection where excessive abrasive loading is anticipated.

REPAIRS

Repairs to GRP boats have proven to be generally easier than with wood or metal, and the durability of these repairs has been satisfactory, as long as they were properly made. References (19) through (24) discuss the techniques for making repairs in detail.

Repairs to badly damaged laminates are generally accomplished by cutting away the damaged material, scarphing the edges and laying up a patching laminate using the same materials as those being replaced. The process is simple, requires a minimum of equipment and technical skills, and is relatively inexpensive to perform. The fundamental weakness of such repairs is that they rely upon a secondary bond between the repair laminate and the undamaged existing laminate. This requires careful attention in making the repairs if the laminate is to be restored to full strength. It is generally desirable to build up the thickness of the repair laminate by laying up an extensive doubler over the patching laminate, which overlaps well on to sound existing material. The repair can be further strengthened by the use of mechanical fasteners at the interface between new and existing laminate.

Minor damage, such as scratching, gouging or abrasion, is generally repairable with a commercial fiberglass putty or a mixture of resin and milled glass fibers.

Experience in repairing GRP boats indicates that there are several keys to affecting a good repair:

- o Careful surface preparation in way of secondary bonds
- o Adequate overlap of repair laminate onto existing sound laminate
- o Careful control of moisture and ambient temperature
- o Use of repair materials which are, as a minimum, equal in strength to the existing laminate. The use of epoxy resins for repairs will increase the strength of a repair significantly.
- o Cleanliness, to avoid contaminating the surface to which the repair laminate will bond
- o Use of a double scarph wherever possible, with the repair laminate layed up from both sides

MAINTENANCE

The maintenance history of GRP boats now in service is very good, due primarily to the material's resistance to the environment. General and preventive maintenance of GRP structures has proven to be far less than with either wood or steel, as noted in References (1), (8) and (17). In general, the maintenance required for GRP structures, other than renewal of anti-fouling bottom paint, is of a cosmetic nature. Although most GRP boats are unpainted initially, due to the use of pigmented gel coat resins, most owners eventually find it desirable to paint the hull to renew faded gel coat colors or to cover up repairs. The frequency with which this paint must be renewed is usually less than with wood or steel.

IID. FABRICATION FACILITIES AND PROCEDURES

The feasibility of a GRP cargo ship depends, to a great extent, upon demonstrating that a facility can be developed which can undertake such a task and produce a structure of satisfactory quality at an acceptable cost.

In this section, the general requirements for such a facility will be briefly discussed, and a proposed method of construction will be developed. This proposal will be based upon the fabrication of the entire vessel of GRP, rather than large structural components, since facilities already exist for producing the latter. The proposed method is not necessarily the optimum method of building such a hull. Optimization would require extensive investigations, including detailed consideration of the problem by shipyard planners, GRP boat fabricators, materials suppliers and the entire spectrum of disciplines involved in such a program. A detailed study of this nature is beyond the scope of this program. However, it is considered satisfactory at this time to develop a feasible approach to the construction of a large GRP cargo ship, and to defer studies of alternative methods and optimization.

FACILITY REQUIREMENTS

It would appear that the initial interest in fabricating large GRP ships will be limited, and that the investment required to develop an entirely new shipyard specifically for fabricating large GRP ships would be too large to justify. Therefore, it is proposed to develop a GRP facility and capability at an existing shipyard, preferably in a temperate climate. This would offer several advantages. An existing shipyard has the capability of procuring, installing and testing all non-GRP components such as machinery, cabling, ventilation, cargo gear, piping, etc. It would appear far more desirable to use existing capabilities in these areas and to develop a new capability in GRP rather than the reverse. In addition, an existing shipyard can provide the equipment required for the fabrication of such a ship, such as dry-docks, cranes, rail and road facilities, machine shops, etc.

The alternative to the above approach would be to fabricate the hull and major GRP components in a special, separate facility and tow the incomplete hull to a shipyard for outfitting and installation of machinery. However, it would appear more practical and economical to provide this facility at, or immediately adjacent to, the shipyard.

The area in which the GRP components are to be layed up must be enclosed to provide the environmental controls required to maintain both temperature

and humidity within specified limits. It appears obvious that mechanized preimpregnation will be required for high layup productivity, thus such controls are particularly important. For the proposed facility, a mean ambient temperature of 70 degrees F, is desirable in the molding area, with a maximum variation of plus or minus 5 degrees. Such a limit on variability will eliminate problems of adjusting resin-to-catalyst ratios. Although present industry practice places no limits on humidity in the molding area, an upper limit would appear desirable for layup of a ship of this size. Since opinion on the effects of humidity on laminate and bonding quality is divided at this time, this recommendation should be justified by testing.

Additional facility requirements include the following:

- o Storage areas for glass reinforcement, with both temperature and humidity controls.
- o Resin storage tanks which will maintain large quantities of resin under conditions meeting the manufacturer's recommendations for storage.
- o Resin day tanks in the molding area which will maintain the resin within the specified temperature range.
- o Resin mixing equipment which disperses resin of uniform catalyst concentration to all stations.
- o Mechanical equipment to impregnate reinforcement with a carefully controlled quantity of resin and to transfer the impregnated reinforcement to the mold surface. Such equipment has been successfully used in both the United States and Great Britain for laying up GRP minesweeper structures. For a very large hull, it may be desirable to utilize rolls of reinforcement which are wider and longer than those now commercially available.
- o Mechanical equipment for high-speed transfer of glass reinforcement from the storage area to the impregnating machines.

All of these requirements are within the state-of-the-art, though the development of specialized equipment may require considerable time and effort.

PROPOSED HULL FABRICATION PROCEDURE

The method proposed for laying up the hull of the GRP cargo ship is illustrated schematically in Figure 4. This system is based upon conventional hand layup techniques in conjunction with the mechanization discussed previously, which is a reasonably conservative estimate of the state-of-the-art in large GRP hull fabrication within the next few years.

The hull mold would be of steel, supported by trusswork, and would consist of four sections: a bottom portion which is fixed to a floating drydock, two sections incorporating the sides and bow, and a stern section. Bridge cranes and mechanized layup equipment would roll along the top of the hull mold. This entire assembly would be enclosed in an inexpensive weather envelope such as translucent fiberglass sheets over a light steel framework. This envelope would afford sufficient environmental protection and control to permit year-around layup of GRP laminates.

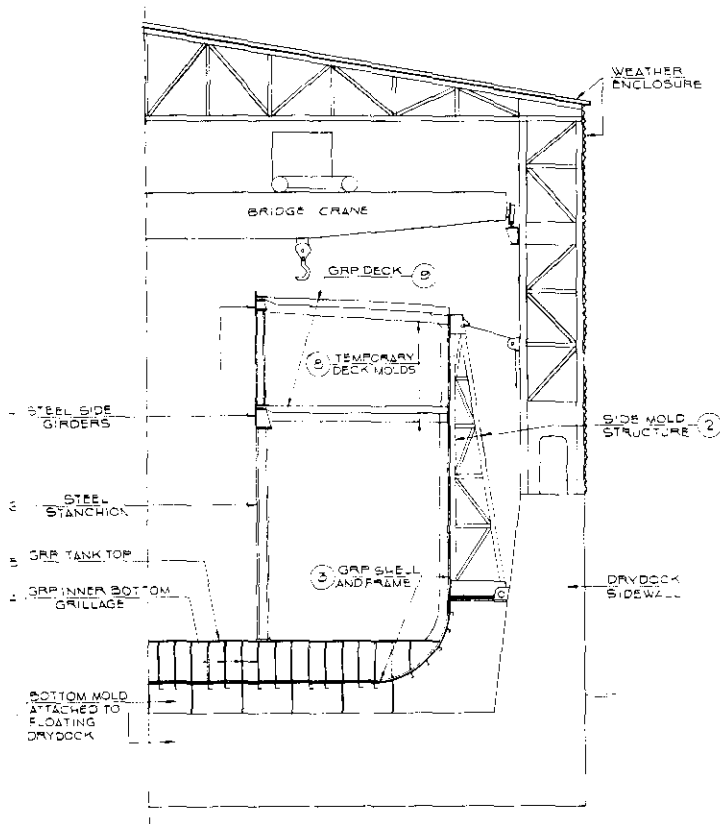

FIGURE 4. - PROPOSED HULL MOLDING AND LAYUP PROCEDURE

The layup procedure would be as follows (referring to Figure 4):

- o Floating mold (1) and side and end mold structures (2) are in initial positions as shown.
- o Shell (3) and stiffening are laid up into mold.
- o Innerbottom grillage (4) is installed.
- o Tank top (5) is laid up.
- o Stanchions (6) and side girders (7) are positioned.
- o Temporary deck molds with supporting structure (8) are installed above tank top and lowest deck sections (9) are laid up in place.
- o When lowest deck is cured, temporary structure is removed and reassembled on deck just installed and next deck is laid up. This procedure is repeated until all decks are laid up.
- o After hull is complete, the drydock is lowered and hull floats free.

Major items of equipment and machinery may be installed prior to removing the hull from the mold, though this is not necessary.

QUALITY CONTROL AND INSPECTION

The development of suitable quality control and inspection techniques for large GRP hulls represents a particularly difficult challenge. At this time, it must be concluded that state-of-the-art procedures are inadequate for a hull of this size, indicating a need for a major research and development effort.

The need for good quality control and inspection procedures is particularly critical for GRP, since the physical characteristics of the basic structure are dependent upon the abilities of the individuals laying up the laminate and controlling wetout. If suitable procedures cannot be developed, it will be necessary to resort to high safety factors to account for material variability.

Present Procedures. Before evaluating this problem further, it is desirable to review the quality control and inspection techniques now available. In general, these techniques represent those used for Navy and Coast Guard boats. Commercial standards are less severe, though the quality of the laminates produced has proven quite satisfactory. Present quality control and inspection procedures include the following:

- o Careful control of basic materials (resin, fiberglass, etc.) by MIL Specifications, inspection and testing.
- o Careful documentation by the builder of fabrication procedures, from which he may not deviate without approval.
- o High quality engineering work, including careful attention to critical details.
- o Careful control of resin gel times, pot life, viscosity, ambient temperature and other factors affecting cure.
- o Physical properties tests on laminates and sandwich panels to check against minimum allowables in the Specification. The laminate tests are based either on hull cutouts or extensions of the laminated part.
- o Laminate visual inspection for bubbles, voids, contamination or other visible flaws.
- o Use of a detailed inspection checkoff list.
- o Weighing of completed parts for uniformity.

Many of the strict quality control and inspection procedures now required by the Navy and US Coast Guard might not be practical for very large hulls, particularly visual inspection, testing of laminate cutouts, and repairs to defects in laminates. The question of quality control and inspection of GRP hull structures is presently being investigated by the American Bureau of

Shipping and the Society of Naval Architects and Marine Engineers Hull Structure Panel HS-6-3. The results of these studies should be very valuable in future studies of large GRP ship fabrication.

Future Developments. It is rather difficult to predict what the state-of-the-art in GRP quality control and inspection will be in the next few years. It is unlikely that a major breakthrough will occur, since progress in this area has been rather slow in recent years. As interest in larger GRP hulls grows, possibly through developments in GRP minesweepers, attention will be focused upon improving the most critical areas in inspection and quality control. These potential developments include:

- o Maximum use of mechanized preimpregnation and resin mixing equipment, as proposed earlier. This will control resin content very closely, which is the prime factor in controlling laminate strength.
- o More closely controlled ambient conditions in the shop, including humidity and control of temperature/humidity variations within the mold.
- o Ultrasonic laminate inspection to determine void content, thickness and the soundness of secondary bonds.
- o Improvements in secondary bonding techniques to increase reliability, by a combination of improved bonding resins and better surface preparation techniques.

It appears that the key to improving GRP quality lies more in quality control, in preventing undesirable variations and defects than in improved inspection techniques. It is invariably less expensive and more desirable structurally to prevent the problem than to find and correct it. The problem of quality control and inspection will be considerably alleviated when automated manufacturing methods are developed because of the possibility to monitor the process.

IIE. FIRE RESISTANCE

The subject of fire resistance is a very important element which must be considered in any study of the use of GRP or GRP components in the construction of a cargo ship.

All GRP laminates are considered combustible, even those with fire retardant qualities. In the presence of fire the general purpose resins used in GRP will burn away, exposing the glass reinforcement, thereby losing all of its strength. The use of chlorine and bromide compounds in the formulation of the resins and the inclusion of such additives as antimony trioxide will provide some degree of fire retardancy. However, in the presence of fire these special resins will emit toxic chlorine and bromine gases thereby presenting additional personnel hazards. Even if sufficient compounds could be used so as to significantly increase the ignition temperature and discounting the toxicity effect of the resins, a further problem, that of the loss of structural strength at elevated temperatures, must also be considered.

Current Coast Guard regulations for cargo ships, Subchapter I, Part 92.07 requires the use of incombustible materials. Construction is to be of steel or other equivalent metal construction. The use of other suitable materials may be permitted in special cases having in mind the risk of fire.

Aluminum, which is incombustible in itself but deteriorates structurally in the presence of fire, has recently been accepted in ship construction. However, this acceptance carries many conditions and restrictions. Aluminum must be protected to the degree that in the presence of fire the aluminum will not be exposed to flame and that the resultant elevated temperature of the aluminum structure be held to within a temperature of about 450 degrees F for a period of not less than one hour. The constructions incorporating the necessary insulations to accomplish the aluminum protection were the result of extensive fire testing and evaluation. These constructions are both heavy and expensive.

"Having in mind the risk of fire" precludes using materials that are combustible. Such materials would require such excessive protection as to make their consideration unfeasible from the standpoint of economics, weight and space.

Since GRP is combustible its use as a ship's structural material keeping in mind the risk of fire is not acceptable at this time under current regulations even with protection afforded similar to that used on aluminum construction. In addition to the U.S. Coast Guard regulations, proposals are currently being offered among member nations of the Intergovernmental Maritime Consultative Organization (IMCO), including the United States, for greater use of incombustible materials in ship construction.

Where proven economically feasible, certain nonstructural GRP components, such as fairings, window frames, masts, yardarms, or remote non-structural bulkheads etc., may possibly be considered, on a case basis, for use in areas affording little or no threat of fire.

For GRP to be considered as a structural material extensive testing and evaluation would be required of various types of GRP panels using resins with different basic compounds and additives as well as a number of protective systems. In addition, improved detection, extinguishing and inerting systems would have to be developed and tested for use in conjunction with the protected GRP in an effort to provide an acceptable level of fire protection.

Before any extensive testing programs are considered justification should first be established that GRP is significantly better both technically and economically than the various types of competitive incombustible structural constructions currently in use. Otherwise there is no valid incentive to deviate so significantly from present structural standards of fire protection.

Presently, no firm conclusion can be drawn relative to the feasibility of providing a satisfactory level of fire protection to a GRP cargo ship. By today's standards GRP is entirely unfeasible. For the future, any proposal to use GRP must clearly justify any intention to revise today's standards based on proven superior economic and technical advantages.

III. INSTALLATION OF SYSTEMS AND EQUIPMENT

MATERIALS

Installation of systems and equipment on a GRP cargo ship is relatively simple, since the hull material is chemically and galvanically inert. This eliminates the problem of isolation common to such installations on steel or aluminum ships, particularly the latter. The only galvanic problem which must be given consideration is the mutual galvanic interaction of various metallic components. This would include the rudder, propeller and other appendages and attachment of piping to metal equipments or fittings of different material. In general, the former problem is solved by installing sacrificial anodes, while the latter problem can be solved with conventional isolation techniques. Hull corrosion control, such as an impressed current system, would not be required.

ATTACHMENT OF EQUIPMENT

The attachment of highly loaded fittings or equipment to GRP requires careful attention to detail, including proper distribution of bolt loads to prevent bearing failure or tear out. This is generally accomplished by providing large backup plates in way of the bolts and laminate doublers.

Heavy pieces of equipment, should be bolted to a steel or aluminum sub-base which is in turn bolted through the GRP. This increases the number of bolts through the GRP above that generally provided on equipment, and spreads the equipment load over a larger area of GRP.

PIPING

The basic hull and machinery piping systems on a GRP cargo ship would be identical to those on a steel ship, except for the following:

- o Bulkhead penetrations would have to be specifically developed for GRP. In way of hot pipes, such as steam lines, special precautions would be required to prevent overheating the GRP structure.
- o Longitudinally-oriented pipe runs would have to be checked to determine the effects of the greater hull girder deflection of a GRP ship. Two solutions are possible: Use of low modulus piping materials, such as GRP or polyvinyl chloride, or provision of expansion loops.

GRP or other plastic piping is considered both technically and economically feasible for sanitary, bilge and ballast piping, as shown in Reference (25). However, these materials are flammable and are not permitted by U.S. Coast Guard regulations for use in machinery spaces or other areas where the risk of fire is high, or for firemain, fuel oil and other critical systems.

IIG. OPERATIONAL CHARACTERISTICS OF A GRP CARGO SHIP

The operational characteristics of a cargo ship will be greatly affected by the substitution of GRP for steel as the hull material, particularly in the areas of hull maintenance, repairs, special surveys and insurance. In the following paragraphs, each of these factors will be briefly discussed.

MAINTENANCE

Past experience with GRP hulls and deckhouses indicates that it is feasible and desirable to utilize pigmented resins for all external and internal surfaces. Although antifouling paint will be required below the deep load line, the gradual fading of the gel coat, as well as accumulations of scratches and other surface damage, will eventually lead to painting for cosmetic purposes. Once painted, these surfaces will require periodic renewal, though with far less frequency than on steel surfaces.

In general, it appears that normal topside maintenance will be limited to an occasional water wash and scrubbing. However, the renewal of anti-fouling paint will be required periodically, as will bottom scraping. This, coupled with requirements for maintaining equipment, appendages and outfit, etc., will result in essentially the same drydocking cycle for GRP and steel hulls. It is noted that the removal of paint and marine growth from GRP surfaces requires greater care than with steel. Conventional scraping and sandblasting methods must be modified to suit the lower abrasion resistance of GRP. Sand washing has proven successful in removing old paint from GRP surfaces.

During drydocking, special attention should be paid to the proper support of the hull on the blocks. Closely spaced keel and bilge blocks are desirable to prevent large concentrated loads and localized failure of the GRP laminate.

During drydocking, the GRP structure should be carefully checked for cracks, blisters, abrasion damage, delamination and other potential problems. Foundations and other highly loaded structures require particular attention.

REPAIRS

Obtaining proper repairs to hull damage, or minor structural modifications to a GRP ship will be more difficult than with a steel ship, since the number of large repairs yards with qualified personnel having GRP experience is very limited at this time. This results in two options: Develop a GRP repair capability in a limited number of facilities, in addition to those capable of building GRP ships, or alternately provide a mobile repair facility, including trained personnel, which could travel to various facilities throughout the world, as required, to make emergency repairs or to assist in scheduled overhaul.

If GRP gains acceptance as a hull structural material for large ships, the availability of trained GRP repair personnel and facilities will increase accordingly. However, until such a time, it must be assumed that the time and cost required for repairs to large GRP ships will be considerably higher than equivalent steel ships.

SPECIAL SURVEYS

At this time, the Regulatory Bodies have no special policy relative to additional surveys for GRP vessels. However, based upon the large size of the GRP cargo ship being considered, it would appear advisable to schedule additional structural surveys, at least for the prototype vessels. In order to be effective, these surveys should include close examination of internal structures, particularly in way of secondary bonds. Since this would entail gas freeing tanks and cleaning of all surfaces, it would be advisable to spot check in a limited number of tanks, and check others only if problems are uncovered. Additional items to be checked would include those noted in the previous discussion of hull maintenance, as well as a careful examination of shell and deck laminates for signs of cracking or deterioration.

HULL INSURANCE

The cost of hull insurance for a GRP cargo ship will undoubtedly be higher than that of an equivalent steel hull, due to its higher replacement and repair cost and the greater risk of loss by fire. The relative increase is difficult to predict, since it is dependent upon the degree of fire protection provided, types of cargo to be carried, risk of fire as affected by type of machinery and equipment installed and other factors.

DISPOSITION OF THE HULL

The scrapping of an obsolete GRP ship presents some rather unusual problems, since GRP cannot be easily disposed of or rendered into a useful or reusable product. Cutting the hull into small pieces and burning the scrap is feasible unless the hull is fabricated with a fire-retardant resin. However, this would be very costly and would generate a significant quantity of air pollution. Scuttling the hulls at sea would be the most economical means, but would be considered "dumping" and therefore in conflict with current policies on pollution and ecology. It would appear, therefore, that the most practical solution to the scrapping of a large GRP hull would be to sink it as part of a landfill or harbor development program, or possibly as a fish habitat.

III. SUMMARY

In this section, the basic characteristics of GRP have been reviewed, including past performance and potential applicability as a structural material for large ship hulls. This review confirmed the suitability of GRP for use in constructing vessels of up to approximately 200 feet in length as demonstrated by past studies.

As vessel length increased beyond 200 feet a number of additional factors affecting hull material selection must be considered. For example, hull girder loading and longitudinal strength and/or stiffness become more important than local considerations in selecting scantlings. Fatigue loading becomes a more serious consideration. Higher nominal stress levels are generally accepted, leading to greater concern for notch sensitivity and propagation of failures initiating at hard spots and discontinuities.

For some materials, this change in loading has a profound effect on maximum ship size. For example, wood construction proved feasible for clipper ships and schooners of up to about 300 feet in length. Beyond this, the problems of providing adequate hull tightness, strength and stiffness, particularly at plank seams and butts, proved technically prohibitive. On the other hand, there does not appear to be any technical limit on the size of a steel ship based solely on material capability. No matter how large the ships become, it would be possible to provide sufficient material to withstand anticipated over-all and local loading.

At this time, it appears that the fabrication of a GRP cargo ship 500 feet long is within the state-of-the-art. However, there are serious questions relative to the long-term performance of such a structure, particularly with the very thick laminates which will be required. Areas of particular concern include the following:

- o The strictly elastic nature of GRP raises questions as to the acceptability of its life-cycle notch sensitivity and fatigue strength in a highly loaded, highly redundant structure such as a ship's hull.
- o The potential flexibility of a GRP hull may aggravate problems with notch sensitivity, bond strength, and vibrations.
- o Lack of data raises concern relative to long-term strength retention, abrasion and impact resistance, fire retardancy, strength retention at higher temperatures, notch sensitivity and bond strength of GRP.
- o The relatively low strength of secondary bonds and the present lack of consistent results in their fabrication is a major concern. This may represent a significant weak link in the GRP structural chain, possibly requiring the use of mechanical fasteners.

On the basis of the foregoing, it is possible to design and fabricate a large GRP ship within the present state-of-the-art. However, the performance of the very thick laminates required and the necessary joints and connections have not been sufficiently proven in service or in the laboratory. Until sufficient experience is gained in the performance of such laminates, the over-all feasibility of a 500 foot GRP cargo ship cannot be confirmed. The required data can come only from extensive laboratory testing supplemented by service experience in craft sizes intermediate between the 100 foot range now going into service and the 500 foot ship contemplated.

III. DESIGN CRITERIA

The development of acceptable design criteria for the hull structure of a GRP cargo ship represents one of the most challenging and important considerations in this study. These criteria are fundamental in developing a technically feasible design, and require a thorough evaluation of the empirical and theoretical considerations leading to the steel scantlings presently required by regulatory bodies.

Design criteria have been developed for the primary hull girder structure and secondary midship structure to the extent necessary to demonstrate technical feasibility, including the following:

- o Hull girder section modulus at midships.
- o Primary hull structure: decks, tank top, shell plating and framing, longitudinal floors and girders, center vertical keel.

In general, the proposed criteria are based upon the conversion of existing steel scantlings to GRP on the basis of relative strength or stiffness ratios, as applicable. Where such procedures are deficient, allowable stresses and design loads are proposed to facilitate the required stress analysis.

EXISTING CRITERIA

As a prelude to developing design criteria for a GRP cargo ship, a review was made of existing criteria and procedures for developing GRP structures for commercial and naval vessels. There are presently four regulatory bodies with rules for the selection of materials, scantlings and quality assurance procedures for GRP vessels up to approximately 130 feet in length, References (27) through (30). In addition the American Bureau of Shipping is currently developing requirements for the design and construction of GRP yachts, trawlers and workboats up to 120 feet in length. In general, the regulatory body rules published to date have been based on the experience gained with GRP yachts and fishing trawlers over the past twenty years and as such cannot be extrapolated to the design criteria for a 500 foot GRP cargo ship.

In its feasibility studies of GRP minesweepers, the U.S. Navy developed design criteria for GRP vessels up to 189 feet in length, Reference (7). However, the special operational requirements of a Navy combatant ship preclude the direct application of the same design loads and safety factors to a commercial GRP cargo ship.

PROPOSED CRITERIA - MIDSHIP SECTION HULL GIRDER SECTION MODULUS

The required section modulus of the hull girder at midships for steel merchant vessels has traditionally been determined on the basis of balancing the vessel statically on a trochoidal wave and equating the resultant wave bending moment to an allowable stress. This stress, generally around 8 tons per square inch, was arrived at empirically, based upon the successful performance of many previous designs. During the last decade, rapid growth

in the size and number of super tankers and large bulk carriers has prompted the regulatory agencies to reconsider their requirements for hull girder strength. This has been possible because of recent developments in the science of oceanography and sea spectrum analysis, which have made it possible to predict life-cycle hull girder stress patterns with acceptable accuracy, and to relate these to the fatigue characteristics of the material.

The state-of-the-art in hull girder stress analysis has not yet advanced to the point where a truly classical structural design is possible. At this time, the process of hull design is essentially one of working backwards, comparing proven, acceptable scantlings with more sophisticated load inputs and resulting moments and shears to determine the range of safety factors which have provided satisfactory designs in the past.

Based upon the above limitations, it will be necessary to determine the GRP hull section modulus on the basis of converting acceptable steel scantlings, maintaining equivalent safety factors. In this process, the following factors apply:

- o Steel Hull SM - For this study, the baseline steel hull girder section modulus will be based on the midship section of the SS JAMES LYKES. The midship section scantlings will not be updated to conform to 1971 ABS rules, since the as-built scantlings are assumed to substantially conform to present ABS requirements. From these required scantlings an effective steel midship section will be determined by taking into account the allowance for corrosion.
- o Corrosion Allowance - Present data indicates that GRP laminates will not experience any reduction in thickness when exposed to a marine environment for twenty years or more. For the equivalent steel hull, the corrosion anticipated by ABS can be derived from the allowance which they permit for steel protected by an approved corrosion control system, such as inorganic coatings. This allowance is 10 per cent or 1/8 inch, whichever is less, for the exposed side shell and deck plating. It is noted that the ABS equations for converting mild steel to HTS steel consider corrosion allowances of .12 inch for tank top, deep tank and double bottom girder plating, and .17 inch for exposed shell and deck plating. Since these latter values are deducted from the mild steel scantlings prior to conversion and are then added back to the HTS, it is slightly conservative to apply the higher allowances in converting from MS to HTS. However, where an allowance is being deducted from steel which will not be added back to the GRP scantlings, the 1/8 inch or 10 per cent allowance is more appropriate. Therefore, in converting from steel to GRP, an "effective" steel midship section will be derived by deducting 1/8 inch or 10 per cent from bottom and side shell and exposed deck plate. A lesser allowance of 1/16 inch will be deducted from all other longitudinally effective structure.
- o Short-Term Static Loading - In considering short-term static loading, it is desirable that the GRP and steel hulls have the same safety factor when experiencing the maximum combination of wave and still water bending moments. For a constant hull girder bending moment, this can be expressed by the relationship in Equation (1):

$$\text{Equation (1): Hull SM}_{\text{GRP}} = \text{Hull SM}_{\text{Steel}} (\text{effective}) \\ \times \frac{65000}{F_u} \times 1.60$$

Where F_u is the short term tensile or compressive ultimate strength of the laminate, whichever is less.

The factor of 1.60 is an additional margin of safety to account for the following factors:

Loss in strength of GRP due to moisture absorption.

Variability in thickness.

Greater variability from assumed average mechanical properties than with steel.

Loss of the inherent safety factor in steel construction afforded by plastic response following yielding of the material.

Unknown notch sensitivity and fracture toughness characteristics relative to steel. This is of particular importance since most structural failures in steel vessels originate at an area of stress concentration.

Greater loss in strength for relatively limited cyclic loading. As shown in Figure 3, the ultimate strength retention at 10^3 cycles is only about 60 per cent of that of steel.

Greater tendency toward creep and stress rupture failure than with steel.

Each factor or group of factors was assigned a coefficient approximately proportional to its adverse affect on the ultimate tensile or compressive strength of the GRP laminate, relative to steel, as shown in Table 8. The coefficients for wet strength reduction and variability of physical properties and laminate thickness were selected on the basis of industry averages, while the coefficients for non-yielding characteristics, unknown notch sensitivity and fracture toughness characteristics, etc., were based on engineering judgment pending development of necessary data from tests.

TABLE 8
SAFETY FACTOR COEFFICIENTS - GRP LAMINATES

<u>Item</u>	<u>Coefficient</u>
Wet strength reduction	1.10
Variability in material properties or laminate thickness	1.20
Non-yielding characteristics	1.10
Notch sensitivity and other factors	1.10

The factor of 1.60 is somewhat arbitrary and must be based upon conservative engineering judgment where valid quantitative data is lacking. In subsequent studies, the sensitivity of vessel life cycle cost to changes in this factor will be evaluated, thereby providing insight into the potential economic worth of research needed to refine it.

- o Long-Term Loading - Long-term loading implies consideration of the anticipated stress levels which the hull will experience throughout its life, in conjunction with the low cycle fatigue strength of the hull material. The relationship between steel and GRP is similar to that developed for short-term static loading except for an additional safety factor as shown in Equation (2):

$$\text{Equation (2): Hull SM}_{\text{GRP}} = \text{Hull SM}_{\text{Steel}} (\text{effective}) \\ \times \frac{65000}{F_u} \times 1.60 \times 1.20$$

Where F_u and the 1.60 safety factor are as noted previously for Equation (1).

The additional 1.20 factor of safety represents the ratio of areas under the S-N curves of mild steel and typical GRP laminates, Figure 3, between 1 and 10^8 cycles. This range corresponds to the anticipated maximum range of life cycle tensile or compressive bending stresses.

- o Hull Girder Moment of Inertia - It appears obvious that the hull girder stiffness of a GRP cargo ship must be less than that of its steel counterpart if it is to be economically feasible. Since there is no regulatory body guidance as to the extent to which the hull girder deflection can be increased over that of a steel ship, it is proposed that initially no limitation be imposed in order to determine what deflection will result when normal strength considerations govern the selection of scantlings. The resultant deflection will be evaluated later.

PROPOSED CRITERIA - PRIMARY HULL STRUCTURE

In this section, criteria are proposed for converting ABS steel scantlings to GRP for application to the design of the primary hull structure of a GRP cargo ship. In the event that the structural configuration is not conducive to a straightforward conversion of plate thickness or stiffener section modulus, alternate design criteria based on design loads and safety factors are presented. The following structural elements are considered:

- o Bottom Shell Plate and Framing
- o Side Shell Plate and Framing
- o Main Deck Plate and Framing
- o Upper Tween Deck Plate and Framing
- o Tank Top Plate and Framing
- o Inner Bottom Floor and Girder Plates
- o Other Hull Framing Members

In general, these criteria will establish minimum scantlings to resist combinations of primary and secondary stresses, local loads, impact, abrasion, slamming, etc., with consideration given to vibration and buckling problems. It will often be necessary to increase these minimum scantlings to suit hull section modulus requirements.

Design Criteria for Plates

In general, the approach to converting steel plate thicknesses to equivalent GRP thicknesses requires the derivation of an "effective" steel thickness by deducting all corrosion allowances, then increasing this thickness by a function of the relative strength ratios, and adding back any required allowances for abrasion or other factors.

The corrosion allowance to be deducted from steel will depend upon its anticipated exposure to salt water. An allowance of 1/8 inch or 10 per cent of the thickness, whichever is less, is proposed for the hull envelope (deck, side and bottom plate) with a 1/16 inch allowance for the internal plates. If the Owner or regulatory bodies have added an additional margin for abrasion, such as on the flat of bottom or on the bottom of the hold, this should also be deducted.

The factor by which the "effective" thickness is to be modified is based upon the ratio of the ultimate tensile or compressive strengths of the materials as in Equation (1) previously. For plates loaded primarily in shear, tension or compression, the full ratio should be used. However, for plates which are loaded primarily in tertiary bending (bending between stiffeners due to applied normal load) the square root of this ratio should be used, since the section modulus of an element of plate is a function of (thickness)². For plates subjected to a combination of tertiary bending and tension, compression or shear, an average factor should be used.

The allowance for abrasion to be added back to the resultant GRP laminate thickness is somewhat arbitrary. However, the previous discussions of GRP laminate abrasion resistance indicates that GRP is not as abrasion resistant as metals. Thus, for equal life, the steel allowance should be multiplied by k, the wear rate of GRP laminates relative to steel. Since there is presently no known quantitative data on the relative wear rates of GRP laminates and steel, the approach to abrasion protection must be empirical or based upon future testing.

Summarizing the foregoing discussion, the conversion of mild steel plate thicknesses to GRP would be as shown in Equation (3):

$$\text{Equation (3): } t_{\text{GRP}} = (t_{\text{steel}} - C_1 - C_2) \left(\frac{65000}{F_u} \right)^n (1.60) + k C_2$$

Where:

- t_{GRP} = minimum required GRP thickness
- t_{steel} = steel thickness required by ABS Rules without correction for corrosion control or increases for hull girder section modulus requirements
- C_1 = corrosion allowance for mild steel
- C_2 = additional allowance for abrasion, if any
- k = wear rate of GRP relative to steel (to be determined)
- F_u = short term tensile or compressive ultimate strength of GRP
- n is an exponent based on type of loading. For axial and shear loads, $n = 1$. For normal loads, $n = 1/2$. For a combination of axial and normal loading, a value of $3/4$ is recommended.

Values of C_1 , C_2 and n are as shown in Table 9.

TABLE 9

COEFFICIENTS FOR DETERMINING GRP PLATE THICKNESS

<u>Item</u>	<u>C₁</u>	<u>C₂</u>	<u>n</u>
Minimum bottom thickness	1/8" or .10t	As required by Owner	1
Side plate	1/8" or .10t	0	1
Deck plate (exposed)	Determined primarily by hull girder SM requirements. Equation (3) not applicable.		
Tween deck plate	1/16"	As required by Owner	3/4
Tank top plate	1/16"	As required by Owner or ABS	3/4
Floors and girders	1/16"	0	1

A safety factor of 1.50 on the critical panel buckling strength is recommended. The 1.50 safety factor is higher than the 1.0 factor used for steel design, due to the variability in compressive modulus, laminate thickness, and wet strength. The panel buckling analysis can be based upon the primary hull bending stress without considering the additional stress from secondary bending of the plate-stiffener combination, since the latter is generally quite small.

Design Criteria for Stiffeners

The design procedure for converting mild steel stiffener scantlings to GRP consists of increasing the section modulus of the steel member by the relative strength ratio noted previously for plates:

$$\text{Equation (4): } SM_{\text{GRP}} = SM_{\text{Steel}} \times \frac{65000}{F_u} \times 1.50$$

Where F_u and the 1.50 safety factor are as noted previously for Equation (1).

Corrosion allowances are technically applicable to the above equation, but are neglected to provide an additional margin for member stiffness. The additional weight resulting from this simplification is negligible.

Stiffeners should be checked for column buckling strength under the effects of axial loads. It is suggested that the L/r ratio of the plate-stiffener combination be sufficiently low that the safety factor on column buckling failure would be 2.0. This value is higher than the 1.57 safety factor used for steel due to the factors noted above.

The deflection of GRP stiffeners and sandwich panels should be kept within reasonable limits, to minimize secondary bending problems at supports and to prevent damage to cargo stowed under decks and flats. However, it is difficult to establish a specific deflection limitation, since this is a somewhat arbitrary decision, with little technical justification. Until a valid technical foundation for such a limitation can be developed, it is proposed to limit the deflections of GRP stiffeners and sandwich panels to three times that of the equivalent steel section. This corresponds to approximately L/120, where L is the maximum unsupported span. Deflection limitations of this magnitude have proven satisfactory in designing small GRP craft, where the analysis is based upon maximum beam or panel loading.

ALTERNATE DESIGN CRITERIA

Where the structural configuration is not conducive to a straightforward conversion of plate thickness or stiffener section modulus, it is proposed that the structure be designed for the loads and safety factors shown in Table 10.

TABLE 10

DESIGN LOADS AND SAFETY FACTORS - GRP HULL STRUCTURE

<u>Item</u>	<u>Normal Head or Load</u>	<u>Axial Load (Tens. or Compr.)</u>	<u>Safety Factors</u>		<u>Deflection</u>
			<u>Bending/Axial</u>	<u>Buckling</u>	
Bottom shell	Hydrostatic head to Main Deck	Long'l bending stress	↑ 5.0 on ult. strength for transverse struct., 5.0 for longitudinal struct. ↓	↑ 2.0 on column buckling 1.5 on panel buckling ↓	L/100
Side shell	Hydrostatic head to Main Deck	Long'l bending stress			L/100
Main Deck	7.5 foot hydrostatic head	Long'l bending stress			L/100
Upper Tween Deck	44.8#/Ft ² per foot of deck height	Long'l bending stress			L/100
Tank Top - Cond. 1	Hydrostatic head 3'-0" above Main Deck	None			L/100
Tank Top - Cond. 2	44.8#/Ft ² per foot of deck height	Long'l bending stress			L/100
Floors & Girders	Hydrostatic head to Main Deck	Long'l bending stress			L/100

In general the safety factors and deflection limitations proposed in Table 10 correspond to those previously developed for plate panels and stiffeners. With the 1.60 factor applied to GRP for the items noted previously, these safety factors are equivalent to a design stress of 8.0 and 9.0 tons per square inch for longitudinal and transverse steel structure respectively.

The safety factors proposed in Table 10 are somewhat higher than the factor of 4.0 applied to the primary hull structure of present GRP displacement craft such as yachts, trawlers and minesweepers. This reflects greater concern for the effects of fatigue and higher hull girder loading on large ships.

IV. DESIGN OF GRP CARGO SHIP

In this phase of the study, a hypothetical GRP cargo ship is developed which is essentially identical to the SS JAMES LYKES. This includes the following tasks:

- o Selection of principal dimensions.
- o Design of GRP midship section.
- o Determination of hull girder deflection.
- o Estimated light ship weight.
- o Determination of trim and stability.

SELECTION OF PRINCIPAL DIMENSIONS

The principal dimensions of the GRP cargo ship will be identical to those of the SS JAMES LYKES, as delineated in Table 1. The GRP cargo ship is assumed to be identical in full load displacement, with the reduction in light ship weight used to increase the cargo deadweight, and thus the earning capacity. The anticipated increase in available cargo deadweight is 1447 tons or 17 per cent, which means that the existing cargo hold dimensions would be unsatisfactory for all but weight-critical cargoes. For a new design, the hold volume could be increased accordingly. However, for this study, the volume of the cargo holds for the steel and GRP ships will be kept identical to permit direct comparison, although the cargo stowage factor will be higher for the GRP vessel.

All hull dimensions and form coefficients of the two ships are to be identical, so that speed-power relationships at full load displacement are similar. This means that the power plants of the two ships will be identical, thereby eliminating costs associated with the machinery system as variables.

It is recognized that this approach, although satisfactory for a feasibility study, will not necessarily result in an optimum GRP hull. A preliminary design study to develop an optimum GRP cargo ship with the same full load displacement and cargo stowage factor as the SS JAMES LYKES could result in a vessel whose hull dimensions and form characteristics are different, which would preclude direct comparison. The reduction in hull weight without a corresponding reduction in the machinery and outfit weights will result in greater trim in some loading conditions. However, these refinements can easily be incorporated in the design if desired, but should be excluded from this feasibility study so that direct basis is maintained for comparing the two designs.

DESIGN OF GRP MIDSHIP SECTION

Structural Configuration. The basic configuration of the GRP midship section shown in Figure 5 is dimensionally similar to the steel ship, Figure 2. It is proposed to use single skin and frames construction for the shell and double bottom, with sandwich panel construction for the decks. The

reason for this choice is primarily economic. For the shell, it would appear that sandwich construction would be very expensive due to curvature and the need for vacuum bag molding to achieve satisfactory core bond strength and laminate properties.

For the decks, where deflections are critical, the use of single skin and frames construction would require transverse beams with depths in excess of the present steel beams. Since reduced headroom is undesirable, the best method of achieving required stiffness appears to be sandwich construction. Since these decks are relatively flat, layup with vacuum pressure or other forms of pressure would be less expensive than on the shell.

The hatchside girders and pillars are to be steel, since stiffness requirements preclude the economic use of GRP. These girders must be discontinuous at bulkheads so that they do not act in conjunction with the hull in resisting longitudinal bending loads, which would overstress them.

The double bottom is to be of corrugated single skin construction, both to provide a structurally rigid bottom grillage and to limit shell and inner bottom panel widths. Alternatively, filament-wound box girders could be used.

It is recognized that the question of hull configuration requires far greater investigation before the foregoing assumptions can be fully justified. For this particular study, however, these assumptions can be accepted, since longitudinal strength considerations dictate much of the laminate thickness, and the cost of providing this large mass of material overshadows the potential cost differential which would be achieved by further optimization of the midship structural configuration. It is sufficient to state at this time that the most economical method of construction consistent with strength and stiffness requirements will be used in subsequent design studies of GRP cargo vessels.

Laminate Configurations. This study is based upon a composite laminate of unidirectional rovings and woven roving as proposed in Section II, which appears to have a proper balance between warp and fill strength for this application.

Two alternative laminate configurations have been given consideration.

The first alternative utilized woven roving laminate throughout the hull.

A second alternative midship section was developed utilizing the composite reinforced laminate in highly stressed deck and bottom areas and the all woven roving reinforced laminate in the area near the neutral axis. However, preliminary analysis indicated that the area in which the all woven roving reinforced laminate could be used would be too small to warrant its use. Therefore this concept was dropped from further consideration.

Composite Reinforced Laminate Midship Section. Scantlings for the unidirectional/woven roving laminate composite midship section are shown in Figure 5 based upon the following development:

- o Initially, the scantlings of those structural components whose configurations corresponded to the equivalent steel section are determined on the basis of direct conversion from steel to GRP using the equations given in Section III. Minimum GRP scantlings

for the bottom, bilge, side shell and tank top plating, sheer strake and flat plate keel are determined in this manner.

- o The scantlings thus developed are checked to ascertain whether they satisfy the compressive buckling criteria for GRP given in Section III.
- o For those GRP components whose configurations are substantially different from the equivalent steel components, scantlings are developed based on the criteria shown in Table 10. The corrugated inner bottom structure, upper tween deck and main deck are designed in this manner.
- o Scantlings of the deck and bottom structure are increased as needed to satisfy the long term hull girder section modulus requirements of Section III.

The transverse hold and tween deck frames maintain the 30 inch spacing of the steel ship and are designed by direct conversion of plate-stiffener section moduli from steel to GRP. Hat sections are used with an effective GRP plating width of 30 inches.

All Woven Roving Midship Section. The GRP midship section utilizing all woven roving is quite similar in configuration to that for the composite GRP laminate, Figure 5. However, the scantlings would be substantially heavier, since the compressive ultimate strength of woven roving is only about one-third that of the composite laminate.

Evaluation. Table 11 summarizes the strength, stiffness and weight characteristics of the steel and GRP midship sections. As indicated therein, the weight saving per foot of the composite laminate hull relative to the steel ship is approximately 43 per cent with the inclusion of steel hatch side girders, while the woven roving section weighs slightly more than the steel section. The EI ratio of the GRP composite and woven roving section to steel is only 20 and 34 per cent of that of the steel ship, respectively, resulting in hull girder deflections being increased substantially. The question of excessive hull girder deflections will be discussed in greater detail later. It is noted that the section moduli to the keel shown in Table 11 for the GRP hulls are slightly greater than the required value, reflecting the effects of the panel buckling requirements on single skin laminates.

Based upon the foregoing evaluation, it is concluded that the woven roving GRP section will not provide the hull weight saving relative to steel which is required to justify its higher cost. For this reason, no further consideration will be given to the all-woven roving GRP hull.

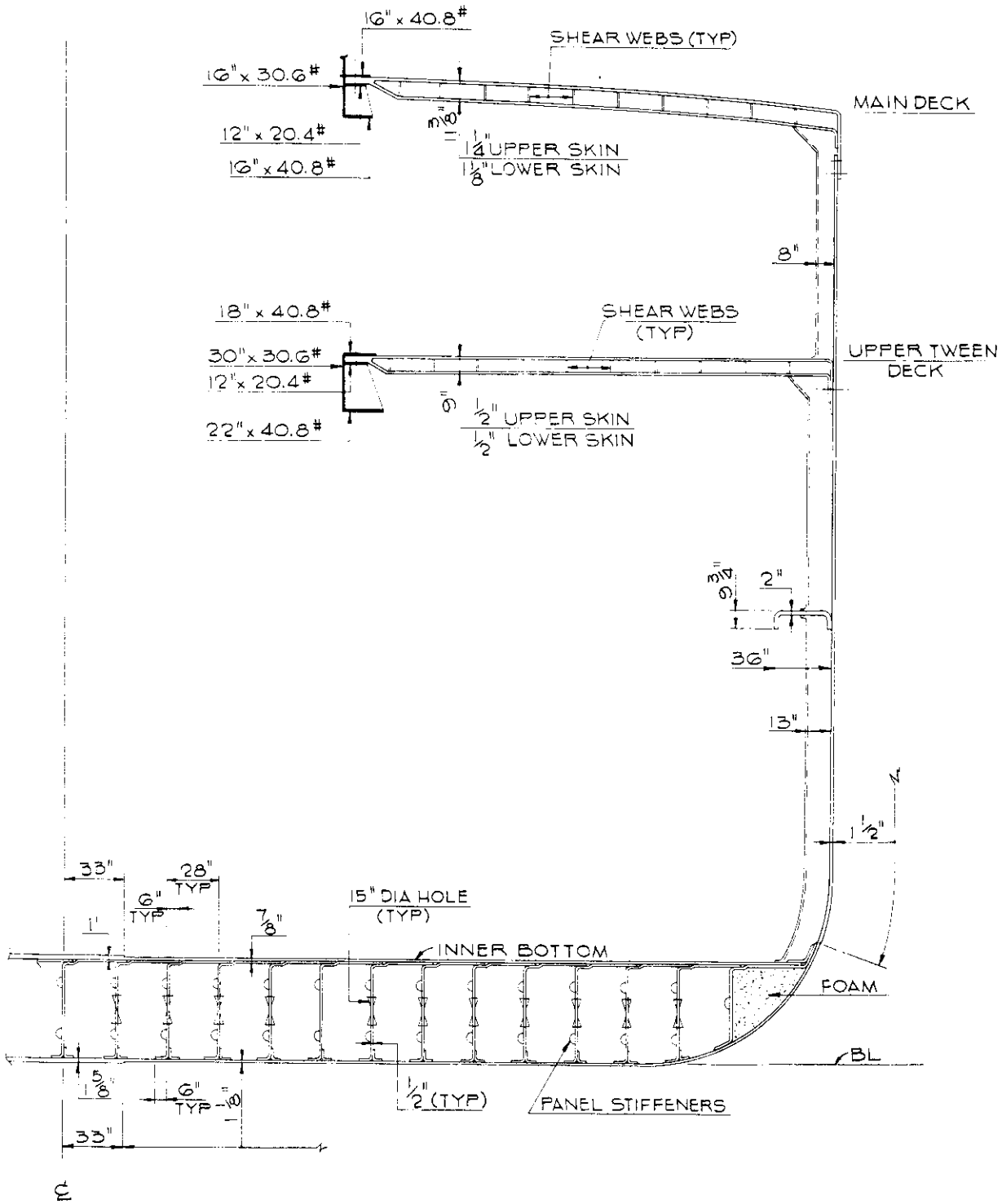

FIGURE 5

MIDSHIP SECTION - COMPOSITE LAMINATE GRP CONSTRUCTION

TABLE 11

COMPARISON OF STEEL AND GRP MIDSHIP SECTIONS

Item	Steel Figure 2	GRP	
		All Woven Roving Laminate	Woven Roving Uni- directional Composite Laminate - Figure 5
Weight per foot ^(a) , tons	5.88	6.18 ^(b)	3.33 ^(b)
Weight/foot relative to steel	-	1.03	0.57
Section Modulus (Deck) in ² ft	31,755 ^(c)	198,986	68,575
Section Modulus (Bottom) in ² ft	42,091 ^(c)	208,191	84,724
Minimum SM relative to steel	-	6.27	2.16
Moment of inertia, in ² ft ²	752,584 ^(c)	4,230,440	1,575,864
EI, in ² ft ²	22.58 x 10 ¹²	7.61 x 10 ¹²	4.57 x 10 ¹²
EI, relative to steel	-	0.34	0.20

(a) Includes transverse structure.

(b) Includes steel hatchside girder.

(c) Based on "effective" thicknesses, after deduction of appropriate corrosion allowances.

HULL GIRDER DEFLECTION

With a modulus of elasticity only one-tenth to one-twentieth that of steel, one of the major problems of GRP construction is excessive hull girder deflection. As shown in Table 11, the deflection of the GRP hulls constructed of unidirectional/woven roving composite laminate is 5 times that of the equivalent steel ship. The findings of the aluminum bulk carrier study, Reference (25), indicate that hull girder deflections of up to 1.5 times that of steel are acceptable and should cause no problems in the areas of shafting, piping or other system runs, hatch cover tightness, hull response to sea-induced loads, or hull vibrations. A detailed discussion of these factors can be found in Reference (25). Without further study, it appears reasonable to extrapolate the conclusion of Reference (25) to a factor of 2. However, the much larger deflections of the GRP hulls cannot be accepted without a major investigation, which is beyond the scope of the present study. Because of the large deflection noted, there does not appear to be any justification for refining the conservative design criteria proposed in order to reduce scantlings, since this would result in still further increases in hull girder deflection.

The problem of GRP hull girder deflection involves two factors: reducing deflections as much as possible, and designing the ship and its system to accept larger deflections than those now generally accepted.

For a new design, hull girder deflections can be limited by judicious selection of hull form, scantlings, cargo and light ship weight distribution, and ballast arrangement. Reduction in the still water bending stresses will minimize the effects of hull girder deflections on full load draft. Excessive still water deflection can limit cargo carrying capacity both for freeboard requirements and for limiting drafts requirements entering harbors or crossing sandbars, thus adversely affecting the economic potential of the GRP vessel.

Areas which should be considered in selecting the characteristics of a new GRP cargo ship design to reduce deflection include the following:

- o Increasing the depth and beam while reducing hull length. The maximum practical extent to which such changes could be made would be based upon speed-power considerations and stability.
- o Adding high modulus unidirectional GRP material to the hull girder deck and bottom, to increase hull stiffness.
- o Careful review of arrangements to achieve a weight distribution minimizing hull girder bending moments in all operating conditions.

These factors were not applied to this study in designing the GRP equivalent to the SS JAMES LYKES, since changes to hull dimensions, arrangements or an arbitrary increase in hull girder inertia would prevent a direct comparison with the steel ship. However, a new design would surely recognize these factors.

Despite the best efforts of the designer to minimize hull girder deflection by the methods noted previously, it can be assumed that the deflections of a GRP cargo ship will be higher than those of steel ships of similar size. These larger deflections must be accepted, since further increases in stiffness will have an unacceptable effect on the economics of the GRP ship. Among the key factors to be considered are the following:

- o Propulsion shafting. The machinery should be as far aft as possible to minimize shaft deflections and bearing reactions, though this may result in undesirable weight distributions.
- o Low modulus piping such as GRP or PVC should be used wherever possible, as noted in Section II. Where long longitudinal runs of steel or copper-nickel piping are required, expansion loops should be provided.
- o Hull girder frequency spectra should be carefully compared to propulsion system RPM and propeller characteristics to avoid undesirable resonances.
- o Hatch cover gasketing and dogging systems must accommodate greater relative deflections yet maintain tightness.

LIGHT SHIP WEIGHT ESTIMATE

The light ship weight estimate for the steel ship is shown in Table 12, based upon data from the building yards. These weights are applicable to the steel vessel as built with an assumed life of 20 years.

TABLE 12

LIGHT SHIP WEIGHT ESTIMATE - STEEL CONSTRUCTION

	<u>Weight Long Tons</u>	<u>VCG Feet</u>	<u>Vert. Momt., Ft. Tons</u>	<u>LCG Feet</u>	<u>Long'l Momt., Ft. Tons</u>
Steel	3,394	26.34	89,398	10.9 A	36,885 A
Equipment and Outfit	1,610	41.93	67,508	16.6 A	26,726 A
Machinery	<u>782</u>	<u>24.34</u>	<u>19,026</u>	<u>101.3 A</u>	<u>79,206 A</u>
Light Ship	5,786	30.41	175,932	24.7 A	142,817 A

Light ship weight estimates for the GRP hull are obtained by applying appropriate conversion factors to the steel ship weight estimate. The vertical and longitudinal centers of gravity are assumed to be identical to the steel ship. Coefficients for converting the hull structure and the equipment and outfit weights of the steel ship for an equivalent GRP ship are shown in Tables 13 and 14. The total machinery weight for the GRP hull is assumed to be the same as that of the steel ship. Light ship weights for the GRP equivalent to the SS JAMES LYKES are summarized in Table 15.

It should be noted that the conversion factors in Tables 13 and 14 reflect engineering judgment based on previous studies and assumptions as to the percentage of items included in the original group weight breakdown which would be affected by the conversion between steel and GRP. An additional 5 per cent of the total hull structural weight was added for the GRP hulls as an approximation of the weight of bonding angles and overlaps.

A review of Tables 12 and 15 indicate that the light ship weight of the composite laminate GRP cargo ship will be about 0.75 times that of an equivalent steel ship. The vertical center of gravity of the GRP ship is more than a foot higher than that of the steel ship. This results from the weight savings in the hull structure being of a lower center of gravity than that of the ship as a whole. A higher VCG for GRP ships can be expected as long as the large reduction in hull structural weight is not matched by a corresponding reduction in the weight of equipment and outfit.

TABLE 13

WEIGHT REDUCTION COEFFICIENTS - HULL STRUCTURE

<u>Item</u>	<u>Weight^(a) Steel (Long Tons)</u>	<u>Sub-Division</u>	<u>Weight Steel (Long Tons)</u>	<u>Reduction Coefficients for GRP</u>
Shell Plating	796.3	Midbody 60%	477.8	0.57 ^(b)
		Ends 40%	318.5	0.50
Framing	543.3	Midbody 60%	325.0	0.57 ^(b)
		Ends 40%	217.3	0.50
Forging & Castings	52.5	All	52.5	0.50
Decks (Plating & Beams)	712.6	Midbody 70%	498.8	0.57 ^(b)
		Ends 30%	213.8	0.50
Bulkheads & Trunks	350.8	All	350.8	0.60
Pillars & Girders	154.1	All	154.1	1.00
Foundations	63.2	All	63.2	1.00
Superstructure	380.6	All	380.6	0.50
Miscellaneous	226.4	All	226.4	0.75

(a) Steel weights obtained from shipyard weight estimates.

(b) Reduction coefficients equal to the respective ratios of the weight per foot of the GRP midship sections to that of steel (Table 11).

TABLE 14

WEIGHT REDUCTION COEFFICIENTS - OUTFIT

<u>Item</u>	<u>Weight (a) Steel Ship (Long Tons)</u>	<u>Reduction Coefficients for GRP</u>
Struct. Steel in Outfit	377.8	1.00
Hull Attachments	141.6	1.00
Lights, Doors, Hatches	15.3	0.60
Carpenter Work & Decking	93.4	1.00
Joiner Work	120.8	1.00
Deck Outfit	176.4	.25 for Paint 1.00 for Other Items
Stewards Outfit	12.0	1.00
Hull Engineering	269.4	1.00
Piping	153.6	0.70
Misc. Machy.	249.9	1.00

(a) Weights for steel ship obtained from shipyard weight estimates

TABLE 15

LIGHT SHIP WEIGHT ESTIMATE - COMPOSITE GRP CONSTRUCTION

	<u>Weight Long Tons</u>	<u>VCG Feet</u>	<u>Vertical Moment Ft. Tons</u>	<u>LCG Feet</u>	<u>Longitudinal Moment Ft. Tons</u>
Hull Structure	2,034	25.74	52,364	10.5 A	21,400 A
Outfit	1,524	43.20	65,811	16.1 A	24,592 A
Machinery	<u>782</u>	<u>24.34</u>	<u>19,026</u>	<u>101.3 A</u>	<u>79,206 A</u>
Light Ship	4,339	31.62	137,201	28.9 A	125,198 A

TRIM AND STABILITY

A check of stability and trim was made for the full load departure and half load, half consumables conditions. The results of these studies are shown in Tables 16 and 17, which are based upon the assumption that the reduction in light ship is available for additional cargo.

In the full load condition the stability of the GRP ship is slightly better than that of the steel ship, since the VCG of the added cargo is lower than the VCG of the reduction in structural weight. Trim by the bow has increased appreciably, but this could be corrected in a new design by proper placement of tanks.

In the half cargo, half consumables condition, the stability is also improved, as is the trim.

In summary, the use of GRP in lieu of steel for the hull structure of a cargo vessel will not degrade stability or create trim problems in any normal loading condition. In extremely light conditions, the quantity of ballast required to suit stability requirements will be greater than for the steel ship, but to total displacement will be less.

TABLE 16

TRIM AND STABILITY - FULL LOAD DEPARTURE CONDITION

	<u>Steel Ship</u>			<u>GRP Ship</u>		
	<u>WT</u>	<u>VCG</u>	<u>LCG</u>	<u>WT</u>	<u>VCG</u>	<u>LCG</u>
Light Ship	5,786	30.41'	24.7' A	4,339	31.62'	28.9' A
Crew & Misc DWT	52	45.17'	51.5' A	52	45.17'	51.5' A
Fuel	2,000	7.22'	24.53' A	2,000	7.22'	24.53' A
FW	226	20.08'	71.61' A	226	20.08'	71.61' A
Cargo	8,500	21.49'	10.30' F	9,947	21.49'	10.30' F
Displacement	16,564	22.94'	7.44' A	16,564	22.48'	5.48' A
Draft at LCF	29'-1-3/4"			29'-1-3/4"		
KM	28.30'			28.30'		
KG	22.94'			22.48'		
GM	5.36'			5.82'		
FS	0.41'			0.41'		
GM _{Corr}	4.95'			5.41'		
GM _{Reqd}	1.00'			1.00'		
Margin	3.95'			4.41'		
LCB	7.73' A			7.73' A		
LCG	7.44' A			5.48' A		
LVR	.29' F			2.25' F		
MT ¹	1,388 Ft.Tons			1,388 Ft.Tons		
Trim	3-1/2" by Bow			26-7/8" by Bow		
Draft Fwd	29'-3-3/4"			30'-4-1/4"		
Draft Aft	29'-0-1/4"			28'-1-3/8"		

TABLE 17

TRIM AND STABILITY - 1/2 CONSUMABLES, 1/2 CARGO

	<u>Steel Ship</u>			<u>GRP Ship</u>		
	<u>WT</u> <u>L. Tons</u>	<u>VCG, Ft.</u>	<u>LCG, Ft.</u>	<u>WT</u> <u>L. Tons</u>	<u>VCG, Ft.</u>	<u>LCG, Ft.</u>
Light Ship	5,786	30.41'	24.7' A	4,339	31.62'	28.9' A
Crew & Stores	47	45.31'	51.81' A	47	45.31'	51.8' A
Fuel	1,000	3.90'	26.15' A	1,000	3.90'	26.15' A
FW	113	20.01'	70.74' A	113	20.01'	70.74' A
Cargo	4,250	21.49'	10.3' F	4,974	21.49'	10.3' F
SW Ballast ^(a)	213	17.8'	191.4' F	213	17.8'	191.4' F
Displacement	11,409	24.48'	8.32' A	10,686	23.97'	6.55' A
Draft at LCF		21'-3"			20'-0-3/4"	
KM		27.81'			28.03'	
KG		24.48'			23.97'	
GM		3.33'			4.06'	
FS Correction		0.59'			0.63'	
GM Corrected		2.74'			3.43'	
GM Required		2.05'			2.38'	
Margin		0.69'			1.05'	
LCB		4.76' A			4.45' A	
LCG		8.32' A			6.55' A	
LVR		3.56' A			2.10' A	
MT1"		1,085 Ft. Tons			1,059 Ft. Tons	
Trim		37-1/2" by Stern			21-1/8" by Stern	
Draft Fwd		19'-7-1/2"			19'-1-3/4"	
Draft Aft		22'-9"			20'-10-7/8"	

(a) Ballast added in clean ballast tank for trim only

V. COST STUDIES

OBJECTIVES

The objective of these studies was to compare the life cycle costs of an existing steel cargo ship with a GRP ship of the same over-all dimensions to determine if the higher first cost of the GRP ship can be justified on the basis of long term economics, including extended ship life.

CONSTRUCTION COST ESTIMATES

The initial investment cost of the unidirectional/woven roving composite GRP hull was obtained by first estimating the initial cost of the SS JAMES LYKES for construction in a United States shipyard in 1970. Subsequently the cost of the steel cargo ship was divided into components which were adjusted to reflect an equivalent construction cost for the GRP ship. All costs were initially determined on the basis of a five ship procurement and a vessel life of 20 years. Subsequently, the cost estimates were modified to reflect procurements of one and ten ships and a vessel life of 30 years.

Cost Estimate of Steel Cargo Ship. The cost of the steel ship at 1970 price levels was based on the total 1957 construction cost (low bid price plus cost adjustments) for each of five ships, Reference (31), upgraded to 1970 price levels by means of the Index of Estimated Shipbuilding Costs in the United States, Reference (31). Comparisons with other estimating procedures led to the conclusion that a valid 1970 level price for a steel ship similar to the SS JAMES LYKES would be approximately \$13,500,000. The construction cost breakdown shown in Table 18 was computed using relative cost ratios for hull, machinery and outfit developed from the shipyard's Construction Progress and/or Payment Report (CPPR) and an assumed profit margin of 10 per cent. General costs, including engineering, are contained in the hull, machinery and outfit costs.

TABLE 18

ESTIMATED COST^(a) OF STEEL CARGO SHIP

Hull Structure	\$ 2,790,000
Outfit	6,200,000
Machinery	<u>3,290,000</u>
Subtotal	\$12,280,000
Profit (10%)	<u>1,220,000</u>
Total Construction Cost Per Ship	\$13,500,000

(a) Cost is for each ship of a 5-ship procurement

To estimate accurately the effects of GRP on the construction costs of the vessel, the cost groups shown in Table 18 were divided into approximately

75 subgroups by means of the shipyard's Construction Progress and/or Payment Report (CPPR). The CPPR divides the total contract price of the ship into 10,000 points and assigns these points to various components of the ship or the shipbuilding process in proportion to the component's assumed cost. By dividing the total CPPR points into the dollar price of the steel ship (exclusive of profit) from Table 18, an average dollar value per point was derived. Knowing the average cost per point, the individual costs of the subgroups were computed.

Cost Per Foot of GRP Midship Section. The cost criteria used to estimate the cost per foot of the composite GRP midship section structure are as follows:

- o Costs were estimated for each ship of a five ship procurement.
- o Total glass content for the composite laminate is 55 per cent by weight. The glass weight per square yard is 24 ounce for woven roving, 18 ounce for unidirectional material. Thus, woven roving comprises 60 per cent of total glass content, unidirectional material 40 per cent.
- o Core material was assumed to be 2 Lb/Ft³ polyurethane foam since it is non-structural.
- o 1970 level material costs were assumed as follows:

Steel	\$ 0.09/lb
Woven roving reinforcement	0.50/lb
Unidirectional reinforcement	0.62/lb
Polyester resin (general purpose)	0.20/lb
Polyurethane foam	1.50/lb

A 10 per cent margin was added to the total material cost for scrap.

- o Since precise information concerning labor productivity is not known, it was decided to assume a range of three values, which may be thought of as pessimistic, average and optimistic: 15 lb/MH, 30 lb/MH and 45 lb/MH, respectively, for a five ship procurement. The wage rate was assumed to be \$3.00 per hour.
- o Overhead was assumed to be 150 per cent of direct labor cost.
- o An allowance of 15 per cent was added to the material, labor and overhead costs to amortize non-recurrent facility modifications.
- o Profit was assumed to be 10 per cent of material, labor and overhead.
- o The tooling cost per pound was obtained by dividing the tooling costs discussed later, and shown in Table 22 for each ship of a five ship procurement, by the total hull structure weight from Table 13. Knowing the tooling cost per pound and the weight per foot of the midship section, Table 11, the tooling cost per foot was determined.

The cost per foot of the midship section is based on its estimated weight per foot given in Table 11. A summary of the results appears in Table 19 and includes figures for selling price per foot and selling price per pound, both with and without the cost of tooling.

Tooling Costs. In order to approximate tooling costs, the proposed molding arrangement shown in Figure 4 was used. Total tooling costs for each ship are comprised of the initial cost of constructing the molds divided by the number of hulls laid up, plus recurring labor costs associated with setting up and dismantling the molds for each ship.

Cost of Hull Mold. The hull mold was assumed to be constructed of mild steel plate of light scantlings (3/8 inch - 1/2 inch) supported by trusswork. The weight of the structure was assumed to be about equal to the combined steel weight of the shell, framing and end forgings of the SS JAMES LYKES, or 1390 long tons. The cost per pound of mold was assumed to be \$0.60, including materials, labor, overhead and profit. This resulted in a direct cost of the hull mold of \$1,870,000. An additional \$430,000 has been added for site preparation in way of the mold, resulting in a total hull tooling cost of \$2,300,000, including profit, which would be distributed among the total number of ships fabricated.

Cost of Deck Molds. The average deck area of the main and upper tween decks is 17,430 square feet. Since the smallest hatch opening is 25 x 18 feet, the maximum allowable size for the deck mold sections cannot exceed these dimensions to permit passing them up through the hatches to lay up the next higher deck. This means an average of 40 such sections would be needed to lay up one deck. It is assumed that each section is of steel, weighs 20 pounds per square foot, and costs \$0.30/lb. This results in a total cost for 40 sections of \$108,000, which would also be divided among the total number of ships built. Additional framework supports will increase the deck tooling cost to about \$150,000, including profit.

Labor Costs - Hull Mold. The total cost of moving and unbolting the mold for each hull was assumed to be 1000 manhours at \$12/Hr., including labor, overhead and profit, or \$12,000 for each ship.

Labor Costs - Deck Molds. It was assumed that 30 manhours at \$12/Hr. would be required to install and remove each form from each of the decks. This results in a labor cost of \$30,000 per ship.

Scaffolding. Erection and dismantling of scaffolding within the mold was assumed to require 2000 manhours at \$12/Hr., or \$24,000 for each ship.

A 10 per cent margin was added to the costs given above to cover contingencies and the deckhouse tooling. The foregoing analysis resulted in a fixed tooling cost of \$2,700,000, which is equally distributed among the total number of ships constructed, plus \$72,600 per ship in direct labor.

General Costs. General costs include expenditures for such items as plans and engineering, mold lofting, staging and erection, checking and expediting, cleaning, launching and trials. The costs were computed by taking the point values of items for steel from the CPPR, times a cost coefficient for GRP construction, times the average dollar value per point. The resultant contribution to the contract price was assumed constant for each ship in a given flight. The cost figure was adjusted for flights of 1, 5 and 10 ships.

For each of five GRP ships the general costs were determined to be \$1,121,200, without profit.

Hull Structure Costs for Each of Five GRP Ships. The cost of shell plating and framing, innerbottom structure, bulkheads, stanchions, decks, bow and stern assemblies, and superstructure decks and bulkheads were calculated by taking the hull structure weight, Table 13, minus the weight of foundations, times the cost per pound of the midship structure (without tooling and profit) for pessimistic, average and optimistic labor production rates, Table 19. The cost of additional hull structure items were obtained by upgrading the corresponding steel costs as follows:

- o Foundations and ladders were assumed to be primarily of steel construction. The cost of these items was assumed to be 1.25 times the comparable steel cost, or \$227,200. This differential accounts for the greater difficulty of installation.
- o Costs for materials and fabrication of steel masts, king posts and booms for the GRP ship were assumed to equal the comparable costs for the steel ship, or \$127,700 and \$86,000, respectively. Mast erection was assumed to be twice that of steel, or \$54,000.

TABLE 19
ESTIMATED COSTS ^(a) OF GRP MIDSHIP SECTION STRUCTURE

	<u>Pessimistic Rate</u>	<u>Average Rate</u>	<u>Optimistic Rate</u>
Material	\$3,135	\$3,135	\$3,135
Labor	1,492	746	497
Overhead	<u>2,238</u>	<u>1,119</u>	<u>746</u>
Subtotal	\$6,865	\$5,000	\$4,378
Facility Amortization 15%	1,030	750	657
Profit 10%	687	500	438
Tooling	<u>970</u>	<u>970</u>	<u>970</u>
Selling Price per Foot (with Tooling)	\$9,552	\$7,220	\$6,443
Selling Price per Foot (without Tooling)	<u>\$8,582</u>	<u>\$6,250</u>	<u>\$5,473</u>
Selling Price per Pound (with Tooling)	\$ 1.28	\$ 0.97	\$ 0.86
Selling Price per Pound (without Tooling)	\$ 1.15	\$0.84	\$ 0.73
Cost per Pound (without Tooling or Profit)	\$ 1.06	\$ 0.77	\$ 0.68

(a) Costs are for each of a five ship procurement.

o Hull testing was assumed to be 1.25 times the steel cost, or \$62,900.

The steel costs were obtained from the CPPR for each ship of a five ship procurement. A summary of the hull structure costs is shown in Table 20.

TABLE 20

HULL STRUCTURE COSTS FOR EACH OF FIVE GRP SHIPS

	<u>Pessimistic Rate</u>	<u>Average Rate</u>	<u>Optimistic Rate</u>
Foundations and Ladders	\$ 227,200	\$ 227,200	\$ 227,200
Masts, King Post and Booms			
Materials (Steel)	127,700	127,700	127,700
Fabrication	86,000	86,000	86,000
Erection	54,000	54,000	54,000
Hull Testing	<u>62,900</u>	<u>62,900</u>	<u>62,900</u>
Subtotal	\$ 557,800	\$ 557,800	\$ 557,800
GRP Structure	<u>4,672,300</u>	<u>3,394,100</u>	<u>2,997,400</u>
Total Cost (Without Profit)	\$5,230,100	\$3,951,900	\$3,555,200

Outfit and Equipment Costs for Each of Five GRP Ships. It was assumed that, except for the adjustments which will be mentioned directly, the costs for outfit and equipment would be equal for materials and 1.25 times the labor cost for the steel ship. Again the costs for the steel ship were based on the assigned points from the CPPR times the average dollar value per point for outfit and equipment. An additional \$40,000 was added for extra fire fighting equipment and two-thirds of the initial cost of painting the steel ship, or \$217,800 was deducted. This gave a total Outfit and Equipment Cost of \$6,293,500, without profit, for construction of five identical hulls.

Machinery Costs for Each of Five GRP Ships. As noted previously, the power plant of the GRP ship was assumed to be identical to that for the steel ship. The cost of the machinery for the GRP ship was assumed to be \$500,000 greater than the corresponding steel ship cost, to account for greater installation costs. Accordingly, the total GRP machinery cost was \$3,790,000 excluding profit.

Variable Levels of Procurement. In addition to obtaining the acquisition costs for each of five steel and GRP ships, the costs of building a single ship and each of a ten ship procurement were determined. This was accomplished by adjusting the estimated cost of hull structure, outfit and machinery by 1.18 and 0.92 for one and ten ships respectively. These multiple ship cost coefficients were obtained by averaging the values given in References (32) and (33). The costs of tooling and the non-recurring components of general costs were redistributed for one and ten ships.

Total Construction Cost Estimates. The range of estimated construction costs for steel and GRP cargo ships in flights of 1, 5 and 10 ships and a ship life of twenty years is shown in Tables 21 and 22, respectively, and graphically in Figure 6. No margin for contingencies or risk has been added to the cost of the GRP ship, though these would undoubtedly affect the procurement costs for the first group of large GRP hulls, as discussed later.

TABLE 21

CONSTRUCTION COST ESTIMATE SUMMARY
STEEL CARGO VESSEL - 20 YEAR LIFE

	<u>1 Ship</u>	<u>5 Ships</u>	<u>10 Ships</u>
Hull Structure	\$ 3,292,000	\$ 2,790,000	\$ 2,567,000
Outfit	7,316,000	6,200,000	5,704,000
Machinery	<u>3,882,000</u>	<u>3,290,000</u>	<u>3,027,000</u>
Subtotal	\$14,490,000	\$12,280,000	\$11,298,000
Profit (10%)	<u>1,449,000</u>	<u>1,220,000</u>	<u>1,130,000</u>
Total	\$15,939,000	\$13,500,000	\$12,428,000

Figure 6 indicates that for the procurement of five or ten GRP hulls, the cost differential between a GRP and steel cargo vessel will vary from 2.8 to 5.2 million dollars, depending upon the assumed labor productivity in fabricating the GRP hull. For a single ship procurement the cost differential will vary from 6.8 to 9.0 million dollars.

TABLE 22

CONSTRUCTION COST ESTIMATE SUMMARY - GRP CARGO VESSEL

	<u>1 Ship</u>	<u>5 Ships</u>	<u>10 Ships</u>
<u>Pessimistic Rate</u>			
Hull Structure(a)	\$ 6,171,500	\$ 5,230,100	\$ 4,811,700
Outfit	7,426,300	6,293,500	5,790,000
Machinery(b)	4,472,200	3,790,000	3,486,800
General	<u>2,034,800</u>	<u>1,121,200</u>	<u>1,007,000</u>
Subtotal	\$20,104,800	\$16,434,800	\$15,095,500
Profit (10%)	2,010,500	1,643,500	1,509,600
Tooling	<u>2,772,600</u>	<u>612,600</u>	<u>342,600</u>
TOTAL	\$24,887,900	\$18,690,900	\$16,947,700
<u>Average Rate</u>			
Hull Structure(a)	\$ 4,663,200	\$ 3,951,900	\$ 3,635,700
Outfit	7,426,300	6,293,500	5,790,000
Machinery(b)	4,472,200	3,790,000	3,486,800
General	<u>2,034,800</u>	<u>1,121,200</u>	<u>1,007,000</u>
Subtotal	\$18,596,500	\$15,156,600	\$13,919,500
Profit (10%)	1,859,700	1,515,700	1,392,000
Tooling	<u>2,772,600</u>	<u>612,600</u>	<u>342,600</u>
TOTAL	\$23,228,800	\$17,284,900	\$15,654,100
<u>Optimistic Rate</u>			
Hull Structure(a)	\$ 4,195,100	\$ 3,555,200	\$ 3,270,800
Outfit	7,426,300	6,293,500	5,790,000
Machinery(b)	4,472,200	3,790,000	3,486,800
General	<u>2,034,800</u>	<u>1,121,200</u>	<u>1,007,000</u>
Subtotal	\$18,128,400	\$14,759,900	\$13,554,600
Profit (10%)	1,812,800	1,476,000	1,355,500
Tooling	<u>2,772,600</u>	<u>612,600</u>	<u>342,600</u>
TOTAL	\$22,713,800	\$16,848,500	\$15,252,700

(a) Composite unidirectional/woven roving laminate used throughout.

(b) Machinery plant of GRP vessel identical to steel ship.

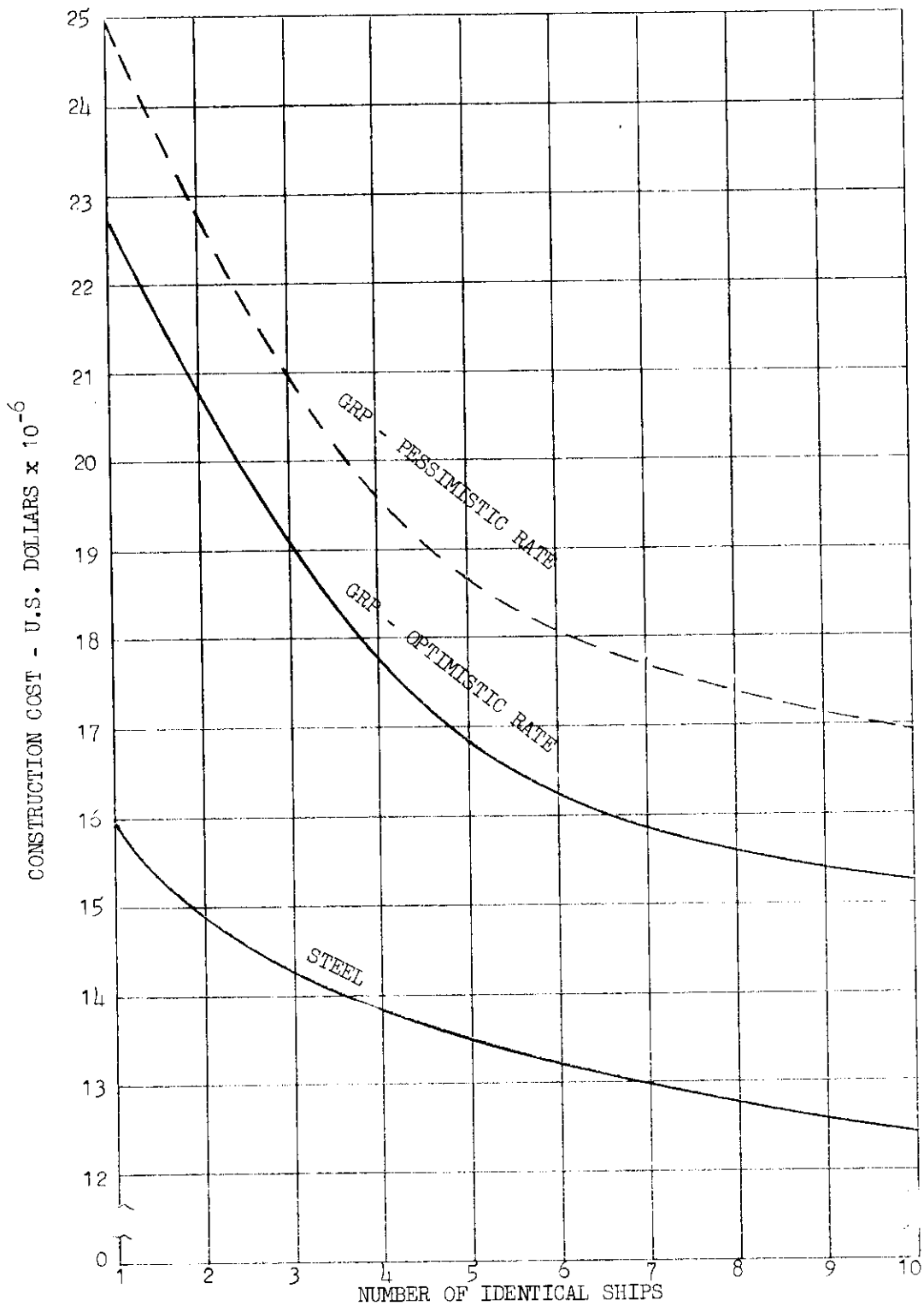

FIGURE 6

CONSTRUCTION COST ESTIMATES - STEEL AND GRP CARGO VESSELS

The question of contingencies was addressed earlier and requires further consideration. Within the constraints of this study, which relate to construction of GRP cargo ships in the immediate future, it can be assumed that the response of the shipbuilding industry will be somewhat pessimistic, since this proposal represents a major departure from conventional shipyard practices, and would involve retraining, introduction of new skills, modifications to physical facilities and a significant learning effort on the part of labor, engineering and management. Unless there is a significant incentive associated with the GRP cargo ship program, either financial or in terms of future work, few if any major U.S. shipyards may be interested. Thus, it must be assumed that the procurement costs of the first flight of GRP cargo ships will be higher than shown in Figure 6, because of contingencies and risk being incorporated in the bid. The size of this factor is difficult to evaluate, but it could be significant since the competition between shipyards will probably not be keen.

On this basis, it must be assumed that the foregoing acquisition cost estimates are optimistic and would not be achievable until the feasibility of a GRP cargo ship has been fully demonstrated by the construction of a prototype. Such a prototype would undoubtedly cost far more than the \$23 - 25,000,000 estimated for a single GRP ship procurement based on assumed available shipyard capability.

Variable Life Spans. The procurement costs for GRP and steel vessels with lives in excess of 20 years were increased from the baseline figures in Tables 21 and 22 as follows:

- o The GRP hull structure was assumed to be satisfactory for a 30 year life without modification.

- o The steel hull structure was assumed to be satisfactory for a life of 25 years without plate renewal, based upon discussions with American Bureau of Shipping. Two methods are therefore open to extend the hull life to 30 years: provide greater plate thickness initially so that the net plate thickness at 30 years is marginally satisfactory, or renew excessively corroded plate at 25 years. The first approach was chosen, and one-sixteenth inch was added to the immersed shell plating throughout and to selected areas of the Main Deck, and upper side shell, which would extend the shell life 5 years, based on an average corrosion rate of .01 inches per year. This was assumed to increase the light ship weight 75 tons, with a corresponding increase in cost and reduction in available deadweight for weight critical cargoes. It is assumed that the use of inorganic zincs or equal in conjunction with a reasonable maintenance program will prevent excessive corrosion of the plating. The additional steel and improved corrosion protection were estimated to add \$75,000 to the initial price of each ship of a five ship procurement with a twenty year life. It is interesting to note that a recent audiogauge survey of the shell and main deck plating of a vessel of the SS JAMES LYKES Class indicated that after ten years of service the corrosion rate was substantially below the .01 inches per year allowance, except in certain localized areas. Thus, the above assumptions are considered realistic.

- o Procurement costs for machinery and outfit were assumed identical for 20 and 30 year lives, since they do not directly affect the qualitative results of the study. In reality however, it is obvious that the cost of equipment with a 30 year life will be higher than for a 20 year life, in most cases, unless a more rigorous life cycle maintenance program is utilized.

LIFE CYCLE ECONOMIC STUDIES

Approach. In order to determine the life cycle economic benefits, if any, of the GRP ship, a study was made comparing the steel ship and the GRP ship operating in a hypothetical trade. The structural weightsaving inherent to GRP was assumed to be translated into increased cargo capacity, hence greater revenue. Since revenue varied between alternate designs, the Required Freight Rate (RFR) was used as the economic measure of merit. The alternative with the lowest RFR is the more economically attractive.

It is noted that for scheduled cargo-liner operations, an economic model based on the comparison of individual ships rather than on the over-all transportation system is not completely realistic. The size and number of ships, the availability of cargo, the flexibility of schedules, and so forth, are important variables in the selection of an optimum cargo-liner system. However, due to the limited scope of this study, it has been assumed that these additional factors can be eliminated without affecting the final conclusions regarding the relative economic benefits of steel and GRP construction.

Economic Criteria. The measure of merit used for this study was Required Freight Rate (RFR), since revenues are unknown and vary between alternatives. The Required Freight Rate is the income per unit of cargo that must be collected in order to earn returns equivalent to the repayment of the initial investment at a specified rate of interest. RFR is equal to the Average Annual Cost (AAC) divided by the annual cargo transported. The total average annual cost is equal to the average annual cost of operation plus the annual cost of capital recovery as follows:

$$AAC = Y + \frac{CRF}{i} P$$

where: Y = Annual direct costs (wages, repairs, fuel, insurance, etc.)

CRF = Before-tax capital recovery factor. The capital recovery factor transforms the investment (P) into equivalent annual amounts (R) which will recapture the investment (P) in n years, at an interest rate (i).

P = Investment = the total initial price of the ship.

Financial Assumptions. The Owner's initial investment was assumed to be 25 per cent of the initial ship cost; the remainder to be borrowed from a bank at 8 per cent annual interest. The loan period was assumed equal to the life of the ship, with payments in annual installments. Additional assumptions included an after tax return to the Owner of 10 per cent on the total investment, a 48 per cent tax rate, straight-line depreciation over the life of the ship, no investment tax credit and no consideration of inflation or subsidies.

The before-tax capital recovery factor (CRF) was computed using Equations 16 and 17, Reference (34), as follows:

$$CRF = \frac{CRF' \frac{n}{i} - \frac{t}{n} - t \frac{I_B}{P}}{1 - t}$$

where: CRF = Capital recovery factor before tax.
 CRF' = Capital recovery factor after tax.
 i = Yield, or after-tax interest rate = 10%.
 n = Life span of ship = 20 or 30 years.
 t = Tax rate = 48%.
 P = Total initial investment.
 I_B = Annual interest payment to bank.
 $= \frac{CRF' n}{i} - \frac{1}{n} P_B$, where i_B is the annual interest rate stipulated by the bank at 8%.
 P_B = capital borrowed from bank or 0.75 P.

For life spans of twenty and thirty years CRF equaled 0.14395 and 0.13487, respectively.

Voyage Assumptions. For the purpose of estimating costs the following voyage assumptions were made:

- o Operation in trans-Atlantic liner trade.
- o Average round-trip voyage of 28 days (16 days at sea, 12 days in port).
- o Twelve round-trip voyages per year for a total of 336 operating days per year.
- o Total of a 194 sea days per year (scheduled voyages plus trips to and from the shipyard for overhaul).
- o Total of a 160 port days per year (scheduled voyages plus an allowance for delays, in port repairs, and overhaul).
- o An over-all utilization factor of 70 per cent of the available cargo deadweight was assumed for both the steel and GRP ship. Due to volume limitations or the unavailability of cargo, an additional utilization factor of 50 per cent was applied to the increased deadweight made available by the reduced hull structural weight of the GRP ship. The effects of eliminating this 50 per cent factor

on RFR are evaluated later. The effective cargo deadweight of the GRP ship was estimated as follows:

$$\text{Effect. Cargo Dwt. GRP} = .7 (8500^{(a)}) + .5 (4339^{(b)}) - \text{Light Ship GRP}$$

(a) Maximum cargo deadweight of the steel SS JAMES LYKES.

(b) Light ship weight of the steel SS JAMES LYKES, Table 12.

Operating and Maintenance Cost Assumptions. The assumptions used to estimate the fixed and variable operating and maintenance costs applicable to the steel and GRP ships are as follows:

- o All costs for U.S. flag operation.
- o Operating expenses were assumed to be unsubsidized.
- o Annual crew wage rates are estimated by proportioning figure given in Reference (25). Wage rates for both the steel and GRP ships = \$979,900 per year including vacation, overtime, pension and welfare, social security and training, assuming identical crew size. It may be feasible to reduce the crew size on a GRP ship due to reduced topside maintenance, though this would require reevaluation of present manning level requirements and labor agreements.
- o Subsistence cost = \$40,500 per year, proportioned from Reference (25).
- o Stores and Supplies = \$50,600, proportioned from Reference (25).
- o Overhead and miscellaneous cost equal to \$50,000 and \$20,000, respectively, per Reference (25).
- o Insurance costs per year for both ships were estimated using the formulas in Reference (33) updated to 1970 insurance rates:
 - Hull and Machinery = \$10,000 + 0.01 (acquisition cost for a one ship procurement)
 - Protection and Indemnity = \$800 (Crew Size + Gross Tonnage/1000)
= \$44,100
 - War Risk = .001 (acquisition cost for a one ship procurement)
- o Fuel costs for the steel ship were estimated at \$188,700 for 194 sea days and 160 port days per year. For the steel and GRP ships operating at the same speed, a 10 per cent reduction in power requirements over the life of the GRP ship was assumed due to the decreased light ship weight when not fully utilized for additional cargo, and smoother hull surface. The resultant fuel savings was estimated to be \$15,000 per year.
- o Annual maintenance and repair costs exclusive of costs related to the builder's guarantee, betterments, insurance claims and work performed

by the crew were determined from data based on an average of seven years service for ships of the SS JAMES LYKES Class, Reference (35). Actual steel ship maintenance and repair costs for hull, machinery and outfit averaged \$22,800, \$25,400 and \$31,000, respectively, for a yearly cost of \$80,400. For a twenty year life span the total annual M&R cost for the steel ship was assumed to average \$100,000. Equivalent annual M&R costs for the GRP ship were difficult to estimate due to lack of experience with GRP hulls of this size. Therefore, it was assumed that the average M&R cost of the GRP ship will be identical to that for the steel ship since any savings inherent to GRP construction will be overshadowed by the following considerations:

The maintenance costs for machinery and equipment will be identical for steel and GRP ships.

Bottom painting requirements for steel and GRP will be essentially the same.

To cover scratches, gouges and abrasions, the remainder of the GRP hull structure will be periodically painted.

Life cycle uninsured repairs to the GRP ship may be more expensive than the equivalent repairs in steel, including plate renewal.

The first large GRP ships will undoubtedly be required to have more special surveys than an equivalent steel ship.

The average annual cost of maintenance and repair for both the steel and GRP ships with a life span of thirty years was assumed to be 50 per cent greater than the M&R costs for twenty years. This assumption reflects the accelerated rate of maintenance and repair during the additional ten years of service and assumes that major plate renewal for the steel ship will not be required due to additional plate thickness provided initially. Since the cost of M&R is less than 5 per cent of the total average annual cost, any error in M&R due to the assumptions above will have negligible effect on the RFR.

- o Salvage was assumed to be a negative cost. The salvage value of the steel ship after twenty and thirty years was arbitrarily assumed to be \$100,000 and \$50,000, respectively. Applying capital recovery and present worth factors gave an equivalent annual (negative) cost of \$2,700 and \$500 for ship lives of twenty and thirty years respectively. Since a GRP hull cannot be rendered into any reusable material, the salvage value of the equipment was assumed offset by the cost of disposing of the hull. Thus, there is no salvage value for the GRP hulls.
- o Port and cargo handling costs were assumed equal for all alternatives and omitted from the cost studies.

Summary. The average annual cost and RFR for the proposed GRP cargo ship in flights of one, five and ten ships and ship life of 20 and 30 years are compared to the equivalent steel ships in Table 23 and Figures 7 and 8. Table 23 indicates that regardless of the vessel life, level of procurement and fabrication rate the Required Freight Rate (RFR) of the GRP ship will be greater than for the equivalent steel ship. Although there is substantial saving in hull weight, the higher first cost of the GRP ship cannot be fully compensated for by increased cargo deadweight or reduced fuel consumption.

The RFR differential between a GRP and steel vessel varies from \$0.59 to \$6.68 per ton. The actual differences in RFR will be greater, since the GRP acquisition costs do not reflect contingencies and risk as discussed previously. It is noted that absolute rather than percentage differences are used in comparing equivalent RFRs since up to 35 per cent of the total average annual cost, mostly in cargo handling, port and brokerage expenses, have been neglected in this study.

SENSITIVITY STUDIES

The foregoing economic studies were based upon a fixed set of criteria, both for ship cost and operational considerations. This phase of the study investigates the possible effects on the life cycle cost estimates of varying these factors, to determine which has the greatest effect on profitability and thus deserves greatest attention in future studies of this nature.

Seven sensitivity studies were conducted as follows:

o Study A - Factors of Safety

Reduce the 1.60 factor of safety in Equations 1 and 2, Section III, to 1.30.

Reduce the 1.20 fatigue factor in Equation 2, Section III, to 1.10.

Reduce the 1.50 safety factor on the critical panel buckling strength, Section III, to 1.25.

Reduce the 1.60 factor of safety for plate panels and stiffeners, Equations 3 and 4, Section III, to 1.30.

o Study B - Weight Reduction Coefficients

Reduce the weight reduction coefficients for bulkheads and trunks, foundations, and miscellaneous structure, Table 13, from 0.60, 1.0 and 1.0 to 0.50, 0.75 and 0.50 respectively.

Reduce the weight reduction coefficients for structural steel in outfit, hull attachments, carpenter work and decking, joiner work, stewards outfit, hull engineering and miscellaneous machinery, Table 14, from 1.0 to 0.75.

TABLE 23

SUMMARY OF LIFE CYCLE COSTS FOR STEEL AND GRP CARGO SHIP

Line No.	No. of Ships	Item	20 YEAR LIFE			30 YEAR LIFE		
			Steel	GRP		Steel	GRP	
				Low Cost	High Cost		Low Cost	High Cost
1		Vessel Expense/Yr.						
2		Wages	\$ 979,900	\$ 979,900	\$ 979,900	\$ 979,900	\$ 979,900	\$ 979,900
3		Subsistence	40,500	40,500	40,500	40,500	40,500	40,500
4		Stores and Supplies	50,600	50,600	50,600	50,600	50,600	50,600
5		Fuel (including port fuel)	188,700	173,700	173,000	188,700	173,700	173,700
6		Maintenance and Repair	100,000	100,000	100,000	150,000	150,000	150,000
7		Insurance	229,500	304,000	327,900	230,400	304,000	327,900
8		TOTAL Vessel Expense	\$1,589,200	\$1,548,700	\$1,671,900	\$1,640,100	\$1,598,700	\$1,722,500
9		Owner's Expense/Yr.						
10		Salvage	\$ -2,700	0	0	\$ -500	0	0
11		Overhead	50,000	50,000	50,000	50,000	50,000	50,000
12		Miscellaneous	20,000	20,000	20,000	20,000	20,000	20,000
13		SUBTOTAL Owner's Expense	\$ 67,300	\$ 70,000	\$ 70,000	\$ 69,500	\$ 70,000	\$ 70,000
14	↑ 1 Ship	Owner's Expense/Yr. (Cont'd)						
15		Cost of Capital Recovery	\$2,294,800	\$3,269,700	\$3,582,600	\$2,161,600	\$3,063,400	\$3,356,600
16		TOTAL Owner's Expense = 13 + 15	\$2,362,100	\$3,339,700	\$3,652,600	\$2,231,100	\$3,133,400	\$3,426,600
17		TOTAL Average Annual Cost = 8 + 16	\$3,951,300	\$4,988,400	\$5,324,500	\$3,871,200	\$4,832,100	\$5,149,200
18		Annual Cargo Carried (Long Tons)	142,800	155,000	155,000	141,500	155,000	155,000
19	↓	Required Freight Rate = 17 ÷ 18	\$27.67/ton	\$32.18/ton	\$34.35/ton	\$27.36/ton	\$31.17/ton	\$33.22/ton
20	↑ Each of 5 Ships	Owner's Expense/Yr. (Cont'd)						
21		Cost of Capital Recovery	\$1,943,300	\$2,425,300	\$2,690,600	\$1,830,900	\$2,272,400	\$2,520,800
22		TOTAL Owner's Expense = 13 + 21	\$2,010,600	\$2,495,300	\$2,760,600	\$1,900,400	\$2,342,400	\$2,590,800
23		TOTAL Average Annual Cost = 8 + 22	\$3,599,800	\$4,144,000	\$4,432,500	\$3,540,500	\$4,041,100	\$4,313,400
24		Annual Cargo Carried (Long Tons)	142,800	155,000	155,000	141,500	155,000	155,000
25	↓	Required Freight Rate = 23 ÷ 24	\$25.21/ton	\$26.74/ton	\$28.60/ton	\$25.02/ton	\$26.07/ton	\$27.83/ton
26	↑ Each of 10 Ships	Owner's Expense/Yr. (Cont'd)						
27		Cost of Capital Recovery	\$1,789,200	\$2,195,600	\$2,439,600	\$1,685,500	\$2,057,100	\$2,285,700
28		TOTAL Owner's Expense = 13 + 27	\$1,856,500	\$2,265,600	\$2,509,600	\$1,755,000	\$2,127,100	\$2,355,700
29		TOTAL Average Annual Cost = 8 + 28	\$3,445,700	\$3,914,300	\$4,181,500	\$3,395,100	\$3,825,800	\$4,078,300
30		Annual Cargo Carried (Long Tons)	142,800	155,000	155,000	141,500	155,000	155,000
31	↓	Required Freight Rate = 29 ÷ 30	\$24.13/ton	\$25.25/ton	\$26.98/ton	\$23.99/ton	\$24.68/ton	\$26.31/ton

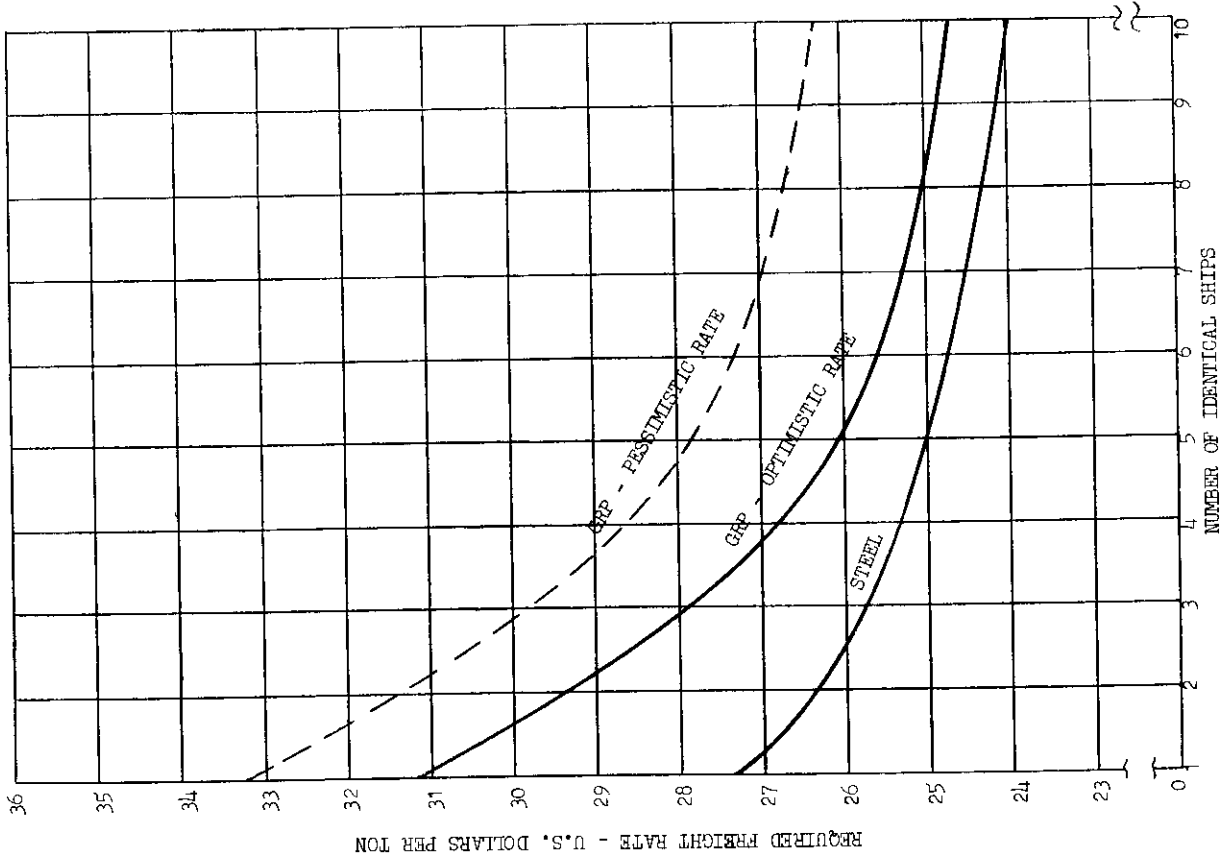

FIGURE 8 - REQUIRED FREIGHT RATE - STEEL AND GRP CARGO VESSELS -- 30 YEAR LIFE

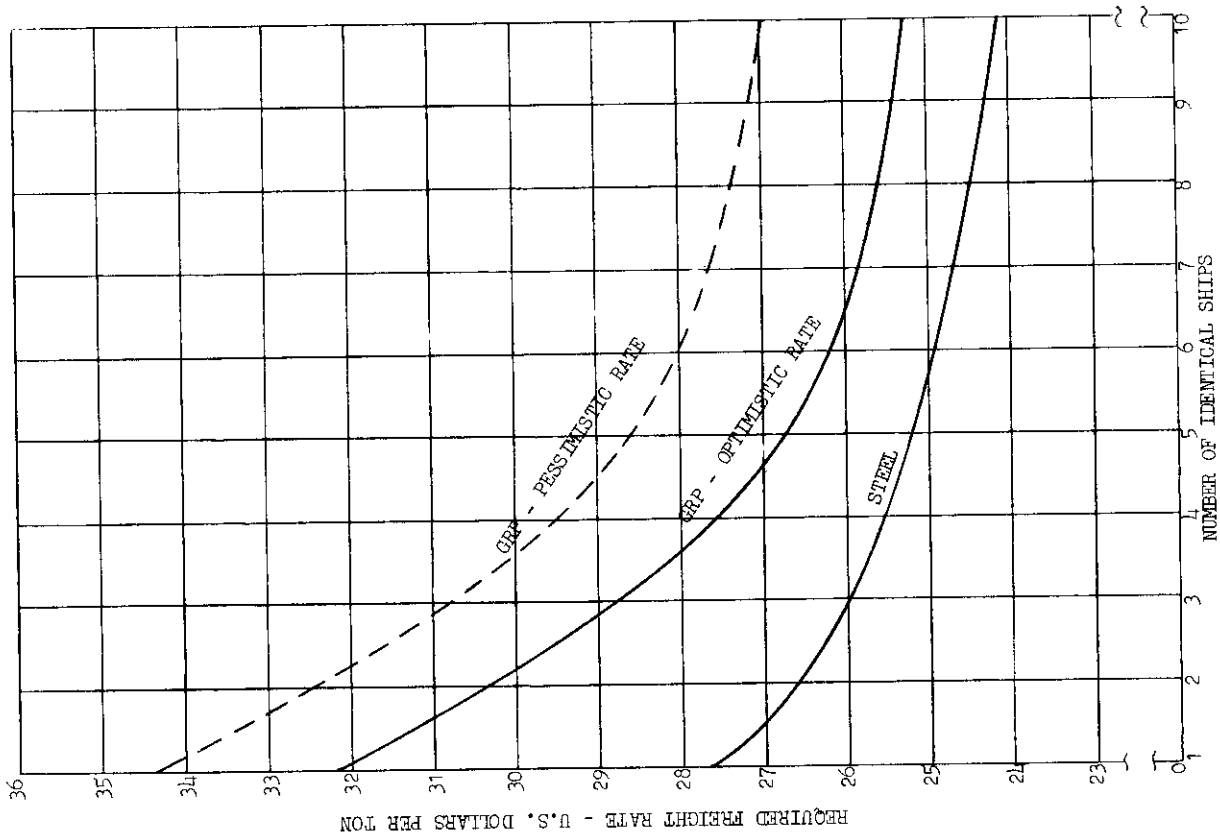

FIGURE 7 - REQUIRED FREIGHT RATE - STEEL AND GRP CARGO VESSELS -- 20 YEAR LIFE

o Study C - Costing Criteria for Main Structure

Modify the criteria used to estimate the cost per foot of midship section as follows:

Reduce the scrap allowance from 10 to 5 per cent.

Reduce the overhead allowance from 150 to 125 per cent of direct labor.

Delete the 15 per cent allowance for facility amortization.

o Study D - Costing Criteria for Tooling and Specific Subsystems

Reduce the total tooling cost per ship by one third.

Reduce the cost coefficient for foundations and ladders from 1.25 to 1.00.

Reduce the cost coefficient for mast erection from 2.0 to 1.5.

Reduce the \$500,000 allowance for installing the machinery plant in the GRP hull to \$250,000.

o Study E - Combination

Combine Studies A through D.

o Study F - Fire-Retardant Resins

Substitute fire-retardant resin for the general purpose resin used in the analysis of the baseline GRP hull.

o Study G - Deadweight Utilization

Increase the utilization factor of the additional cargo deadweight made available because of the reduced light ship weight of GRP construction from 0.50 to 1.0.

All the sensitivity studies assume a five ship procurement and a thirty year vessel life.

Summary of Results. A summary of light ship weights, construction costs and life cycle costs for sensitivities studies A through G are presented in Tables 24, 25 and 26. These results indicate that the use of more optimistic design and cost analysis criteria can, in some cases, make the GRP ship marginally competitive with the equivalent steel ship, for a procurement of five or more ships. The conclusions of the individual studies are as follows:

- o Study A - The use of more optimistic design criteria resulted in a 68 ton or 3 per cent savings in the hull structure weight of the baseline GRP ship. Although the weight reduction corresponded to an average \$0.25 reduction in RFR, the RFR of the GRP ship is still \$0.81 to \$2.55 per ton higher than the equivalent steel ship. It is noted that any reduction in scantlings will increase the already large hull girder deflections of the GRP vessel.

- o Study B - Reduced weight reduction coefficients for selected hull structural and outfit items resulted in a 429 ton or 10 per cent reduction in total light ship weight of the GRP ship. For the case of optimistic labor rates, the \$1.5 million reduction in construction costs resulted in a RFR a \$1.08 per ton less than the RFR of the equivalent steel ship.
- o Study C - Modification of the criteria used to estimate the cost per foot of midship section of the GRP ship resulted in a construction cost savings of \$0.5 million and \$1.0 million for optimistic and pessimistic labor rates respectively. These cost savings were not sufficient to make the RFR of the GRP ship competitive with that for steel.
- o Study D - The reduction in tooling, machinery and selected hull structure and outfit costs resulted in a construction cost savings of approximately \$500,000 for the GRP vessel. While reducing the RFR of the baseline GRP ship by \$0.57, the cost savings were not sufficient to make the GRP ship competitive with steel.
- o Study E - Combining the modified design and cost analysis criteria of Sensitivity Studies A through D resulted in a 498 ton or 11.5 per cent reduction in light ship weight and a \$2.9 million to \$3.4 million savings in construction cost for the optimistic and pessimistic labor rates respectively. The corresponding RFRs for the low and high cost options were \$2.38 and \$1.15 lower than for the steel ship, respectively. Study E indicates that the GRP ship is marginally competitive with steel. It is important to note that no allowance for contingencies has been added and that the technical feasibility of realizing all of the optimistic design and cost analysis criteria has not been proven.
- o Study F - The use of fire-retardant resin in the construction of all hull structure components resulted in an increased hull structure weight of 100 tons or 5 per cent. Total construction costs increased approximately \$400,000 to \$500,000 with a resultant increase in the RFR of the baseline GRP ship of \$0.50 and \$0.60 per ton for the low and high labor production rates respectively. The analysis of Study F assumed the use of fire-retardant resin throughout the laminate. However, for thick laminates, such as used for the bottom, side shell and main deck plating, limiting the use of the fire-retardant resin to the surface of the laminate should be investigated. The annual insurance cost used in Study F does not reflect the reduced level of risk commensurate with the use of fire-retardant resin. Reduced insurance cost will help to offset the higher initial cost of the fire-retardant vessel.
- o Study G - Increasing the utilization factor of the additional cargo deadweight made available by the reduced light ship weight of GRP construction reduced the RFR of the baseline GRP ship \$1.87 and \$2.02 per ton for the low and high cost option respectively. As shown in Table 26 the RFR of the low cost GRP ship is competitive with the equivalent steel ship. As Study G indicates, the full economic benefit of the reduced structural weight of GRP construction can only be realized when there is an unlimited quantity of weight critical cargo available, which will allow the vessel to sail fully loaded at all times.

TABLE 24
SUMMARY OF SENSITIVITY STUDIES A AND B

Line No.	Item	Study A Factors of Safety		Study B Weight Reduction	
		Low Cost	High Cost	Low Cost	High Cost
1	Light Ship Weight				
2	Hull Structure	1,966 LT	1,966 LT	1,921 LT	1,921 LT
3	Outfit	1,523	1,523	1,207	1,207
4	Machinery	782	782	782	782
5	TOTAL Light Ship Weight	4,271 LT	4,271 LT	3,910 LT	3,910 LT
6	Construction Cost				
7	Hull Structure	\$ 3,408,900	\$ 5,068,400	\$ 3,357,200	\$ 4,953,200
8	Outfit	6,293,500	6,293,500	4,987,700	4,987,700
9	Machinery	3,790,000	3,790,000	3,790,000	3,790,000
10	General	1,121,200	1,121,200	1,121,200	1,121,200
11	Subtotal	\$14,613,600	\$16,273,100	\$13,256,100	\$14,852,100
12	Profit (10%)	1,461,400	1,627,300	1,325,600	1,485,200
13	Tooling	612,600	612,600	612,600	612,600
14	TOTAL Construction Cost	\$16,687,600	\$18,513,000	\$15,194,300	\$16,949,900
15	Vessel Expense/Yr.				
16	Wages	\$ 979,900	\$ 979,900	\$ 979,900	\$ 979,900
17	Subsistence	40,500	40,500	40,500	40,500
18	Stores and Supplies	50,600	50,600	50,600	50,600
19	Fuel (including port fuel)	173,700	173,700	173,700	173,700
20	Maintenance and Repair	150,000	150,000	150,000	150,000
21	Insurance	301,800	325,600	282,500	305,200
22	TOTAL Vessel Expense	\$ 1,696,500	\$ 1,720,300	\$ 1,677,200	\$ 1,699,900
23	Owner's Expense/Yr.				
24	Cost of Capital Recovery	\$ 2,250,700	\$ 2,496,800	\$ 2,049,300	\$ 2,286,000
25	Overhead	50,000	50,000	50,000	50,000
26	Miscellaneous	20,000	20,000	20,000	20,000
27	TOTAL Owner's Expense	\$ 2,320,700	\$ 2,566,800	\$ 2,119,300	\$ 2,356,000
28	TOTAL AVERAGE Annual Cost = 22 + 27	\$ 4,017,200	\$ 4,287,100	\$ 3,796,500	\$ 4,055,900
29	Annual Cargo Carried (Long Tons)	155,500	155,500	158,600	158,600
30	Required Freight Rate = 28 ÷ 29	\$25.83/ton	\$27.57/ton	\$23.94/ton	\$25.57/ton
31	RFR Differential - Baseline GRP	- \$0.24	- \$0.26	- \$2.13	- \$2.26
32	RFR Differential - Baseline Steel	+ \$0.81	+ \$2.55	- \$1.08	+ \$0.55

TABLE 24 (Cont'd)

SUMMARY OF SENSITIVITY STUDIES C, D AND E

Line No.	Item	Study C Cost Criteria Main Structure		Study D Cost Criteria Tooling and Subsystems		Study E Combination	
		Low Cost	High Cost	Low Cost	High Cost	Low Cost	High Cost
1	Light Ship Weight						
2	Hull Structure	2,034 LT	2,034 LT	2,034 LT	2,034 LT	1,852 LT	1,852 LT
3	Outfit	1,523	1,523	1,523	1,523	1,207	1,207
4	Machinery	782	782	782	782	782	782
5	TOTAL Light Ship Weight	4,339 LT	4,339 LT	4,339 LT	4,339 LT	3,841 LT	3,841 LT
6	Construction Cost						
7	Hull Structure	\$ 2,982,100	\$ 4,304,500	\$ 3,496,300	\$ 5,171,200	\$ 2,673,800	\$ 3,885,000
8	Outfit	6,293,500	6,293,500	6,293,500	6,293,500	4,953,200	4,953,200
9	Machinery	3,790,000	3,790,000	3,540,000	3,540,000	3,540,000	3,540,000
10	General	1,121,200	1,121,200	1,121,200	1,121,200	1,121,200	1,121,200
11	Subtotal	\$14,186,800	\$15,509,200	\$14,451,000	\$16,125,900	\$12,288,200	\$13,499,400
12	Profit (10%)	1,418,700	1,550,900	1,445,100	1,612,600	1,228,800	1,349,900
13	Tooling	612,600	612,600	408,400	408,400	408,400	408,400
14	TOTAL Construction Cost	\$16,218,100	\$17,672,700	\$16,304,500	\$18,146,900	\$13,925,400	\$15,257,700
15	Vessel Expense/Yr.						
16	Wages	\$ 979,900	\$ 979,900	\$ 979,900	\$ 979,900	\$ 979,900	\$ 979,900
17	Subsistence	40,500	40,500	40,500	40,500	40,500	40,500
18	Stores and Supplies	50,600	50,600	50,600	50,600	50,600	50,600
19	Fuel (including port fuel)	173,700	173,700	173,700	173,700	173,700	173,700
20	Maintenance and Repair	150,000	150,000	150,000	150,000	150,000	150,000
21	Insurance	295,800	314,700	289,400	313,300	258,500	275,800
22	TOTAL Vessel Expense	\$ 1,690,500	\$ 1,709,400	\$ 1,684,100	\$ 1,708,000	\$ 1,553,200	\$ 1,670,500
23	Owner's Expense/Yr.						
24	Cost of Capital Recovery	\$ 2,187,300	\$ 2,383,500	\$ 2,199,000	\$ 2,447,500	\$ 1,878,100	\$ 2,057,800
25	Overhead	50,000	50,000	50,000	50,000	50,000	50,000
26	Miscellaneous	20,000	20,000	20,000	20,000	20,000	20,000
27	TOTAL Owner's Expense	\$ 2,257,300	\$ 2,453,500	\$ 2,269,000	\$ 2,517,500	\$ 1,948,100	\$ 2,127,800
28	TOTAL AVERAGE Annual Cost = 22 + 27	\$ 3,947,800	\$ 4,162,900	\$ 3,953,100	\$ 4,225,500	\$ 3,601,300	\$ 3,798,300
29	Annual Cargo Carried (Long Tons)	155,000	155,000	155,000	155,000	159,100	159,100
30	Required Freight Rate = 28 ÷ 29	\$25.47/ton	\$26.86/ton	\$25.50/ton	\$27.26/ton	\$22.64/ton	\$23.87/ton
31	RFR Differential - Baseline GRP	- \$0.60	- \$0.97	- \$0.57	- \$0.57	- \$3.43	- \$3.96
32	RFR Differential - Baseline Steel	+ \$0.45	+ \$1.84	+ \$0.48	+ \$2.24	- \$2.38	- \$1.15

TABLE 25

SUMMARY OF SENSITIVITY STUDY F - FIRE-RETARDANT RESINS

<u>Line No.</u>	<u>Item</u>	<u>Low Cost</u>	<u>High Cost</u>
1	Light Ship Weight		
2	Hull Structure	2134 L.T.	2134 L.T.
3	Outfit	1530	1530
4	Machinery	782	782
5	TOTAL Light Ship Weight	4445 L.T.	4445 L.T.
6	Construction Cost		
7	Hull Structure	\$ 3,891,800	\$ 5,651,400
8	Outfit	6,293,500	6,293,500
9	Machinery	3,790,000	3,790,000
10	General	1,121,200	1,121,200
11	Subtotal	\$15,096,500	\$16,856,100
12	Profit (10%)	1,509,700	1,685,600
13	Tooling	612,600	612,600
14	TOTAL Construction Cost	\$17,218,800	\$19,154,300
15	Vessel Expense/Yr.		
16	Wages	\$ 979,900	\$ 979,900
17	Subsistence	40,500	40,500
18	Stores and Supplies	50,600	50,600
19	Fuel (including port fuel)	173,000	173,000
20	Maintenance and Repair	150,000	150,000
21	Insurance	308,800	333,800
22	TOTAL Vessel Expense	\$ 1,702,800	\$ 1,727,800
23	Owner's Expense/Yr.		
24	Cost of Capital Recovery	\$ 2,322,300	\$ 2,583,300
25	Overhead	50,000	50,000
26	Miscellaneous	20,000	20,000
27	TOTAL Owner's Expense	\$ 2,392,300	\$ 2,653,300
28	TOTAL Average Annual Cost = (22) + (27)	\$ 4,095,100	\$ 4,381,100
29	Annual Cargo Carried (Long Tons)	154,100	154,100
30	Required Freight Rate = (28) ÷ (29)	\$26.57/ton	\$28.43/ton
31	RFR Differential - Baseline GRP	+ \$0.50	+ \$0.60
32	RFR Differential - Baseline Steel	+ \$1.55	+ \$3.41

TABLE 26

SUMMARY OF SENSITIVITY STUDY G - DEADWEIGHT UTILIZATION

<u>Line No.</u>	<u>Item</u>	<u>Low Cost</u>	<u>High Cost</u>
1	TOTAL Average Annual Cost - From Table 23	\$4,041,100	\$4,313,400
2	Annual Cargo Carried (Long Tons)	167,100	167,100
3	Required Freight Rate = (1) ÷ (2)	\$24.18/ton	\$25.81/ton
4	RFR Differential - Baseline GRP	- \$1.89	- \$2.02
5	RFR Differential - Baseline Steel	- \$0.84	+ \$0.79

VI. ALTERNATIVE TYPES OF LARGE GRP SHIPS

This phase of the study investigates the feasibility of using GRP for the construction of alternative types of large ships, including container-ships, bulk carriers and others. In general, these studies are primarily economic rather than technical, under the assumption that the technical considerations would be essentially identical to those for the cargo ship. However, where operational differences exist between these alternative ship types and a cargo ship which would have a bearing on technical feasibility, these factors are briefly discussed.

The studies of alternative GRP ship types are based upon the assumptions, criteria and procedures used for the GRP cargo ship studies except as noted. All studies are based upon a 5-ship procurement and a 20 year ship life. Hulls are fabricated with composite unidirectional/woven roving laminate, using average layup rates.

CONTAINER SHIP

Characteristics. The baseline steel container ship used for this study is derived from Reference (36), and has the principle characteristics shown in Table 27. The arrangements are shown in Figure 9. This particular design was chosen because it is representative of typical small medium speed container ships now being built, and because Reference (36) contains an economic model of the ship which facilitates this study.

TABLE 27

PRINCIPAL CHARACTERISTICS - STEEL CONTAINER SHIP

Length between perpendiculars	490 feet
Beam	76 feet
Draft (design)	28-1/2 feet
Draft (scantling)	30 feet
Depth	43-1/2 feet
Container capacity (24' x 8' x 8-1/2')	520 vans
Cargo oil capacity	3,188 tons
Deadweight	14,990 tons
Light ship	6,210 tons
Displacement	21,200 tons
Sea speed, knots	16-1/2 knots
Shaft horsepower (normal)	10,000 SHP

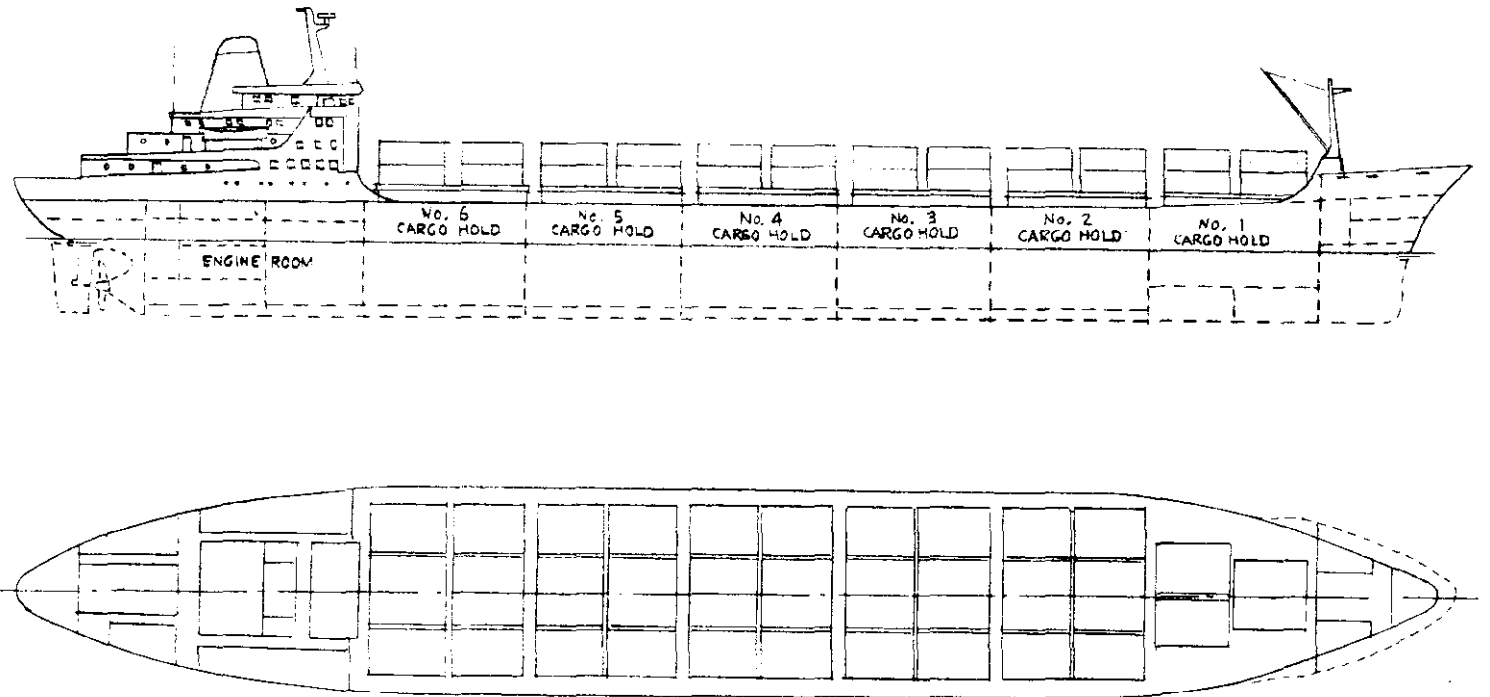

FIGURE 9

GENERAL ARRANGEMENT - CONTAINER SHIP

Weights. The light ship weight estimates for steel and GRP container ships are shown in Table 28, based upon the weight ratios derived from the cargo ship studies.

TABLE 28

LIGHT SHIP WEIGHT ESTIMATES
STEEL AND GRP CONTAINER SHIPS

<u>Item</u>	<u>Steel</u>			<u>GRP</u>		
	<u>L. Tons</u>	<u>VCG Above BL, Ft.</u>	<u>LCG from Midships, Ft.</u>	<u>Weight L. Tons</u>	<u>VCG Above BL, Ft.</u>	<u>LCG from Midships, Ft.</u>
Structure	4383	27.84	9.8 A	2630	27.28	9.4 A
Outfit	1120	40.89	29.4 A	1064	42.12	28.5 A
Machinery	<u>707</u>	<u>24.80</u>	<u>174.6 A</u>	<u>707</u>	<u>24.80</u>	<u>174.6 A</u>
Light Ship	6210	29.85	32.1 A	4401	30.47	40.6 A

The reductions on hull structure and light ship weight for the GRP container ship are 40 and 28 per cent respectively.

Construction Costs. The estimated cost for each of 5 identical steel and GRP container ships at 1970 price levels is shown in Table 29.

TABLE 29

CONSTRUCTION COST - STEEL AND GRP CONTAINER SHIPS

<u>Item</u>		<u>Steel</u>	<u>GRP</u>
Structure,	\$	2,060,000	3,440,000
Outfit,	\$	4,170,000	5,025,000
Machinery,	\$	2,542,000	3,290,000
General Cost,	\$	1,100,000	1,420,000
Tooling	\$	-	540,000
Profit	\$	<u>988,000</u>	<u>1,373,000</u>
Total Cost	\$	10,860,000	15,088,000

The GRP container ship is about 41 per cent more expensive than the equivalent steel ship, whereas the corresponding increase for the GRP cargo ship is only 28 per cent. This reflects the proportionally higher cost of the hull structure of a container ship not fitted with deck cranes.

Life Cycle Costs. The average annual cost and RFR for the proposed GRP container ship are compared to those of the equivalent steel ship in Table 30. The life cycle operational profile is based upon the data in Reference (36), which assumes a 2,200 nautical mile steaming distance, 22 round trips per year, carrying cargo oil and 520 containers. For the steel ship, the average weight per container is assumed to be 13 tons. For the GRP container ship, the increase in deadweight was derived similarly to the GRP cargo ship, by assuming that one-half of the additional "effective" available deadweight (0.7 times the total additional deadweight) would be utilized.

For the specific case investigated (5-ship procurement, 20 year life) Table 30 indicates that the RFR of the GRP containership is \$1.00 higher than that of the steel ship. The corresponding increase for GRP and steel general cargo ships is \$2.45. Therefore it can be concluded that a GRP container ship represents a better economic investment than the GRP general cargo ship evaluated previously, but that a steel ship would still be a better investment.

Technical Considerations. The principle area in which the technical feasibility of a GRP container ship and general cargo ship differ is hull torsional stiffness. The all-hatch concept used in the design of container ships has led to concern for the torsional strength and stiffness of steel hulls, resulting in the use of deep transverse and longitudinal box girders in the upper portion of the hull, outboard of and between the hatches. The torsional characteristics of a GRP container ship appear to present a serious technical problem requiring thorough investigation.

Other technical considerations include proper distribution of container corner post loads, particularly at the tank top; maintaining alignment of container guide cells; support of crane rails (if required); provision of adequate deck area for longitudinal strength, with special consideration of very thick laminates.

TABLE 30
SUMMARY OF LIFE CYCLE COSTS
FOR STEEL AND GRP CONTAINER SHIP

<u>Line No.</u>		<u>Steel</u>	<u>GRP</u>
1	Vessel Expense/Yr.		
2	Wages	\$1,088,800	\$1,088,800
3	Subsistence	45,000	45,000
4	Stores and Supplies	56,200	56,200
5	Fuel (including Port Fuel)	306,400	275,800
6	Maintenance and Repair	100,000	100,000
7	Insurance	200,600	284,900
8	TOTAL Vessel Expense	\$1,797,000	\$1,850,700
9	Owner's Expense/Yr.		
10	Cost of Capital Recovery	\$1,464,700	\$2,055,100
11	Overhead	50,000	50,000
12	Miscellaneous	20,000	20,000
13	Salvage	-2,700	-
14	TOTAL Owner's Expense	\$1,532,000	\$2,125,100
15	TOTAL Average Annual Cost = 8 + 14	\$3,329,000	\$3,975,800
16	Annual Cargo Carried (Long Tons)	355,700	383,600
17	Required Freight Rate (RFR) = 15 ÷ 16	\$9.36/ton	\$10.36/ton

BULK CARRIER

Characteristics. This study is based upon a similar investigation of equivalent aluminum and steel bulk carriers in Reference (25). The bulk carrier being considered is the MV CHALLENGER, with the characteristics shown in Table 31.

TABLE 31

PRINCIPAL CHARACTERISTICS - BULK CARRIER MV CHALLENGER

Length Over-all	632'-10"
Length Between Perpendiculars	590'-6-1/2"
Beam	88'-7"
Depth	52'-2"
Draft	35'-9"
Deadweight	36,858 LT max.
Light Ship	7,892 LT
Displacement	44,750 LT max.
Shaft Horsepower	9,600 max. (Diesel)
Design Speed	14.8 knots

Figure 10, derived from Reference (25), shows the arrangements of the steel vessel.

Weights. Table 32 summarizes the light ship weight estimates including margins for the steel, aluminum and GRP. Weight ratios with steel are indicated in parenthesis. The weights for steel and aluminum ships are from Reference (25), while the GRP ship weights are proportioned from the container ship weights in Table 28.

TABLE 32

LIGHT SHIP WEIGHT ESTIMATES
STEEL, ALUMINUM AND GRP BULK CARRIERS

<u>Item</u>	<u>Steel</u>	<u>Aluminum</u>	<u>GRP</u>
Structure, L. Tons	5920	3375 (.57)	3550 (.60)
Outfit, L. Tons	1190	1027 (.86)	1027 (.86)
Machinery, L. Tons	<u>752</u>	<u>720 (.96)</u>	<u>720 (.96)</u>
Light Ship, L. Tons	7892	5220 (.66)	5297 (.67)

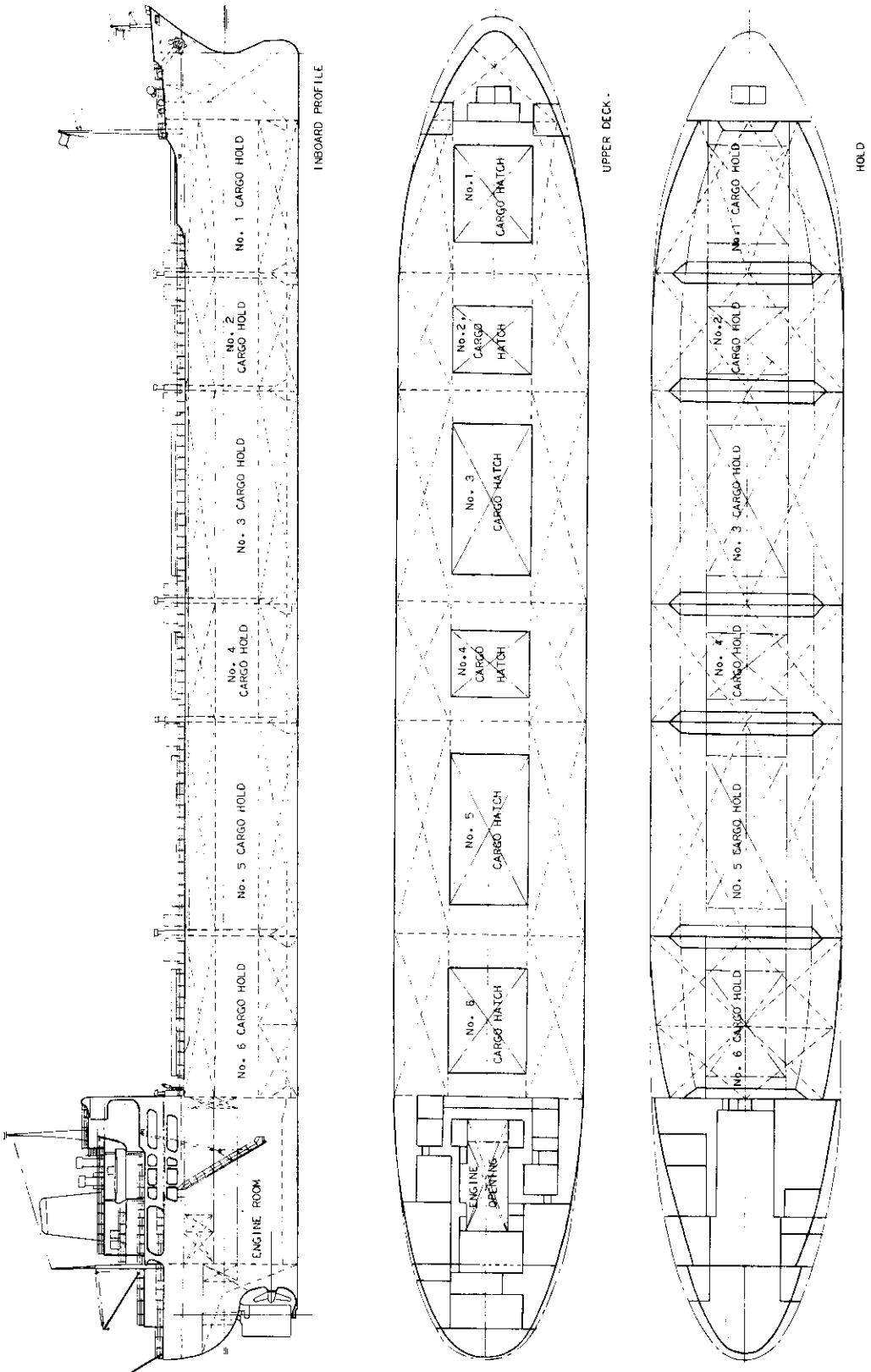

FIGURE 10
GENERAL ARRANGEMENT - BULK CARRIER MV CHALLENGER

This table indicates that the GRP bulk carrier will be slightly heavier than an aluminum ship of similar size, and will thus have a slightly lower increase in cargo deadweight relative to the steel ship.

Construction Cost. The estimated cost for each of 5 identical steel, aluminum and GRP bulk carriers at 1970 price levels is shown in Table 33. Aluminum and steel costs are based upon data in Reference (25). GRP structure costs are based upon the cost per pound obtained from the study of the GRP cargo ship, while machinery and outfit costs are assumed to be identical to the aluminum ship.

TABLE 33

CONSTRUCTION COST - STEEL, ALUMINUM AND GRP BULK CARRIERS

<u>Item</u>		<u>Steel</u>	<u>Aluminum</u>	<u>GRP</u>
Structure,	\$	3,377,000	6,175,000	6,854,000
Outfit,	\$	4,049,000	4,203,000	4,203,000
Machinery,	\$	2,192,000	2,349,000	2,349,000
General Cost,	\$	1,216,000	1,597,000	1,597,000
Tooling,	\$	-	-	974,000
Profit,	\$	<u>1,085,000</u>	<u>1,432,000</u>	<u>1,598,000</u>
Total Cost	\$	11,919,000	15,756,000	17,575,000

The GRP bulk carrier is approximately 46 per cent more expensive than the steel ship, versus 28 per cent for the cargo ship. This reflects the proportionally higher cost of the hull structure of a bulk carrier.

Cost Analysis. Reference (25) indicates that an aluminum bulk carrier will have a higher Required Freight Rate than the equivalent steel bulk carrier, regardless of voyage length, vessel life or level of procurement. Since the GRP bulk carrier weighs more and costs more than the aluminum ship, and has less scrap value, it can be concluded that the GRP bulk carrier will be even less attractive economically than an aluminum one.

Technical Considerations. The only area in which the technical feasibility of a GRP bulk carrier would require further study than for a GRP cargo ship would be in the area of impact and abrasion protection in the cargo hold. It is likely that a layer of steel or other impact and abrasion resistant material would be required to protect the GRP tank top and lower bulkheads from damage by grab buckets and bulldozers used in cargo discharge.

OTHER TYPES OF GRP VESSELS

The foregoing studies strongly indicate that, within the present state-of-the-art, GRP is both technically and economically undesirable compared to conventional steel construction for large cargo ships, container ships

and bulk carriers. It appears logical to extend this conclusion to other types of large vessels as well, including tankers, oil-bulk-ore (OBO) vessels, LASH ships, and others.

In contrast to the above, it is generally recognized that GRP is economically competitive with steel on a life cycle basis in smaller craft, such as fishing vessels, due to proportionally greater weight savings and maintenance cost savings. Therefore it would appear that GRP might be competitive with steel for small coastwise tankers and freights in the 150 to 250 foot range. Smaller GRP vessels of this type also represent a substantially smaller technical and economic risk, and should be evaluated in further detail.

The use of GRP for the structure of tankers intended to carry flammable or combustible liquids is presently unacceptable since the U.S. Coast Guard requires that such vessels be of steel construction. Thus the use of GRP for such tankers would require a relaxation of this requirement, necessitating an extensive evaluation of the risk involved and alternate methods of satisfying the intent of the Coast Guard requirements.

VII. INVESTIGATION OF LARGE GRP STRUCTURAL COMPONENTS

This phase of the study presents technical and economic evaluations of using GRP in lieu of steel for a selected number of large structural components on a cargo ship.

APPROACH

This investigation is based on the assumption that the components to be considered should be discrete, well definable structural elements, such as a deckhouse, section of deck or platform, a bulkhead, hatch cover or other similar items. Use of GRP for portions of other major steel components, such as a section of the hull girder amidships has not been given detailed consideration for the following reasons:

- o Use of GRP for such portions would introduce a major discontinuity in the over-all structural arrangement of the component, and would introduce severe problems in transferring hull loads around or through the GRP portion. This discontinuity could seriously degrade the over-all strength and stiffness of the hull.
- o The attachment of the GRP portion to the steel would be difficult and expensive.
- o Substitution of GRP for steel in this manner would not result in sufficient weight and maintenance saving to justify the higher first cost. This is particularly true if the steel hull girder must be reinforced significantly in way of the discontinuity introduced by GRP.

Prior to undertaking this study, the detail hull weight estimate of the SS JAMES LYKES was reviewed, with each item evaluated for the following criteria:

- o Would the use of GRP in lieu of steel reduce weight significantly?
- o Would the use of GRP improve stability?
- o Is the item particularly susceptible to corrosion and, therefore, a high-maintenance item?
- o Is a smooth, easily-cleaned or maintained surface desirable?
- o Is the part subjected to a severe impact or abrasion environment?
- o Is deflection or vibration critical?
- o Is it a complex shape, where the easy moldability of GRP could be an advantage?
- o Would it be difficult to attach the GRP item to the steel hull?
- o What are potential construction cost differences?

- o What quantities are involved?

The following potential components were selected on the basis of the above evaluations:

- o Deckhouse
- o Hatch covers
- o King posts
- o Edible oil tank boundaries
- o Bulwarks
- o Decks which are not part of the hull girder
- o Bulkheads - structural
- o Bulkheads - non-structural
- o Immersed portion of bow and stern
- o LASH barges

The deckhouses, hatch covers and king posts were studied in some detail, and the conclusions derived from these studies are extended to the other items, which are discussed briefly.

The design approach adopted for these studies involved the following basic steps:

- o Establish design criteria
- o Design GRP component equivalent in strength to the steel component
- o Compare weights
- o Compare construction costs
- o Evaluate life cycle economics

Figure 11 provides guidance relative to the maximum acceptable increase in acquisition cost of GRP components over that of the equivalent steel component as a function of weight savings. This Figure is based upon data in Appendix A, and assumes equivalence of Required Freight Rates for the all-steel ship and the ship with GRP components. This Figure indicates that the allowable cost premium increases rapidly as the weight savings increases, and that the premium can be greater for more expensive steel components. It is noted that these values are slightly conservative in that the possible reduced maintenance costs of GRP are not included. However, they assume that the weight savings can be converted to additional revenue at least 70 per cent of the time.

DECKHOUSE

As noted previously, present U.S. Coast Guard rules would prohibit the use of GRP for the structure of a merchant ship deckhouse, making this study academic at this time. However, it is of interest to determine if the use of

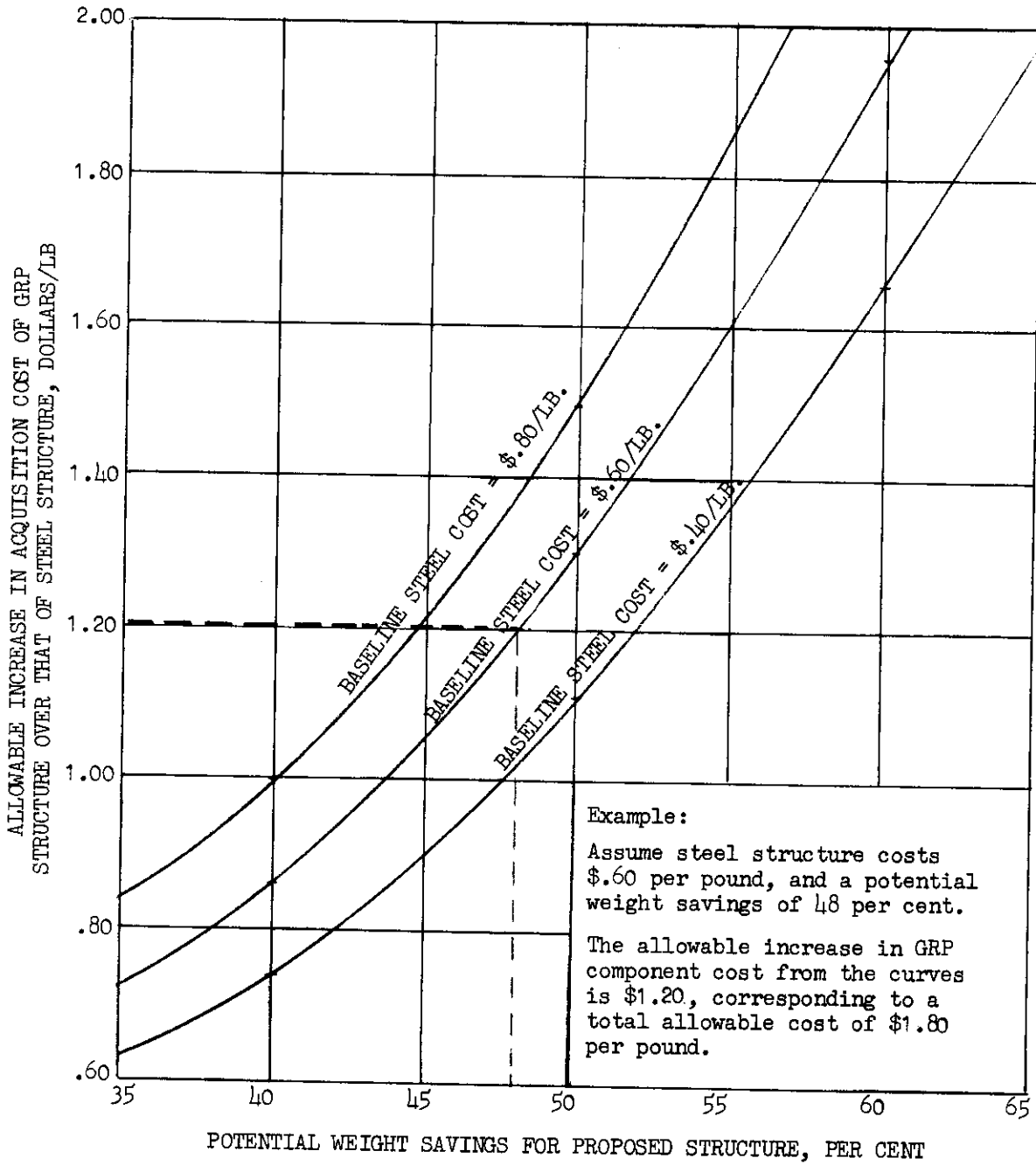

FIGURE 11

ALLOWABLE INCREASE IN ACQUISITION COST OF GRP COMPONENTS

GRP in conjunction with a system of insulation and protective sheathing has any potential economic merit. If this is the case, further consideration of such a proposal is warranted.

This investigation considers the forward subassembly of the deckhouse of the JAMES LYKES located between No. 3 and 4 Holds above the Upper Deck.

Sandwich construction was selected for the GRP deckhouse since it satisfies strength, stiffness and insulation requirements. The core consists of closely-spaced GRP shear webs separating the faces with the intervening voids filled with polyurethane foam of 2 pounds per cubic foot density. This was necessary because of the excessive core thickness required to satisfy shear strength if structural grade foam had been used as the core material. Use of fire-retardant resins was assumed throughout.

Criteria - House Front, Sides and End. The GRP deckhouse sandwich panels are designed by converting the steel scantlings using Equation (4) in Section III, except that a correction factor of 1.5 is used versus 1.6. This is possible because the lower strength of GRP in the wet condition is not critical for a deckhouse. The sandwich panels are assumed to be simply supported on all edges, subjected to a uniform load over their surface. A deflection limit of $L/100$ is imposed.

Criteria - Deckhouse Decks. The decks of the GRP superstructure are designed for the same criteria as the front, sides and end except for a deflection limitation of $L/200$ under a uniform load of 100 PSF.

Summary of Scantlings. Table 34 summarizes the scantlings of the steel and GRP deckhouses, where consideration is given to both an all-woven roving and a composite woven roving-unidirectional laminate.

Weights. Table 35 summarizes the weight of structure and thermal insulation for the primary steel and GRP deckhouse elements. Fire insulation and joiner work are not included, but will be discussed later. This Table indicates that the potential weight savings afforded by GRP are quite appreciable, and reflect the weight and cost required for the corrosion allowances required for relatively thin steel plates.

Construction Costs. The cost of constructing and insulating the GRP and steel deckhouses is shown in Table 36, based upon a 5-ship procurement and the criteria of Section V.

GRP labor costs are based upon a layup rate of 15 pounds per manhour and a labor rate of \$3.00 per hour. Tooling and engineering are assumed to add 20 per cent to the production cost. The labor cost is based upon present hand layup productivity and could be reduced by automation and modularization if enough identical units are to be produced.

Cost Evaluation. Table 36 indicates that the construction cost of a GRP deckhouse is slightly lower than an equivalent insulated steel deckhouse, primarily due to the high cost of insulating the steel. Figure 11 indicates that the cost per pound of the GRP deckhouse could be about \$1.00 per pound higher than that of the steel house, or about \$1.67.

TABLE 34

SCANTLINGS - GRP AND STEEL DECKHOUSES

<u>Item</u>	<u>Steel</u>	<u>Scantlings</u>	
		<u>Woven Roving</u>	<u>Composite</u>
(1) House Front and Side - Upper Deck to Navigating Bridge Deck	12.75# Plating 6x12.3# L at 30"	4" core 3/8" skins 3/16" shear webs at 6"	4" core 3/16" skins 3/16" shear webs at 6"
(2) After House End - Upper Deck to Forward House Top	10.2# Plating 3-1/2x2-1/2x4.9# L at 30"	3" core 3/16" skins 3/16" shear webs at 18"	2" core 3/16" skins 3/16" shear webs at 12"
(3) Cabin Deck	10.2# Plating 5x3x6.6# L Inbd. 8x17.2# L Outbd. at 30"	3" core 1/4" skins 1/4" shear webs at 12"	2" core 3/16" skins 1/4" shear webs at 9"
(4) Navigating Bridge Deck	10.2# Plating Inbd. 11.48# Plating Outbd. 5x3x6.6# L Inbd. 8x17.2# L Outbd. at 30"	2.5" core 3/16" skins 3/16" shear webs at 12"	2" core 3/16" skins 3/16" shear webs at 9"
(5) Forward House Top	10.2# Plating 5x3x6.6# L at 30"	2" core 3/16" skins 3/16" shear webs at 18"	1.5" core 3/16" skins 3/16" shear webs at 15"

TABLE 35

WEIGHT COMPARISON - GRP AND STEEL DECKHOUSES

Item	Area (Both Sides) (Ft ²)	GRP Weight ^(a) lbs		Equivalent Steel Weight, Lbs		
		WR	Composite	Structure	Insulation	Total
(1) House Front and Side - Upper Deck to Navigating Bridge Deck	1618	16827	11035	25220	1232	26432
(2) After House End - Upper Deck to Forward House Top	1384	7612	7598	17394	1187	18581
(3) Cabin Deck	1870	13221	10771	27412	132	27544
(4) Navigating Bridge Deck	1550	8510	8696	25324	515	25839
(5) Forward House Top	1215.6	6345	6431	15060	835	15895
Total		52515	44531			114291
Wt GRP/Wt Steel		.46	.39			

(a) Includes weight of core material

TABLE 36

CONSTRUCTION COST COMPARISON - GRP AND STEEL DECKHOUSES

Item	Steel	GRP	
		Woven Roving	Composite
Structure:			
Material	-	37,600	33,100
Labor	-	14,400	12,200
Overhead (150%)	-	21,600	18,300
Facility Amort. (15%)	-	11,000	9,500
Tooling (5 Ships)	-	16,000	16,000
Profit (10%)	-	<u>7,400</u>	<u>6,400</u>
Total	\$ 74,600	106,000	95,500
Insulation Total	\$ <u>38,300</u>	-	-
Total Cost	\$ 112,900	106,000	95,500
Cost Per Pound	\$ 0.67	1.47	1.56

As noted previously, this cost study does not reflect the cost of additional fire protection deck covering and insulation. Based upon data in Reference (25), the weight and cost of this added protection would be about 15,000 pounds and \$30,000 respectively. This would result in the cost of the protected GRP house being about \$25,000 higher than the steel house and the weight savings reduced to between 40 and 50 per cent. However, the concept is still economically feasible.

Based upon the above analysis, a GRP deckhouse is a potentially attractive candidate for incorporation on a steel ship contingent upon U.S. Coast Guard acceptance of properly protected GRP as a deckhouse structural material in living and working areas. A composite laminate would be preferable to a woven roving laminate on the basis of weight and cost.

CARGO KING POST

This investigation considers a typical 10 ton cargo king post supported rigidly at the Main and Upper Tween Decks and partially by the winch platform house. A unidirectional/woven roving composite laminate is assumed, with the unidirectional material parallel to the long axis of the king post. A woven roving laminate is not considered due to inadequate cost-stiffness relationships compared to the composite laminate. The king post is of constant circular cross section between its base and the winch platform, and tapers slightly to 75 per cent of its maximum diameter at the upper tip. General purpose resin is used in lieu of fire-retardant resin since these king posts are located in an area where the possibility of a fire starting is remote.

Criteria. The GRP king post is designed for a safety factor 1.5 times the ABS required factor of 5 on the ultimate strength of the material. This increase in the safety factor is less than that shown in Section III for the reasons noted previously in the discussion of the deckhouse. A minimum safety factor of 2.0 on the local or over-all buckling strength is used. No deflection limitation is imposed, though consideration must be given to the increase in secondary moment due to greater eccentricity of axial loads from the topping lift.

The loading diagram for the GRP king post is assumed to be identical to that of the steel king post.

Summary of Scantlings. Table 37 summarizes the scantlings of the GRP and steel king posts. The GRP king post is circular, of varying diameter while the steel king post is a 36 inch by 24-1/2 inch rectangle with 6 inch corner radii. The steel king post is HTS.

The unstayed deflection at the top of the GRP king post for the most critical loading condition is about 17 inches. The corresponding unstayed deflection of a steel king post for similar bending moments would be approximately 11 inches and 5 inches in the transverse and longitudinal direction respectively.

TABLE 37

SCANTLINGS - GRP AND STEEL KING POSTS

<u>Location</u>	<u>Scantlings</u>	
	<u>GRP</u>	<u>Steel</u>
Upper End	36" OD x 1-1/2" thick	20.4 lb. plate
Boom Heel	44" OD x 1-1/2" thick	33.15 lb. plate (a)
Winch Platform	48" OD x 1-1/2" thick	33.15 lb. plate (a)
Main Deck	48" OD x 1-1/2" thick	33.15 lb. plate (a)
Bottom	48" OD x 1-1/2" thick	20.4 lb. plate (a)

(a) 11" x 5/8" doubler on fore and aft face.

Weights. The steel and GRP king posts weigh approximately 18,500 pounds and 10,150 pounds respectively, exclusive of ladders, fittings, etc. This represents a weight ratio of 0.55. For the entire ship, the corresponding total amounts would be 139 tons and 89 tons respectively; a 50 ton savings for the GRP.

Construction Costs. The estimated costs to fabricate the steel and GRP king posts are \$15,600 and \$15,500 respectively, including tooling. These costs are based upon unit costs of \$0.83 and \$1.50 per pound for steel and GRP respectively. It can be assumed that the total GRP king post cost, including fittings and installation, will be perhaps 25 per cent higher than that of a steel king post, due primarily to attachment problems. Within the accuracy of this study, however, it is reasonable to assume that the GRP king posts represent an attractive economic prospect, since the allowable increase in unit cost from Figure 11 is about \$1.10 per pound, corresponding to a GRP price of \$1.93 per pound. It would not appear difficult to keep below this upper limit for large-scale production of GRP king posts.

HATCH COVERS

This investigation considers a number of typical hydraulically actuated watertight and nontight hatch cover panels similar in geometry and operation to those installed on the SS JAMES LYKES. The typical cover sections are 25 feet 9 inches wide, varying from 4-1/2 to 9-1/2 feet in length to suit the size of the hatch opening, and with a structural depth of about 14 inches. The steel covers have longitudinal secondary framing attaching to either two or three deep transverse girders as shown in Figure 12.

The equivalent GRP hatch cover is of sandwich construction, with a uni-directional/woven roving composite laminate, to provide maximum stiffness for minimum weight. The depth of the cover panel was kept similar to that of the steel cover to provide equivalent loss of cubic in the closed position, and similar over-all stacking dimensions in the open position. They are fabricated with fire-retardant resins.

The GRP covers incorporate shear webs rather than relying on the strength of the core material, similar to the deckhouse panels. A typical GRP hatch cover panel is shown in Figure 12 for comparison to the steel cover scantlings.

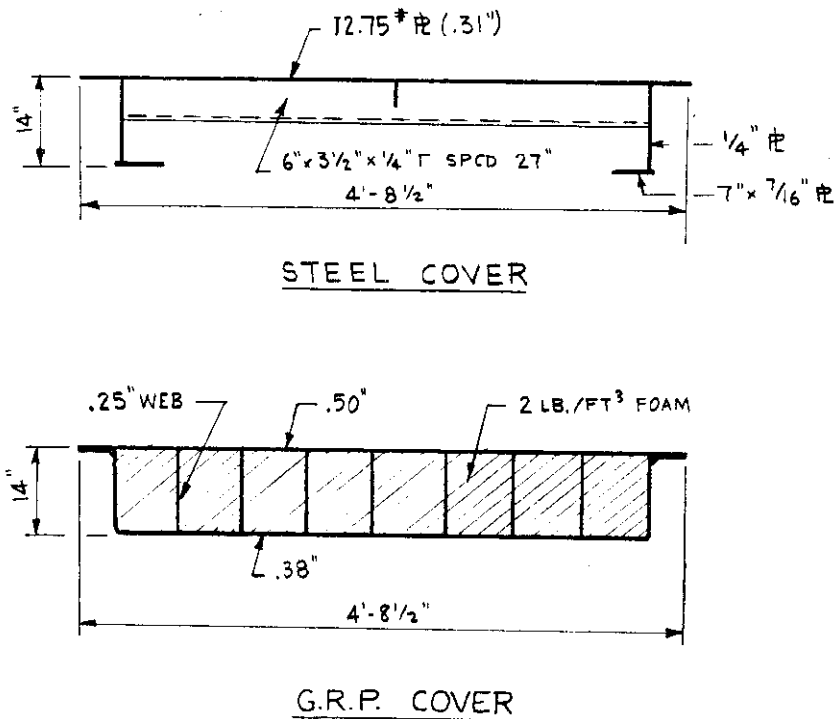

FIGURE 12

CROSS SECTION THROUGH TYPICAL STEEL
AND GRP HATCH COVERS

Criteria. The steel hatch covers are designed to suit current ABS criteria which require a safety factor of 4.25 on the ultimate strength of the material and a maximum deflection of 0.0028 times the span ($L/360$) for the following live loads:

- Weather deck hatch covers forward: 358 PSF
 - Weather deck hatch covers aft: 266 PSF
 - Tween deck hatch covers: $44.8H$ PSF
- where H is the height of cargo stowed in feet.

The GRP covers are designed for similar loads, though the safety factor on the ultimate strength is increased by a factor of 1.50, similar to the deckhouse and king posts. The deflection of the GRP panels is specified as

being a maximum of three times that of the permissible deflection of the steel covers, or about $L/120$. This is consistent with the deflection limitations proposed for deck panels under maximum design load, and requires similar consideration in stowing cargo to prevent its damage as the covers deflect downward. For hydraulically actuated hinged GRP covers such as those under consideration, deflections in excess of the steel covers may lead to excessive limberness, causing problems in opening and closing the covers and maintaining tightness. It should be noted that the deadload deflection of a GRP cover would only be 50 per cent greater than a steel cover due to reduction in weight. However, the large deflection under load will require the development of a suitable watertight gasketing system, or else the use of GRP covers will have to be limited to tween decks where tightness is not required.

Scantlings. Figure 12 shows the scantlings of comparable steel and GRP covers designed for the above criteria. The steel cover is strength critical while the GRP cover is deflection critical, even with the relaxation in requirements.

Weights. The average weights per square foot of the steel and GRP hatch covers shown in Figure 12 are 26 and 13 pounds respectively, representing a 50 per cent structural weight savings. For the entire ship, the weight of hatch covers would be reduced from 185 to about 105 tons; a savings of 80 tons for the GRP covers. This is equivalent to a weight reduction of about 40 per cent for the entire group, reflecting the unchanging weight of hinges, hydraulic components, seals, etc.

Costs. The estimated cost per pound to fabricate the basic structure of the steel and GRP hatch covers is \$0.75 and \$1.60 per pound respectively. These costs reflect the relatively high dimensional and quality control required for covers of this type, as well as the extensive tooling required for the large number of cover section sizes in a shipset. The steel hatch cover cost is similar to that for the structural steel of the deckhouse, while the GRP unit cost is based upon a manpower utilization rate of 15 pounds per hour. This high productivity appears achievable for the production of a very large number of identical cover units, and also leads to rapid amortization of the tooling cost. Other assumptions relative to GRP costs are identical to those for the deckhouse.

The over-all cost of the basic structure for the steel and GRP covers would be about \$270,000 and \$290,000 respectively, including tooling, a \$20,000 cost differential. The total differential of the installed covers would probably be considerably higher than this, due to greater difficulty attaching steel hinges, hydraulic components, dogs, etc. to the GRP covers, and possible problems introduced by the greater cover deflection. These will be offset somewhat by the possible reduction in the hydraulic cover opening system afforded by the lower cover weight.

Cost Evaluation. For the basic structure of the steel and GRP covers, the weight savings is 50 per cent, with a corresponding cost penalty of \$0.60 per pound. Figure 11 indicates that the cost penalty of a 50 per cent weight savings cannot exceed \$1.20 per pound, corresponding to a maximum price of \$2.80 per pound. This is within the state-of-the-art capabilities of the GRP industry. Thus, GRP hatch covers are a potentially attractive economic investment, if the weight savings can be converted to additional revenue.

OTHER COMPONENTS

The following additional components are considered possible candidates for the use of GRP in lieu of steel.

Edible Oil Tank Boundaries. Deep tanks are often provided aft, adjacent to the shaft alley, for the stowage of edible cargo oils. Cleanliness considerations usually dictate the use of cofferdam construction to provide smooth, easily maintained surfaces within the tanks. Stainless steel is specified for the inner tank surfaces where extreme cleanliness is required.

A molded GRP inner tank liner would appear to be economically feasible in this case. In addition to being light (about 50 to 60 per cent of the weight of equivalent steel liners) and economically competitive, it would be easily maintained and would not contaminate the cargo.

The attachment of this liner to the steel structure represents a potential problem, since it is desirable to avoid through-bolting which might eventually lead to leakage. A possible solution would be to bond GRP angles to the outer tank surface which overlap onto the supporting steel, and mechanically fasten the overlap to the steel after cure. As an alternative, the GRP liner could essentially "float" on the steel structure with no physical attachment, since all pressure loads would tend to push the GRP against the steel except in the case of flooding from outside the tank. In this case the faying surface between the GRP liner and the steel hull structure should be filled with a resilient resin putty to insure uniform bearing.

An acceptable and possible preferable alternative to the separately molded GRP liner would be to spray the inner mild steel surfaces with a flake-glass coating.

The use of GRP for this application would again be contingent upon U.S. Coast Guard approval.

Bulwarks. Protective bulwarks on the weather deck could be of GRP construction, with the bulwark brackets mechanically fastened to steel clips welded to the deck. GRP bulwarks would be approximately one-half as heavy as steel bulwarks, thereby saving about 15 tons, which would also improve stability. They would not be subjected to the corrosion and rusting associated with steel bulwarks.

GRP bulwarks present several problems, however. They would be less resistant to the type of impact and abrasion damage to which bulwarks are subjected, and would not be as good a foundation for the usual assortment of miscellaneous clips, cleats, pads, etc. as a steel bulwark.

Local Decks and Platforms. Decks and platforms which are not a part of the hull girder could be of GRP construction. These decks would consist of GRP sandwich panels supported by steel side shell stringers, girders and stanchions. The principle advantages of GRP in this application would be reduced weight and maintenance, though the deck surfaces might require protection from abrasion and impact.

Structural Bulkheads. The consideration applicable to decks, discussed previously, would apply to the structural bulkheads. Since the total weight

of structural bulkheads on the SS JAMES LYKES is about 320 tons, the potential weight savings is attractive. However, the substitution of GRP for steel in main transverse bulkheads could seriously affect the transverse strength and stiffness of the hull girder, particularly in racking. This would probably necessitate the installation of a steel trusswork in the plane of the bulkhead, to provide the required strength. This would decrease the weight savings and might increase the total thickness of the bulkhead, thereby reducing available cubic. Thus the economics of such a proposal are doubtful. In addition, GRP bulkheads bounding machinery spaces are presently unacceptable to the U.S. Coast Guard.

Non-Structural Bulkheads. The use of fire-retardant GRP panels for non-structural bulkheads appears to offer both a weight and life cycle cost savings, the latter due primarily to reduced maintenance. The major drawback to such a proposal is the potential fire problem, since such bulkheads would find wide use in living and working areas, where structural fire protection requirements apply. In most cases, such bulkheads would be of U.S. Coast Guard Class "B" or "C" construction, requiring that they be incombustible and for Class "B", capable of preventing the passage of smoke or flame for one-half hour. The incombustibility and integrity of proposed GRP panels would have to be clearly demonstrated by fire tests, and the question of toxicity would have to be resolved. These factors make the feasibility of this particular application questionable.

Immersed Portion of Bow. The immersed bow of a cargo ship or other relatively high speed vessel is both difficult and expensive to fabricate in steel, particularly if a bulbous bow is fitted. This difficulty arises from the relatively complex shape of the hull, requiring furnaced plates in most areas, as well as extensive bending of framing members. The design requirements for this structure are severe, including consideration of slamming loads on the flat of bottom, large hydrostatic heads, and cavitation erosion.

The use of a GRP module in this area would appear to offer several advantages over steel:

- o Lower relative cost for fabrication, due to the high cost of fabricating steel plates and shapes.
- o Lower weight for equivalent strength in satisfying life cycle slamming requirements without plastic deformation.
- o Elimination of erosion at the stern and near the waterline from cavitation and bow wave bubble sweepdown.
- o Greater resistance to inelastic deformation.
- o Less resistance due to smoother hull surface.
- o A frangible bow structure, which would collapse and absorb energy upon impact thus reducing the extent of damage in a collision.

The primary disadvantage would be the difficulty of mechanically attaching the GRP module to the steel hull structure.

For a typical 500 foot cargo vessel, with 29-1/2 inch frame spacing, the steel plate thickness required by American Bureau of Shipping for the bottom forward and immersed bow are 0.79 inches and 0.58 inches respectively. The

corresponding thicknesses of a unidirectional/woven roving GRP shell would be 1.05 inches and 0.77 inches respectively, weighing about 40 per cent as much as the equivalent steel plating. The weight savings of internal GRP structure (floors, frames, etc.) would probably be less, due to the added weight caused by bonding angles and local buckling considerations. However, it can be assumed that a GRP bow module will weigh about 50 per cent of the equivalent steel structure. The total weight savings could amount to as much as a hundred tons, depending upon the extent to which the GRP is used.

As an alternative to single skin with transverse floors on 30 inch centers, a sandwich panel with a 4 inch thick core and skin thicknesses of 0.6 inches on the bottom and 0.4 inches on the side supported on 7-1/2 foot centers would be acceptable, both for stress and deflection. This concept appears preferable, since less internal framing would be required and the larger panels would dampen impact loads to a greater extent than single skin. Figure 13 shows a concept where the GRP structure has been carried up to just above the waterline. The entire bow could be made of GRP, but the economic advantages of using GRP above the boottop area appear less due to lower corrosion rate, protection required for the anchor and difficulty of installing mooring gear. The shell panel would utilize longitudinally-oriented GRP shear webs for the reasons noted in the discussion of the deckhouse. The shell sandwich would be supported by corrugated GRP transverse floors of sufficient depth and thickness to avoid buckling failure, attached at the top to the steel deck. The extreme forward portion would be filled with high density foam both to support the shell panel and to act as a barrier to prevent flooding in the event of a minor collision. The inner skin of the shell would form a molded-in center keel.

The estimated cost for steel and GRP structure in the bow area is \$0.75 and \$2.00 per pound respectively, installed. Since the GRP structure will only weigh about 50 per cent of the steel structure weight, it appears that the GRP bow structure would be nearly competitive on a first-cost basis, and would definitely be competitive on a life cycle cost basis. Therefore, this concept appears both feasible and desirable if the GRP bow modules can be procured in sufficient quantity.

Immersed Portion of Stern. A GRP module similar to the bow module just discussed could be considered for the stern, since most of the plates on a steel stern assembly must be furnaceed. However, the difficulties foreseen in maintaining attachment and structural integrity on the GRP module appear prohibitive, because of the high propeller-induced loads and vibratory forces, as well as those from the rudder.

LASH Barges. The concept of a GRP LASH (Lighter Aboard Ship) Barge is not being considered in detail in this study, since it is not truly a structural component of a cargo ship. However, it would be an integral part of a LASH cargo ship operation, and is certainly worthy of mention as a potential candidate for GRP construction.

At the time of this study, a prototype GRP LASH barge is undergoing final testing and evaluation. The initial testing of this barge was successfully completed in mid-1971. Thus there appears to be no question as to the technical feasibility of such a barge.

Although the GRP barge is expected to sell for about 20 to 30 per cent more than an equivalent double-walled steel barge, this is expected to be

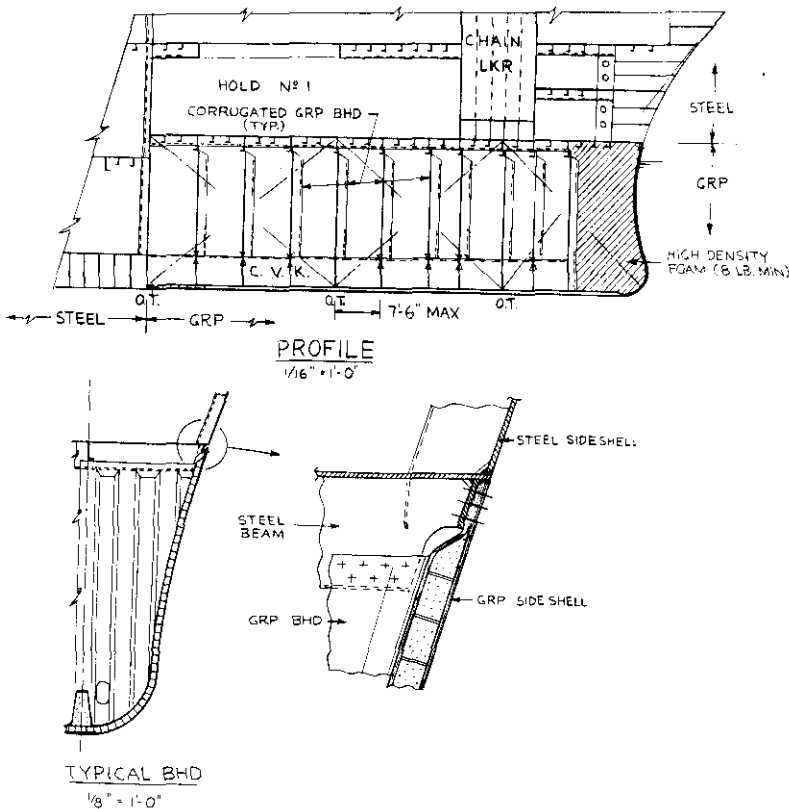

FIGURE 13

POSSIBLE GRP BOW MODULE

offset by lower weight (about 40-45 per cent reduction) allowing additional cargo capacity, reduced maintenance and inexpensive integrally molded insulation for reefer barges.

It is expected that these barges will be in quantity production and in service competing with equivalent steel barges in late 1971, and their relative performance will be carefully monitored.

SUMMARY

The concept of using GRP for large structural components on a steel cargo ship is technically feasible, and appears to be economically attractive in most cases. This reflects the fact that shapes which are relatively complex to fabricate from steel can be fabricated from GRP for little more than uncomplicated structures. This is the fundamental reason that the economics of GRP components are more attractive than for the ship as a whole. This also resulted from reduced maintenance, as well as the relatively high cost penalty which can be accepted for GRP if the weight savings can be converted to additional earning capacity at least 70 per cent of the time. This latter assumption is questionable in many cases however. If a cargo ship is carrying light density cargo and is volume-limited, it would not be possible to utilize the extra available weight unless deck containers are carried. Also, it often happens that the amount of cargo available at the dock is limited, and extra available deadweight is wasted. Thus, the potential economic benefits of GRP will not be achievable at all times.

It would appear that GRP components would be economically justifiable only if the over-all weight savings is appreciable. For a very small savings, the difference in vessel draft would be so small as to be indistinguishable when reading drafts. Thus, additional cargo, if available, would be carried, whether the weight savings is available or not. If the savings is appreciable, however, there would be a distinguishable and thus usable difference in vessel draft, allowing the stowage of additional cargo before limiting drafts are exceeded.

On the above basis, it would appear that further consideration should be given to GRP LASH barges, bow modules, king posts and hatch covers. These items represent a combined potential weight saving of several hundred tons in a high maintenance area. These components can also be instrumented to provide valuable data on their long term performance as an integral part of a large ship structure.

Further consideration of GRP deckhouses is questionable, because of the problem of combustibility. It appears that the reduced weight and lower life cycle cost of a GRP deckhouse relative to one of steel may not justify acceptance of a greater fire risk, when metal deckhouses of approximately equal weight and cost can be built which satisfy current U.S. Coast Guard regulations.

VIII. RECOMMENDED AREAS FOR FURTHER STUDY

GENERAL CONSIDERATIONS

One of the results of a limited feasibility study such as this, is that numerous questions are raised which cannot be satisfactorily answered within the time or cost allocated to the study. The GRP cargo ship study is typical in this regard, and the following paragraphs delineate the major areas requiring further study.

The following nine major areas requiring further study are discussed in this section, in the chronological order suggested for the inception of new research work:

- o GRP Structural Components
- o Costs
- o Materials
- o Fire Protection
- o Design Criteria
- o Deflections
- o Fabrication Procedures
- o Quality Control and Inspection
- o Maintenance and Repair Costs
- o Structural Details

As a part of the discussion, each of the proposed areas is evaluated relative to the following:

- o Likelihood of accomplishment.
- o Value of the output from additional studies relative to the time and cost for the studies, i.e. rate of return on R and D investment.

The suggested order of priority is somewhat arbitrary, and is based upon the assumption that the economic feasibility of a GRP cargo ship is presently more questionable than the technical feasibility. However, these two areas cannot truly be separated, since it can likewise be argued that there is no point in investigating economics until the technical feasibility is fully proven. At this time, there are four major areas in which technical feasibility has not been fully demonstrated: fire protection, design criteria, hull girder deflection, and material properties and capabilities.

Therefore, if further studies of a GRP cargo ship are to be considered, it is suggested that these four studies be conducted jointly with the cost studies since all five studies must be completed before greater confidence in the feasibility of a GRP cargo ship can be achieved.

GRP STRUCTURAL COMPONENTS

The GRP structural components evaluated in Section VII appear to be the best potential application of GRP in merchant ship construction for several reasons:

- o They are technically feasible.
- o The use of a combustible material for secondary structures in non-living or non-working spaces may be acceptable if the risk of fire is low.
- o They appear to be more economically attractive than the concept of an all-GRP cargo ship.
- o They can be used in areas where their specific advantages can best be exploited.

The component which appears to offer the best potential technical and economic advantage is a frangible GRP bow module, designed to minimize the effects of a collision. Such a bow would offer a number of advantages in addition to the lower weight, cost and maintenance noted in Section VII, since it would result in reduced insurance rates, and would be in keeping with current policies regarding increasing safety at sea and reducing pollution resulting from oil spills caused by collision.

Other GRP components which deserve further consideration include LASH barges, king posts, and hatch covers.

The likelihood of accomplishing the objectives of such a study or series of studies is very high, since these initial investigations indicates that such components offer the best potential economic gains, and acceptance of GRP components by the shipbuilding industry is far more likely than on an all-GRP ship. The value of such studies should also be very high, since a significant R and D effort should not be required to thoroughly investigate and develop these components.

COSTS

The proposed cost studies involve two major areas: construction costs and life cycle costs.

Construction Costs. The cost of fabricating large GRP hulls or major components must be more fully defined to permit accurate construction cost estimates and trade-offs of alternative construction techniques. At present, it is necessary to use approximate over-all manhours-per-pound values to estimate labor costs and associated overhead, which do not permit the type of relatively sophisticated trade-offs required to optimize structural design. For example, it has been necessary to assume that current hand layup productivity rates would be applicable to larger hulls, with automation, pre-impregnation of reinforcement and mechanized material handling offsetting the inherent difficulty of wetting out and curing very large areas of thick laminate. Until this is proven, or more accurate information is made available, it will be impossible to improve cost estimates.

Other areas relating to construction costs which require further study include the following:

- o Need for environmental control during construction, particularly temperature and humidity limits.
- o Extent to which automation and mechanized materials handling can be justified, based upon anticipated procurement levels.
- o Relative advantages of laying up decks in place, as proposed, versus separate layup of large deck sections and secondary bonding of these sections to each other and to the hull.
- o Integration of the GRP facility into the basic workload and operational procedures of the shipyard.
- o Optimization of structural component fabrication, including hull erection sections, bulkhead panels, deckhouse, major foundations, etc. relative to the hull production sequence.
- o Further studies of tooling cost.

The requirements which must be met in order to achieve reasonable confidence in construction cost estimates for a GRP cargo ship would include, as a minimum, the following:

- o Preparation of preliminary contract drawings and outline specifications for the GRP hull structure.
- o Development of a fabrication procedure by knowledgeable people representing shipyards, GRP fabrication, materials, design, quality control and equipment installation.
- o Preparation of competitive bids by a minimum of two facilities which are both interested in such a program and capable of performing the necessary tasks.

Life Cycle Costs. These studies would incorporate the results of the construction cost studies, and would utilize an improved life cycle cost model to obtain more accurate relative Required Freight Rates. Although the model used in this study is reasonable for a preliminary study, a refined model is desirable, incorporating the following improvements:

- o Analysis of a break-bulk transportation system, rather than identical steel and GRP ships. The basic constraints would be available deadweight tonnage, stowage factor, schedule requirements for liner service and a fleet of baseline steel ships capable of handling these requirements. This provides the investigator the options of varying number, size and speed of GRP ships to best take advantage of reduced hull weight.
- o Refinement of deadweight utilization factors, i.e. ratio of available deadweight to cargo carried per voyage.

- o Consideration of fuel cost savings in partially loaded or ballast conditions.
- o Inclusion of port fees, cargo handling costs and other factors previously neglected.
- o Better evaluation of maintenance costs, including the effects of increasingly higher maintenance costs on ships as they age.
- o Further investigation of insurance costs for GRP ships.
- o Further studies of the optimum method of extending steel ship life to 30 years.

The likelihood of accomplishing the objectives of the construction and life cycle cost studies is fairly good, though the accuracy of subsequent construction cost estimates is highly dependent upon the development of complete guidance information to assist the shipyards in making their estimates. The rate of return on such a study would be very good, since the concept of feasibility of a GRP cargo ship is highly sensitive to the accuracy of the cost estimates.

MATERIALS

Further studies are required to justify the selection of the proposed resins and reinforcements, particularly since experience with the proposed unidirectional reinforcements has been relatively limited to date in GRP hull fabrication.

Such data can be obtained, by a combination of design analysis and testing, and will serve to provide basic material properties to proceed with further structural and economic studies.

The steps required to acquire these data include the following:

- o Investigate alternatives to the composite unidirectional woven roving laminate suggested, including use of bias plies of unidirectional reinforcement for strength in a transverse and diagonal direction, and use of a thin layer of mat between plies of unidirectional or woven roving material to improve interlaminar shear strength.
- o Optimize warp-fill relationships for primary hull girder laminates and those of secondary structures.
- o Develop, conduct and evaluate a test program to obtain laminate physical properties data and layup rates for laminate compositions selected. This would include static properties, fatigue strength, wet strengths, impact strength, notch sensitivity, abrasion resistance and creep properties.
- o Select optimum laminates for various hull components, based upon weight/strength and strength/cost relationships. This would include studies of alternative high-performance laminates for use in areas requiring high strength and stiffness, including higher strength glass, boron or graphite filaments and "Wire

Sheet", which utilizes fine, high strength unidirectional steel wires in combination with fiberglass reinforcement and polyester resin.

The likelihood of accomplishing these objectives is excellent, as is the rate of return, since a properly developed materials test and evaluation program can provide a satisfactory level of confidence in those areas which are now questionable.

FIRE RESISTANCE

The entire question of the effects of GRP's combustibility must be thoroughly analyzed to determine to what extent it would be acceptable in future merchant ship designs. This study indicates that further investigations of fire resistance should be directed primarily toward GRP components, due to the questionable economic viability of an all-GRP ship. These studies should include the following:

- o Discussions with U. S. Coast Guard to determine which potentially attractive GRP components would be acceptable within the present requirements for fire resistance.
- o Investigate necessary improvements in detection and extinguishing equipment which would be required if GRP components are used.
- o Evaluate toxicity problems.

The likelihood of accomplishing these objectives is fairly good, though extensive consultation with U.S. Coast Guard will be required. The rate of return on further studies of fire resistance should be good, since fire protection is one of the most critical technical problems to be resolved in connection with the use of GRP on merchant ships.

DESIGN CRITERIA

Many of the criteria established in this study for designing the GRP hull structure have been based upon a conservative estimate of the material's ability to withstand the life cycle environment as well as an equivalent steel hull. Sensitivity studies have demonstrated that these conservative assumptions have a significant effect on the economics of the GRP ship, and the following require further study:

- o The relative significance of fatigue strength in establishing hull girder section modulus requirements, including consideration of relative strength retention in the low cycle range ($10^3 - 10^5$) and the high cycle range ($10^5 - 10^8$).
- o The relative significance of wet strength, material property variability, impact strength, abrasion resistance, non-yielding behavior and creep in establishing safety factors.
- o Comparison of GRP scantlings when derived by theoretical analysis versus those converted from accepted steel scantlings.
- o Deflection limits for local structures such as deck panels and girders.

- o Discussion of criteria with ABS, Lloyds and other regulatory bodies.

The likelihood of accomplishing these objectives is quite high, since it is primarily a function of reviewing additional material properties data and applying sound engineering judgment in their interpretation. The rate of return would also be quite high due to the importance of these criteria in selecting hull scantlings.

DEFLECTIONS

It was previously noted that the hull girder deflection of a strength-critical GRP cargo ship will be between 4 and 5 times that of an equivalent steel ship. It is obvious that any arbitrary increase in scantlings to increase stiffness will have a detrimental effect on the weight, cost and earning capacity of the GRP ship. Therefore it is vital that further studies be initiated to determine the acceptability of these large deflections, considering such factors as:

- o Stresses at secondary bonds due to rotation of structural elements at supports.
- o Hull girder and local structural vibrations.
- o Response to sea-induced forces.
- o Effects on systems, such as cables, piping and vent ducts and on propulsion shafting.
- o Effects on tightness of hatch covers.
- o Psychological factors.
- o Effects on limiting draft and freeboard.

In conjunction with these studies, methods of minimizing still water bending moment and associated still water deflections should be investigated, as well as the validity of assumed deflection limitations on local structural elements such as panels and beams. Studies of high-modulus reinforcements for the deck and keel are also proposed.

The success of these studies depends largely upon the willingness of regulatory bodies to accept larger hull girder deflections than normal if they appear technically justifiable. If tighter deflection limitations are arbitrarily imposed on the GRP hull, there would be no point in giving further consideration to a GRP cargo ship, since GRP is a poor choice of materials for a deflection-limited structure.

The likelihood of accomplishing these objectives is quite good, and again the rate of return would be high since deflection problems are a major technical concern at this time.

FABRICATION PROCEDURES

In the previous discussion of fabrication facilities and procedures, it was noted that the proposed construction procedure was an attempt to present one method which appeared feasible and, within the effort devoted to this study, reasonably close to optimum.

As noted, numerous variations on this procedure are possible, and perhaps more desirable. Such alternatives should be evaluated in detail, with consideration given to the following factors, as a minimum:

- o Molding methods for hull and major structural components.
- o Suitable reinforcement, wet-out and cure cycles to achieve reliable interlaminar and intralaminar structural characteristics.
- o Material handling and distribution, including impregnation techniques and cycles; extent to which automation is justified.
- o Sectionalized versus one-piece construction of the hull and major components.
- o Construction of the GRP hull and components of an existing shipyard versus use of a separate GRP facility.
- o Further structural optimization, including studies of integral versus non-integral tanks, single skin versus sandwich construction, etc.
- o A suitably rigid quality control procedure to assure fabrication of sound laminates and joints.

The likelihood of accomplishing these objectives is quite high, though the required level of effort for such studies is difficult to determine at this time, since the potential rate of return is highly variable. A limited effort in this area, involving a qualitative evaluation of various alternatives, would be a valuable adjunct to the construction cost studies previously proposed. If the concept of a GRP cargo ship remains attractive after closer examination, each of these areas could be examined in greater detail to determine their relative merits.

Each study should include development of sketches and narratives in sufficient detail to allow the estimating shipyards to assess the relative differences on the over-all cost and schedule of the proposed procurement program.

QUALITY CONTROL AND INSPECTION

The question of quality control and inspection of GRP laminates is extremely important, for, as stated previously, state-of-the-art methods are often inadequate for larger hulls with thicker laminates. Hopefully, the U.S. Navy, British Admiralty and SNAME studies now being conducted in this area will provide guidance in the near future.

The likelihood of accomplishing the set objectives and achieving a high rate of return for the R and D effort in this area is somewhat questionable, since there is presently little incentive to invest the money and time necessary to fully evaluate the problem and achieve viable solutions. Most of the GRP fabrication requiring very careful control, such as in the aerospace industry, involves relatively small components fabricated under carefully controlled conditions. The GRP boatbuilding industry represents the other end of the spectrum, where the gradual extension of small boat quality assurance and inspection procedures to larger hulls has been accepted and, to a reasonable extent, proven satisfactory.

These factors reinforce the previous discussions wherein it was proposed that efforts in this direction be aimed at minimizing the causes of quality variability at the source, through such procedures as preimpregnating laminates to achieve satisfactory confidence in resin-to-glass ratios. This, in conjunction with improvements in non-destructive testing, should form a suitable basis for controlling the quality of GRP structures for larger hulls.

The R and D effort in this area should be directed initially at determining the true causes and effects of GRP structural deficiencies, rather than at their detection and correction. This would include consideration of material property variability, effects of foreign matter, void content and gel time variation on laminate quality, effects of secondary bonds, overlaps, discontinuities and hard spots on strength, etc. Many of these factors are presently being evaluated in conjunction with the United States and British GRP minesweeper studies, and may eliminate much of the controversy as to the effects of these factors.

MAINTENANCE AND REPAIR COSTS

Reduced hull maintenance and repair costs are a key factor in selecting GRP in many marine applications. Further studies are required to evaluate more accurately the life cycle M and R cost of a GRP cargo ship hull for comparison to the equivalent steel hull. This is particularly important as the ships get older, since the costs of steel hull repairs begin to increase rapidly as plate replacement becomes necessary.

The probability of accomplishing the objectives of such a study is somewhat doubtful, for several reasons. First, it would be necessary to extrapolate the M and R history of older small GRP boats to the large cargo ship. Alternatively, it would be necessary to extrapolate the relatively limited and poorly documented M and R history of larger GRP vessels such as trawlers. In either case, such extrapolation is both difficult and dangerous, since the GRP cargo ship presents potential M and R problems not yet encountered with smaller hulls.

Therefore it can be assumed that the rate of return on further investigations into GRP cargo ship M and R cost will be relatively low since they would be expected to improve only slightly upon the values presented in this report. The true picture will not be obtained until such a vessel is in service.

STRUCTURAL DETAILS

The present study has been primarily concerned with the development of

primary hull structural elements for a GRP cargo ship, with relatively little attention given to design details. As the design and study effort progresses, however, it becomes increasingly more important to give careful consideration to the more critical structural details. This study would consider the following as a minimum:

- o Secondary bonding of major structural components.
- o Installation of major pieces of equipment such as gears, turbines, boilers, generators, typical winches, king posts, steering gear and other similar items.
- o Rudder attachment.
- o Stiffener attachments.
- o Required corner radii, particularly in way of hatch cuts.

The likelihood of accomplishing the objectives of such a study is quite high, but the direct return on the investment will not be particularly high during a feasibility study, where such details are generally not given major consideration. However, such studies would provide valuable guidance in further construction cost studies.

IX. CONCLUSIONS AND RECOMMENDATIONS

CONCLUSIONS

The conclusions to be derived from this Feasibility Study for a GRP cargo ship are summarized below.

General. The construction of a cargo ship utilizing GRP for the hull structure is technically feasible within the present state-of-the-art, but the long-term durability of the structure is questionable and the concept is not economically justified in direct competition with a steel vessel of equivalent capabilities. The combustibility of GRP is also unacceptable.

The use of GRP for major structural components is technically feasible and appears to be economically attractive for some components if they are procured in sufficient quantity, and if limited use of combustible materials is acceptable.

GRP Materials. The resins, reinforcements and core materials presently available, or modifications thereof, are technically acceptable for building larger GRP hulls than those now in service or in development, up to perhaps 250 or 300 feet in length. However, there is no conclusive evidence to establish the long-term durability and capabilities of state-of-the-art GRP laminates and core materials when used in much larger hulls, such as a cargo ship. It is not considered reasonable to extrapolate current knowledge of GRP durability to such large hulls without considerable additional testing and analysis. Therefore, the technical feasibility of GRP materials for this application cannot be fully demonstrated at this time.

GRP laminates are available with adequate short-term properties. However, the lack of stiffness of GRP must be recognized, and careful attention must be given to material property variability, loss of strength due to immersion in water and long-term aging, creep, fatigue, impact strength, abrasion resistance and secondary bonding.

Structural Concepts. Single skin construction using either woven roving or a composite of woven roving and unidirectional reinforcement is recommended for general application to a GRP cargo ship, though sandwich construction is preferable for large flat deck panels where over-all deflection limitations become critical.

Longitudinal framing is generally preferred, to minimize shell and deck laminate buckling problems. Transverse framing is recommended for the side shell to avoid the need for web frames and to provide greater protection when the shell bears up against piers or floats.

Operational Experience with Existing GRP Vessels. The operational experience to date with existing GRP vessels up to about 100 feet in length is very good. The resistance to the environment is excellent, though some minor problems have been encountered with impact, abrasion and secondary bonds.

Repairs to GRP structures are generally accomplished quite easily, though the integrity of such repairs, particularly for large hull sections, is sometimes questionable. The maintenance history of GRP hulls has been excellent. Maintenance is generally limited to renewal of antifouling paint, cosmetic painting and topside repairs.

Fabrication Facilities and Procedures. The basic requirements for a facility to fabricate a GRP cargo ship suggest the use of an existing shipyard as a base, with a special GRP facility constructed on the site, providing necessary environmental control and specialized equipment and material storage areas.

A fabrication procedure can be developed and optimized which is suitable for a large GRP hull. Steel tooling can be utilized to minimize costs, which will be approximately 2/3 the cost of the hull structure for one ship.

Present quality control and inspection procedures must be improved and modified to suit larger GRP hulls with exceptionally thick laminates and sandwich panels. Maximum use of mechanized preimpregnating equipment, close environmental control and ultrasonic laminate inspection is recommended to reduce problems with GRP quality.

Fire Resistance. GRP is a combustible material, even with fire-retardant additives in the resin. For this reason, it is unacceptable for use in structural applications under current U.S. Coast Guard regulations. Thus a GRP cargo ship is not now technically feasible. Any future proposal to use GRP must clearly justify any intention to revise today's standards based on proven superior economic and technical advantages.

Installation of Systems and Equipment. Installation of systems and equipment in a GRP hull is relatively easy, though loads should be well distributed. All shipbuilding materials are compatible with GRP hull structure. The flexibility of the GRP hull must be considered in designing piping and duct systems, particularly those with long runs in the fore and aft direction.

Operational Characteristics of a GRP Cargo Ship. The use of pigmented resins will reduce topside maintenance, but renewal of antifouling paint will be required below the waterline. Drydock cycles will be the same as with steel ships. Special hull surveys may be required more often than with steel ships.

Repairs may be more difficult to accomplish, due to lack of trained personnel and difficulties in returning the damaged area to required strength. The higher cost of repairs and vessel replacement will increase hull insurance costs for GRP ships.

Design Criteria. Existing regulatory body design criteria for GRP vessels cannot be extrapolated to large cargo ship hulls. However, rational and justifiable design criteria can be established for the strength requirements of the hull girder and local structures of a GRP cargo ship. In general these criteria are based upon modification of proven steel scantlings to GRP, on the basis of relative ultimate strength ratios, with corrections for GRP property variability, long-term durability, non-yielding nature, creep, and loss of strength when immersed.

Restrictions on hull girder deflection have not been imposed, since there is no rational justification for such limits. However, the effects of hull deflection on its own strength and ship systems, must be carefully analyzed, and steps taken to minimize hull girder bending moment and deflection.

Design of GRP Cargo Ship. The principal dimensions of the GRP cargo ship selected for this study are identical to the baseline steel ship, to facilitate direct comparison. The GRP hull utilizes discontinuous steel hatchside girders, which are not a part of the hull girder strength, to satisfy local deflection limitations.

Both woven roving and composite unidirectional/woven roving GRP designs were considered. However, the woven roving design proved to be slightly heavier than steel and higher in cost, and further consideration was unwarranted.

The weight per foot of the composite GRP section is 0.57 times that of the steel ship, and the stiffness is one-fifth. This deflection is far higher than would presently be accepted, and may require increasing hull depth, use of high modulus material in the deck and bottom and optimizing of weight distribution to reduce deflection. Further studies of the effects of hull deflection on strength of joints and hull systems are required to establish rational limits.

The total weight of the hull structure was reduced from 3394 long tons for the steel ship to 2034 long tons for the GRP ship, a savings of 40 per cent. The reduction in light ship is from 5786 to 4339 long tons; a savings of 25 per cent. The stability of the GRP ship is slightly better in all but the lightest conditions, where additional ballast is required.

Cost Studies. The cost analyses for this study represent the best possible estimate of realistic construction and operational costs, based upon the information presently available. These studies indicate that a GRP cargo ship similar to the SS JAMES LYKES has a higher required freight rate (RFR) than an equivalent steel ship, regardless of the vessel life (20 or 30 years), level of procurement (1 to 10 identical hulls), and minimum assumed GRP fabrication costs. Thus the greater earning capacity of the GRP hull is not sufficient to offset its higher initial cost.

Sensitivity studies indicate that the use of more optimistic design and cost analysis criteria can, in some cases, make the GRP ship marginally competitive with equivalent steel ships, for a procurement of 5 or more ships. However, the uncertainty of realizing these more optimistic assumptions, as well as the lack of a clear economic advantage for GRP, cannot justify the risk involved in pursuing its development at this time.

Alternative Types of Large GRP Ships. Life cycle cost studies of alternative types of large GRP ships, including container ships, bulk carriers and tankers, result in relative GRP-steel cost comparisons quite similar to the cargo ship. Thus further consideration of GRP for other types of large ships is also unwarranted at this time. However, small coastal vessels in the 150-250 foot range may be economically justified and warrant further study.

Large GRP Structural Components. A number of GRP structural components were investigated for incorporation on a steel cargo ship, including deck-house, hatch covers, king posts and others. In general, the weight savings resulting from using GRP composite laminates in lieu of steel is between 50 and 60 per cent.

Although the cost of these GRP components is higher than the equivalent steel component, this higher cost can be justified on the basis of increased life cycle earning capacity. However, these savings will only be realized

if the lower weight resulting from the use of GRP can be utilized for additional cargo capacity.

Recommended Areas for Future Research. Further research is required in the areas of construction cost and procedures, material properties, fire resistance, quality control and inspection, design criteria, deflections, long-term durability, maintenance and repair costs.

RECOMMENDATIONS

On the basis of the foregoing conclusions the following recommendations are offered:

- o Further effort toward the development of GRP cargo ships or other large GRP ships is not warranted and should not be reconsidered until improved GRP materials at lower costs and experience in long-term durability on the present larger GRP trawlers and the British 153 foot minehunter under construction are obtained.
- o The technical feasibility of smaller GRP cargo ships, offshore supply vessels, and other types of ships up to 300 feet long is justified on the basis of both the United States and British minesweeper programs and should be investigated. Similarly, the feasibility of other large GRP ships such as fishing trawlers, ferriers, naval auxiliaries and gunboats looks very promising and should be investigated. The question of fire resistance must be carefully considered prior to such studies, however.
- o Research into the areas previously delineated for further studies should be initiated, since these studies would directly affect the future of the larger GRP hulls.
- o Research into light weight hulls should continue, since the potential economic gains appear attractive if the risks involved in building and operating the vessel can be minimized.
- o The higher strength and stiffness properties of the more sophisticated laminates and composites should be investigated for use on weight sensitive craft such as hydrofoils and air cushion vehicles.

LIST OF REFERENCES

- (1) R.J. Scott, J.H. Sommella, "FRP Trawlers - Design and Fabrication in the United States", 26th Annual Technical Conference, The Society of the Plastics Industry, Inc.
- (2) H.R. Hallet, J.S. Simpson, "Fabrication of Large FRP Trawlers", 23rd Annual Technical Conference, The Society of the Plastics Industry, Inc.
- (3) B. Cobb, Jr. "Evaluation of Fiberglass Construction for Commercial Fishing Hulls", 23rd Annual Technical Conference, The Society of the Plastics Industry, Inc.
- (4) A. Lippay, R. Levine, "End Grain Balsa Cored Reinforced Plastic as a Fishing Vessel Construction Material", Conference on Fishing Vessel Construction Materials, Montreal, Canada, October 1968
- (5) B. Cobb, Jr. "Design, Construction and Economic Considerations in Fiberglass Trawler Construction", Conference on Fishing Vessel Construction Materials, Montreal, Canada, October 1968
- (6) R.J. Della Rocca "Fiberglass Reinforced Plastic 110 Foot Trawler", presented October 1965 at Gothenberg, Sweden, Third F.A.O. Technical Conference on Fishing Boats
- (7) K.B. Spaulding, R.J. Della Rocca "Fiberglass Reinforced Plastic Minesweepers", Society of Naval Architects and Marine Engineers, 1965
- (8) W.R. Graner, R.J. Della Rocca, "Evaluation of U.S. Navy GRP Boats for Material Durability", 26th Annual Technical Conference, The Society of the Plastics Industry, Inc.
- (9) "Marine Design Manual for Fiberglass Reinforced Plastics", Gibbs & Cox, Inc., McGraw-Hill Book Co., 1960
- (10) Society of Naval Architects and Marine Engineers, T&R Bulletin 2-12, "Guide for Selection of Fiberglass Reinforced Plastics for Marine Use", 1965
- (11) "Applications for 'Liaisil'", Refortee N/V, Eindhoven, Holland
- (12) "Rigidcell-Rigid Vinyl Foam Data Sheet" B.F. Goodrich Co.
- (13) Airex Ltd. Data Sheet E8/52 "Ultimate Stress Values of Airex-Rigid"
- (14) "Materials Engineering - Materials Selector Issue" Mid-November 1970
- (15) "Belco - The Superior Core for Sandwich Structures", Balsa Ecuador Lumber Co. Data Sheet

LIST OF REFERENCES (Cont'd)

- (16) R.J. Della Rocca, R.J. Scott, "Materials Test Program for Application of Fiberglass Reinforced Plastics to U.S. Navy Minesweepers", 22nd Annual Technical Conference, The Society of the Plastics Industry, Inc.
- (17) N. Fried and W.R. Graner, "Durability of Reinforced Plastic Structural Materials in Marine Service", Vol. 3, No. 3, July 1966 Marine Technology (SNAME)
- (18) "Third International Ship Structures Congress - Volume II - Report on Plastics in Shipbuilding", Det Norske Veritas, 15 September 1967
- (19) "Marine Survey Manual for Fiberglass Reinforced Plastics", Gibbs & Cox, Inc., 1962
- (20) T.P. 1625, "Maintenance and Repair Manual for Coast Guard Plastic Boats", CG-339-1, United States Coast Guard, Treasury Department
- (21) Cobb, Boughton, Jr., "Fiberglass Boats Construction and Maintenance", Reprinted from "Yachting" by Owens-Corning Fiberglas Corporation, Fiberglas Reinforced Plastics Division, New York, N.Y.
- (22) Ferro Corporation, "Care and Repair of Fiberglass Boats", Fiber Glass Division, Ferro Corporation, Nashville, Tenn. 37211
- (23) Owens-Corning Fiberglas Corporation, "Repair Guide for Fiberglas Reinforced Molded Boats", Owens-Corning Fiberglas Corporation, Fiberglas Reinforced Plastics Division, New York, N.Y.
- (24) NavShips 250-346-4, "Reinforced Plastics Preventive Maintenance and Repair Manual", Navy Department, Bureau of Ships, Washington, D.C. 20360, 1960
- (25) "Design Considerations for Aluminum Hull Structures - Study of Aluminum Bulk Carrier - Final Technical Report", Gibbs & Cox Report No. 16671/(1-598) dated November 1970
- (26) Spaulding, K.B. "Cored Fiberglass Reinforced Hull Construction," Conference on Fishing Vessel Construction Materials, Montreal, Canada, October 1968
- (27) Lloyd's Register of Shipping "Provisional Rules for the Application of Glass Reinforced Plastics to Fishing Craft"
- (28) Det Norske Veritas "Forslag Til Retningslinjer For Bygging Av Plastfartoyer" ("Proposal for Guidance in Building Fiberglass Ships")
- (29) Bureau Veritas "Coques en Polyester Renforce de Verre Textile" ("Hulls of Polyester Reinforced Fiberglass")

LIST OF REFERENCES (Cont'd)

- (30) Registro Italiano Navale "Regolamento Provvisorio per la Costruzione delle Imbarcazioni da Diporto in Plastica Rinforzata" ("Provisional Regulations for the Construction of Pleasure Boats in Reinforced Plastic")
- (31) Fetchko, J.A. "Shipbuilding Cost and Price Indices" Prepared for the University of Michigan's Engineering Summer Conference on Economics in Ship Design and Operation, June 24-28, 1968, Ann Arbor, Michigan
- (32) Fetchko, J.A. "Method of Estimating Investment Costs of Ships" Lecture Notes for Intensive Course in Economics in Ship Design and Operation - University of Michigan Engineering Summer Conferences, June 1968
- (33) H. Benford "General Cargo Ship Economics and Design", The University of Michigan, College of Engineering, Department of Naval Architecture and Marine Engineering, August 1965
- (34) H. Benford "Measures of Merit for Ship Design" Marine Technology, October 1970
- (35) Computer Printout of Maintenance Cost Data Supplied by the Performance Evaluation Branch, Office of Ship Construction, Maritime Administration, Washington, D.C.
- (36) R.J. Scott, "Containership Design" Great Lakes and Great Rivers Section of the Society of Naval Architects and Marine Engineers, January 1962

APPENDIX A

DETERMINATION OF MAXIMUM ACQUISITION COST OF GRP COMPONENTS
FOR EQUIVALENT LIFE CYCLE COST WITH STEEL COMPONENT

BASIC ASSUMPTIONS FOR STUDY

The baseline for this study is the steel cargo ship SS JAMES LYKES, with all procurement costs updated to 1970 price levels, and an assumed procurement level of 5 ships.

Procurement cost = \$13,500,000 (Table 21, body of Report).

Vessel life of 20 years assumed. Life of GRP component to be similar to that for steel hull, machinery and equipment.

The higher cost of insuring and repairing a GRP component offsets the reduced maintenance cost. Higher GRP repair costs are assumed, since the limited use of GRP on a steel cargo ship will not generate a GRP repair capability in the world's shipyards. Thus repairs to GRP components could require more time and cost than those for equivalent steel repairs due to lack of experience.

Neglect all factors which are constant for this study, such as crew and subsistence, drydock and layup and cargo handling. Scrap value is also neglected.

All other economic criteria, including the economic model for evaluating Required Freight Rate, to be identical to those in the body of the Report.

PROCEDURE

This study was conducted on the basis of replacing a 100 ton steel component with equivalent GRP, and assuming a weight savings of 40, 50 and 60 per cent, which is a reasonable range. The 40, 50 and 60 ton weight savings, respectively, was converted to increased cargo deadweight with a 70 per cent utilization factor. Thus the average deadweight increase utilized is 0.7 times the available increase.

The Required Freight Rates for the baseline steel ship and that with GRP components were determined, leading to the allowable increase in cost per pound of a GRP component relative to the equivalent steel component cost per pound for equal RFR.

RESULTS

The results of this analysis are shown in Table A-1, which indicates that the acquisition cost per pound of GRP components can be increasingly greater than that of the equivalent steel component as its weight ratio diminishes.

TABLE A-1

ALLOWABLE INCREASE IN ACQUISITION COST OF GRP COMPONENTS

	All-Steel Ship	Steel - GRP Composite Ship (100 Tons of Steel Replaced)		
		40 Ton Saving	50 Ton Saving	60 Ton Saving
1. Light Ship Weight, Long Tons	5786	5746	5736	5726
2. Annual Cargo Carrying Capacity, Long Tons	143,000	143,670	143,840	144,010
3. Acquisition Cost Per Ship, \$	13,500,000	13,563,040	13,579,160	13,595,200
4. Cost of Capital Recovery, \$	1,943,300	1,952,400	1,954,720	1,957,030
5. Required Freight Rate = 5 ÷ 2, \$/Ton	13.5895	13.5895	13.5895	13.5895
6. Maximum Difference in Acquisition Cost, \$	-	63,040	79,160	95,200
7. Weight of GRP Component, Lb.	-	134,400	112,000	89,600
<u>For Steel at \$0.40/Lb.</u>				
8. Cost of Steel Component, \$		89,600	89,600	89,600
9. Maximum Cost of GRP Component, \$		152,640	168,760	184,800
10. Maximum Cost of GRP, \$/Lb.		1.14	1.51	2.06
11. Maximum Cost Premium, \$/Lb.		0.74	1.11	1.66
<u>For Steel at \$0.60/Lb.</u>				
12. Cost of Steel Component, \$		134,400	134,400	134,400
13. Maximum Cost of GRP Component, \$		197,440	213,560	229,600
14. Maximum Cost of GRP, \$/Lb.		1.47	1.91	2.56
15. Maximum Cost Premium, \$/Lb.		0.87	1.31	1.96
<u>For Steel at \$0.80/Lb.</u>				
16. Cost of Steel Component, \$		179,200	179,200	179,200
17. Maximum Cost for GRP Component, \$		242,240	258,360	274,400
18. Maximum Cost of GRP, \$/Lb.		1.80	2.31	3.06
19. Maximum Cost Premium, \$/Lb.		1.00	1.51	2.26

DOCUMENT CONTROL DATA - R & D

(Security classification of title, body of abstract and indexing annotation must be entered when the overall report is classified)

1. ORIGINATING ACTIVITY (Corporate author)		2a. REPORT SECURITY CLASSIFICATION	
Gibbs & Cox, Inc. New York, N. Y.		Unclassified	
3. REPORT TITLE		2b. GROUP	
Feasibility Study of Glass Reinforced Plastic Cargo Ship - Final Technical Report			
4. DESCRIPTIVE NOTES (Type of report and inclusive dates)			
Final Technical Report			
5. AUTHOR(S) (First name, middle initial, last name)			
Robert J. Scott John H. Sommella			
6. REPORT DATE		7a. TOTAL NO. OF PAGES	7b. NO. OF REFS
August 1971		120	36
8a. CONTRACT OR GRANT NO.		9a. ORIGINATOR'S REPORT NUMBER(S)	
N00024-70-C-5374		Gibbs & Cox 16811/(1-429)	
b. PROJECT NO.		9b. OTHER REPORT NO(S) (Any other numbers that may be assigned this report)	
		SSC-224	
10. DISTRIBUTION STATEMENT			
No. 1 - Distribution of this document is unlimited			
11. SUPPLEMENTARY NOTES		12. SPONSORING MILITARY ACTIVITY	
		Naval Ship Systems Command	
13. ABSTRACT			
<p>This study was undertaken to evaluate the technical and economic feasibility of constructing and operating a large glass reinforced plastic (GRP) cargo vessel or, alternatively, using GRP for major structural components on a steel cargo ship.</p> <p>The design and fabrication of a large GRP cargo ship is shown to be totally within the present state-of-the-art, but the long term durability of the structure is questionable. Additional research is required to establish satisfactory confidence in material properties. Experience with existing large GRP vessels is reviewed and extrapolated, where possible, to the large GRP cargo ship. Criteria for the design of the GRP hull structure are presented and justified. Methods of system/equipment installation are reviewed.</p> <p>GRP ship structures are unacceptable under present U.S. Coast Guard fire regulations requiring the use of incombustible materials. GRP must promise superior economic and technical advantages to warrant consideration of revising these requirements.</p> <p>The design of a large GRP cargo vessel utilizing a composite unidirectional-woven roving laminate is presented and compared to the equivalent steel ship. The saving in the structural weight of the GRP ship is 40 per cent. The hull is five times as flexible as the steel hull.</p> <p>Cost studies indicate that, for the same return on investment, the Required Freight Rate of the GRP cargo ship is higher than that of the equivalent steel ship for all levels of procurement, hull life and for various laminate layup rates considered. Similar studies of container ships and bulk carriers arrive at similar conclusions. However, major structural components such as deckhouses, hatch covers, king posts and bow modules are shown to be economically justified in some cases.</p> <p>Areas for further research are presented, and further investigations of smaller GRP vessels (150-250 feet long) are proposed since these appear most promising at this time.</p>			

14 KEY WORDS	LINK A		LINK B		LINK C	
	ROLE	WT	ROLE	WT	ROLE	WT
Final Technical Report						
Fiberglass Reinforced Plastic						
Glass Reinforced Plastic (GRP)						
Reinforced Plastic						
Cargo Ships						
Study - GRP Cargo Ships						
Material Studies - GRP Cargo Ships						
Fabrication - GRP Cargo Ships						
Design Studies - GRP Cargo Ships						
Ship Design - GRP Cargo Ships						
Cost Studies - GRP Cargo Ships						
Feasibility - GRP Cargo Ships						
Structural Components - GRP						
Fire Resistance - GRP						

SHIP RESEARCH COMMITTEE
Maritime Transportation Research Board
National Academy of Sciences-National Research Council

The Ship Research Committee has technical cognizance of the inter agen
Ship Structure Committee's research program:

PROF. R. A. YAGLE, Chairman, *Prof. of Naval Architecture, University of Michigan*
DR. H. N. ABRAMSON, *Director, Dept. of Mechanical Sciences, Southwest Research Inst*
MR. W. H. BUCKLEY, *Chief, Structural Criteria and Loads, Bell Aerosystems Co.*
MR. E. L. CRISCUOLO, *Senior Nondestructive Testing Specialist, Naval Ordnance Labor*
DR. W. D. DOTY, *Senior Research Consultant, U. S. Steel Corporation*
PROF. J. E. GOLDBERG, *School of Engineering, Purdue University*
PROF. W. J. HALL, *Professor of Civil Engineering, University of Illinois*
MR. J. E. HERZ, *Chief Structural Design Engineer, Sun Shipbuilding & Dry Dock Co.*
MR. G. E. KAMPSCHAEFER, JR., *Manager, Application Engineering, ARMCO Steel Corporat*
MR. R. C. STRASSER, *Director of Research, Newport News Shipbuilding & Dry Dock Comp*
CDR R. M. WHITE, USCG, *Chief, Applied Engineering Section, U. S. Coast Guard Academ*
MR. R. W. RUMKE, *Executive Secretary, Ship Research Committee*

Advisory Group II, "Ship Structural Design" prepared the project prosp
and evaluated the proposals for this project.

MR. J. E. HERZ, Chairman, *Chief Structural Design Engr., Sun Shipbuilding & Dry Doc*
MR. C. M. COX, *Asst. Naval Architect, Newport News Shipbuilding & Dry Dock Company*
MR. C. R. CUSHING, *President, Cushing & Nordstrom, Inc.*
PROF. J. E. GOLDBERG, *School of Engineering, Purdue University*
PROF. J. R. PAULLING, JR., *Chairman of Dept. of Naval Architecture, Univ. of Calif.*
MR. D. P. ROSEMAN, *Naval Architect, Hydronautics, Inc.*
CDR R. M. WHITE, USCG, *Chief, Applied Engineering Section, U. S. Coast Guard Acade*

The SR-195 Project Advisory Committee provided the liaison technical
guidance, and reviewed the project reports with the investigator.

PROF. B. R. NOTON, Chairman, *Prof. of Aerospace & Civil Engineering, Washington Un.*
MR. C. R. CUSHING, *President, Cushing & Nordstrom, Inc.*
MR. D. P. COURTSAL, *Chief Marine Engineer, DRAVO Corporation*

SHIP STRUCTURE COMMITTEE PUBLICATIONS

These documents are distributed by the National Technical Information Service, Springfield, Va. 22151. These documents have been announced in the Clearinghouse journal U.S. Government Research & Development Reports (USGRDR) under the indicated AD numbers.

- SSC-212, *Ship Response Instrumentation Aboard the Container Vessel "S. S. BOSTON": Results from the 1st Operational Season in North Atlantic Service* by R. A. Fain, J. Q. Cragin, and B. H. Schofield. 1970. AD 712186.
- SSC-213, *A Guide for Ultrasonic Testing and Evaluation of Weld Flaws* by R. A. Youshaw. 1970. AD 713202.
- SSC-214, *Ship Response Instrumentation Aboard the Container Vessel "S. S. BOSTON": Results from Two Operational Seasons in North Atlantic Service* by J. Q. Cragin. 1970. AD 712187.
- SSC-215, *A Guide for the Synthesis of Ship Structures Part One - The Midship Hold of a Transversely-Framed Dry Cargo Ship* by Manley St. Denis. 1970. AD 717357.
- SSC-216, (To be published).
- SSC-217, *Compressive Strength of Ship Hull Girders - Part I - Unstiffened Plates* by H. Becker, R. Goldman, and J. Pozerycki. 1971. AD 717590.
- SSC-218, *Design Considerations for Aluminum Hull Structures: Study of Aluminum Bulk Carrier* by C. J. Altenburg, and R. J. Scott. 1971. AD 729021.
- SSC-219, *Crack Propagation and Arrest in Ship and Other Steels* by G. T. Hahn, R. G. Hoagland, P. N. Mincer, A. R. Rosenfield, and M. Sarrate. 1971.
- SSC-220, *A Limited Survey of Ship Structural Damage* by S. Hawkins, G. H. Levine, and R. Taggart. 1971.
- SSC-221, *Response of the Delta Test to Specimen Variables* by L. J. McGeady. 1971.
- SSC-222, *Catamarans - Technological Limites to Size and Appraisal of Structural Design Information and Procedures* by N. M. Maniar, and W. P. Chiang. 1971.
- SSC-223, *Compressive Strength of Ship Hull Girders - Part II - Stiffened Plates* by H. Becker, A. Colao, R. Goldman, and J. Pozerycki. 1971.