

SSC-231

**FURTHER STUDIES OF COMPUTER
SIMULATION OF SLAMMING AND
OTHER WAVE-INDUCED VIBRATORY
STRUCTURAL LOADINGS ON SHIPS IN WAVES**

**This document has been approved
for public release and sale; its
distribution is unlimited.**

SHIP STRUCTURE COMMITTEE

1972

SHIP STRUCTURE COMMITTEE

AN INTERAGENCY ADVISORY
COMMITTEE DEDICATED TO IMPROVING
THE STRUCTURE OF SHIPS

MEMBER AGENCIES:

UNITED STATES COAST GUARD
NAVAL SHIP SYSTEMS COMMAND
MILITARY SHIPREPAIR COMMAND
MARITIME ADMINISTRATION
AMERICAN BUREAU OF SHIPPING

ADDRESS CORRESPONDENCE TO:

SECRETARY
SHIP STRUCTURE COMMITTEE
U.S. COAST GUARD HEADQUARTERS
WASHINGTON, D.C. 20591

SR-174
1972

Dear Sir:

A major portion of the effort of the Ship Structure Committee has been devoted to improving capability of predicting the loads which a ship's hull experiences.

This report contains information on a method for predicting seaway induced vibratory loadings. Details of the calculation program may be found in SSC-229, Evaluation and Verification of Computer Calculations of Wave-Induced Ship Structural Loads, and in SSC-230, Program SCORES--Ship Structural Response in Waves.

Comments on this report would be welcomed.

Sincerely,



W. F. REA, III
Rear Admiral, U. S. Coast Guard
Chairman, Ship Structure Committee

SSC-231

Final Report

on

Project SR-174, "Ship Computer Response"

to the

Ship Structure Committee

FURTHER STUDIES OF COMPUTER SIMULATION
OF SLAMMING AND OTHER WAVE-INDUCED VIBRATORY
STRUCTURAL LOADINGS ON SHIPS IN WAVES

by

P. Kaplan and T. P. Sargent
Oceanics, Inc.

under

Department of the Navy
Naval Ship Engineering Center
Contract No. N00024-70-C-5076

*This document has been approved for public release and
sale; its distribution is unlimited.*

U. S. Coast Guard Headquarters
Washington, D. C.
1972

ABSTRACT

Results of analytical modeling and computer simulation of wave-induced structural loadings on ships in waves is presented, with consideration of bow flare slamming, bottom impact slamming, and springing. Consideration is given only to the case of head seas, and the outputs are obtained in the form of time histories due to the nature of the nonlinearities and the non-stationary properties associated with the slamming phenomena. Springing is considered to be linear and statistically stationary, and output in either time history or spectral form is possible, with the same r.m.s. value obtained by either technique. Time history simulation of the slowly-varying direct wave-induced vertical bending moment is also provided, so that relations between constituents making up the total vertical bending moment are demonstrated.

The output data is available at rates appreciably faster than real time (80 times or more faster) by use of a large commercial general purpose digital computer, thereby allowing rapid analysis of ship structural loads via computer simulation. The present results are primarily demonstrative of capability. Particular refinements in the manner of representing local forces, theoretical techniques for evaluation of such forces, and computational procedures, etc. that are necessary for producing a final completed program for calculation of such loads on a routine basis, are described in the report. The ultimate use of a developed program for vibratory loads, in conjunction with the previously established program for wave-induced bending moments, is a basic tool for application in design and analysis of ship structures.

CONTENTS

	<u>Page</u>
INTRODUCTION	1
MODAL METHOD OF ANALYSIS	3
APPLICATION TO BOW FLARE SLAMMING.	9
APPLICATION TO BOTTOM IMPACT SLAMMING.14
APPLICATION TO SPRINGING20
WAVE FORCE AT HIGH FREQUENCY26
DISCUSSION AND CONCLUDING REMARKS.32
REFERENCES35

NOMENCLATURE

a	=	wave amplitude
A	=	instantaneous submerged area of a ship section
A'_{33}	=	sectional vertical added mass
\bar{A}_{nl}	=	nonlinear sectional area difference
B^*	=	local waterline beam
c	=	structural damping coefficient; also wave celerity
C_i	=	weighted structural damping for i^{th} mode
C_s	=	local section area coefficient
EI	=	bending flexural rigidity
$F(\omega e)$	=	$\frac{2\pi}{\lambda}$, as a function of frequency of encounter for a given forward speed
\bar{h}	=	mean section draft
H	=	sectional draft
i	=	$\sqrt{-1}$, imaginary unit
$I_n(\)$	=	modified Bessel function
I_r	=	mass moment of inertia of a section
j	=	$\sqrt{-1}$, imaginary unit
k	=	$\frac{2\pi}{\lambda}$, wave number
K_i	=	weighted spring constant for i^{th} mode
K_M, K_θ	=	kernel functions for determining bending moment and pitch angle due to waves, respectively
L	=	ship length
$L_n(\)$	=	modified Struve function
\bar{m}	=	instantaneous added mass of ship section
\bar{m}_{nl}	=	nonlinear added mass difference
M	=	vertical bending moment
M_s	=	vertical bending moment due to slamming (or springing)
M_w	=	wave induced vertical bending moment
N'_z	=	sectional vertical damping force coefficient

$P(x,t)$	=	local input force
P_1, P_2	=	components of $P(x,t)$ due to added momentum and added buoyancy, respectively
$q_i(t)$	=	time-varying beam deflection for i^{th} mode
$Q_i(t)$	=	weighted forcing function for i^{th} mode
R	=	radius of circle
t	=	time
T	=	sampling time
$T_{\theta\eta}(\omega e)$	=	frequency response function of pitch with respect to wave
u	=	horizontal fluid velocity
v	=	vertical fluid velocity
V	=	ship forward speed
V_s	=	shear force
$w_c(x,t)$	=	vertical wave orbital velocity
w_r	=	relative vertical velocity
x	=	horizontal axis in direction of forward motion of ship (along length of ship)
$X_i(x)$	=	mode shape of i^{th} mode
Y	=	horizontal axis directed to starboard
z	=	heave motion, positive upwards
z_e	=	vertical elastic deflection
z_r	=	relative vertical immersion change
γ	=	elastic deformation angle
η	=	surface wave elevation, positive upwards
η_M	=	surface wave elevation encountered while moving forward
θ	=	pitch angle, positive bow up
λ	=	wavelength

μ = sum of sectional ship mass and added mass
 $\bar{\mu}_i$ = weighted total mass for i^{th} mode
 ϕ = velocity potential
 ϕ_w = velocity potential of surface waves
 ϕ_θ = pitch phase angle
 ω = circular frequency of waves (rad./sec.)
 ω_e = circular frequency of encounter (rad./sec.)

SHIP STRUCTURE COMMITTEE

The SHIP STRUCTURE COMMITTEE is constituted to prosecute a research program to improve the hull structures of ships by an extension of knowledge pertaining to design, materials and methods of fabrication.

RADM W. F. Rea, III, USCG, Chairman
Chief, Office of Merchant Marine Safety
U. S. Coast Guard Headquarters

Capt. J. E. Rasmussen, USN
Head, Ship Systems Engineering
and Design Department
Naval Ship Engineering Center
Naval Ship Systems Command

Mr. E. S. Dillon
Chief
Office of Ship Construction
Maritime Administration

Mr. K. Morland, Vice President
American Bureau of Shipping

Capt. L. L. Jackson, USN
Maintenance and Repair Officer
Military Sealift Command

SHIP STRUCTURE SUBCOMMITTEE

The SHIP STRUCTURE SUBCOMMITTEE acts for the Ship Structure Committee on technical matters by providing technical coordination for the determination of goals and objectives of the program, and by evaluating and interpreting the results in terms of ship structural design, construction and operation.

NAVAL SHIP ENGINEERING CENTER

Mr. P. M. Palermo - Chairman
Mr. J. B. O'Brien - Contract Administrator
Mr. G. Sorkin - Member
Mr. H. S. Sayre - Alternate
Mr. I. Fioriti - Alternate

OFFICE OF NAVAL RESEARCH

Mr. J. M. Crowley - Member
Dr. W. G. Rauch - Alternate

U. S. COAST GUARD

LCDR C. S. Loosmore, USCG - Secretary
CAPT C. R. Thompson, USCG - Member
CDR J. W. Kime, USCG - Alternate
CDR J. L. Coburn, USCG - Alternate

NAVAL SHIP RESEARCH & DEVELOPMENT CENTER

Mr. A. B. Stavovy - Alternate

MARITIME ADMINISTRATION

Mr. F. Dashnaw - Member
Mr. A. Maillar - Member
Mr. R. Falls - Alternate
Mr. R. F. Coombs - Alternate

NATIONAL ACADEMY OF SCIENCES - Ship Research Committee

Mr. R. W. Rumke, Liaison
Prof. R. A. Yagle, Liaison

MILITARY SEALIFT COMMAND

Mr. R. R. Askren - Member
LTJG E. T. Powers, USNR - Member

SOCIETY OF NAVAL ARCHITECTS & MARINE ENGINEERS

Mr. T. M. Buermann, Liaison

AMERICAN BUREAU OF SHIPPING

Mr. S. G. Stiansen - Member
Mr. F. J. Crum - Member

BRITISH NAVY STAFF

Dr. V. Flint, Liaison
CDR P. H. H. Ablett, RCNC, Liaison

WELDING RESEARCH COUNCIL

Mr. K. H. Koopman, Liaison
Mr. C. Larson, Liaison

INTRODUCTION

When considering the structural loads and responses acting on a ship in a seaway, the different effects contributing to the midship vertical bending moment (which is the major hull girder structural load) must be recognized and treated separately in any analysis and/or design study. In the case of the vertical bending moment on a ship in waves, the total load is made up of two distinct contributions, viz. the slowly-varying bending moment directly induced by the waves, and also a higher frequency response that exhibits the vibratory characteristics associated with the structural modes of the ship. The slowly-varying bending moment has a frequency domain bandwidth that lies within that associated with the waves (i.e. as encountered by the ship in its forward motion at speed), while the vibratory response is of a much higher frequency that is most often associated with the first structural bending mode (2-noded vibration) or perhaps some of the higher modes (see [1]).

Methods of computing the wave-induced bending moments, both vertical and lateral, as well as the wave-induced torsional moment, have been developed within the course of a project sponsored by the Ship Structure Committee (Project SR-174, "Ship Computer Response"), and the description of the analytical methods, calculation results, comparison with model experiments, and the developed digital computer programs are provided in [2] and [3]. These responses have been found to be linear in regard to their variation with wave amplitude; they are continuously varying just as the waves vary continuously; their statistical properties are determined via spectral analysis techniques, with these properties being statistically stationary in the same manner as the waves; and their evaluation requires determining the rigid body responses of the ship hull together with the contribution of these rigid body motions to the local forces that are distributed along the ship hull (outer envelope within the water as well as the internal ship mass distribution). The developments in [2] and [3] provide a useful tool for valid estimation of bending moment responses directly induced by the waves, with the output in terms of statistical averages appropriate to the particular wave spectrum in which the ship under consideration is assumed to operate.

The vibratory structural responses, as reflected in the vertical bending moment, are caused by entirely different mechanisms, and the properties of such responses also differ from those of the slowly varying wave-induced bending moments. These responses are often associated with the occurrence of large ship motions where emersion of the bow region can occur, leading to impact forces associated with entering the water (i.e. the ordinary case of ship slamming phenomena) or in the case of other ships with large bow flare present that leads to "whipping" resulting from the forces developed due to the bow flare shape variations (e.g. see [1]). The force mechanisms associated with the ship motions that produce the resulting input excitation are thus dependent on nonlinear effects,

although the rigid body motions of the ship per se are sufficiently well represented as linear responses, and these forces are known to be impulsive in nature. The resulting structural response, due to the excitation of the basic structural modes of the ship, is then manifested as a series of non-continuous high frequency oscillations (i.e. in the vertical bending moment) that only occur following the development of the impulsive local forces at the bow, i.e. a nonstationary record. The frequency of these vibratory responses is usually that of the first structural mode, i.e. the two-noded vibratory mode (see [1]), and the oscillations decay as a result of the combined influence of both structural and hydrodynamic damping. Thus it is easily seen how these structural responses due to slamming phenomena differ substantially from those bending moments that are the direct wave-induced structural reactions.

In addition to the vibratory bending responses that arise from slamming effects (both bow-flare as well as bottom impact slamming), another source of such responses occurs when the ship has small (or insignificant) motions in relatively short waves such that the frequency of encounter with the waves is close to that of the lower structural modes of vibration of the ship. This particular phenomenon has been denoted as "springing", with recent analytical efforts aimed at studying this effect given in [4] and [5]. The particular ships for which springing has an important influence are large tankers and bulk carriers (such as illustrated in [6]), as well as for fast ships such as destroyers and container ships. According to the results in [4] and [5], as well as the physical interpretation of the influence of short waves, i.e. it is a direct wave-excited vibration that is dominated by the two-node vibratory bending response of the ship structure. The application of spectral analysis techniques to this linear response, as shown in [4] and [5], provides statistical measures of the bending moment due to springing. These values can then be compared to the values due to the direct wave-induced bending moments experienced under the same and/or other particular wave spectral conditions in order to assess magnitudes that would be useful for design purposes.

It must be recognized however, that the springing phenomenon involves consideration of short waves relative to the ship length, and that the theoretical bases for evaluating the wave excitation forces acting on a ship were originally derived for conditions where the wavelengths were long compared to the dimensions of the ship cross-section (i.e. beam and/or draft). As a result there remains some question as to the full validity of any results obtained from such analyses, at least until some further consideration has been given to a more precise analysis of the forces acting on a ship hull due to short waves.

In order to obtain information on the vibratory structural loadings associated with the various phenomena described above, the techniques of computer simulation can be extended to these cases, based upon some of the developments described previously in [1]. In view of the fact that the slamming and bow flare effects require nonlinear force determination, as well as the fact that the resulting bending moment variations are also nonstationary, a

time domain treatment is suggested (see [1] and [7]). Similar treatment in regard to a time domain output representation can also be applied to the case of springing, although it is possible to obtain data from the use of frequency response and spectral analysis methods for that particular effect. However the form of time domain outputs, comparing the slowly-varying wave-induced vertical bending moment with the vibratory bending moment, are always useful illustrations that can provide certain additional insight. Another possible use of time domain outputs would be a more direct method of comparison with experimental results, since that would be a very definite method of validation of any analytical procedure, as long as the complete input information required for such a comparison is available.

Since the presence of time histories for slamming-related phenomena is the only possible way of providing a proper analysis of these effects, the ability to generate time histories with a computer at a relatively fast rate as compared to real time (i.e. the actual time for such occurrences as recorded on full scale ships) is another useful characteristic of computer simulation as compared to obtaining full scale data and/or carrying out model tests with proper structural simulation in the model. Thus the proper development of computer simulation for these vibratory structural loadings, which are assuming more importance as ships become larger and faster, will provide a useful tool in design, analysis, and evaluation studies associated with modern ship development.

The present report is intended to describe the results of computer simulation techniques for determining the various types of vibratory structural loads experienced by a ship at sea, as represented by the vertical bending moment. A number of particular computations will be illustrated and the nature of the results compared with that experienced in model tests and/or full scale tests, in accordance with the extent of available data for such purposes. An evaluation of the computational procedures, with regard to time and cost, will also be provided in order to illustrate the possible benefits that can be obtained via computer simulation. These results do not represent the final capability and results of computer simulation, but will only serve to illustrate the prospect of applying such techniques in a more comprehensive manner that includes a more complete mathematical representation and that would provide a final computer program output that could be applied toward the routine evaluation of these particular structural loadings, in the same manner as was provided in [2] and [3].

MODAL METHOD OF ANALYSIS

The vibratory structural loads are determined by considering the ship structure to be an elastic beam with nonuniform mass and elastic beam with its length. The equations representing this type of model have been presented previously in [1], and they are given below as:

$$\mu \frac{\partial^2 z}{\partial t^2} + c \frac{\partial z}{\partial t} + \frac{\partial V}{\partial x} = P(x,t) , \quad (1)$$

where $\mu = \mu(x)$ is the sum of the ship mass and the added mass at a section; z_e represents the vertical elastic deflection; c is the damping coefficient; V_s is the shear force; and $P(x,t)$ is the local input force due to ship-wave interaction.

$$\frac{\partial M}{\partial x} = V_s + I_r \frac{\partial^2 \gamma}{\partial t^2} \quad (2)$$

where M is the bending moment, I_r is the mass moment of inertia of a section, and γ is a deformation angle, with the last term on the right in Equation (2) representing the rotary inertia.

$$M = EI \frac{\partial \gamma}{\partial x} \quad (3)$$

is the fundamental elastic equation, with EI the bending flexural rigidity.

$$\frac{\partial z_e}{\partial x} = - \frac{V_s}{KAG} + \gamma \quad (4)$$

relates the bending and shear effects, where KAG is the vertical shear rigidity.

These partial differential equations were considered in [1], where different possible procedures for solution were examined for the case of an impulsive force localized in the bow region (the problem of bow-flare slamming). Since the output in time history form was desired, for a relatively higher frequency phenomenon relative to the direct wave system and its slowly-varying ship responses, the various methods of direct solution of the partial differential equations by conversion into ordinary differential-difference equations, breaking up the beam into a large number of nodal segments, etc. were found to be inapplicable to the simulation requirements. This was based upon limitations inherent in the computer components, problems of computational "stability" of the solutions, as well as the basic desire to obtain solutions at rates significantly faster than real-time (see [1] for a detailed discussion of these different aspects of computer simulation).

The method that was applied in [1] for treating the general problem of vibratory structural responses was to use a modal model to represent the basic ship beam structure, with neglect of rotary inertia (which should have a negligible effect for the present class of applications). The different variables in the equations are represented in product form as

$$z_e(x,t) = \sum_{i=1}^{\infty} q_i(t) X_i(x) \quad , \quad M(x,t) = \sum_{i=1}^{\infty} q_i(t) M_i(x)$$

$$V_s(x,t) = \sum_{i=1}^{\infty} q_i(t) V_{s_i}(x) \quad (5)$$

where $X_i(x)$ is the normal mode shape of the i^{th} mode. Using the results of a separation of variables method of solution for the unforced beam motion solution as a basis, the forced motion responses were found to be represented by

$$\bar{\mu}_i \ddot{q}_i + C_i \dot{q}_i + K_i q_i = Q_i(t) \quad (6)$$

where

$$\bar{\mu}_i = \int_{-L/2}^{L/2} \mu X_i^2(x) dx \quad , \quad (7)$$

$$C_i = \left(\frac{c}{\mu} \right) \bar{\mu}_i \quad , \quad (8)$$

since c/μ is assumed to be constant along the ship (at least for the structural damping contribution),

$$K_i = \omega_i^2 \bar{\mu}_i \quad , \quad (9)$$

with ω_i the natural frequency of the i^{th} mode (in rad./sec.), and

$$Q_i(t) = \int_{-L/2}^{L/2} P(x,t) X_i(x) dx \quad (10)$$

The representation of the bending moment spacial weighting is given by

$$M_i = \omega_i^2 \int_{-L/2}^x (x-s) \mu(s) X_i(s) ds \quad , \quad (11)$$

where the position x is the location at which the bending moment is desired, with $x=0$ the midship location taken as the coordinate origin and all integrations over the ship length extending from $x = -L/2$ (stern) to $x = L/2$ (bow). The expression in Equation (11) is based upon considering the main contribution to the bending moment to arise from the resulting inertial loads along the hull due to the vibratory deflections, including the fluid inertial force associated with the added mass.

The solution of Equation (6) is to be obtained for each mode, and then weighted in accordance with the particular mode shape or related spacial function, as indicated in Equation (5) where all responses are represented as the sum of the individual responses excited in the different modes of vibration. However in actual practice, for the ship responses considered herein, the first mode of vibration is most predominant with only a negligible contribution from the higher modes, thereby simplifying the computational requirements. In order to carry out the computer simulation by this method it is necessary to establish procedures for determining the natural frequencies and mode shapes (eigenvalues and eigenfunctions) associated with a ship structure, and also the technique for representing and/or determining the local input forces due to ship-wave interaction.

The determination of the natural frequencies and mode shapes of a ship structure, represented as a free-free beam, is carried out by adapting the available results of the U. S. Navy Generalized Bending Response Code (GBRCL), as described in [8]. When input data in the form of the distribution of inertial and structural properties (such as bending stiffness, shear stiffness, etc.) is given, a digital computer program based on Equations (1)-(4) will provide the desired output. The digital computer program described in [8] was obtained and converted for use on the CDC 6600 digital computer, and a check on the results was obtained by comparing the output for the first mode frequency and mode shape of the USS ESSEX with that given in [9], which was used in the work of [1]. Very good agreement was obtained in that case, and hence a useful tool for determining ship natural frequencies and mode shapes is thus available as one element for use in treating problems of ship structural response in waves.

The evaluation of the external forcing function is another problem, and that depends upon the basic cause of the particular type of vibratory loading under consideration. In the case of bow flare slamming treated in [1], the force considered as the input to excite vibratory response was due to nonlinear variations in buoyancy and inertial forces, over and above those used in the linear ship motion analysis. The instantaneous immersion and relative velocity of the various ship sections determines the buoyancy and fluid momentum values, using tabulated values of sectional area and added mass obtained from a previous off-line computation (see [1]). In the case of slamming that involves bottom impact when bow sections re-enter the water after emergence, the force computation also involves determination of nonlinear variations of added buoyancy and inertial contributions that are related to instantaneous values of section immersion and relative velocity, acceleration, etc. As a result, in both of these cases, it is necessary to obtain time history representations of the different linear ship motions necessary for evaluating the different force terms described above.

This is accomplished by means of a convolution integral operation in the time domain, where the encountered wave motion time history at a reference point relative to the ship is the input data that is operated upon with a weighting function kernel. The kernel function is obtained as the Fourier transform of the

frequency response function for the variable of interest, e.g. in the case of pitch motion the time history is given by

$$\theta(t) = \int_{-\infty}^{\infty} K_{\theta}(t-\tau) \eta_m(\tau) d\tau \quad (12)$$

where $\eta_m(t)$ is the encountered wave motion time history (present and past record),

$$K_{\theta}(t) = \frac{1}{2\pi} \int_{-\infty}^{\infty} T_{\theta\eta}(\omega_e; x_1) e^{i\omega_e t} d\omega_e \quad (13)$$

is the pitch kernel function, and the pitch frequency response to a unit sinusoidal wave (as measured at a point x_1 ahead of the origin of coordinates on the ship) is given by

$$T_{\theta\eta}(\omega_e; x_1) = \frac{|\theta|}{a} e^{i[\phi_{\theta} - F(\omega_e)x_1]} \quad (14)$$

in terms of amplitude (relative to wave amplitude a) and phase (ϕ_{θ} , relative to the coordinate origin, with the correction to x_1 in terms of $F(\omega_e) = \frac{2\pi}{\lambda}$ represented as a function of ω_e for a fixed forward speed). These procedures are described and illustrated in [1] for a particular ship case, and other illustrations of this method as well as extensions to determine further aspects of time domain computations are given in [10].

All of these operations are based on application of digital computers to carry out the evaluation of the frequency responses, kernel functions, etc., as well as the evaluation of the convolution integral operation on a wave motion time history input to produce output time histories of the desired motion, etc. The digital computer would then provide the necessary hydrodynamic force time history, serving as a function generator essentially, in a hybrid computer simulation procedure where the analog computer portion would provide the solution of the elastic response equation in modal form given by Equation (6). The required hybrid linkage elements such as A-D converters, D-A converters, etc., together with a noise generator and wave spectrum shaping filter, when added to the digital and analog computers described above, form the complete hybrid computer simulation system that was proposed and applied in [1] with good success.

Considering the greater generality and availability of large digital computers, as well as the fact that the slowly-varying wave-induced bending moments as well as frequency response functions of ship motions required for vibratory responses are found by use of large digital computers, the possibility of solving for the vibratory

structural responses in time history form on such computers would be a useful simplification of computational requirements. One possible approach would be to evaluate the closed form solution of Equation (6), which would be expressed as

$$q_i(t) = \int_0^t \frac{Q_i(\tau)}{\lambda_i \mu_i} e^{-\frac{c}{2\mu}(t-\tau)} \sin \lambda_i(t-\tau) d\tau \quad (15)$$

where

$$\lambda_i = \sqrt{\omega_i^2 - \frac{1}{4} \left(\frac{c}{\mu} \right)^2} \quad (16)$$

which is the solution for the initial conditions $q_i(0) = \dot{q}_i(0) = 0$. However a much simpler method of solution is available when recognizing that the differential equation in Equation (6) can be represented as a recursive digital filter, as illustrated in [11], where the term "recursive" implies that the computation of the output is an explicit function of previous outputs and inputs. The general second order difference equation for this system is

$$q(nT) = A_1 q(nT-T) + A_2 q(nT-2T) + G(nT) \quad (17)$$

where T is the sampling period and the coefficients A_1 and A_2 are related to the coefficients in Equation (6).

In order to check the capability of this digital model to represent the required solutions, the case with coefficients corresponding to the first mode of the USS ESSEX treated in [1] was established with an input function represented by the output of bandpass filtered white noise signal. A pulse was applied to this noise signal (which contained frequencies substantially lower than the representative second order dynamic system), and the response was obtained simultaneously from an analog computer and from a digital computer operating with the required A-D and D-A converters necessary for computing and display purposes. Representative output signals from both computers, as well as the input signal used, are shown in Figure 1 where it can be seen that the digital simulation is essentially the same as the results of analog simulation. This simple experiment was performed on a small digital computer (PDP-8) using a sampling rate of 12/sec., thereby indicating an expectation of excellent digital simulation by this technique when using a larger (and faster, more accurate, etc.) digital computer.

The application of the methods described in this section to the different types of vibratory structural responses of a ship in waves is presented in the following sections of this report. The particular force mechanism proposed, the method of time-domain

representation, and the results obtained are described separately for each type of response phenomenon. All necessary simulation techniques used are described together with information on the time requirements as compared to the extent of real time simulated.

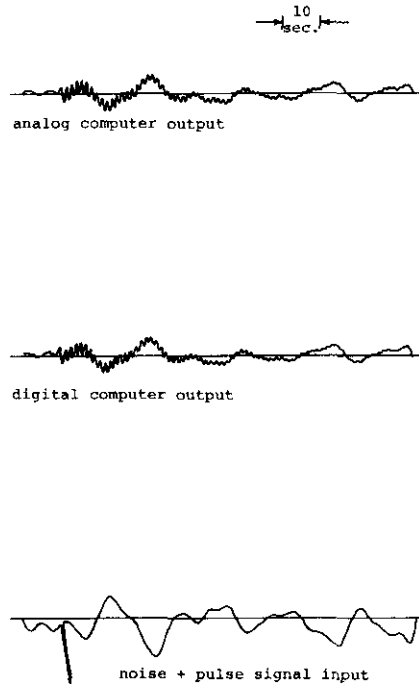

Fig. 1. Comparison of Output Signals from Analog and Digital Computer Simulations

APPLICATION TO BOW FLARE SLAMMING

The case of bow flare slamming has previously been treated in [1], and the present set of computer experiments is being carried out in order to judge the capabilities of a pure digital simulation of the bending moment due to the effects of large bow flare, where the treatment here is restricted to the case of head seas. The input force is made up of two terms, an inertial term represented by

$$P_1(x,t) = - \frac{D}{Dt} (\bar{m}_{nl} w_r) \quad (18)$$

where the operator

$$\frac{D}{Dt} = \frac{\partial}{\partial t} - V \frac{\partial}{\partial x} \quad ,$$

with V the ship forward speed, \bar{m}_{nl} is the additional added mass at a section that is determined from the instantaneous immersion

geometry of the ship section after subtracting out the added mass determined from the still water (linear theory) reference geometry, and w_r is the relative velocity at the section, given by

$$w_r = \dot{z} + x\dot{\theta} - V\theta - w_o(x,t) \quad (19)$$

The rigid body motions z and θ (and their derivatives) are determined from linear theory solutions (see [2]), and $w_o(x,t)$ is the wave orbital velocity given by

$$w_o(x,t) = \frac{D\eta}{Dt} = -\frac{2\pi ac}{\lambda} \cos \frac{2\pi}{\lambda} [x + (V+c)t] \quad (20)$$

for the present head sea case (illustrated here for sinusoidal waves), where c is the wave propagation speed. The force due to buoyancy, denoted as $P_2(x,t)$, is represented by

$$P_2(x,t) = \rho g \bar{A}_{n\ell}(z_r; x) \quad (21)$$

where $\bar{A}_{n\ell}$ is the additional cross-sectional area at a section due to the difference between the area corresponding to the instantaneous submerged portion of the ship section and that corresponding to the still waterline, after eliminating the linear buoyancy force terms. The quantity $\bar{A}_{n\ell}$ is determined, for a particular ship section, as a function of the relative immersion change

$$z_r = z + x\theta - \eta(x,t) \quad (22)$$

and it is expressed as

$$\bar{A}_{n\ell} = A - A_o + B^*z_r \quad (23)$$

where A is the instantaneous submerged area of a section, A_o is the area up to the still waterline, and B^*z_r corresponds to the linear spring rate that is included in the determination of the direct wave-induced rigid body motions and the wave-induced vertical bending moment (B^* is local beam).

The nonlinear buoyancy force defined in Equations (21)-(23) is determined in tabular form at various stations from the ship lines drawing, and the values of the added mass for different ship sections are calculated for the different levels of immersion. The added mass used in this investigation is the high frequency limit appropriate to vibratory response, and it is independent of gravity wave effects and is hence frequency-independent. A generalized program for computing the two-dimensional added mass of arbitrary ship sections has been developed and described in [1].

The computations illustrating bow flare slamming are made for the USS ESSEX, using the previously determined frequency response characteristics and resulting kernel functions for relative immersion and relative immersion velocity obtained in the work of [1]. These quantities were determined for a 13.8 knot forward speed and the reference position at which the waves were measured (the location of x_1) was taken at 30 ft. ahead of the ship FP. This location was sufficiently far forward so that the kernel functions had no significant magnitude for negative values of their argument, which is necessary for producing a kernel function that would allow evaluation of instantaneous conditions without any time lags, i.e. the operation takes place only on present and past values of the wave motion time history. Illustrations of the frequency responses and time domain kernel functions for this case are given in [1], where a time domain representation is also available in the form of a convolution integral for the slowly-varying bending moment directly induced by the waves. This quantity is represented by

$$M_W(t) = \int_{-\infty}^{\infty} K_M(t) \eta_m(t-\tau) d\tau \quad (24)$$

where $K_M(t)$ is found as the Fourier transform of the bending moment frequency response (i.e. amplitude and phase).

The wave record that is used in the digital simulation is obtained by initially constructing a digital filter that would produce a fit to the form of power spectral density functions that represent the wave spectrum as encountered by the ship when moving forward at speed, i.e. a spectrum in terms of the frequency of encounter ω_e . A sequence of random numbers that represent the equivalent of white noise is passed through this filter to produce the desired representation of the wave spectrum, in accordance with the procedures described in [12] to produce pseudo-random sequences with limited bandwidth that represents a simulation of the wave random process. This method of fit to the wave spectrum matches the general form, the location of the frequency of maximum spectral power, and the rms value (or significant height) of the resulting time history.

The nonlinear hydrodynamic forces were determined and applied at four points of the twenty beam segments making up the USS ESSEX. They were applied at the midpoints of each of the first four segments (stations $19\frac{1}{2}$, $18\frac{1}{2}$, $17\frac{1}{2}$ and $16\frac{1}{2}$) with the appropriate weighting in terms of the mode shape according to Equation (10). Computer runs were made to simulate the bending moment responses using a CDC 6600 digital computer, where the runs were made for a very severe sea state, viz. Sea State 9 which corresponded to a wind speed of 50 knots. Separate outputs were obtained on the computer for the midship bending moments due to waves and due to bow flare slamming (for the bending moment at midship). The output for the bow flare slam-induced bending moment was taken to be that due to the first mode response only, and all other higher modes were neglected in accordance with previous results indicating validity of this procedure in [1].

The output in the form of time histories of the wave-induced midship bending moment and the total bending moment (sum of wave-induced and bow flare slam-induced bending moments) is shown in Figure 2 together with the wave record corresponding to this Sea State 9. A relatively short time interval of only 17 seconds is illustrated in Figure 2 since the computations were carried out in order to correspond to every 0.5 seconds of real time, and extensive plotting is required for a relatively short time extent. However, the figure amply illustrates the presence of the large slamming effect evidenced by the bending moment response due to the "whipping" associated with the large bow flare slamming. While this is a very severe case, the capability of representing this response with a digital computer is amply illustrated by these results. The magnitude of the maximum total bending moment double amplitude at midship, corresponding to the 78 ft. significant height of the waves, was found to be 5×10^6 ft.-tons, which is larger in this case than the values obtained in the earlier work in [1]. This was due to a more precise inclusion of the effects of the spacial derivative term in the inertial force defined in Equation (18), i.e. the term corresponding to $V \frac{\partial \delta}{\partial x}$, which produces results that are closer to available model test data for this condition. The good agreement in overall characteristics of response, as well as the magnitude obtained in [1] and the present simulation results as compared to model test data, shows that the simulation provides generally good prediction of expected structural responses of ships in waves when experiencing bow flare slamming.

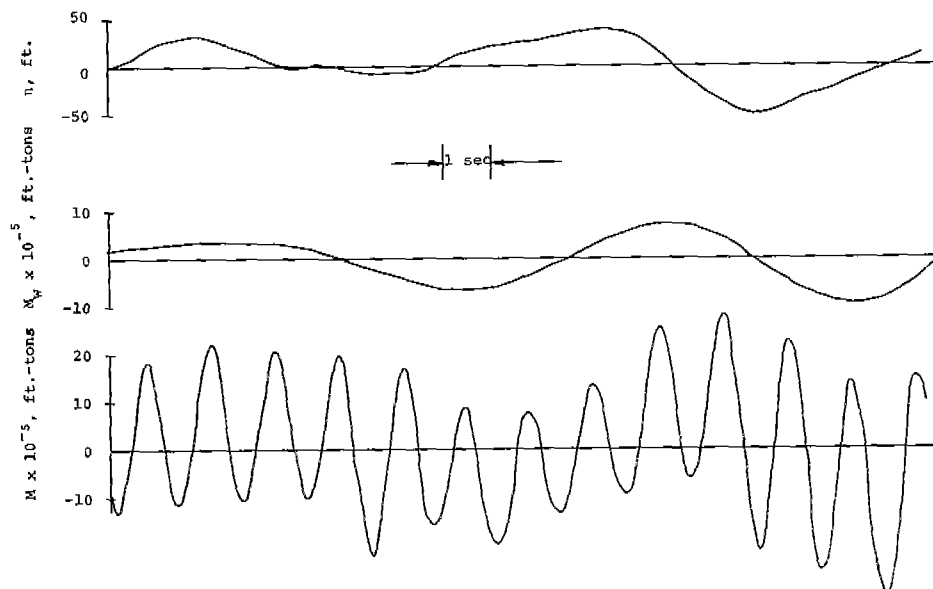

Fig. 2. Midship Bending Moment Time Histories, USS ESSEX,
 $V = 13.8$.kts., Sea State 9

In carrying out the various computational steps required to evaluate the bending moment time histories for particular sample sea states, some of the associated computations can be considered separately from the actual evaluation of the total bending moment (sum of wave-induced and bow flare slam-induced effects) per se. Thus

the computation of the structural mode shape and frequency, the kernel functions for relative immersion and velocity, the determination of the tabulated values of buoyancy and added mass, the wave spectrum filter, etc. can be carried out just once for any particular ship at a given forward speed since these quantities are then universal for those particular conditions. Once they are established, the actual time history of bending moments is then determined by the procedures discussed previously in this report. With the frequency response characteristics already determined by means of the digital computer procedure described in [2] and [3], all of the basic computed data and functions listed above can be obtained in a time period of approximately 30 seconds on the CDC 6600 computer. The computation time required for determining the total midship vertical bending moment, which is the sum of the wave-induced and bow flare slam-induced bending moments, is reduced significantly such that the computation proceeds at a rate equivalent to 170 times faster than real time (based on evaluation corresponding to every 0.05 sec. of real time). This is a significant increase in computer simulation capability such that rapid assessment of bending moment characteristics, including this type of slamming phenomenon, can be obtained simply and rapidly (hence at small cost). Thus a useful tool for design and analysis of ship structural response is available via computer simulation for this case, as compared to model testing and/or full scale tests. A flow chart illustrating the various procedures used in computing time histories of bending moments due to wave action and due to slamming is shown in Figure 3.

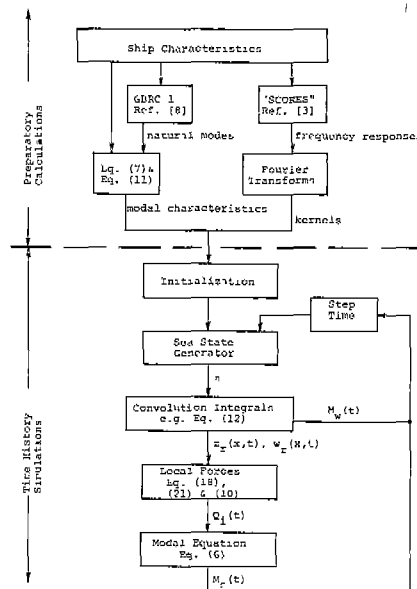

Fig. 3. Flow Chart for the Calculation of Slamming and Wave Bending Moment Time Histories

APPLICATION TO BOTTOM IMPACT SLAMMING

The usual condition known as slamming for ships in a seaway is associated with the emersion of the bow region from the water and its subsequent immersion upon re-entering the water, with an associated impact force acting on the ship during the initial phase of its re-entry. Most studies of slamming phenomenon have been primarily concerned with the aspects of the localized pressure pulses acting on portions of the bow (e.g. [13]), which would be responsible for local damage. However, the concern in the present investigation is the resulting vertical bending moment associated with the structural response of the ship, as measured for reference purposes at midships. The basic method of analysis will be the modal technique described previously in this report, with the main distinction for this particular application being the method of representation and computation of the exciting forces $P(x,t)$ due to ship-wave interaction.

The occurrence of slamming is associated with the bow region leaving the water and then re-entering at a sufficiently high velocity, which would produce a high frequency local acceleration at the bow as well as local pressure fluctuations and resulting whipping variations superimposed on the slowly-varying direct wave-induced bending moment. The time extent of the impact is relatively short, and particular full scale data such as that in [14] for the SS WOLVERINE STATE (a ship previously treated in [1], [2], and [7] for wave-induced bending moments) indicates a time duration extending up to the order of 0.25 sec. The basic mechanism for creating the impact force in the bow region is then associated with the rapid variation of effects that would contribute a local vertical force variation during re-entry and that may be ascribed to both an added buoyancy as well as an inertial force. The local added buoyancy force can be represented as

$$P_2(x,t) = \rho g A(z_r; x) \quad (25)$$

at the local station of interest, where A is the cross-sectional area that varies in accordance with the penetration of the section into the water. The inertial force is represented by

$$P_1 = - \frac{D}{Dt} (\bar{m} w_r) \quad (26)$$

where \bar{m} is the instantaneous added mass at the section of interest as the ship penetrates the water surface, w_r is the relative velocity defined in Equation (19), and the operator $\frac{D}{Dt}$ is the same as that defined following Equation (18). The important point in treating this problem is to recognize that the force only occurs when the ship section is penetrating the water surface after re-entering from above, with no force value acting prior to the instant of penetration. This reasoning is only applicable when considering the determination of forces associated with slamming per se, while an assumed linear force variation is considered to act on the ship in order to produce the actual rigid body motions, which in

themselves are found to be generally well represented by linear theory in spite of the fact that a portion of the ship may come out of the water.

Since the time interval for generating the impact force is relatively small in a real time sense, the time increment of solution must be reduced in order to adequately represent the phenomena that take place. However, this would tend to increase computation time and reduce the advantage of higher speed relative to real time occurrence, although the possible extent of reduction is not known until much more experience is obtained via a large degree of computer simulation experimentation. In order to carry out some of the initial experiments on bottom impact slamming a time increment (corresponding to a real time solution interval) of 0.25 sec. was chosen, and a method established for predicting the possible occurrence of a slam by means of extrapolating present position of a ship section above the instantaneous water surface until a re-entry was expected (using the value of the relative vertical velocity at the present instant of computed output). The variation of the local force components P_1 and P_2 , defined by Equations (25) and (26) was determined during the time interval between re-entry and the next time step in the computation, which would then be a total time interval of 0.25 sec. or less, with a check always being made as to whether the actual re-entry condition was achieved in order to include the proper force time history.

The inertial force component was determined, in regard to the operation $\frac{\partial}{\partial t}$, by determining incremental differences in the value of the product $\bar{m}w_r$ and dividing by the time interval. A more detailed determination of the force contribution due to the term $\frac{\partial}{\partial t}(\bar{m}w_r)$ could be obtained by means of the following:

$$\begin{aligned} \frac{\partial}{\partial t}(\bar{m}w_r) &= \bar{m} \frac{\partial w_r}{\partial t} + w_r \frac{\partial \bar{m}}{\partial z} \\ &= \bar{m} \frac{\partial w_r}{\partial t} + \frac{\partial \bar{m}}{\partial z} w_r^2 \end{aligned} \quad (27)$$

where an assumption of smaller time steps within the $\Delta t = 0.25$ sec. interval is assumed in order to allow for the more accurate value of $\frac{\partial \bar{m}}{\partial z}$ that is available from data that has already been tabulated (at 1 ft. intervals), while assuming a relatively constant value of w_r during these intervals and also taking the longer time step (i.e. 0.25 sec.) in the determination of $\frac{\partial w_r}{\partial t}$. However, much more extensive logic in the computer program $\frac{\partial w_r}{\partial t}$ is required in that case, and that approach was deferred to future investigations and computer experiments of greater extent than the present feasibility study.

The determination of time histories of the local forces is only carried out for one additional time step (0.25 sec.) beyond the interval during which the re-entry of the ship section occurs,

so that the total force input time history extent is at most 0.5 sec., which is considered to be sufficient to represent the impact time history associated with this type of slamming phenomenon. While this selection of time may be somewhat arbitrary, and raises the question of possibly too large a time extent of the impact force as well as associated errors in the resulting bending moment, a simple analysis illustrates the salient features of structural response that reduces the prospects of large errors due to this disturbance time extent selection.

The modal analysis method represents the input force in a weighted form given by the function $Q_i(t)$ defined by Equation (10) with $P(x,t) = P_1(x,t) + P_2(x,t)$. A closed form solution for the response $q_i(t)$ is given by Equation (15), which can be expanded into the form

$$q_i(t) = \frac{1}{\lambda_i \bar{\mu}_i} e^{-\frac{ct}{2\bar{\mu}}} \left[\sin \lambda_i t \int_0^t e^{\frac{c}{2\bar{\mu}} \tau} \cos \lambda_i \tau \cdot Q_i(\tau) d\tau \right. \\ \left. - \cos \lambda_i t \int_0^t e^{\frac{c}{2\bar{\mu}} \tau} \sin \lambda_i \tau \cdot Q_i(\tau) d\tau \right] \quad (28)$$

With $Q_i(\tau)$ only having a pulse-like value for a short period of time, say $t \leq 0.5$ sec., the integrals in Equation (28) extend only for $0 \rightarrow t$, and with small system damping the effect of the exponential is negligible. Thus the integral terms represent the effective Fourier components of the pulse-like force $Q_i(t)$ during the time extent t , with the Fourier components being those associated with the frequency ω_i (since $\lambda_i \approx \omega_i$ for small damping as shown in Equation (16)) and its higher harmonics (which would be negligible). Any contributions from a longer time extent for the $Q_i(t)$ function would be expected to reflect the influence of motions associated with the lower frequency wave-induced effects since the ship will have penetrated sufficiently far into the water that no significant changes in added mass and buoyancy would be occurring at a fast rate. The Fourier components at frequency ω_i would not be affected significantly by such force terms and hence no appreciable input to the final response will occur. The response of the system defined by Equation (28) is then a slowly decaying transient at the modal frequency ω_i , which is characteristic of the structural vibratory responses due to slamming, with the response mainly in the first mode, as mentioned previously.

Computations of the slamming responses were carried out for the SS WOLVERINE STATE in light load condition, as described in [2], when proceeding forward at a speed of 12 kts. in head seas represented by a Sea State 7 (34 kt. wind and 30 ft. significant height). The results of motion computations to produce frequency responses were obtained from [2], and this data was used to obtain the required kernel functions for use in convolution inte-

grals to obtain time histories of relative immersion, etc. The wave measurement reference point was located 35 ft. ahead of the ship FP, and the required information to determine the local forces was obtained for the first 4 stations of the ship in the bow region (stations 1-4), with the ship assumed to be divided into 20 stations. The first mode frequency was selected as $\omega_1 = 9.42$ rad./sec., corresponding to the full scale data reported in [14]. The mode shape was taken to be a simple parabolic curve that was similar to that previously computed for another Mariner-class ship, as given in [15]. The damping is made up of a structural damping term, as well as a term associated with the spacial variation of added mass, using the values of the added mass valid for high frequencies. This is based upon the negligible influence of damping due to wave generation at the structural mode frequencies, and the application of results of ship motion strip theory (see [2] and [4]). Values of structural damping are obtained from Fig. 2 of [4], so that the damping parameter C_1 in Equation (6) is defined by

$$C_1 = \left(\frac{c_s}{\mu} \right) \bar{\mu}_1^{-1/2} \int_{-L/2}^{L/2} \frac{dA'_{33}}{dx} X_1^2(x) dx \quad (29)$$

where A'_{33} is the local sectional vertical added mass (determined in this case for the high frequency limit). The value of total damping for the present case (first model response) was found to be $\frac{C_1}{\bar{\mu}_1} = 0.13$, with the structural damping portion corresponding to 0.055.

An analysis of the wave-induced midship bending moment for the WOLVERINE STATE in the frequency domain (by using the methods and results of [2]) yields the response amplitude operator (amplitude of bending moment per unit wave amplitude) given in Figure 4 for this case. The power spectrum of this bending moment resulting from assuming a wave spectrum corresponding to Sea State 7 is shown in Figure 5 (with total spectral area $= \sigma^2$, where σ is the rms value), with a resultant rms bending moment value of 3.55×10^4 ft.-tons. The amplitude response in Figure 4, together with phase information, was used to obtain the kernel function for the wave-induced bending moment. This allows generation of time domain records of this bending moment component for a given wave record input that could be compared with the slam-induced bending moment time histories via the computer simulation technique described above.

The results of the computations of slamming responses were obtained for an extensive run in time, where the occurrence of slamming was indicated directly in the computer output. As mentioned previously all computations were carried out during an equivalent time interval, corresponding to real time of 0.25 sec., while the solution of the modal responses from Equation (6) was carried out by means of the digital technique described by Equation (17) with a sampling time of every 0.05 sec. This was done

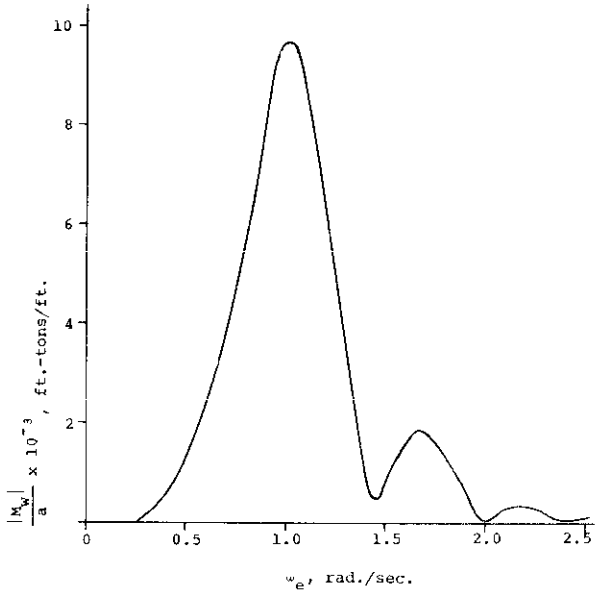

Fig. 4. Midship Wave-Induced Bending Moment Response Amplitude Operator, SS WOLVERINE STATE, V = 12 kts., Head Seas

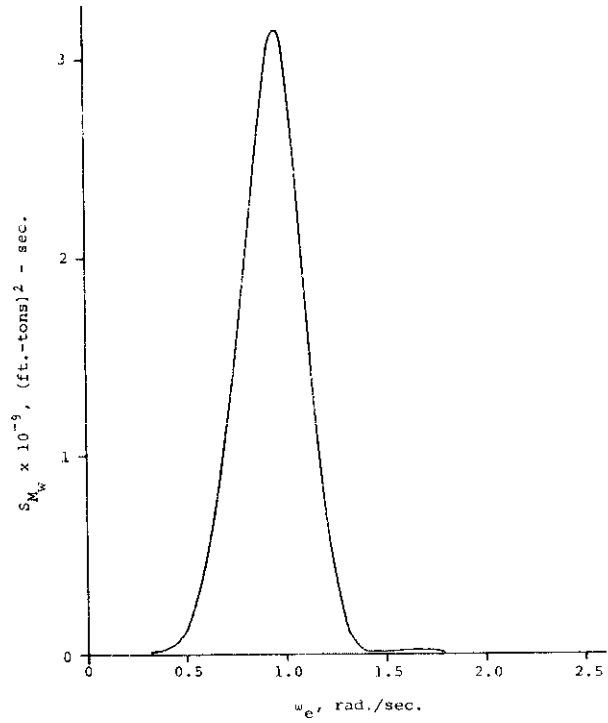

Fig. 5. Midship Wave-Induced Bending Moment Power Spectrum, SS WOLVERINE STATE, V = 12 kts., Sea State 7

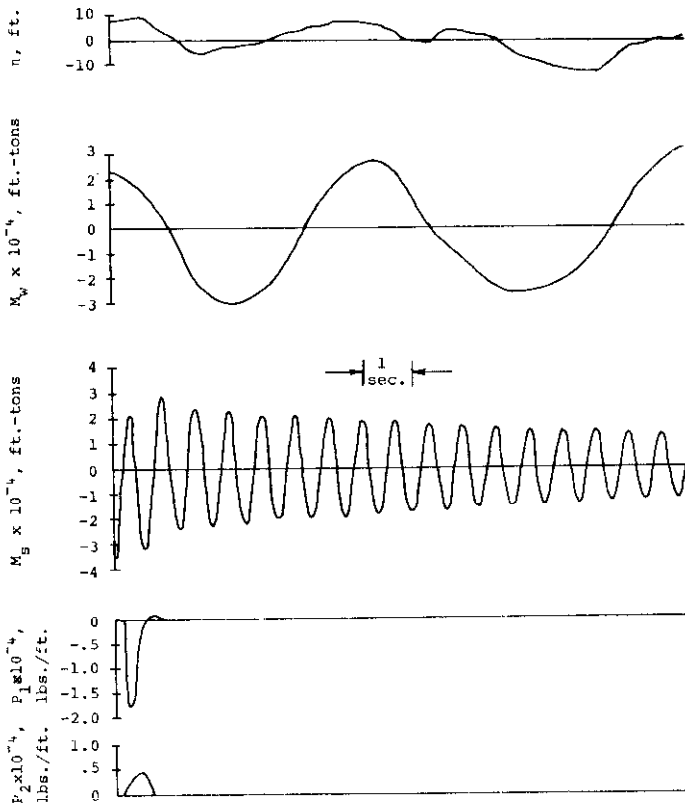

Fig. 6. Time Histories of Bending Moments and Associated Forces, WOLVERINE STATE, V = 12.0 kts., Sea State 7

in order to properly obtain the high frequency responses of the system, and it was also the basis for determining the responses due to bow-flare slamming treated in the previous section.

A typical output is shown in Figure 6, which provides a time history of the wave (as measured 35 ft. ahead of the ship), the wave induced bending moment, and the bending moment due to slamming. Since the system has relatively small damping the results of earlier slams are not sufficiently decayed, and there is often a mixture of contributions to the total slam output. The data in Figure 6 also shows the separate contributions of the two force terms at station 2 which contribute toward the slam response in this case. The results obtained for the bending moments associated with the bottom impact slam are much too large, since they are the same order of magnitude as the wave-induced bending moments and that is not the experience generally indicated in the results of [14]. However the relative vertical velocities in the bow region associated with the occurrence of slamming were found to be in the range of 12-20 ft./sec., which is in general agreement with such results in [14].

The large responses can be easily ascribed to the effect of too large an input force, mainly due to the inertial term P_1 given in Equation (26). This quantity is affected by the value of Δt chosen for the determination of the time derivative, and in addition the force magnitude is based upon the very simple model indicated by Equations (25) and (26). It is known that other effects are present which would account for the influence of the actual deadrise form of the section, which would also account for local water rise due to the impact, and might possibly require consideration of the effect of "cushioning" due to entrapped air, etc. All of these effects require a more sophisticated model for representing the forces, which goes beyond even the more accurate representation for the simplified inertial reaction shown in Equation (27). It does not appear to be difficult to carry out the determination of the bending moment response via the present methods as long as an accurate force input is included within the overall representation. The time scale for the present simulation was about 80 times faster than real time; which reflects the increased computation time required by reducing the time increment from 0.50 sec. to 0.25 sec. in this phase as compared to the case of bow-flare slamming treated earlier. Since the present program was a feasibility study for computer simulation, and complicated force mechanisms were not to be covered in detail, the basic capability of this simulation is indicated by the present results. However, more detailed analysis and representation of the local force variation, which can be obtained from many sources and which must then be converted into a useful computational form for evaluation of the forces within a small time increment, is the main task required for more precise slam-induced bending moment evaluations. This lies beyond the present investigation requirements and remains as a future task in continuation of ship structural response evaluation via computer simulation. However the basic computational procedures for evaluating the slam-induced bending moments are essentially the same as for the bow flare case, and are thus outlined in a flow chart form very similar to that in Figure 3.

APPLICATION TO SPRINGING

When considering the case of springing, the assumption is made that there is negligible influence of the ship rigid body motions on this particular phenomenon and that the external force acting on the vibratory system is only that due to the waves in their interaction with the ship. The local wave force acting on a section of the ship, which represents the force $P(x,t)$ in the model equation model, is given by

$$P(x,t) = \left[\rho g B^* \eta + \left(N'_z - V \frac{dA'_{33}}{dx} \right) \dot{\eta} + A'_{33} \ddot{\eta} \right] e^{-\frac{2\pi\bar{h}}{\lambda}} \quad (30)$$

where

$$\begin{aligned} \eta &= a \sin \frac{2\pi}{\lambda} \left[x + (V+c)t \right] \\ &= a \sin \left[\frac{2\pi x}{\lambda} + \omega_e t \right] \end{aligned} \quad (31)$$

is the surface wave elevation and

$$\begin{aligned} \dot{\eta} &= \frac{D\eta}{Dt} = \left(\frac{\partial}{\partial t} - V \frac{\partial}{\partial x} \right) \eta \\ \ddot{\eta} &= \frac{D\dot{\eta}}{Dt} = \left(\frac{\partial}{\partial t} - V \frac{\partial}{\partial x} \right) \dot{\eta} \end{aligned} \quad (32)$$

with

$$\omega_e = \frac{2\pi}{\lambda} (V+c) \quad (33)$$

The quantity N'_z is the local sectional vertical damping force coefficient, and \bar{h} is the mean section draft that is approximated by

$$\bar{h} = HC_s \quad (34)$$

where H is the local section draft and C_s is the local section area coefficient. This expression is obtained from [2] and represents the result of the usual technique of strip theory to express the vertical wave force acting on a ship.

In determining the quantity $Q_i(t)$ defined in Equation (10) it is necessary to weight the wave forces in terms of the mode shape and then integrate the result over the ship length. The computations must be carried out over a range of wave lengths that

would extend down to small values relative to the ship length in order to excite the higher frequencies that correspond to the ship structural modes, with the main influence being that of the first mode of vibration, as discussed previously. The particular requirements for carrying out such an integration in an accurate fashion by numerical means, as well as the results of application to a specific ship case, will be discussed in a later portion of this section of the report.

In order to obtain time histories for the case of springing, it would be necessary to obtain values of the wave time history and its next two time derivatives at various stations along the hull, with proper representation of the phase differences due to location. All of these terms must be related to the initial single wave motion time history as measured at a reference point ahead of the ship, and this would require at least one kernel function for each station (assuming 20 stations for the ship) as well as the requirements of a highly oscillatory kernel function for representing only a phase shift frequency response (see [16]). When coupled with the different spacial variations due to differing geometry at each of the stations along the ship, the computational complexity associated with this procedure is very evident. In order to proceed with a time domain representation of the springing response, it is then necessary to directly obtain frequency responses for the bending moment associated with the springing, which is obtained from the frequency response representation of the basic modal response, i.e. Equation (6). This will produce a resulting kernel function for the bending moment due to springing, which is expected to reflect the sharply tuned vibratory response associated with a lightly damped second order differential equation.

The solution for the vibratory response in the frequency domain is obtained by representing the forcing function $Q_i(t)$ in the form

$$Q_i(t) = Q_o e^{j\omega_e t} \quad (35)$$

so that the steady state solution of Equation (6) is given by

$$q_i = \frac{Q_o e^{j\omega_e t}}{K_i - \omega_e^2 \bar{\mu}_i + j\omega_e C_i} \quad (36)$$

in complex form, from which the amplitude and phase can be obtained as a function of the frequency ω_e . It can be easily shown that this solution leads to the same analytical result for the vertical elastic deflection as given in [4]. The midship bending moment is given by the present analysis as

$$M_s = -\omega_i^2 \int_{-L/2}^0 x \mu(x) X_i dx \cdot q_i(t) \quad (37)$$

where the significant response is given only for $i=1$, corresponding to the first mode of vibration of the ship structure, and this form can be expressed in terms of an amplitude and phase relative to a wave time history reference at a particular location with respect to the ship.

An application of this approach was made for a ship selected to represent a 200,000 dwt. tanker which was based on the Series 60, block coefficient 0.80, form that was previously analyzed for wave-induced bending moments in [2]. The ship had a displacement of 250,000 tons, with a length of 1,100 ft. and other geometric parameters corresponding to that particular Series 60 ship form. The first mode natural frequency was selected as $\omega_1 = 3.0$ rad./sec., and the mode shape was taken to correspond to the same basic parabolic form as used for the WOLVERINE STATE (obtained from [15]) but properly scaled to correspond to the dimensions of the ship selected. The forward speed was assumed to correspond to Froude No. = 0.15, which was a speed of 16.7 knots.

The wave force defined by Equation (30) was determined for a series of waves corresponding to the range $0.06 < \omega < 2.265$, thereby covering the normal rigid body ship response region as well as the range of short waves that would have encounter frequencies close to first vibration mode frequency. The computations of $P(x,t)$ were carried out by the use of the digital computer program in [3], using the complete frequency-dependent coefficient values determined from that program for each frequency (at higher frequencies the expected limits of the various coefficient terms such as N' and A'_{33} were properly obtained). The integration over the ship length, with the mode shape weighting $X_1(x)$, to produce the function $Q_1(t)$ defined in Equation (10) was carried out using Filon's method of integration [17] in order to properly account for the influence of the short waves relative to the station spacing corresponding to a 20 station representation.

The analysis described above for the case of springing is based on the modal response model, with the resulting bending moment due to springing represented by Equation (37). This result is obtained for the general case where it is assumed that responses are characterized directly in terms of a sum of separate results at each of the modal frequencies, as a result of transient impulsive inputs, and that form is also inherent in the results of the analysis in [5]. A simple examination of the consequence of the present analysis, as well as those exhibited in [5], shows a significant peak in the springing bending moment frequency response in the region where vertical ship motions are usually present. Since such motions have been neglected in the present case, there is a question as to the significance and validity of any large response indicated at those frequencies due to the springing phenomenon, which would not be expected to excite structural modes at the lower frequencies where wave-induced bending moments and ship motions are predominant.

An examination of the results for the problem of springing given in [4] shows a somewhat different behavior in the low frequency range, since the inertial reactions associated with the ship structural deflection accelerations introduce terms proportional to ω_e^2 which significantly reduce any possible contribution at the low frequencies (while still neglecting the ship rigid body motions).

While the influence of such an inertial reaction at frequencies higher than the first mode resonance would tend to amplify the bending moment response for this mode somewhat, the oscillatory decay at higher frequencies of the wave excitation forces $Q_1(t)$ in the deflection representation given by Equation (36) will reduce the springing bending moment response significantly in this higher frequency range. Thus the form of the frequency response for the midship bending moment due to springing should be more properly represented by

$$M_s = \int_{-L/2}^0 x \mu(x) X_1(x) dx \cdot \ddot{q}_1(t) \quad (38)$$

with a rapid asymptotic decay in frequency beyond the first mode value. The precise form of the wave excitation forces represented by $P(x,t)$ and the resulting $Q_1(t)$ is not known, although the value given by Equation (30) is used here and has also been applied in [4] and [5]. It is known that a rapid decay of these quantities with frequency will occur, so that the frequency response form beyond the first mode resonance will not be significantly altered. A more complete discussion and analysis of wave forces for short wavelengths relative to the ship length will be given in the next section of this report.

The frequency response functions were determined from Equations (36) and (38), where the damping value for this case corresponded to $\frac{C_1}{\mu_1} = 0.044$, with the amount 0.008 due to structural damping.

Figures 7 and 8 represent the midship bending moment frequency responses, from which a time domain kernel function corresponding to the wave reference point located 30 ft. ahead of the FP was calculated. This springing bending moment kernel function is shown in Figure 9, and the kernel function for the wave-induced midship bending moment is shown in Figure 10.

Computations of time history responses of these bending moments were carried out for this ship moving at 16.7 knots in a Sea State 5 which corresponds to a 22 kt. wind speed and a significant height of 10 ft. The filter representing the encountered wave motion spectrum was established by the approximation technique described in [12], which characterizes the major properties and form of the spectrum, although there may not be exact correspondence in the spectral ordinates at all frequencies, especially the higher values that would be of interest in the present problem. The wave spectral ordinate at the frequency $\omega_e = 3.0$ is 0.8 ft.²-sec. from the filter, while the theoretical value for an idealized wave spectrum is 0.5 ft.²-sec., so that a large springing response will be obtained here in the present simulation as compared to a value predicted for an idealized wave spectrum.

The computed time history responses of the wave induced bending moment and the springing bending moment are shown in Figure 11 together with the wave record corresponding to this Sea State 5. A time increment of .25 sec. (real-time) was chosen

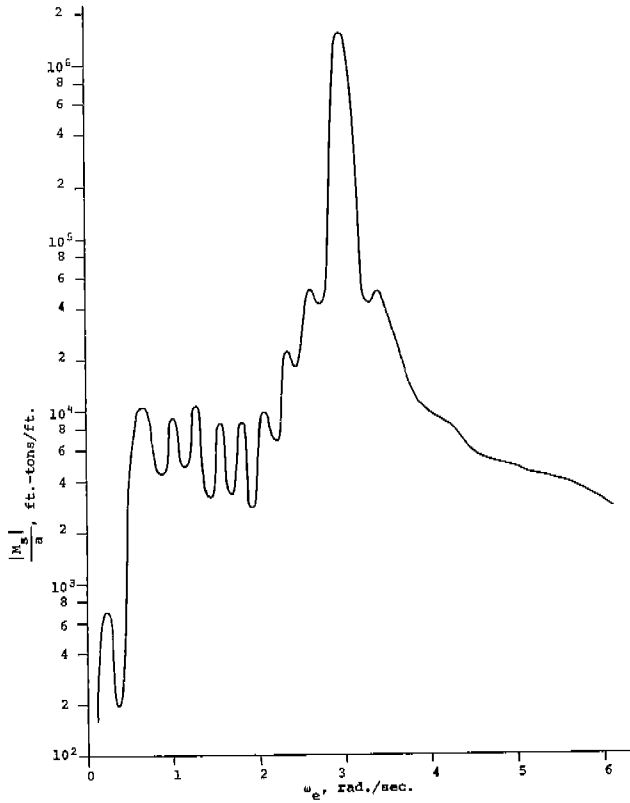

Fig. 7. Midship Springing Bending Moment Response Amplitude Operator, 200,000 dwt. Tanker, V = 16.7 kts.

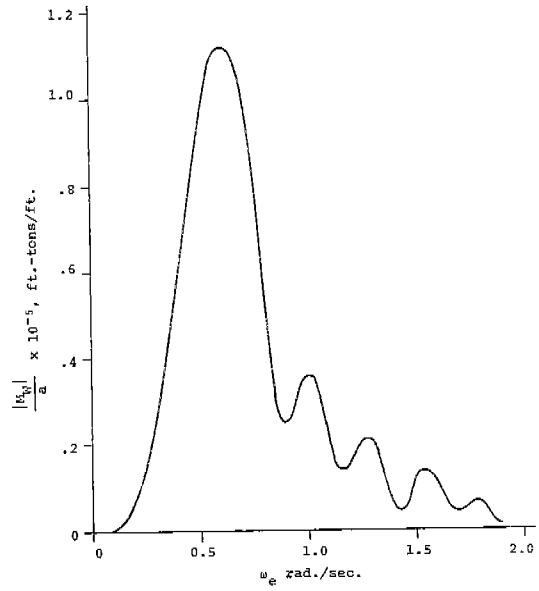

Fig. 8. Midship Wave-Induced Bending Moment Response Amplitude Operator, 200,000 dwt. Tanker, V = 16.7 kts.

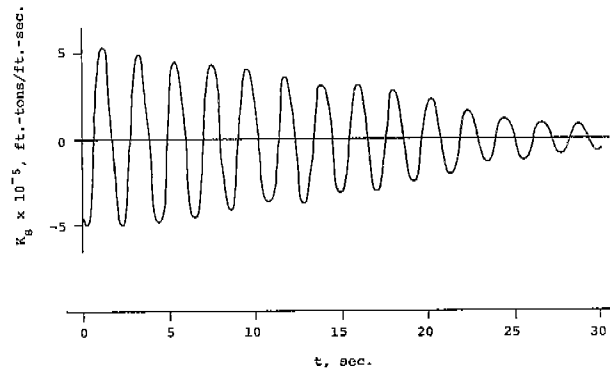

Fig. 9. Kernel Function for Midship Springing Bending Moment, 200,000 dwt. Tanker, V = 16.7 kts.

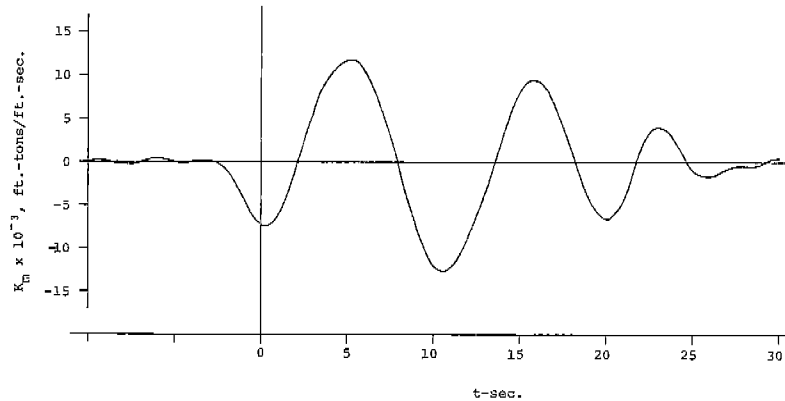

Fig. 10. Kernel Function for Wave-Induced Midship Bending Moments, 200,000 dwt. Tanker, $V = 16.7$ kts.

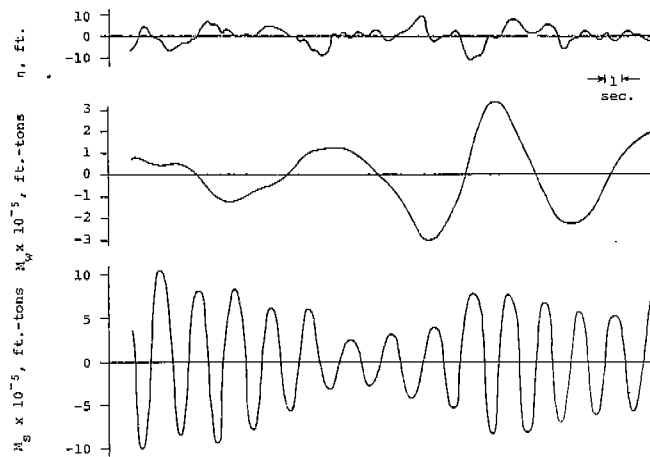

Fig. 11. Midship Bending Moment Time Histories, 200,000 dwt. Tanker, $V = 16.7$ kts.

for this phase of the study to properly handle the higher frequencies present in the springing phenomena. The time histories shown in Figure 11 clearly demonstrate the expected sharply tuned vibratory response associated with springing. The correctness of the magnitude of these moments can be ascertained by a comparison of the rms values obtained by an analysis of the time histories over a sufficiently long period of time with the rms values obtained from the areas under their respective power spectra. The power spectra used in this comparison is based on the wave generating digital filter rather than on an idealized wave spectra, since the purpose of the comparison is to validate the feasibility of using this technique of simulating the time history wave induced bending moment and springing bending moment experienced by ship in a random sea. The rms values of the wave-induced bending moment are 1.3×10^5 ft.-tons and 1.5×10^5 ft.-tons from the time history analysis and frequency domain analysis, respectively. The corresponding rms values for the springing bending moment are 4.4×10^5 ft.-tons and 4.1×10^5 ft.-tons. This close agreement demonstrates the feasibility of using the time domain representation of the springing response. The fact that the springing response has the

larger rms value is solely the result of the fall-off characteristics of the particular digital filter chosen for the study. A more exact digital filter representing the true wave spectra is easily obtainable if extreme resolution in duplicating frequency characteristics is required in this range.

Another feature of this time domain analysis is the fact that only two convolution integrals are required for the simulation. As a result, the computation of response time histories can be run 150 times faster than real time. The flow chart representing the computational procedures used in this time history simulation for bending moments due to springing and wave-induced (low frequency) effects is given in Figure 12.

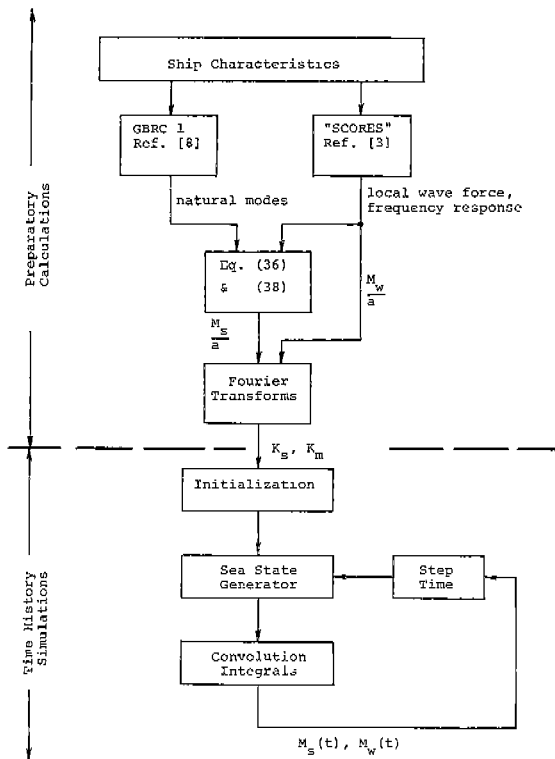

Fig. 12. Flow Chart for the Calculation of Springing and Wave Bending Moment Time Histories

WAVE FORCE AT HIGH FREQUENCY

As mentioned previously, as well as in the work of [4] and [5], the dependence of springing response on the wave force distribution along the ship hull in the high frequency range where this phenomenon occurs requires an examination of these forces in that range. The force expression used is valid for wavelengths that are of the order of the ship length ($kL=0(1)$), where $k = \frac{2\pi}{\lambda} = \frac{\omega^2}{g}$ and hence large compared to the cross sectional dimensions (see [18]) and [19]), while the important wavelengths

in the case of springing are of the order of the ship beam or draft.

In order to obtain further insight into the possible variation of the force at high frequencies, a limited analysis was carried out to derive the wave force under the initial assumption of high frequency. The analysis is restricted to the case of zero forward speed, for simplicity, and the assumption of treating a two-dimensional problem in the cross-flow plane for head seas is made. This latter assumption is based upon the form of the wave potential and associated interaction potential being proportional to e^{ikx} along the hull, which has already been shown to be applicable for submerged bodies in short waves ($kR=O(1)$, with R the radius). The problem is established in the two-dimensional cross-flow plane for a simple body, viz. a circle, as shown in the sketch below

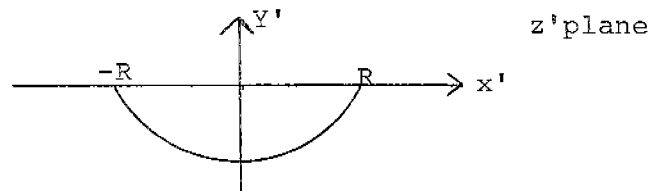

The incident wave potential is represented by

$$\phi_w = ace^{ky'} e^{i(kx - \omega t)} \quad (39)$$

where the x -coordinate is along the body length (to be distinguished from the x' -coordinate in the body sketch above). The two-dimensional Laplace equation is assumed to apply for the cross-flow potential ϕ , and this is solved by initially mapping the flow region into another plane, i.e. by use of the mapping transformation

$$\phi = 0; y' = 0, \text{ outside the body} \quad (40)$$

for the high frequency case. The vertical velocity on the circular boundary is known from the wave potential,

$$v = \frac{\partial \phi}{\partial y'} = akc e^{i(kx - \omega t)} e^{kR \sin \theta} \quad (41)$$

using the polar coordinate form in the z' -plane. Thus a mixed boundary value problem is established for the disturbance potential ϕ , and this is solved by initially mapping the flow region into another plane, i.e. by use of the mapping transformation

$$\zeta = \frac{1}{2} \left(z' + \frac{R^2}{z'} \right) \quad (42)$$

The velocities in the two planes are related by

$$-u'+iv' = (-u+iv) \left[1 \pm \frac{\zeta}{\sqrt{\zeta^2 - R^2}} \right] \quad (43)$$

where the primed (') quantities are those in the ζ -plane, and the resulting boundary value problem for the Laplace equation in this plane is shown in the sketch below

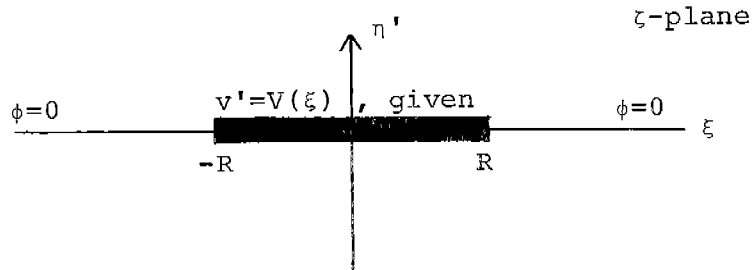

On the plate $\zeta = \xi$, where $|\xi| \leq R$, so that $v' = v$, which is expressed by

$$v' = akce^{i(kx - \omega t)} e^{-kR\sqrt{1 - (\xi/R)^2}} \quad (44)$$

The mixed boundary value problem can be converted into a singular integral equation by applying Green's theorem, leading to the Poisson formula for the half-plane, and that in turn by differentiation and integration operations with respect to the variables η' and ξ can be shown to lead to the equation

$$f(\xi) = d + \int_{-R}^{\xi} v'(s) dx = \frac{1}{\pi} \int_{-R}^R \frac{\phi(u)}{u - \xi} du \quad (45)$$

where d is a constant. The solution of this equation, assuming it is bounded at both ends ($-R$ and R), is given by

$$\phi(\xi) = -\frac{1}{\pi} \sqrt{R^2 - \xi^2} \int_{-R}^R \frac{f(u)}{\sqrt{R^2 - u^2} (u - \xi)} du \quad (46)$$

which is expressed by

$$\phi(\xi) = -\frac{1}{\pi} \sqrt{R^2 - \xi^2} \int_{-R}^R \frac{\int_{-R}^u v'(s) ds}{\sqrt{R^2 - u^2} (u - \xi)} du \quad (47)$$

since

$$d \int_{-R}^R \frac{du}{\sqrt{R^2-u^2} (u-\xi)} = 0 \quad (48)$$

(see [20] for discussion of solutions of singular integral equations).

The vertical force acting on the section is given by

$$F = -\rho R \int_{\pi}^{2\pi} \frac{\partial \phi_w}{\partial t} \sin \theta \, d\theta + \rho \int_{-R}^R \frac{\partial \phi}{\partial t} d\xi \quad (49)$$

where the part due to ϕ_w represents the direct incident wave force, which is primarily hydrostatic, while the part due to ϕ is the effect of wave-body interaction. Using the previous expressions and carrying out the indicated integration of the pressure represented by the operations in Equation (49), leads to

$$\begin{aligned} F_1 &= -\rho R \int_{\pi}^{2\pi} \frac{\partial \phi_w}{\partial t} \sin \theta \, d\theta \\ &= i\rho g a \operatorname{Re} e^{i(kx-\omega t)} \int_{\pi}^{2\pi} \sin \theta \, e^{kR \sin \theta} d\theta \end{aligned} \quad (50)$$

The integral can be expressed as

$$2 \int_0^{\pi/2} \cos \alpha \, e^{-kR \cos \alpha} \cos \alpha \, d\alpha \quad ,$$

which can be evaluated as

$$2 \int_0^{\pi/2} \cos \alpha \, e^{-kR \cos \alpha} \cos \alpha \, d\alpha = 2-\pi \left[I_1(kR) - L_1(kR) \right] \quad (51)$$

where I_1 and L_1 are a modified Bessel function and a modified Struve function, respectively ([21]).

The other force component, due to wave-body interaction, is given by

$$F_2 = \rho \int_{-R}^R \frac{\partial \Phi}{\partial t} d\xi \quad (52)$$

which can be reduced to a single integral expression given by

$$\begin{aligned} F_2 &= -i\rho g a k R^2 e^{i(kx - \omega t)} \int_{-\pi/2}^{\pi/2} \cos^2 \theta e^{-kR \cos \theta} d\theta \\ &= -i\rho g a k R^2 e^{i(kx - \omega t)} \left\{ I_0(kR) - L_0(kR) \right. \\ &\quad \left. - \frac{1}{kR} \left[I_1(kR) - L_1(kR) \right] \right\} \quad (53) \end{aligned}$$

The total wave force equal to the sum of F_1 and F_2 is then given by

$$F/\rho g a R = 2 - \pi (kR) \left[I_0(kR) - L_0(kR) \right] \quad (54)$$

which will be valid for high frequencies according to the previous derivation. Another approach was also used to treat this particular problem based on establishing an analysis that treats the high frequency problem by the method of matched asymptotic expansions [22], and the same exact result was obtained [23]. However the detailed consideration of the effects of high frequency led to an examination of the phenomena associated with the flow in the region of the "corners" representing the intersection at the ends of the section with the free surface. The corner problem must be solved, subject to a complicated differential equation that represents the flow conditions there, and that difficult problem must be treated in order to obtain a complete solution for the present case of high frequency waves. Since that is beyond the scope of the present investigation, no further consideration was given to that problem.

In order to compare the results of the present analysis, Equation (54), with the conventional value obtained from applying strip theory to this semicircle case, the results of Equation (30) were found for this configuration. The hydrostatic and added mass

terms are all that must be included for that case because of the high frequency limit, and they are given by

$$\begin{aligned}
 |P| &= 2 \rho g a R e^{-k\bar{h}} - \rho \frac{\pi R^2}{2} a k g e^{-k\bar{h}} \\
 &= \rho g a R e^{-k\bar{h}} \left[2 - \frac{\pi}{2} (kR) \right]
 \end{aligned} \tag{55}$$

where the average draft for the semicircle is

$$\bar{h} = \frac{\pi R^2/2}{2R} = \frac{\pi R}{4} \tag{56}$$

A comparison of the results of the force amplitude, in non-dimensional form $|F|$ or $|P|$, divided by $\rho g a R$, is given in Figure 13, over the range $3 < kR < 13$. This plot indicates that there is not much difference between the two results for this simple case, and hence any integration over a ship length, with variations of

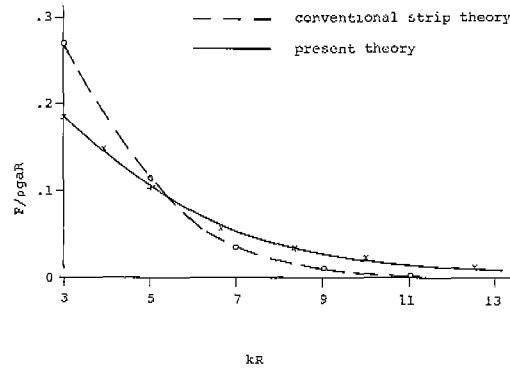

Fig. 13. Comparison of Theoretical Expressions for Sectional Wave Force on a Semicircle

section form and the associated effect of the sinusoidal functions of kx that are required, will not result in any significant force differences. The variation in force amplitude for different wavelengths will be mainly manifested by the influence of the e^{ikx} variation within the integrations, with only a small effect of the other weighting functions. This may possibly be altered as a result of including forward speed effects, which would involve more analytical complexity, or by the influence of the corner solution discussed previously. However no further consideration can be given to this problem at this time since it is beyond the scope of the present investigation, and it remains as a task for future detailed studies. At the present time though it appears that from the known available results, as shown above, that the strip theory values for wave force can still be used in the analysis of springing until such time as a more comprehensive theory (or results of experiments on high

frequency wave force measurements) shows significant differences from those values.

DISCUSSION AND CONCLUDING REMARKS

The results obtained in the preceding sections show that computer simulation techniques can be applied to determine the vibratory structural responses of ships in waves at a computational rate significantly faster than that required in the equivalent real time of the actual ship motion. The resulting time domain outputs can be displayed for detailed examination together with information on local force values, the time history of the reference waves that are basically responsible for bringing about the ship response, phase relations, etc. In addition the time domain outputs can be continuously processed on-line, i.e. simultaneously while they are being generated, in order to provide statistical measures such as rms values, peak values, level exceedance probability, and other desired properties of a time history record output just as is presently being done with full scale records from ships at sea (e.g. [14]), but with the added advantage of obtaining the results at a much faster rate than real-time. All of these results are obtained using a large high speed digital computer with programs written in the FORTRAN language. Thus a general utility can be achieved in determining this type of structural response by application of commercially available general purpose computers rather than being restricted to a particular special purpose computer or class of computers (such as hybrid systems, etc. that were initially applied in [1]).

The capability of achieving these results, with values that appear to be close to those obtained in experimental studies, is well demonstrated in the case of bow-flare slamming, where the physical model of the force mechanism is fairly well established and it is also a relatively continuous type of force variation. In the case of bottom impact slamming however, the force mechanism used herein was a simple model that also was limited in its simulation due to the time step restrictions imposed in the computations. A more realistic representation of the computations, such as that given in Equation (27), would appear to provide a better force expression that could reduce the influence of the increment of Δt used in the determination of time rate change. However even the basic force mechanism used here would not be expected to be fully appropriate, since a relatively flat bottom would produce very large changes in the time derivative $\frac{\partial \eta}{\partial t}$ that would not be realistic. Thus the task required in the case of simulating bottom impact slamming responses is a better representation of the local force associated with the entry of a ship section into the water. There are many possible models to use for this phenomenon, and they must be evaluated for their applicability since accurate representations of certain models of the flow field, such as the inclusion of entrapped air and its effect on the local water surface deformation, could not be reasonably expected to be proper (or even capable of adequate mathematical representation) when considering the real case of relative motion involving irregular wave forms, possible spray and local air content in the sea water, etc. While previous studies of impact on the water surface, when related to slamming,

have been mainly concerned with determining local pressure time histories at particular points (such as along the centerline, etc.) or some representation of spacial pressure distributions (with knowledge of their time history variations), the present problem requires determining the vertical force time history. The presence of the "smoothing" effect of spacial integration, which might be accomplished by analytic means initially, will tend to reduce the complexity of the computations as well as provide a more accurate total force representation.

The present computer experiments have demonstrated the feasibility of obtaining structural responses by the methods developed herein, and it then remains to apply more precise local force terms as an input. The most promising physical and mathematical models for such forces must be analyzed to determine their applicability to this present problem, which must include evaluating the computational efforts necessary for the force representation vis-a-vis the extent of final structural response output relative to experimental results, in order not to compromise any of the benefits possible in producing outputs at a rate significantly faster than real-time. This task is recommended as an important element to be accomplished in any further investigations of ship computer response studies.

For the case of springing, the only questionable aspect appears to be the accurate representation of the wave force along the hull for short wavelengths. The analytical studies described in the preceding section of this report did not seem to indicate any significant alteration in the force value relative to the value obtained by usual strip theory methods. However, the effect of forward speed should be examined, and similarly any possible influence of the "corner problem" described in the last section should also be studied, in order to cover the possible variations in the hydrodynamic wave force that would influence the magnitude of springing response. Incorporation of such results into the available mathematical and computational model can be easily accomplished, resulting in a useful tool for predicting the magnitude and properties of that type of structural response.

The form of representation of springing response can be given in terms of spectral output, in the frequency domain, or alternatively time histories can be provided. Since the fundamental phenomena are linear, the output in the form of spectra and associated statistical properties such as rms, significant amplitude, etc. are more easily determined in that manner. Time history outputs are also useful for correlation purposes, examining the decay properties of the vibrations, and other detailed studies of a representative record of response. Another useful application of time history outputs is for comparison with model experimental data, since magnitude and phase for regular waves (and precise time history duplication) can be easily compared to determine the validity of the theory in detail.

Some consideration should also be given to conducting verification model experiments for the vibratory structural responses, using a segmented model that contains sufficient flexibility to provide vibratory structural response data. The model should have all of its structural and inertial properties fully defined for

purposes of direct comparison to theoretical computed results. An interchangeable bow region can be built so that it can reflect the form, flare, bottom contour, etc. that would be appropriate to such ships as container vessels, normal cargo ships, tankers, etc. Thus different tests can be carried out in waves to represent the effect of slamming (bow flare and bottom impact) when the ship has large motions in the waves, as well as for springing by testing in short waves. Careful design of the model and test programs will allow covering these different and important structural response phenomena, and will provide a direct and useful validation of results obtained from computer simulation studies.

The various analytical and computational procedures described above can be readily accomplished, and represent a logical continuation of the efforts originally established for the ship computer response project. The final product will be a digital computer program, similar to that described in [2] and [3], that will enable users to obtain outputs for determining structural responses of vibratory nature such as those resulting from slamming and springing. Thus a complete evaluation of the major structural loads and responses of a ship in a seaway can then be predicted in a relatively short time by use of that type of program, in conjunction with that in [3], as an important tool in design and analysis studies. Depending upon the extent of validation desired, the experimental program described above can also be carried out as an adjunct to the computer program development in order to assess the reliability of the analytical/computational procedures in providing realistic values of ship structural loads.

REFERENCES

1. Kaplan, P., Sargent, T.P. and Raff, A.I.: "An Investigation of the Utility of Computer Simulation to Predict Ship Structural Response in Waves", Ship Structure Comm. Rpt. SSC-197, June 1969.
2. Kaplan, P., and Raff, A.I.: "Refinement and Evaluation of Computer Calculated Ship Structural Loads in Waves", Ship Structure Comm. Rpt. SSC-229, July 1972.
3. Raff, A.I. : "Program SCORES-Ship Structural Response in Waves", Ship Structure Comm. Rpt. SSC-230, July 1972.
4. Goodman, R.A. : "Wave Excited Main Hull Vibration in Large Tankers and Bulk Carriers", paper presented at meeting of RINA, April 1970.
5. van Gunsteren, F.F.: "Springing. Wave Induced Ship Vibrations", Int. Shipbuilding Prog., Vol. 17, No. 195, November 1970.
6. Mathews, S.T.: "Main Hull Girder Loads on a Great Lakes Bulk Carrier", paper presented at Spring Mtg. SNAME, Montreal, Canada, July 1967.
7. Kaplan, P.: "Development of Mathematical Models for Describing Ship Structural Response in Waves", Ship Structure Comm. Rpt. SSC-103, January 1969.
8. Cuthill, E.H. and Henderson, F.M. : "Description and Usage of General Bending Response Code 1 (GBRC1)", DTMB Report No. 1925, July 1965.
9. Andrews, J.N. and Chuang, S.L.: "Seaworthiness Analog Computer", DTMB Report No. 1829, August 1965.
10. Kaplan, P.: "A Study of Prediction Techniques for Aircraft Carrier Motions at Sea", Jour. of Hydronautics, Vol. 3, No. 3, July 1969.
11. Gold, B. and Rader, C.M.: Digital Processing of Signals, McGraw-Hill Book Co., 1969.
12. Stearns, S.D.: "Digital Simulation of Frequency-Limited Random Functions", Simulation, Vol. 12, No. 1, Jan. 1969.
13. Ochi, M.K. : "Extreme Behavior of a Ship in Rough Seas-Slamming and Shipping of Green Water", Trans. SNAME, 1964.
14. Wheaton, J.W., Kano, C.H., Diamant, P.T., and Bailey, F.C. : "Analysis of Slamming Data from the S.S. Wolverine State", Ship Structure Comm. Rpt. No. SSC-210, 1970

15. Leibowitz, R.C.: "Natural Modes and Frequencies of Vertical Vibration of a Beam with an Attached Sprung Mass", DTMB Rpt. No. 1215, September 1958.
16. Davis, M C., Lt. Cdr. USN and Zarnick, E.E. : "Testing Ship Models in Transient Waves", Proc. Fifth Symp. on Naval Hydrodynamics, Bergen, Norway, Sept. 1964.
17. Hamming, R.W.: Numerical Methods for Scientists and Engineers, McGraw Hill Book Co., 1962.
18. Korvin-Kroukovsky, B.V. and Jacobs, W.R. : "Pitching and Heaving Motions of a Ship in Regular Waves", Trans. SNAME, 1957.
19. Kaplan, P., and Hu, Pung Nien : "Virtual Mass and Slender Body Theory for Bodies in Waves", Proc. of the Sixth Midwest Conference on Fluid and Solid Mechanics, Univ. of Texas, Sept. 1959.
20. Muskhelishvili, N.I.: Singular Integral Equations, English TRANSLATION, Noordhoff, Groningen, 1963.
21. McLaughlin, N.W.: Bessel Functions for Engineers, Second Edition, Oxford University Press, 1961.
22. Van Dyke, M.: Perturbation Methods in Fluid Mechanics, Volume 8, Academic Press, 1964.
23. Goodman, T.R. : Results presented at H-5 Panel Meeting, SNAME, November 1970 (Informal).

DOCUMENT CONTROL DATA - R & D

(Security classification of title, body of abstract and indexing annotation must be entered when the overall report is classified)

1. ORIGINATING ACTIVITY (Corporate author) Oceanics, Inc. Plainview, New York		2a. REPORT SECURITY CLASSIFICATION Unclassified	
3. REPORT TITLE Further Studies of Computer Simulation of Slamming and Other Wave-Induced Vibratory Structural Loadings on Ships in Waves		2b. GROUP	
4. DESCRIPTIVE NOTES (Type of report and inclusive dates)			
5. AUTHOR(S) (First name, middle initial, last name) P. Kaplan and T. P. Sargent			
6. REPORT DATE July 1972	7a. TOTAL NO. OF PAGES 36	7b. NO. OF REFS 23	
8a. CONTRACT OR GRANT NO. N00024-70-C-5076	9a. ORIGINATOR'S REPORT NUMBER(S)		
b. PROJECT NO.	9b. OTHER REPORT NO(S) (Any other numbers that may be assigned this report)		
c.	SSC-231		
d.			
10. DISTRIBUTION STATEMENT Unlimited			
11. SUPPLEMENTARY NOTES		12. SPONSORING MILITARY ACTIVITY Naval Ship Systems Command	
13. ABSTRACT Results of analytical modeling and computer simulation of wave-induced structural loadings on ships in waves is presented, with consideration of bow flare slamming, bottom impact slamming, and springing. Consideration is given only to the case of head seas, and the outputs are obtained in the form of time histories due to the nature of the nonlinearities and the non-stationary properties associated with the slamming phenomena. Springing is considered to be linear and statistically stationary, and output in either time history or spectral form is possible, with the same r.m.s. value obtained by either technique. Time history simulation of the slowly-varying direct wave-induced vertical bending moment is also provided, so that relations between constituents making up the total vertical bending moment are demonstrated. The output data is available at rates appreciably faster than real time (80 times or more faster) by use of a large commercial general purpose digital computer, thereby allowing rapid analysis of ship structural loads via computer simulation. The present results are primarily demonstrative of capability. Particular refinements in the manner of representing local forces, theoretical techniques for evaluation of such forces, and computational procedures, etc. that are necessary for producing a final completed program for calculation of such loads on a routine basis, are described in the report.			

14 KEY WORDS	LINK A		LINK B		LINK C	
	ROLE	WT	ROLE	WT	ROLE	WT

SHIP RESEARCH COMMITTEE
Maritime Transportation Research Board
National Academy of Sciences-National Research Council

The Ship Research Committee has technical cognizance of the inter-agency Ship Structure Committee's research program:

PROF. R. A. YAGLE, Chairman, *Prof. of Naval Architecture, University of Michigan*
DR. H. N. ABRAMSON, *Director, Dept. of Mechanical Sciences, Southwest Research Inst.*
MR. W. H. BUCKLEY, *Coordinator of Hydrofoil Struc. Res., Naval Ship R & D Center*
MR. E. L. CRISCUOLO, *Senior Non-destructive Testing Spec., Naval Ordnance Lab.*
DR. W. D. DOTY, *Research Consultant, U. S. Steel Corporation*
PROF. J. E. GOLDBERG, *School of Civil Engineering, Purdue University*
PROF. W. J. HALL, *Prof. of Civil Engineering, University of Illinois*
MR. J. E. HERZ, *Chief Structural Design Engineer, Sun Shipbuilding & Dry Dock Co.*
MR. G. E. KAMPSCHAEFER, JR., *Manager, Application Engineering, ARMCO Steel Corporation*
MR. R. C. STRASSER, *Director of Research, Newport News Shipbuilding & Dry Dock Co.*
CAPT R. M. WHITE, USCG, *Chief, Applied Engineering Section, U. S. Coast Guard Academy*
MR. R. W. RUMKE, *Executive Secretary, Ship Research Committee*

Advisory Group I, "Ship Response and Load Criteria" prepared the project prospectus and evaluated the proposals for this project.

DR. H. N. ABRAMSON, Chairman, *Director, Dept. of Mech. Sciences, Southwest Res. Inst.*
MR. W. H. BUCKLEY, *Coordinator of Hydrofoil Struc. Res., Naval Ship R & D Center*
PROF. A. M. FREUDENTHAL, *College of Engineering, George Washington University*
MR. R. G. KLINE, *Associate Research Consultant, U. S. Steel Corporation*
DR. M. K. OCHI, *Research Scientist, Naval Ship R & D Center*
MR. R. C. STRASSER, *Director of Research, Newport News Shipbuilding & Dry Dock Co.*
CAPT R. M. WHITE, USCG, *Chief, Applied Engineering Section, U. S. Coast Guard Academy*

The SR-174 Project Advisory Committee provided the liaison technical guidance, and reviewed the project reports with the investigator.

DR. H. N. ABRAMSON, Chairman, *Director, Dept. of Mech. Sciences, Southwest Res. Inst.*
MR. M. K. OCHI, *Research Scientist, Naval Ship R & D Center*
MR. R. C. STRASSER, *Director of Research, Newport News Shipbuilding & Dry Dock Co.*

SHIP STRUCTURE COMMITTEE PUBLICATIONS

These documents are distributed by the National Technical Information Service, Springfield, Va. 22151. These documents have been announced in the Clearinghouse Journal U.S. Government Research & Development Reports (USGRDR) under the indicated AD numbers.

- SSC-219, *Crack Propagation and Arrest in Ship and Other Steels* by G. T. Hahn, R. G. Hoagland, P. N. Mincer, A. R. Rosenfield, and M. Sarrate. 1971.
- SSC-220, *A Limited Survey of Ship Structural Damage* by S. Hawkins, G. H. Levine, and R. Taggart. 1971.
- SSC-221, *Response of the Delta Test to Specimen Variables* by L. J. McGeady. 1971.
- SSC-222, *Catamarans - Technological Limits to Size and Appraisal of Structural Design Information and Procedures* by N. M. Maniar and W. P. Chiang. 1971.
- SSC-223, *Compressive Strength of Ship Hull Girders - Part II - Stiffened Plates* by H. Becker, A. Colao, R. Goldman, and J. Pozerycki. 1971.
- SSC-224, *Feasibility Study of Glass Reinforced Plastic Cargo Ship* by R. J. Scott and J. H. Sommella. 1971.
- SSC-225, *Structural Analysis of Longitudinally Framed Ships* by R. Nielson, P. Y. Chang, and L. C. Deschamps. 1972.
- SSC-226, *Tanker Longitudinal Strength Analysis - User's Manual and Computer Program* by R. Nielson, P. Y. Chang, and L. C. Deschamps. 1972.
- SSC-227, *Tanker Transverse Strength Analysis - User's Manual* by R. Nielson, P. Y. Chang, and L. C. Deschamps. 1972.
- SSC-228, *Tanker Transverse Strength Analysis - Programmer's Manual* by R. Nielson, P. Y. Chang, and L. C. Deschamps. 1972.
- SSC-229, *Evaluation and Verification of Computer Calculations of Wave-Induced Ship Structural Loads* by P. Kaplan and A. I. Raff. 1972.
- SSC-230, *Program SCORES -- Ship Structural Response in Waves* by A. I. Raff. 1972.
- SSC-231, *Further Studies of Computer Simulation of Slamming and Other Wave-Induced Vibratory Structural Loadings on Ships in Waves* by P. Kaplan and T. P. Sargent. 1972.