

TECHNICAL REPORT

ON

**THE FUNDAMENTAL FACTORS INFLUENCING THE BEHAVIOR
OF WELDED STRUCTURES UNDER CONDITIONS OF MULTIAXIAL
STRESS, AND VARIATIONS OF TEMPERATURE, STRESS
CONCENTRATION, AND RATES OF STRAIN**

BY

G. SACHS, L. J. EBERT and A. W. DANA

**Case Institute of Technology
Under Bureau of Ships Contract NObs-45470**

COMMITTEE ON SHIP CONSTRUCTION

DIVISION OF ENGINEERING AND INDUSTRIAL RESEARCH

NATIONAL RESEARCH COUNCIL

ADVISORY TO

SHIP STRUCTURE COMMITTEE

UNDER

**Bureau of Ships, Navy Department
Contract NObs-34231**

SERIAL NO. SSC-24

COPY NO. 26 .

DATE: MAY 10, 1949

NATIONAL RESEARCH COUNCIL
Washington 25, D. C.

May 10, 1949

Chief, Bureau of Ships
Navy Department
Washington 25, D. C.

Dear Sir:

Attached is Report Serial No. SSC-24 entitled "The Fundamental Factors Influencing the Behavior of Welded Structures under Conditions of Multiaxial Stress, and Variations of Temperature, Stress Concentration, and Rates of Strain." This report has been submitted by the contractor as a Technical Report of the work done on Research Project SR-99 under Contract NObs-45470 between the Bureau of Ships, Navy Department and Case Institute of Technology.

The report has been reviewed and acceptance recommended by representatives of the Committee on Ship Construction, Division of Engineering and Industrial Research, NRC, in accordance with the terms of the contract between the Bureau of Ships, Navy Department and the National Academy of Sciences.

Very truly yours,

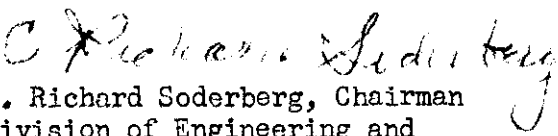
C. Richard Soderberg, Chairman
Division of Engineering and
Industrial Research

CRS:es
Enclosure

PREFACE

The Navy Department through the Bureau of Ships is distributing this report to those agencies and individuals who were actively associated with the research work. This report represents a part of the research work contracted for under the section of the Navy's directive "to investigate the design and construction of welded steel merchant vessels."

The distribution of this report is as follows:

Copy No. 1 - Chief, Bureau of Ships, Navy Department
Copy No. 2 - Dr. D. W. Bronk, Chairman, National Research Council

Committee on Ship Construction.

Copy No. 3 - V. H. Schnee, Chairman
Copy No. 4 - J. L. Bates
Copy No. 5 - H. C. Boardman
Copy No. 6 - Paul Ffield
Copy No. 7 - M. A. Grossman
Copy No. 8 - C. H. Herty, Jr.
Copy No. 9 - A. B. Kinzel
Copy No. 10 - J. M. Lessells
Copy No. 11 - G. S. Mikhalapov
Copy No. 12 - J. Ormondroyd
Copy No. 13 - H. W. Pierce
Copy No. 14 - E. C. Smith
Copy No. 15 - T. T. Watson
Copy No. 16 - Finn Jonassen, Research Coordinator

Members of Project Advisory Committees SR-25, SR-87,
SR-92, SR-96, SR-98, SR-99, SR-100 and SR-101

Copy No. 16 - Finn Jonassen, Chairman
Copy No. 17 - R. H. Aborn
Copy No. 18 - L. C. Bibber
Copy No. 5 - H. C. Boardman
Copy No. 19 - T. J. Dolan
Copy No. 6 - Paul Ffield
Copy No. 7 - M. A. Grossman
Copy No. 8 - C. H. Herty, Jr.
Copy No. 20 - C. E. Jackson
Copy No. 10 - J. M. Lessells
Copy No. 21 - M. W. Lightner
Copy No. 11 - G. S. Mikhalapov
Copy No. 12 - J. Ormondroyd
Copy No. 22 - R. E. Peterson
Copy No. 13 - H. W. Pierce
Copy No. 23 - R. L. Rickett
Copy No. 14 - E. C. Smith
Copy No. 15 - T. T. Watson
Copy No. 24 - A. G. Bissell, Bureau of Ships, Liaison
Copy No. 25 - Mathew Letich, American Bureau of Shipping, Liaison

Copy No. 26 - James McIntosh, U. S. Coast Guard, Liaison
Copy No. 27 - E. Rassman, Bureau of Ships, Liaison
Copy No. 28 - Comdr. R. D. Schmidtman, U. S. Coast Guard, Liaison
Copy No. 29 - T. L. Soo-Hoo, Bureau of Ships, Liaison
Copy No. 30 - Wm. Spraragen, Welding Research Council, Liaison
Copy No. 31 - R. E. Wiley, Bureau of Ships, Liaison
Copy No. 32 - J. L. Wilson, American Bureau of Shipping, Liaison

Ship Structure Committee

Copy No. 33 - Rear Admiral Ellis Reed-Hill, USCG - Chairman
Copy No. 34 - Rear Admiral Charles D. Wheelock, USN, Bureau of Ships
Copy No. 35 - Brigadier General Paul F. Yount, War Department
Copy No. 36 - Captain J. L. McGuigan, U. S. Maritime Commission
Copy No. 37 - D. P. Brown, American Bureau of Shipping
Copy No. 3 - V. H. Schnee, Committee on Ship Construction - Liaison

Ship Structure Subcommittee

Copy No. 38 - Captain C. M. Tooke, USN, Bureau of Ships, Chairman
Copy No. 39 - Captain R. A. Hinners, USN, David Taylor Model Basin
Copy No. 40 - Comdr. R. H. Lambert, USN, Bureau of Ships
Copy No. 28 - Comdr. R. D. Schmidtman, USCG, U. S. Coast Guard Headquarters
Copy No. 41 - W. G. Frederick, U. S. Maritime Commission
Copy No. 42 - Hubert Kempel, Office, Chief of Transportation, War Department
Copy No. 25 - Mathew Letich, American Bureau of Shipping
Copy No. 26 - James McIntosh, U. S. Coast Guard
Copy No. 43 - R. M. Robertson, Office of Naval Research, USN
Copy No. 44 - V. L. Russo, U. S. Maritime Commission
Copy No. 31 - R. E. Wiley, Bureau of Ships, USN
Copy No. 32 - J. L. Wilson, American Bureau of Shipping
Copy No. 16 - Finn Jonassen, Liaison Representative, NRC
Copy No. 45 - E. H. Davidson, Liaison Representative, AISI
Copy No. 46 - Paul Gerhart, Liaison Representative, AISI
Copy No. 30 - Wm. Spraragen, Liaison Representative, WRC

Navy Department

Copy No. 47 - Comdr. R. S. Mandelkorn, USN, Armed Forces Special Weapons Project
Copy No. 24 - A. G. Bissell, Bureau of Ships
Copy No. 48 - A. Amirikian, Bureau of Yards and Docks, U.S. Navy
Copy No. 49 - J. W. Jenkins, Bureau of Ships
Copy No. 50 - Noah Kahn, New York Naval Shipyard
Copy No. 51 - E. M. MacCutcheon, Jr., David Taylor Model Basin
Copy No. 52 - W. R. Osgood, David Taylor Model Basin
Copy No. 53 - N. E. Promisel, Bureau of Aeronautics
Copy No. 54 - John Vasta, Bureau of Ships
Copy No. 55 and 56 - U. S. Naval Engineering Experiment Station
Copy No. 57 - New York Naval Shipyard Material Laboratory
Copy No. 58 - Industrial Testing Laboratory, Philadelphia Naval Shipyard
Copy No. 59 - Philadelphia Naval Shipyard
Copy No. 60 - San Francisco Naval Shipyard
Copy No. 61 - Boston Naval Shipyard, Attn: Welding Engineer

Copy No. 62 - Charleston Naval Shipyard, Attn: Welding Engineer
Copy No. 63 - Long Beach Naval Shipyard, Attn: Welding Engineer
Copy No. 64 - Mare Island Naval Shipyard, Attn: Welding Engineer
Copy No. 65 - Norfolk Naval Shipyard, Attn: Welding Engineer
Copy No. 66 - Portsmouth Naval Shipyard, Attn: Welding Engineer
Copy No. 67 - Puget Sound Naval Shipyard, Attn: Welding Engineer
Copy No. 68 - David Taylor Model Basin, Attn: The Library (330c
Copies No. 69 and 70 - Publications Board, Navy Dept. via Bureau of Ships, Code
Copies No. 71 and 72 - Technical Library, Bureau of Ships, Code 337-L

U. S. Coast Guard

Copy No. 73 - Captain R. E. Lank, Jr., USCG
Copy No. 74 - Captain G. A. Tyler, USCG
Copy No. 75 - Testing and Development Division
Copy No. 76 - U. S. Coast Guard Academy, New London

U. S. Maritime Commission

Copy No. 77 - E. E. Martinsky

Representatives of American Iron and Steel Institute
Committee on Manufacturing Problems

Copy No. 78 - C. M. Parker, Secretary, General Technical Committee
American Iron and Steel Institute
Copy No. 18 - L. C. Bibber, Carnegie-Illinois Steel Corp.
Copy No. 8 - C. H. Herty, Jr., Bethlehem Steel Company
Copy No. 14 - E. C. Smith, Republic Steel Company

Welding Research Council

Copy No. 79 - C. A. Adams
Copy No. 80 - Everett Chapman
Copy No. 81 - LaMotte Grover
Copy No. 30 - Wm. Spraragen

Committee on Ship Steel

Copy No. 82 - R. F. Mehl, Chairman
Copy No. 8 - C. H. Herty, Jr., Vice Chairman
Copy No. 83 - Wm. M. Baldwin, Jr.
Copy No. 84 - Chas. S. Barrett
Copy No. 85 - R. M. Brick
Copy No. 86 - S. L. Hoyt
Copy No. 87 - I. R. Kramer
Copy No. 21 - M. W. Lightner
Copy No. 88 - T. S. Washburn
Copy No. 16 - Finn Jonassen, Technical Director
Copy No. 89 - R. H. Raring, Technical Secretary

Copy No. 90 - C. R. Soderberg, Chairman, Div. Engineering & Industrial Res., NRC
Copy No. 3 - V. H. Schnee, Chairman, Committee on Ship Construction
Copy No. 16 - Finn Jonassen, Research Coordinator, Committee on Ship Construction
Copy No. 91 - L. J. Ebert, Investigator, Research Project SR-99

Copy No. 92 - A. W. Dana, Investigator, Research Project SR-99
Copy No. 93 - Samuel T. Carpenter, Investigator, Research Project SR-98
Copy No. 10 - J. M. Lessells, Investigator, Research Project SR-101
Copy No. 94 - C. W. MacGregor, Investigator, Research Project SR-102
Copy No. 95 - C. B. Voldrich, Investigator, Research Project SR-100
Copy No. 96 - Clarence Altenburger, Great Lakes Steel Company
Copy No. 97 - A. B. Bagsar, Sun Oil Company
Copy No. 98 - E. L. Cochrane, Massachusetts Institute of Technology
Copy No. 99 - George Ellinger, National Bureau of Standards
Copy No. 100 - M. Gensamer, Carnegie-Illinois Steel Corporation
Copy No. 101 - M. F. Hawkes, Carnegie Institute of Technology
Copy No. 102 - W. F. Hess, Rensselaer Polytechnic Institute
Copy No. 103 - O. J. Horger, Timken Roller Bearing Company
Copy No. 104 - Bruce Johnston, Fritz Laboratory, Lehigh University
Copy No. 105 - P. E. Kyle, Cornell University
Copy No. 106 - J. R. Low, Jr., General Electric Company
Copy No. 107 - N. H. Newmark, University of Illinois
Copy No. 108 - J. T. Norton, Massachusetts Institute of Technology
Copy No. 109 - W. A. Reich, General Electric Company
Copy No. 110 - L. J. Rohl, Carnegie-Illinois Steel Corp.
Copy No. 111 - W. P. Roop, Swarthmore College
Copy No. 112 - C. E. Sims, Battelle Memorial Institute
Copy No. 113 - R. D. Stout, Lehigh University
Copy No. 114 - Saylor Snyder, Carnegie-Illinois Steel Corporation
Copy No. 115 - J. F. Wallace, Watertown Arsenal Laboratory (Staff)
Copies 116 thru 140 - Sir Charles Wright, British Joint Services Mission, (Navy)
Copy No. 141 - Carl A. Zapffe, Carl A. Zapffe Laboratories
Copy No. 142 - International Nickel Co., Inc., Attn. T. N. Armstrong
Copy No. 143 - Transportation Corps Board, Brooklyn, New York
Copies 144 thru 148 - Library of Congress via Bureau of Ships, Code 330c
Copy No. 149 - File Copy, Committee on Ship Steel
Copy No. 150 - NACA, Attn, Materials Research Coordination, USN
Copies 151 thru 155 - Bureau of Ships

Copy No. 156 -
Copy No. 157 -
Copy No. 158 -
Copy No. 159 -
Copy No. 160 -
Copy No. 161 -
Copy No. 162 -
Copy No. 163 -
Copy No. 164 -
Copy No. 165 -
Copy No. 166 -
Copy No. 167 -
Copy No. 168 -
Copy No. 169 -
Copy No. 170 -
Copy No. 171 -
Copy No. 172 -
Copy No. 173 -
Copy No. 174 -
Copy No. 175 -

(Total 175 copies)

TECHNICAL REPORT

on

THE FUNDAMENTAL FACTORS INFLUENCING THE BEHAVIOR
OF WELDED STRUCTURES UNDER CONDITIONS OF MULTIAXIAL
STRESS, AND VARIATIONS OF TEMPERATURE, STRESS
CONCENTRATION, AND RATES OF STRAIN

by

G. Sachs, L. J. Ebert and A. W. Dana

Case Institute of Technology
Under Bureau of Ships Contract NObs-45470

In Cooperation With

Committee on Ship Construction
Division of Engineering and Industrial Research
National Research Council

Cleveland, Ohio

TABLE OF CONTENTS

	Page
Contents	i
List of Figures	ii
Abstract	iii
Introduction	1
Material	3
Procedure	4
Welding Techniques	4
Specimen Preparation	6
Testing Procedure	6
Results	7
Hardness Surveys	7
Metallurgical Structure	8
Eccentric Notch Tests	9
Discussion of Results	12
Unaffected Plate	12
As Welded Plate	14
Conclusions	17
Acknowledgments	17
Bibliography	18

LIST OF FIGURES

	<u>Page No.</u>
Fig. 1 -----Plate Preparation	19
Fig. 2 -----Welding Procedure	19
Fig. 3 -----Location of Specimens in Welded Plate	19
Fig. 4 -----Location of Specimen in Thickness Dimension of Plate	19
Fig. 5 -----Test Specimen Geometry	19
Fig. 6 -----Photograph of Testing Setup	20
Fig. 7 -----Schematic Sketch of Loading Method	21
Fig. 8 -----Hardness Distributions Across Weld	22
Fig. 9 -----Metallurgical Structure of "C" Steel Weldment at Various Distances from the Weld Centerline.	23
Fig. 10 -----Variation of Eccentric Notch Strength with Testing Temperature for Unaffected Plate	24
Fig. 11 -----Statistical Analysis of Data from Fig. 10	24
Fig. 12--16-- Distribution of Eccentric Notch Strengths across Weld Joints at Various Temperatures	25-27
Fig. 17 -----Average Curves Showing Distribution of Eccentric Notch Strength Across the Weld Joints with Testing Temperature as Parameter	27
Fig. 18 -----Variation of Eccentric Notch Strength with Testing Temperature at Various Selected Distances from the Weld Centerline	28
Fig. 19 -----Variation of Transition Temperature with Distance from the Weld Centerline	28

ABSTRACT

A detailed study was made of a low carbon ship plate steel, both "as received" and "as welded", by utilizing hardness tests and eccentric notch bar static tension tests at various temperatures. Considerable non-uniformity was revealed in the "as received" plate, that is, localized areas showed relatively high transition temperatures. A brittle-ductile transition zone was found to exist between -40 and -80°F for the investigated steel.

A zone of maximum hardness occurred at the junction of the weld metal and the heat affected zone, from which the hardness (Rockwell B) approached that of the unaffected plate. A zone of minimum ductility (eccentric notch strength) was found 0.3 to 0.4 inch from the weld centerline. This zone was located by using the eccentric notch bar tension test at low temperatures.

The zone of low ductility is thought to be the zone which is heated to the maximum subcritical temperature, with the further possibility of embrittlement by strain aging and intermediate transformation products.

INTRODUCTION

This report summarizes the work completed on a project sponsored by the Ship Structure Committee and conducted under U. S. Navy contract No. NObs-45470 and covers the period from July 1, 1947 to September 1, 1948.

Recent investigations have shown that a steel structure may fail in a brittle manner if subjected to severe service conditions. These service conditions may include multiaxial stresses (biaxial or triaxial stress states), stress concentration, low temperature, and section size. Considerable attention has been drawn to these factors with the occurrence of failures in welded merchant ships.

If a metal is loaded under a combination of the above mentioned embrittling factors, the ductility may be reduced to a low value. Under these conditions the ductility becomes a more important measure of the structure's resistance to fracture than its strength. For example, if a crack is assumed to be propagating through a welded ship structure, several of the above mentioned embrittling factors are present. If the metal is capable of retaining a relatively high ductility, redistribution of stress occurs with plastic flow and the fracture probably will not be major in nature. However, if the ductility is reduced to a low value, the crack may well propagate with little difficulty, and be accompanied by small energy absorption.

Since the number of failures in ship structures increased with the adoption of welding techniques, it was thought that welding procedures caused some change in the properties of the plate. Investigations (1) (2)* showed that the process of welding altered the microstructure of the plate material adjacent to the weld in such a manner as to make the metal, in some cases, more notch sensitive than the unaffected plate material. It would seem,

*Numbers in parentheses refer to the bibliography at the end of the report.

therefore, that welding may cause an otherwise ductile steel to react in a brittle manner. Furthermore, if the welded structure is viewed as a unit it would be expected that under severe loading conditions fracture would be initiated or at least propagated through the region of lowest ductility.

Tests on large welded structures and assemblies (3) (4) have yielded data on the over-all behavior of welded structures. However, these tests are costly and, therefore, the need was recognized for a test which would allow investigation of small volumes of metal and still include the various embrittling factors.

Several types of specimens have been designed to satisfy the above mentioned requirements. The "cleavage-tear test" (5) combines eccentric loading with a stress raiser. However, the tear test averages out a fairly large volume of metal. On the other hand, the eccentric notch bar static tension test permits the testing of small volumes of metal and includes the same eccentric loading in the presence of a stress raiser as the tear test.

It has been shown by several investigators that this test can be used to differentiate among various heat treated steels (6) and can also be used to reveal brittle zones in welded plate (2). In this test the nonuniform stress distribution of bending is superimposed on the effect of the stress raiser (notch) to yield a localized point of high longitudinal tension stresses. It can be seen, therefore, that the small volume of metal subjected to this high tension stress will determine the properties of the specimen. If this volume of metal has a low ductility, fracture will be initiated at this point. On the other hand, if the inherent ductility is relatively large, the eccentricity will be gradually eliminated as plastic flow occurs and the strength properties will approach those of the concentric notch test (7). For strains below the

necking point the eccentric notch strength* has been found to be directly proportional to the notch ductility (7).

Another advantage of the eccentric notch test is the fact that the added effect of embrittlement at low temperatures is easily superimposed.

In view of the above considerations the eccentric notch bar static tension test was chosen for the investigation reported herein.

MATERIAL

The ship plate selected for the initial phases of this investigation was one of the so-called "project" steels which have been investigated by other groups under the sponsorship of the Ship Structure Committee. For the purposes of this investigation, steel C, which earlier research work had shown to have a high transition temperature, was chosen. It was felt that any welding effects would be at a maximum in this plate. The properties reported for "C" steel (8) (9) are as follows:

TABLE I
PROPERTIES OF "C" STEEL PLATE

--Chemical Analysis--					
<u>Carbon</u>	<u>Manganese</u>	<u>Phosphorous</u>	<u>Sulfur</u>	<u>Silicon</u>	<u>Aluminum</u>
0.24%	0.48%	0.012%	0.026%	0.05%	0.016%
<u>Nickel</u>	<u>Copper</u>	<u>Chromium</u>	<u>Molybdenum</u>	<u>Tin</u>	<u>Nitrogen</u>
0.02%	0.03%	0.03%	0.005%	0.003%	0.009%
<u>Vanadium</u>	<u>Arsenic</u>				
0.02%	0.01%				
--Mechanical Properties					
<u>Yield Point</u> <u>psi</u>		<u>Tensile Strength</u> <u>psi</u>		<u>Elongation</u> <u>in 8 inches</u> <u>percent</u>	
39,000		67,400		25.5	

* Ratio of maximum load to original area.

The steel was semi-killed with 1/3 lb. aluminum per ton of steel being added to the mold and was available as 3/4 inch, as-rolled, plate.

PROCEDURE

Welding Techniques

The welding of the ship plate was performed at the Battelle Memorial Institute under closely controlled conditions. Details regarding the welding procedure are given in Figs. 1 and 2.

Each weldment was constructed of two plates, 9" x 24" x 3/4" in dimensions.* These plates were sectioned from one large plate by flame cutting and then 3/4 inch was machined from the edges to be welded in order to eliminate the effect of the flame cutting. The cut faces were then machined to a 30 degree bevel with a 1/8 inch root face symmetrical with respect to the center plane of the plate. The machined edges were then magnifluxed for evidences of laminations or other defects.

The plates were insulated from the steel welding table by asbestos sheets and the double-V joint was set up using a 3/16 inch root cap and a copper back-up bar coated with a thin layer of wollastonite. The plates were then tack welded using one inch tacks at each end and at the center of the plates.

A set of two steel lugs 3/4 inch thick were welded on both ends of the assembly for ground connections to the welding machine. In each case the ground connections were adjusted so that the direction of welding was away from them. It was felt that this procedure would reduce the amount of arc blow. The welding data are given in Table II.

* The 24" dimension was taken parallel to the rolling direction of the plate.

No restraint other than the tack welds was used on the weldments and since two inches from each end of the plate were to be discarded, no runoff tabs were required. All welding was manual using E6010 electrodes, 3/16 inch in diameter, with reverse polarity.

TABLE II
WELDING DATA

Harnischfeger - D. C. Welder		
	Electrode 3/16 E 6010	Reversed Polarity
Current	150 Amps	Pass 1
	165 Amps	Passes 2-6
Voltage	25 Volts	
Welding Speed	3.6 in/min	Pass 1
	4.8 in/min	Passes 2-6
Electrode Burn Off Rate	8.5 in/min	

The weldments were preheated to 100°F prior to the first weld pass. After each pass the weld joint was cooled normally in air until the temperature was again 100°F, and then the next pass was made.

Before welding, the length of the joint was marked at one inch intervals with 600°F Tempilaq. After each weld pass was completed, the position of the 600°F isotherm was measured. New Tempilaq was applied prior to each pass until the weldment was completed.

After completion of welding, the welded joint was sand blasted and then radiographed for weld imperfections.

Three weldments were made for this phase of the investigation.

Specimen Preparation

In preparing the specimens, 1/2 inch strips were cut from the welded plates perpendicular to the weld, one strip being used for hardness surveys. Each strip was etched with a 10 percent solution of ammonium persulfate so that the weld area was visible and, in particular, so that the weld centerline could be accurately located. The specimen locations were then laid out so that the notch bottom was the desired distance from the weld centerline, and so that the fiber carrying the highest tension load was along the centerline of the plate. The general layout of specimens for a weldment is given in Fig. 3 and the location in the thickness dimension of the plate in Fig. 4. The distribution of specimens shown in Fig. 3 is for the determination of the properties across the weld. Additional specimens to investigate the properties of the unaffected plate were located four to five inches from the weld centerline.

The notch test specimen is shown in Fig. 5. These specimens had a circumferential 60 degree V-notch, removing 50 percent of the cross sectional area, and a root radius less than 0.001 inch.

Testing Procedure

The specimens were tested in fixtures designed to yield a nominal notch eccentricity of 1/4 inch, see Fig. 6. The specimens were placed in adapters so that the fiber to be tested was on the tension side, Fig. 7. The tank for low temperature testing is shown in Fig. 6.

After the specimen was positioned, the entire assembly was cooled to 5°F below the desired testing temperature. The setup was then allowed to stand until the testing temperature was reached. The warming cycle was slow

and occurred at a rate of approximately 1 to 2°F per three minutes. This slow rate of temperature change was accomplished by insulating the cooling tank. Since the time for testing was approximately 1/2 minute, it was concluded that the tests were performed at a constant temperature.

Cooling was accomplished by mixtures of isopentane, dry ice, and liquid nitrogen. Temperatures were measured by placing a pentane thermometer directly beside the specimens. All tests were at constant speed and at a low rate of strain.

The eccentric notch strength or ratio of maximum load to original area of the notch cross section was determined for each steel.

After fracture, the fractured surfaces were inspected for flaws.

RESULTS

Hardness Surveys

Hardness distributions for the as welded plate are shown in Fig. 8. Hardness values (Rockwell B) are given for several levels through the plate thickness.

In general, the hardness began to increase at approximately one inch from the weld centerline, becoming a maximum at 0.1 to 0.2 inch in the center of the plate (axis C). A minimum then occurred at the weld centerline. The hardness of the unaffected plate was uniform ($R_B = 75$). Recent hardness surveys (to be reported later) made with a Tukon Microhardness Tester showed that a number of hardness peaks are present in the heat affected zone wherein each weld pass seems to produce a region of hardness. Consequently, the hardness distribution shown in Fig. 8 may be an over-simplified picture of the heat affected zone because the Rockwell B impression averages out the hardness over a fairly extensive region of metal as compared to the micro-hardness indenter.

However, the extent of the heat affected zone can be estimated to be approximately one inch from the weld centerline. As mentioned in the procedure, the position of the 600°F isotherm was measured during welding and was found to be about 0.8 inch from the weld centerline. Temperature measurements that were made on a subsequent "A" steel weldment, welded under similar conditions, showed that the 600°F isotherm measured at the center of the plate was the same distance from the weld centerline as that measured at the plate surface. This would mean, therefore, that the area of the plate exhibiting the sharpest increase in hardness was heated above 600°F during welding. This fact will be discussed further in the Discussion of Results.

Metallurgical Structure

A macrograph and a series of photomicrographs representative of the various structural zones are shown in Fig. 9.

The macrograph shows the overall structure of the weld and the heat affected zone; it can be seen that each weld pass gives rise to a heat affected zone which combines with the zones from the other passes to give an overall heat affected zone.

The series of photomicrographs are representative of the structures encountered in the center of the plate at various distances from the weld centerline.

The weld metal (Fig. 9b) is a fine grained structure which has been obviously refined by the last weld passes. The weld junction is well defined by the sudden large change in grain size at 0.08 inch (Fig. 9c). With increasing distance from the weld centerline the grain size of this structure which has been cooled from above the upper critical decreases (Fig. 9d).

The structure resulting from transformation from the temperature range between the upper and lower critical is shown in Fig. 9e. This structure merges into the structure of the parent plate (Fig. 9f) which is composed of pearlite surrounded by ferrite.

Eccentric Notch Tests

Two series of tests were conducted on this phase of the investigation. The first series consisted of investigating the eccentric notch properties of the unaffected plate as a function of testing temperature. The second series of tests was on the distribution of eccentric notch properties across the welds at selected testing temperatures.

1. Unaffected Base Plate - The results of the eccentric notch tests on the unaffected base plate are shown in Fig. 10. In view of the hardness distributions, tests on material beyond one inch from the weld centerline were considered to be representative of the unaffected plate. Twenty-five or more tests were made at most of the temperatures investigated.

A ductile-brittle transition zone* is seen in Fig. 10 to occur between -40 to -80°F. It is also noted that considerable scatter occurred at the various testing temperatures. Normally, as the testing temperature is lowered the degree of scatter is small until the transition zone is reached. At this point, previous investigations on the effect of testing temperature indicate considerable scatter should occur. While this latter case was found in the transition zone for the plate, the overall degree of variation seemed to be greater than normally expected.

In addition, the data shown in Fig. 10 further indicate a tendency for certain values of notch strength to occur with greater frequency than others at a particular testing temperature. With this in mind, the data in Figure 10

* As pointed out in the introduction, a change from high to low values of eccentric notch strength is accompanied by a change in notch ductility in the same direction.

were analyzed statistically, Fig. 11. It is seen that at room temperature and at -10°F the results were fairly uniform. However, at lower temperatures the distribution of properties changes appreciably. The number of tests producing low values increased, yielding a double maximum. At the lowest temperature, -80°F , most of the tests resulted in low values, but high values still occurred. In addition both peaks occurred at approximately the same value of notch strength for the various testing temperatures. It should be pointed out that phenomena such as these can only be observed if a sufficiently large number of tests are performed to make a statistical analysis possible.

The fractured surfaces of these specimens were examined for the type of fracture. All of the fractures for specimens tested at -10°F and below were of the cleavage type. At room temperature the specimens showed 10 to 15 percent shear with the remainder cleavage.

2. As Welded Plate - In Figs. 12 to 16 the distributions of eccentric notch strengths across the weldments are shown for various testing temperatures.

The results at room temperature, Fig. 12, indicate that the eccentric notch strength was fairly uniform across the weld. However, a region of high notch strengths, indicated by the dashed lines, probably was missed. This would appear to be the case if the other distributions of notch strengths and the hardness surveys are considered. In general, however, it can be said that the distribution of eccentric notch strength at room temperature follows the hardness distribution.

The distributions at the lower temperatures have the same general trends. The unaffected plate showed constant properties up to the heat affected zone where a pronounced minimum occurred at 0.3 to 0.4 inch from the weld centerline.

The eccentric notch strength then rose to a maximum value in the structure near the junction of the heat affected zone and the weld metal (approximately 0.15 inch from the weld centerline). A lower notch strength was then observed in the weld metal.

It is of interest to note that while the degree of plus-minus variation increased for the unaffected plate with decreasing testing temperature, the degree of variation decreased for the zone showing minimum properties. This would mean that at the testing temperature, -80°F , the material which showed the minimum eccentric notch strength values was almost completely notch sensitive and brittle. At the same time the weld metal, especially at the weld centerline, evidenced little scatter and was apparently quite uniform. Since all of the specimens were taken from the center of the plate thickness, the specimens from the weld had a uniform refined grain size because of the re-heating from the final weld passes.

The minimum in notch properties occurred at the same location and became more pronounced as the testing temperature was lowered. These phenomena can be seen if average curves for the various testing temperatures are compared, Fig. 17. Furthermore, it should be noted that the maximum value of notch strength had approximately the same absolute value and also the same location for the various testing temperatures. The values for the parent plate show the decrease in notch strength with temperature.

Subsequent tests on A steel weldments, welded under the same welding conditions, have shown a similar minimum in eccentric notch strength at 0.3-0.4 inch from the weld centerline and a maximum at 0.1-0.2 inch.

By cross plotting the eccentric notch strength values* for a given location as a function of temperature, it is possible to further investigate the

* Values taken from average curves in Fig. 17.

transition temperatures of various positions in the plate. Four locations were selected: 1) The weld centerline, 2) 0.1-0.2 inch from the weld centerline, 3) 0.3-0.4 inch from the weld centerline, and 4) the unaffected plate. These data which are plotted in Fig. 18 show that the 0.1-0.2 inch location did not exhibit a transition temperature in the range of testing temperatures investigated. The weld metal also showed no transition temperature in the range investigated, but probably would have a higher transition temperature than the 0.1-0.2 location. On the other hand, the unaffected plate and the 0.3-0.4 inch position did show transition ranges as indicated. The difference in these transition temperatures can be shown by plotting the transition temperatures from Fig. 18 as a function of distance from the weld centerline, Fig. 19. The zone of low ductility, 0.3-0.4 inch from the weld centerline, is definitely defined by its high transition temperature.

DISCUSSION OF RESULTS

Unaffected Plate

From an examination of the eccentric notch properties of the unaffected plate it is evident that considerable nonuniformity existed in the parent material.

At room temperature, where 25 tests under identical conditions were made, the degree of variation was relatively small. All but three tests fell within \pm 3 to 4 percent of the average value. Of the three remaining tests, one had a value 14 percent above the average and the other two were 8 to 9 percent below the average of the tests. In general, it may be said, that

at room temperature the material was relatively uniform and the method of testing yielded reproducible results. This point is important when considering the results obtained at lower temperatures.

In contrast to the results at room temperature, a great deal of variation in test results occurred as the testing temperature was lowered. For example, at -10°F the results, Fig. 10, began to vary appreciably. This temperature was well above the transition temperature for the parent plate and, therefore, the same type of distribution of eccentric notch strength values as found at room temperature would be expected. However, the distribution of eccentric notch strength values was spread over a greater range of values, the degree of variation being approximately $\pm 10\%$ of the average value with a few tests 15% above and below the average. It would seem quite possible that certain localized positions in the plate had relatively high transition temperatures, which resulted in increased deviation of the test values from the average. Since the eccentric notch specimen tests a localized area of metal, the chances of including these areas of poor properties are quite high.

As the testing temperature was lowered further, the plus-minus variation of the results became increasingly greater. This is explained by the fact that the normal scatter encountered on passing through the transition temperature range was superimposed on that observed at the higher temperature. Then, as the testing temperature became even lower, the areas that yielded high values were embrittled, and the scatter was again reduced. At extremely low temperatures all the values would be low.

It should be pointed out, however, that at a testing temperature of -80°F , high values of notch strength still occurred. It would seem, therefore, that if any treatment were used to improve the plate proper, the result would be seen as a shift of more values to the high side.

As Welded Plate

A recent investigation of the annealing of low carbon steel strip (10) yielded information that may be used to analyze the results of the hardness surveys and distribution of notch strength for the as welded plate. This investigation showed that three factors operate to make a steel hard when cooled.

The first of these is the gamma-alpha transformation which results in reduced grain size and, therefore, higher hardness. It should also be pointed out that if the cooling through the transformation range is sufficiently fast, a martensitic structure results. This structure remains relatively hard but ductile on tempering.

The second factor is termed the solution effect and is essentially the formation of a supersaturated solid solution that is harder than the equilibrium mixture. For steel, this corresponds to the maximum solid solubility of carbon in alpha iron and would depend on very rapid cooling from the lower critical temperature.

The third factor is associated with the second one and results from the precipitation of carbide from the supersaturated solid solution. If the rate of cooling is relatively rapid, but slower than water quenching, these two factors occur more or less simultaneously. However, in any case an increase in hardness accompanied by a decrease in ductility is obtained. It should also be pointed out in connection with these last two effects that the rate of cooling from 600°F has no effect and that apparently no hardening occurs below this temperature. With the foregoing discussion in mind, the conditions on welding may be further analyzed. A temperature gradient existed from the weld centerline into the parent plate that represented all temperatures from the melting point of the metal to room temperature. It is also known that the

cooling rate was fairly rapid since a large volume of relatively cool metal was adjacent to the weld. Therefore, the conditions for hardening outlined above were present.

Examination of the hardness distributions shows that a maximum hardness occurred at the junction of the weld metal and heat affected zone of the plate. This corresponds to the first hardening factor discussed above. From this peak the hardness decreased gradually to the hardness of the unaffected plate. The shape of this curve is similar to the solid solubility line of carbon in alpha iron and should represent also the temperature gradient that was present when cooling began after welding. This decrease in hardness then indicates the varying degrees (decreasing) of magnitude of the last two hardening factors mentioned previously; namely, the solution and aging effects. In addition, two other phenomena should be mentioned in this respect. The position of the 600°F isotherm determined during welding approximated closely the point where the hardness approached that of the unaffected plate. This agrees with the conception that heating and cooling below this temperature does not affect hardening. In addition, a previous investigation on hand welded plate (2) indicated that the hardening beyond the peak can be eliminated by stress relieving followed by slow cooling. This latter phenomenon would be expected if the hardening was caused by the solution and aging effects.

While the hardening effects are fairly clear, the question of the notch strength (ductility) minimum is not nearly as lucid. Unfortunately, hardness is not capable of showing ductility distribution. The maximum hardness was associated with a maximum ductility while a minimum ductility occurred at a lower hardness. However, it may be said that the distribution of eccentric notch strength was the same as the distribution of hardness, except for the notch strength minimum.

Solution and aging effects are accompanied by both increased hardness and decreased ductility, as pointed out. These two effects would be a maximum at the point heated to the maximum subcritical temperature.* Therefore, it is quite possible that these effects are sufficient to result in the observed ductility minimum. In addition, two other possibilities should be mentioned. On cooling from the welding temperature there is a fairly good chance for strain to occur. This phenomenon could lead to strain aging and resulting embrittlement. Secondly, there is also the opportunity for the formation of small quantities of intermediate products. A previous investigation on heat treated low alloy steels (11) showed the damaging effect of these intermediate products on the strength properties of a martensitic structure.

In regard to any treatment designed to improve the properties in the zone of low ductility, the same line of reasoning can be applied as to the properties of the unaffected plate. The absolute value of the notch strength minimum remained practically constant at the lower temperatures, -40 to -80°F. At the same time, the number of tests that yielded high values decreased with decreasing testing temperature. This latter phenomenon resulted in less scattering of values. Any improvement in this zone would necessarily result in a double change in the scattering characteristics. At the higher temperatures the scatter band would be shifted upward or the scattering would be reduced by elimination of the low values. At the lower temperatures the scattering would be increased by the addition of high values.

* It would seem, therefore, that an accurate determination of the thermal gradient would be desirable in future work.

CONCLUSIONS

The following general conclusions may be drawn:

1. A brittle-ductile transition zone existed between -40 and -80°F for the "C" steel plate using the eccentric notch bar tension test.
2. The parent "C" steel plate had localized areas that were notch sensitive at relatively high testing temperatures.
3. Hardness surveys are useful to evaluate the effect of welding on the hardening of the plate material, but do not necessarily indicate ductility.
4. A zone of high hardness and high ductility existed at the junction of the weld metal and heat affected zone.
5. A zone of low ductility does exist and its position can be determined by means of the eccentric notch bar tension tests performed at low temperatures.
6. The ductility (notch strength) minimum was probably associated with the maximum subcritical temperature that was reached on welding the plate. The additional effects of strain aging and intermediate transformation products may also cause this embrittlement.

ACKNOWLEDGMENTS

Acknowledgment is given to the Battelle Memorial Institute, Columbus, Ohio, for welding the plates and particularly, to Messrs. C. B. Voldrich, P. J. Rieppel and R. W. Bennett for their aid in this regard.

The authors are also indebted to Mr. M. H. Jones and Mr. G. S. Sangdahl for their aid in performing the tests.

BIBLIOGRAPHY

1. E. S. Davenport and R. H. Aborn, Metallurgical Aspects of Welding Steel, the Welding Journal, Vol. 15 (1936), p.28-31.
2. W. F. Brown, Jr., L. J. Ebert and G. Sachs, Distribution of Strength and Ductility in Welded Steel Plate as Revealed by the Static Notch Bar Tensile Test, J. Am. Welding Soc. Suppl., Vol. 12 (1947), p. 545-554.
3. E. P. DeGarmo, J. L. Merian and R. C. Grassi, Some Tests of Large Welded Structures, J. Am. Welding Soc., Suppl., Vol. 12 (1947), p. 257-267.
4. A. Boodberg, H. E. Davis, E. R. Parker and G. E. Troxell, Causes of Cleavage Fracture in Ship Plate - Tests of Wide Notched Plates, J. Am. Welding Soc., Suppl., Vol. 13 (1948), p. 186-199.
5. A.B. Bagsar, Development of Cleavage Fractures in Mild Steels, Trans. Am. Soc. Mech. Eng. (1948) in print, Paper No. 47-A-75.
6. G. Sachs, L. J. Ebert and W. F. Brown, Jr., Comparison of Various Structural Alloy Steels by Means of the Static Notch-Bar Tensile Test, Metals Tech., December 1946, T. P. 2110, Trans. Am. Inst. Mining Met. Engrs., Vol. 172 (1947).
7. G. Sachs, J. D. Lubahn and L. J. Ebert, Notched Bar Tensile Test Characteristics of Heat Treated Low Alloy Steels, Trans. Am. Soc. Metals, Vol. 33 (1944), p. 340-395.
8. Technical Progress Report of the Ship Structure Committee, Welding Journal, Vol. 13, 1948, p. 377S-384S.
9. M. Gensamer, E. P. Klier, T. A. Prater, F. C. Wagner, J. O. Mack and J. L. Fisher, Progress Report on Correlation of Laboratory Tests with Full Scale Ship Plate Fracture Tests, National Research Council, Division of Engineering and Industrial Research, Committee on Ship Construction, Report Serial No. SSC-9, March 19, 1947.
10. G. Sachs, L. J. Ebert, G. B. Kasik and J. F. Nejedlik, Fundamentals of Annealing Low Carbon Steel, Part I, Iron and Steel Eng., (1946), November.
G. Sachs, L. J. Ebert, A. W. Dana and M. H. Jones, Fundamentals of Annealing Low Carbon Steel, Part II, Iron and Steel Eng. (1948), January.
11. G. Sachs, L. J. Ebert and W. F. Brown, Jr., Notch-Tensile Characteristics of a Partially Austempered, Low Alloy Steel, Metals Tech., February, 1948, T. P. 2321.

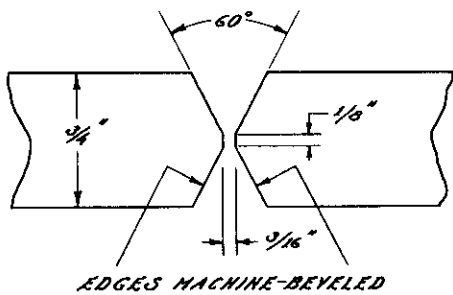

EDGES MACHINE-BEVELED
FIG. 1: PLATE PREPARATION

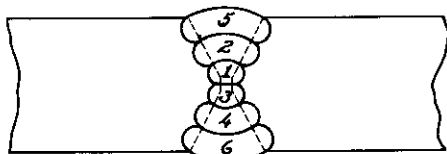

ELECTRODE ~ 3/16" E6010
PASSES 1, 3, 5, 6: SAME DIRECTION
PASSES 2, 4: OPPOSITE DIRECTION

FIG. 2: WELDING PROCEDURE

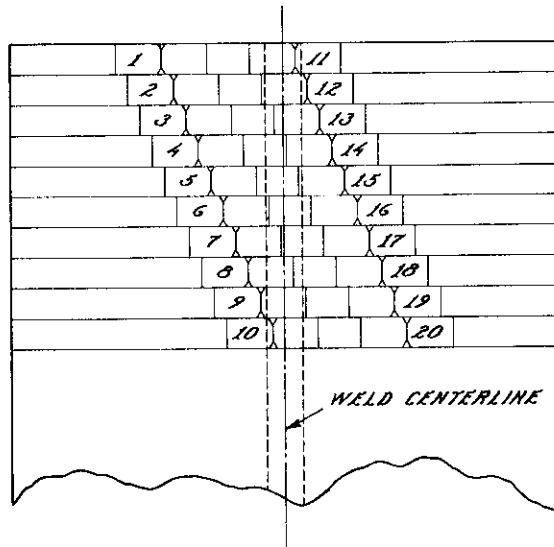

DISTANCE FROM WELD & TO NOTCH BOTTOM	SPECIMEN NO.	DISTANCE FROM WELD & TO NOTCH BOTTOM	SPECIMEN NO.
2.0"	1, 20	1.0"	6, 15
1.8"	2, 19	0.8"	7, 14
1.6"	3, 18	0.6"	8, 13
1.4"	4, 17	0.4"	9, 12
1.2"	5, 16	0.2"	10, 11

FIG. 3: LOCATION OF SPECIMENS IN WELDED PLATE.

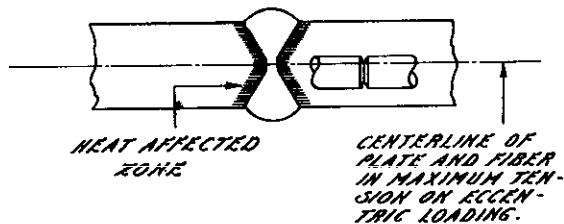

FIG. 4: LOCATION OF SPECIMEN IN THICKNESS DIMENSION OF WELDMENT.

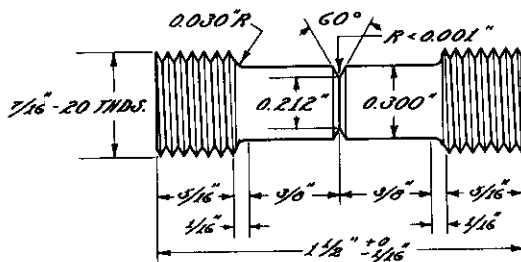

FIG. 5: SPECIMEN WITH 50 PERCENT SHARP NOTCH USED IN ECCENTRIC TESTING.



*FIG. 6: TENSION TEST FIXTURES FOR
PRODUCING A CONTROLLED
ECCENTRICITY OF 1/4 INCH WITH
TANK FOR LOW TEMPERATURE*

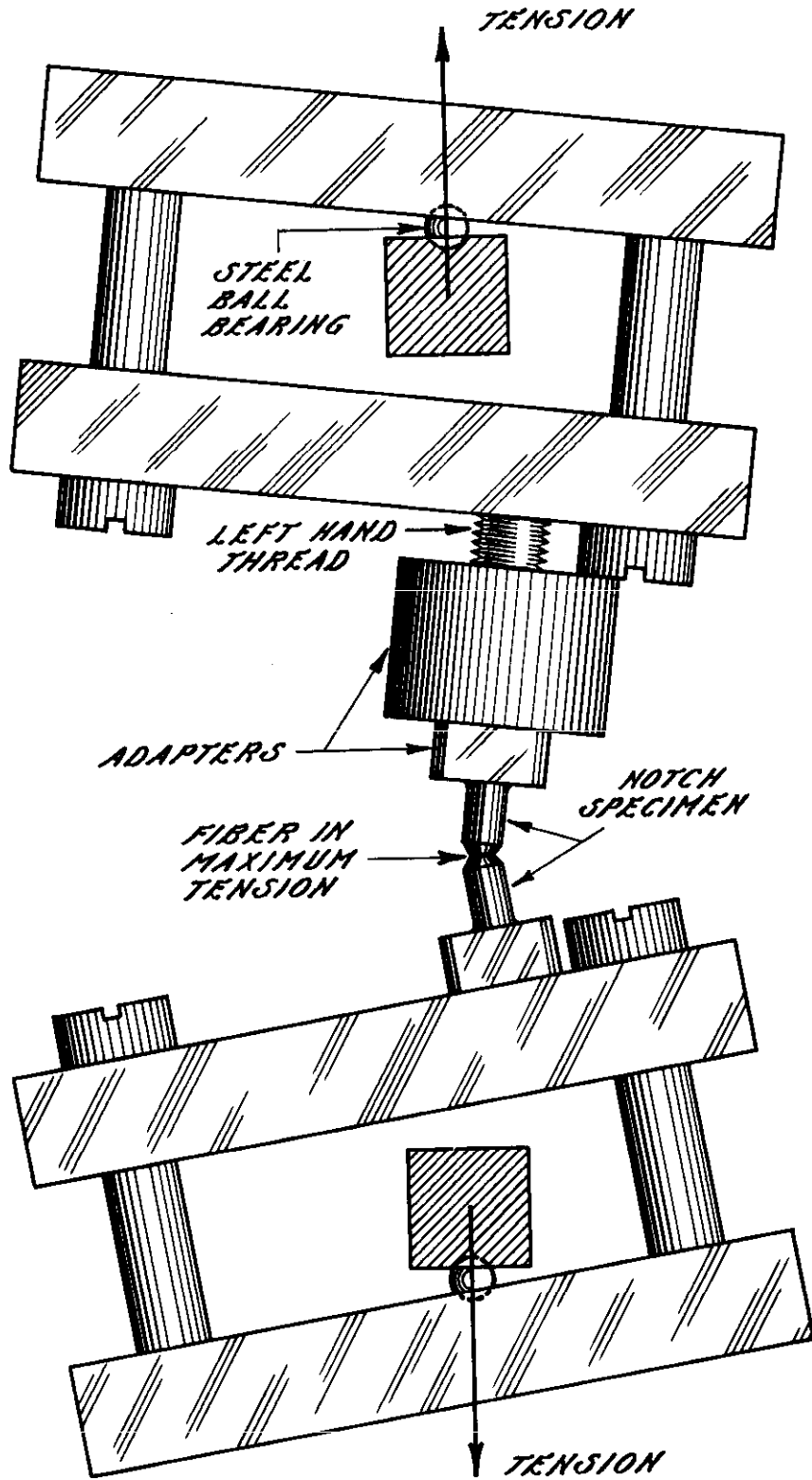

FIG. 7: METHOD OF LOADING TO OBTAIN $\frac{1}{4}$ INCH ECCENTRICITY (ECCENTRICITY AND THE POSITION OF FIXTURES ARE EXAGGERATED).

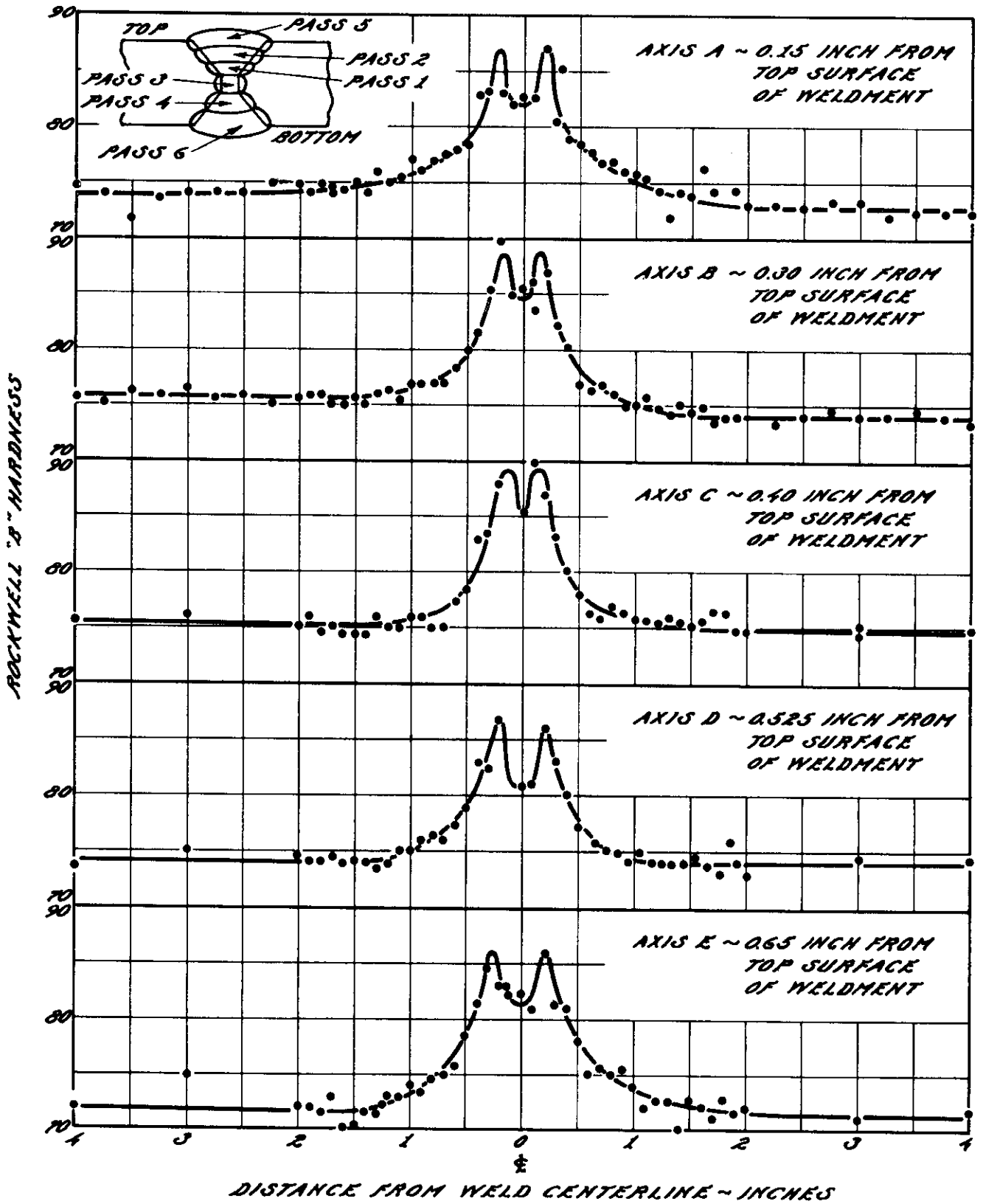
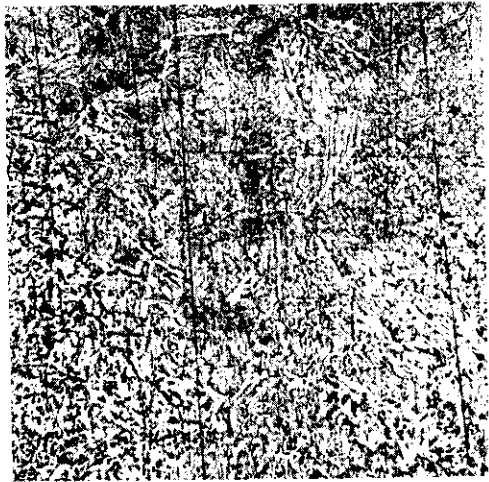
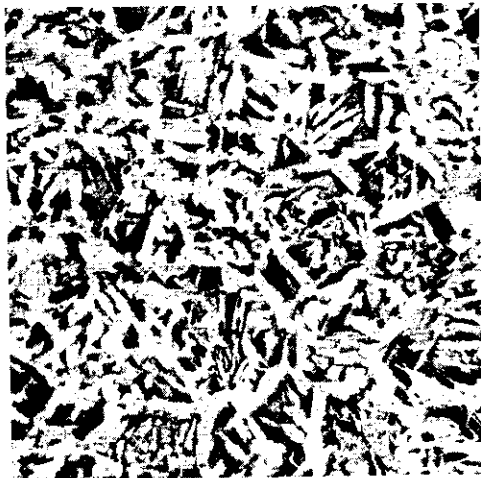

FIG. 8: DISTRIBUTION OF HARDNESS ACROSS WELD AT VARIOUS POSITIONS THROUGHOUT THE THICKNESS OF THE PLATE.



.08 INCH
(c)



30 INCH
(f)

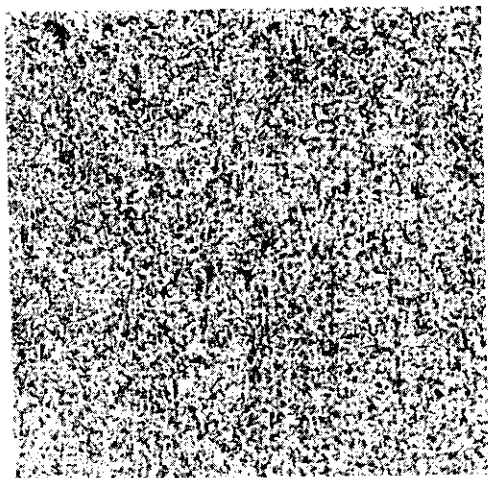

0 INCH
(b)

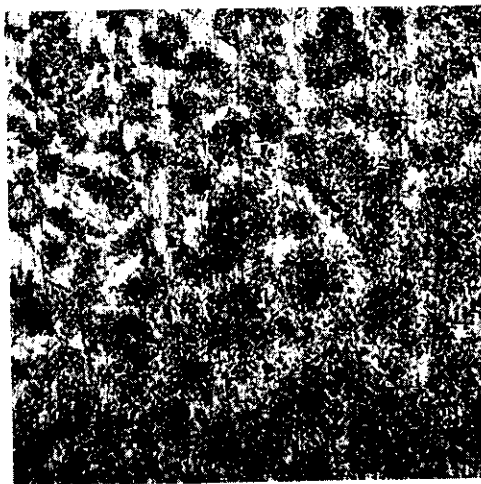

24 INCH
(e)

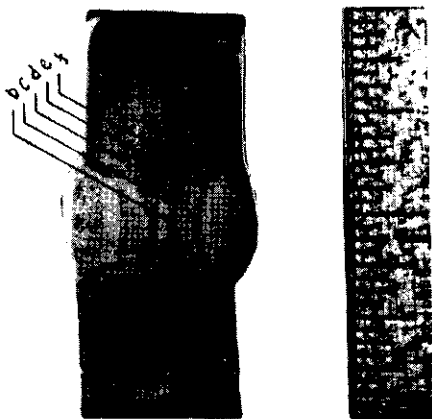

(a)

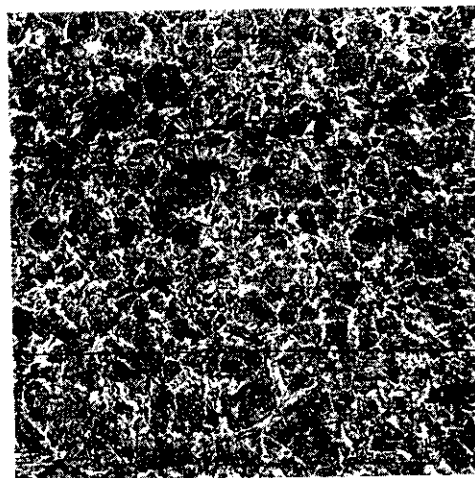

.16 INCH
(d)

FIG. 9: METALLURGICAL STRUCTURE OF "C" STEEL WELDMENT AT VARIOUS DISTANCES FROM THE WELD CENTERLINE (PHOTOMICROGRAPHS AT 100 X)

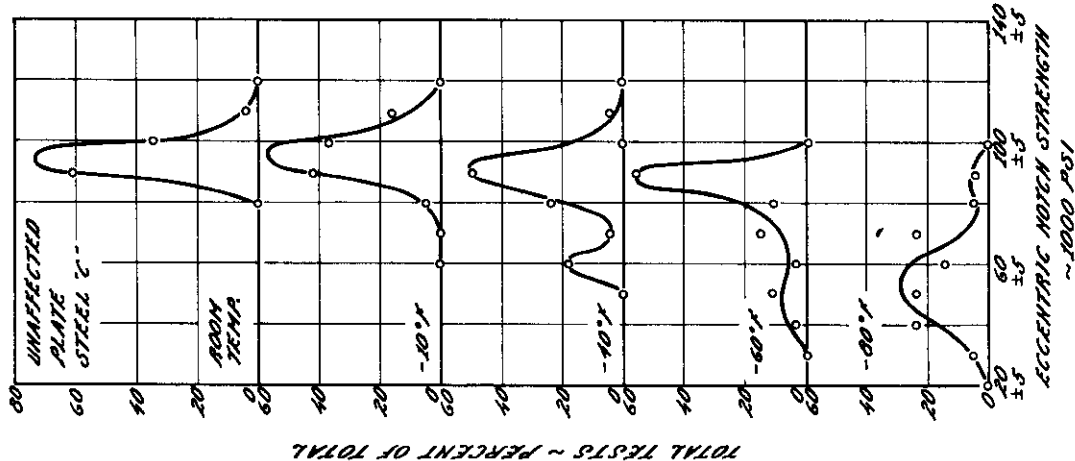

FIG. 11: STATISTICAL DISTRIBUTION OF ECCENTRIC NOTCH PROPERTIES AT VARIOUS TESTING TEMPERATURES FOR UNAFFAFFECTED C STEEL PLATE.

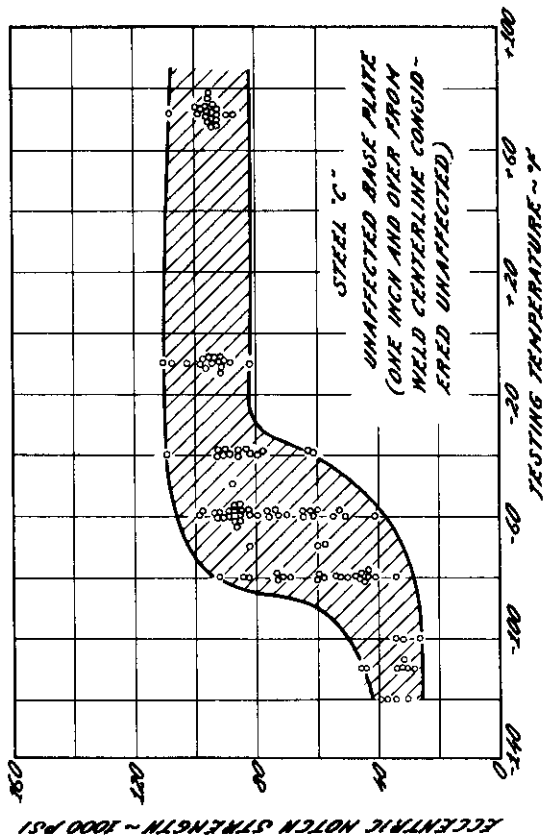

FIG. 12: ECCENTRIC NOTCH STRENGTH AS A FUNCTION OF TESTING TEMPERATURE FOR UNAFFAFFECTED BASE PLATE OF C STEEL.

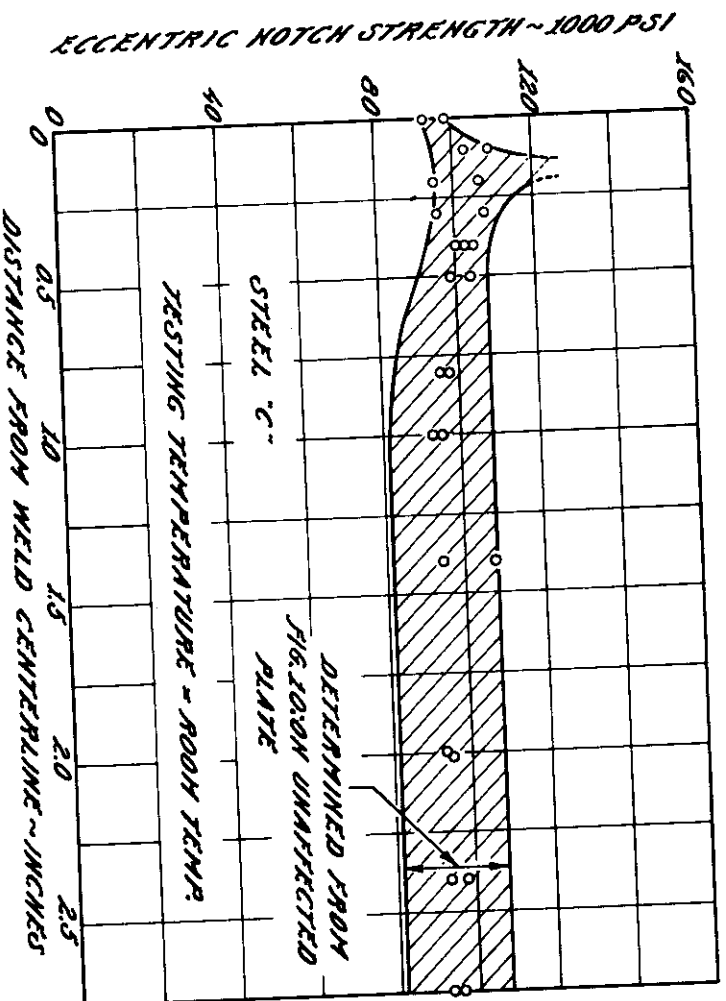

FIG. 12: DISTRIBUTION OF ECCENTRIC NOTCH STRENGTH FOR 'AS WELDED' PLATE AT ROOM TEMPERATURE

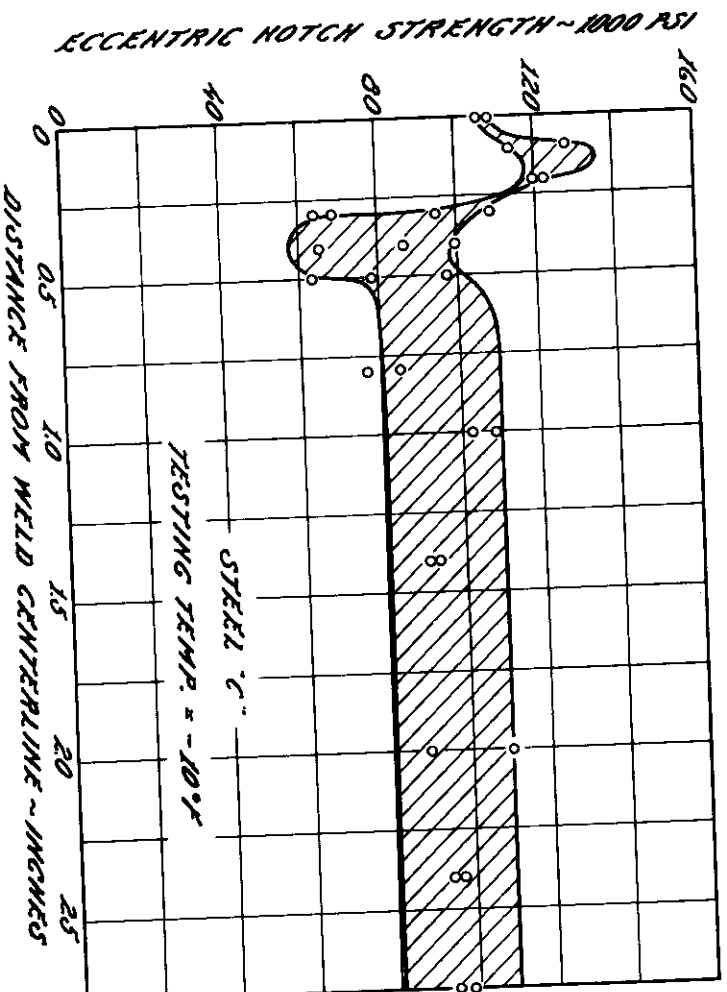

FIG. 13: DISTRIBUTION OF ECCENTRIC NOTCH STRENGTH FOR 'AS WELDED' PLATE AT -10°F

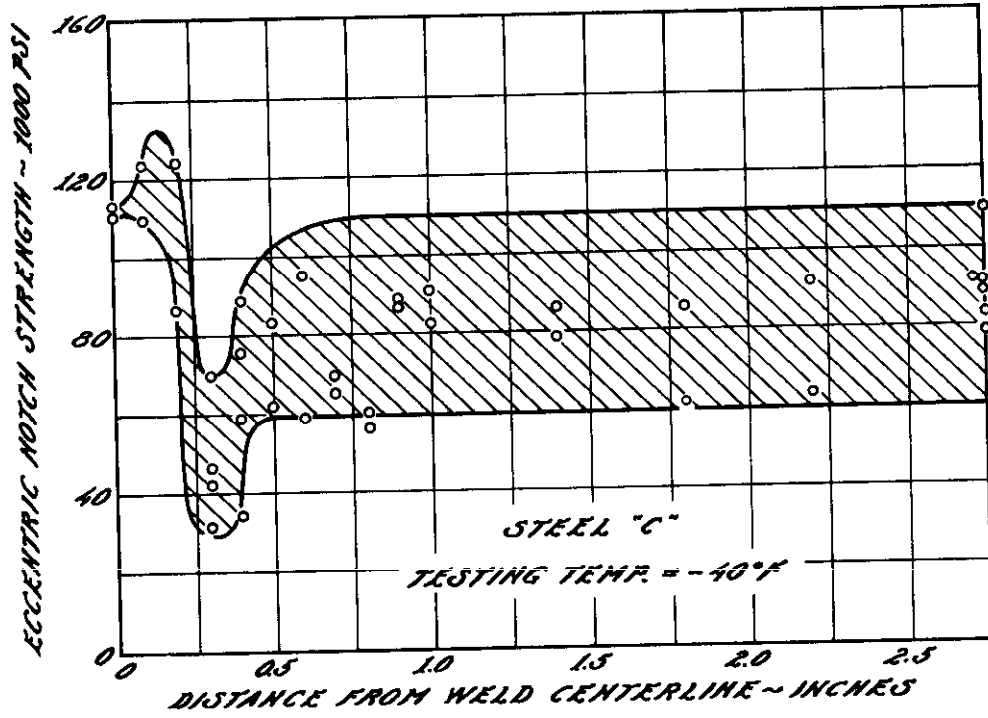

FIG. 14: DISTRIBUTION OF ECCENTRIC NOTCH STRENGTH FOR "AS WELDED" PLATE AT -40°F

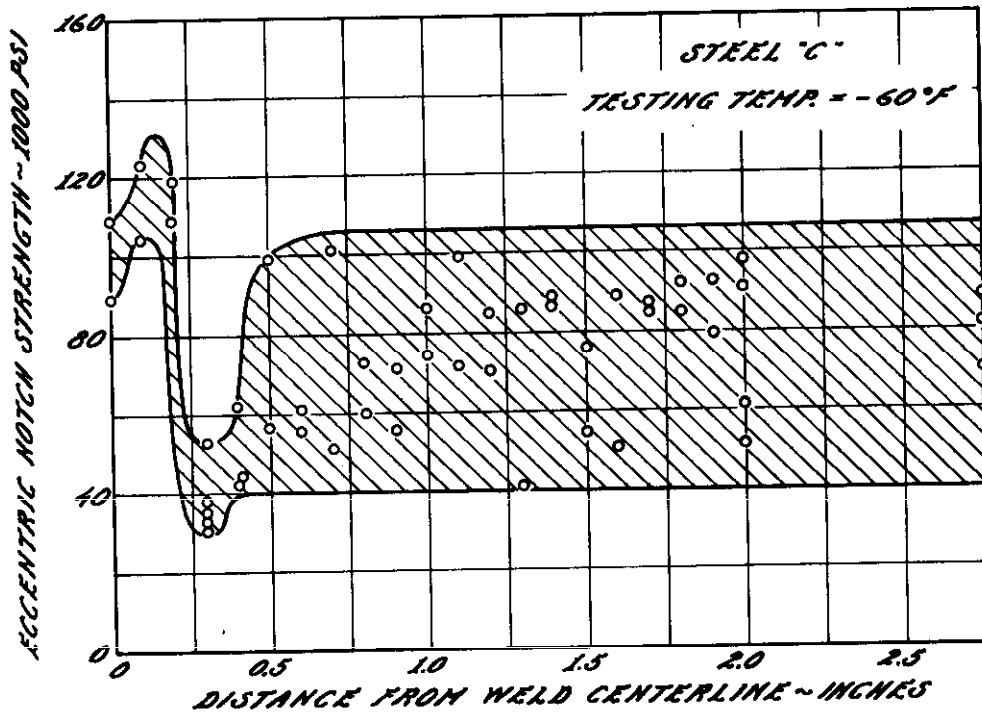

FIG. 15: DISTRIBUTION OF ECCENTRIC NOTCH STRENGTH FOR "AS WELDED" PLATE AT -60°F

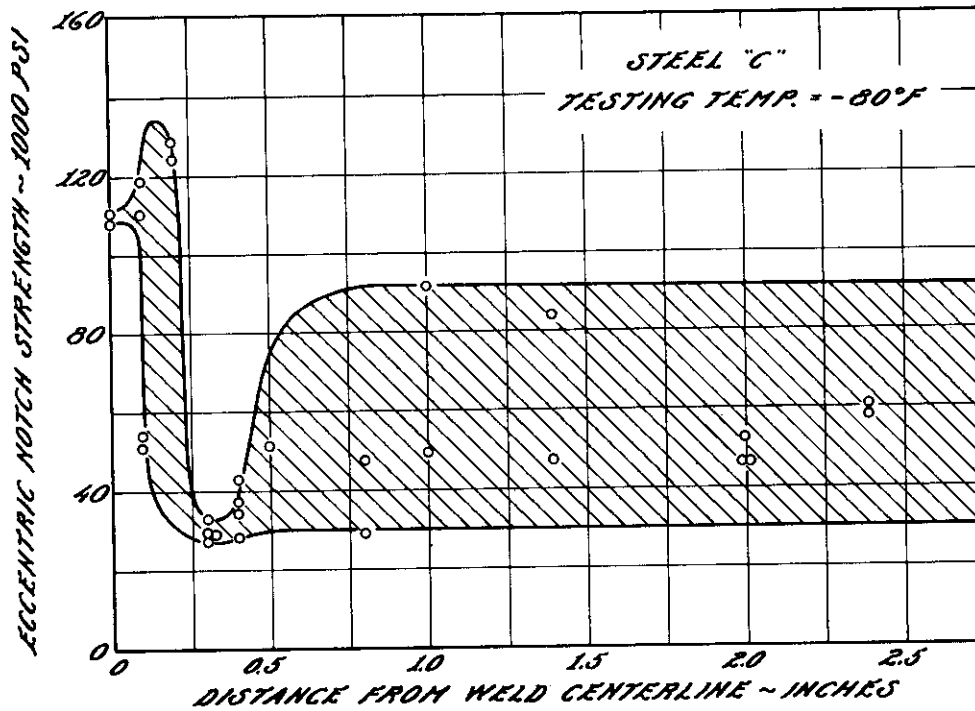

FIG. 16: DISTRIBUTION OF ECCENTRIC NOTCH STRENGTH FOR "AS WELDED" PLATE AT -80°F

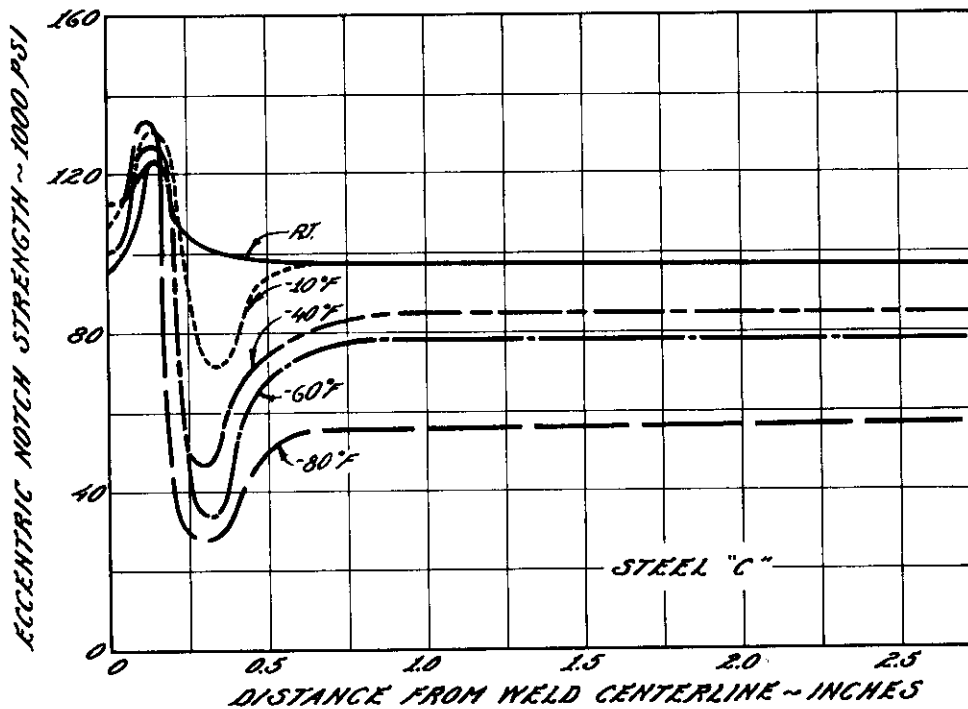

FIG. 17: DISTRIBUTION OF ECCENTRIC NOTCH STRENGTH FOR "AS WELDED" PLATE AT VARIOUS TEMPERATURES (AVERAGE CURVES FROM FIGS. 12-16).

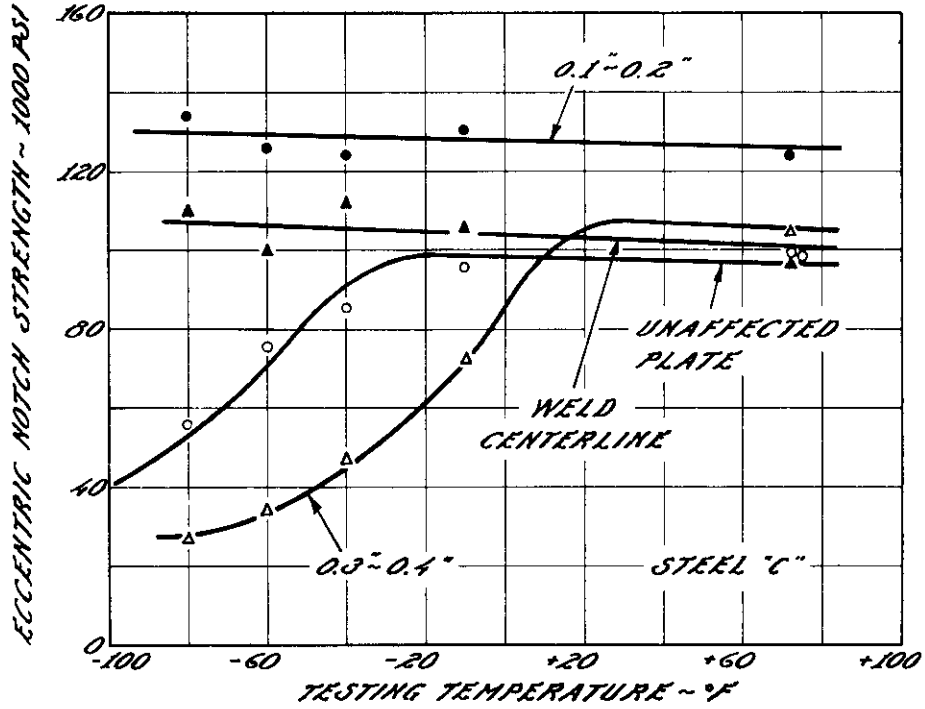

FIG. 18: ECCENTRIC NOTCH STRENGTH AS A FUNCTION OF TESTING TEMPERATURE FOR VARIOUS LOCATIONS FROM THE WELD CENTERLINE (VALUES TAKEN FROM AVERAGE CURVES).

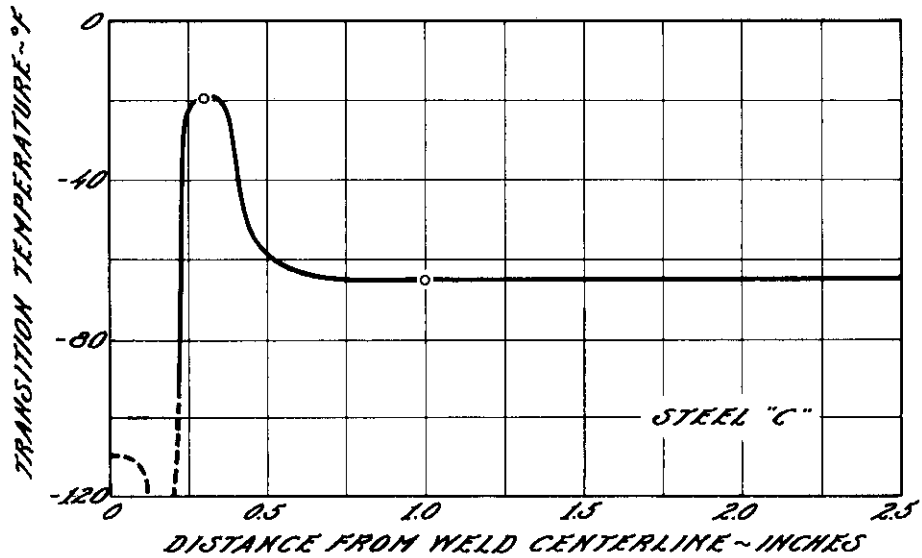

FIG. 19: VARIATION OF TRANSITION TEMPERATURE WITH DISTANCE FROM THE WELD CENTERLINE FOR AS WELDED "C" STEEL PLATE (DERIVED FROM FIG. 18).