

SSC-252

252

**THIRD DECADE OF RESEARCH UNDER
THE SHIP STRUCTURE COMMITTEE**

This document has been approved for
public release and sale; its
distribution is unlimited.

SHIP STRUCTURE COMMITTEE

1976

SHIP STRUCTURE COMMITTEE

AN INTERAGENCY ADVISORY
COMMITTEE DEDICATED TO IMPROVING
THE STRUCTURE OF SHIPS

MEMBER AGENCIES

United States Coast Guard
Naval Sea Systems Command
Military Sealift Command
Maritime Administration
American Bureau of Shipping

ADDRESS CORRESPONDENCE TO:
Secretary
Ship Structure Committee
U.S. Coast Guard Headquarters
Washington, D.C. 20390

SSC-252

16 JAN 1976

The attached report "Third Decade of Research Under the Ship Structure Committee" summarizes the accomplishments of the Ship Structure Committee for the past ten years. It continues the historical documentation cited in "Twenty Years of Research Under the Ship Structure Committee" (SSC-182) that began with the final report of the Ship Structure Committee's predecessor, the Board to Investigate the Design and Methods of Construction of Welded Steel Merchant Vessels.

The Ship Structure Committee appreciates the courtesy of the Society of Naval Architects and Marine Engineers to publish this report as a separate document while it will still appear as a paper in the board transactions of the October 6 - 8, 1975 "Ship Structure Symposium '75" sponsored jointly by the Society of Naval Architects and Marine Engineers and the Ship Structure Committee.

The Society of Naval Architects and Marine Engineers, 130 West 42nd Street, New York, N.Y. 10004, should be contacted for a complete list of symposium transactions.

W. M. Benkert

W. M. Benkert
Rear Admiral, U.S. Coast Guard
Chairman, Ship Structure Committee

SSC-252

Special Report

on

THIRD DECADE OF RESEARCH UNDER THE
SHIP STRUCTURE COMMITTEE

by

LCDR E. A. Chazal, Jr., USCG,
U.S. Coast Guard, Washington, D.C.
Prof. J. E. Goldberg, Purdue University
Lafayette, IN
J. J. Nachtsheim, Maritime Administration,
Washington, D.C.
R. W. Rumke, National Academy of Sciences,
Washington, D.C.
A. B. Stavovy, Naval Ship Research and
Development Center, Washington, D.C.

*This document has been approved for
public release and sale; its
distribution is unlimited.*

U. S. Coast Guard Headquarters
Washington, D.C.

1976

ABSTRACT

Results of the research efforts of the Ship Structure Committee from the past decade are presented. Particular attention is given to the contributions made by this research to achieving the broad goals of the Ship Structure Committee: Design Methods, Verifications, Load Criteria, Materials Criteria, Fabrication Advanced Concepts, Information Retrieval and Dissemination, and the Teaching of Naval Architecture.

INTRODUCTION

The Ship Structure Committee is an interagency government body whose long-term objective is to improve the structures of ships. Previous papers dealing with the progress of the Ship Structure Committee's research program describe the early goals of the effort. (1) (2)^{/a} In the paper by Wright, Jonassen, and Acker in 1952 (1) an excellent summary on the subject of the Committee's goals was given:

"Since it is not known whether present requirements and practices are sufficient to prevent cracking, a large portion of the research program sponsored by the Ship Structure Committee will continue to be directed toward solution of the ship fracture problem. Once this problem is clearly solved, the research activity of the Ship Structure Committee is expected to be directed toward improving the general structural effectiveness of the ship's hull and in reducing building and operating costs."

In commenting on that paper regarding anticipated work for the future, the Secretary of Treasury, The Honorable John W. Snyder, said:

^{/a} Bracketed numbers indicate references listed at the end of the paper.

"This program holds great promise when we consider the recognized value of maintaining an adequate and efficient merchant marine. Likewise, the design and construction of such vessels must contribute to the never-ending effort of enhancing the safety of lives at sea."

These statements in general accurately represent the current objectives of the Ship Structure Committee and an active, comprehensive research program continues.

The early efforts of the Ship Structure Committee concentrated on ship fracture and the ship structures community eventually had cause to believe that this problem was solved. Many subsequent research efforts were directed into other areas to try to keep technology ahead of practice; or, as is so often the actual case, to try to keep technology as close behind practice as possible. Thus, the community was just as surprised when the large integrated tug/barge *M.V. MARTHA R. INGRAM* broke in two in 1972, as it had been when the *S. S. SCHENECTADY* broke in two while lying at the builder's dock in 1943. This was dramatic proof that a definite need still existed for continued ship fracture work and that research should continue in the structures field so long as new practices in ship design, construction and operation continue to manifest themselves. Figure (1).

Continued research is needed to be prepared for such events as indicated above and also to anticipate the ship building and design requirements for the future. The significance of continued research in reducing shipbuilding costs, for example, can be seen if one considers constructing the very large tankers of today with the technology of as little as fifteen years ago. A 390,000 dwt tanker built to 1957 ABS rules would require a deck and bottom shell plating thickness of 3-3/4 inches of mild steel; today's rules require a 1-inch thickness of higher strength steel. The

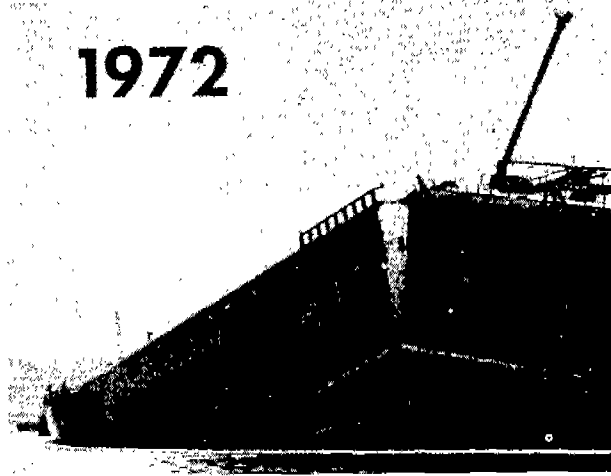

Fig. 1 - Without Warning S.S. SCHENECTADY and Barge IOS 3301 of the Integrated Tug-Barge M.V. MARTHA R. INGRAM.

MANHATTAN built in 1957 with 1-1/2 inch plating and 1-1/2 inch doublers would, under today's Rules, require only 1-1/4 inch plating, on the average.

Today, as this interagency research effort continues in all facets of ship structure, its activity is updated every two years as required by government regulations. At that time the objectives of the Committee are reassessed. The present specific objective of the Committee in its effort to improve the structures of ships is:

"The objective of the Ship Structure Committee research and development program is to provide information which will assist the U.S. shipbuilding industry in designing and building safer, more cost effective, and more easily maintained ship structures by exploiting existing and potential competitive advantage through the advancement of technology."

In addition to this continued government endorsement of the Committee's activities the agencies involved have continued to provide financial support despite ever increasing pressure to cut existing programs of long standing. This financial support has continued because the results of this research have been effective; they have saved money; they have reduced losses; and they have enhanced the safety of life and property at sea. In addition to being effective, research carried out in this manner is very economical. This may well be the best research bargain any one of the participating agencies sponsor. First, they get the benefit of one another's financial contributions, a significant leverage factor of itself and, second, there is a wealth of technological talent which is contributed to the program at no direct cost whatsoever. The depth and breadth of this talent cannot be

matched anywhere.

Participants include many members of the Hull Structure Committee of the Society of Naval Architects and Marine Engineers, members of the Ship Structure Subcommittee, the Ship Research Committee, the liaison agencies, the researchers themselves, and particularly the Ship Structure Committee.

In 1967, a paper was presented at the SNAME Annual Fall meeting, giving the salient results of the first two decades of Ship Structure Committee research. The research efforts of the Ship Structure Committee in the past decade are presented in the next section of this paper. When taken together with the "20-year paper" (2) the full 30-year record of the Committee's achievements can be reviewed.

THE SHIP STRUCTURE COMMITTEE'S RESEARCH PROGRAM

One of the goals stated in 1967 was to develop the basis for a rational structural design which would permit the design of faster, larger and more complex ships than our experience oriented design base would then permit. A rational approach requires the characterization of the real loads that a ship experiences in service so design loads can be specified that more truly reflect the real world. It is then necessary to apply these loads to mathematical models of the ship that respond in a fashion more akin to the real ship than present practice achieves. Finally, the design detail problems of fracture avoidance, margins of safety, and economic and effective distribution of structure must be solved. To achieve this rational approach, the Ship Structure Committee has adopted a series of goals to pursue in meeting the broad objectives discussed in the Introduction. These goals are flexible and can be modified to meet the existing needs of the

maritime industry. The present goals are:

1. Design Methods: To develop improved design/analysis methods both by improving existing procedures and developing new techniques.
2. Verification: To verify design methods by coordinated full-scale testing, model testing, and theoretical analysis.
3. Load Criteria: To develop improved load criteria.
4. Materials Criteria: To develop improved criteria for the application of ship building materials systems and to establish methods for material selection within the design process.
5. Fabrication: To develop improved techniques and guidance for ship erection and construction, including improved test techniques.
6. Advanced Concepts: To identify structural problems of advanced ship design concepts and to address solutions to these problems.
7. Information Retrieval and Dissemination: To improve the means of retrieving information and disseminating the results of research to those concerned with modern ship hull structural problems.
8. Education: To promote the teaching of structural naval architecture in the United States.

The Ship Structure Committee's research program which is responsive to these goals will be presented in three major areas: Loads, Structural Response, and Special Application. Any one project in the program may easily contribute to more than one goal.

The first technological area, Loads, includes discussions of data from ships in service, model testing, and theoretical studies; how these methods of determining loads are correlated with each other and used for lifetime loading predictions of ships in service; and considerations of cyclic loading on ship structure producing fatigue.

The second area, Structural Response, includes discussions on hull flexibility, ultimate strength of the hull girder, fracture, and problems of fabrication and quality control.

The final area, Special Applications, includes discussions of material

applications such as high-strength steel, aluminum, glass-reinforced plastics; special vessels, such as catamarans, liquefied natural gas carriers, independent tanks; and design techniques using specialized forms of construction.

Loads

Most Naval Architects are keenly aware of the empirical foundation for much of our ship structure technology through the middle 1950s. Past satisfactory performance of similar ships in similar service provided the guide in selecting scantlings. The test of historical acceptability, whether by designers' files, classification society rules, or other sources, could only be used as long as the governing parameters remained essentially unchanged. The painstakingly accumulated empirical data was not satisfactory for developing scantling standards for the larger vessels which came on the scene in the late 1950s. The practical considerations of conducting a rigorous analysis of the complex ship structure were also limiting. However, the advent of the modern high-speed computer provided a tool that could be used efficiently in the processing of the large volumes of data required for the analysis. The potential of being able even to contemplate such analysis pointed up the fact that better, more rigorous definitions of the loading patterns of ships would have to be developed and understood.

In order to achieve a better understanding of loads as they are applied to the ships' structure, investigations have been carried out to obtain data from operating ships and model tests. In addition, preliminary correlation studies have been made with scale models and full-scale results as compared with theory and computer simulations.

Data from ships in service. The earliest Ship Structure Committee effort in achieving a better understanding of the loads experienced by ships in service was the long-term project "Ship Response Statistics." Initiated in 1959, this project obtained statistical records of longitudinal bending moments experienced by various types of ships operating on different trade routes. Emphasis was placed on extreme bending moment values.

Although substantial results were published before 1967 and commented on in Ship Structure Committee Report SSC-

182, (1) a brief recap shows that four ships were instrumented. The first ship was the *HOOSIER STATE*. Later, the *WOLVERINE STATE*, a sister ship, was instrumented to verify that the measurements taken on one of a class would be similar for all ships of the class. The *MORMACSAN*, with machinery amidships, was instrumented in order to determine the effect of machinery location. Finally, since the first three ships all plied Atlantic trade routes, the *CALIFORNIA BEAR*, which operated in the Pacific between the western United States and the Orient, was instrumented and reported in SSC-181. Data condensations from eleven voyages of the *WOLVERINE STATE* and five voyages of the *MORMACSAN* are for a total of 6,528 hours of operation for both ships. The maximum peak-to-trough stresses for each sea state are shown in Figures (2) and (3), where each dot corresponds to the reduced data from a half-hour representative record of four hours of ship operation and each x represents the calculated average values for a given sea state. An examination of these figures show that even in a high sea state corresponding to 11 on the Beaufort wind scale, relatively low peak-to-trough stresses of about 7 Kpsi were recorded. A plot of all the averaged maximum peak-to-trough stresses versus sea state are shown in Figure (4). This is an averaged plot of all voyages and includes data from different routes and seasons for each ship. The variation because of route and season is indicated by Figure (5) for the *WOLVERINE STATE* only.

The results of the instrumentation program on the four-ship series led in 1968 to the design and installation of a somewhat expanded instrumentation package on the containership *BOSTON*, a converted near-sister ship to the *WOLVERINE STATE*. Additionally, acceleration and motion data were recorded. An effort was made to install the instrumentation in locations to provide similar data to the *WOLVERINE STATE* (SSC-212, 214). Figure (6) compares the maximum peak-to-trough stresses versus sea state between the *WOLVERINE STATE* and *BOSTON* and shows the effects of large deck openings and reduced section modulus.

One difficulty encountered in this program was in obtaining reliable sea state information. At first, only human observations were used. Later in

the program, an attempt was made to obtain better data using a Tucker wave meter. The comparison was poor, and the need for an acceptably precise, yet reliable, recorder of the sea surface profile became pressing.

Expendable wave buoys were used in an attempt to gather the sea surface information in a more definitive fashion. Although some sea state data were collected, the speed of the ship permitted only 20 minutes of recording before signal strength was lost from the deployed buoy. This was costly and only a few runs were actually made.

In another attempt to obtain reliable sea surface data a microwave radar has been developed and placed in use on the highspeed SL-7 containership *SEA-LAND McLEAN*. However, since the radar is mounted on the moving ship, the problem of reducing the raw data from the radar is not a trivial task. It is possible that the supporting data recorded to provide the supplementary information such as accelerations to describe the ship motions may not be the best for the intended purpose, but it is apparent that a reliable recording device is available for recording sea surface information and long-term records. At the same time, records were also made using Tucker wave meter and human observation so that correlations, if they are possible, can be obtained. This would possibly improve the quality of the data developed in earlier programs. A current project is attempting to reduce the data from the radar and develop correlations with Tucker meter and human observation.

The most comprehensive coordinated surface ship load and response analysis research program ever undertaken is the multi-element program on the SL-7 containerships. This jointly-funded program, sponsored by the Ship Structure Committee, the American Bureau of Shipping, and Sea-Land Services, Inc., really should be viewed as a natural continuation of the earlier Ship Structure Committee efforts in defining ship load and response analysis as it contains the following elements:

1. Full-scale measurements onboard the *SEA-LAND McLEAN* and the reduction and analysis of that data. A complete discussion of the instrumentation package was reported in SSC-238. Additional reports will be forthcoming.

2. Structural model tests of the SL-7 sponsored by the American Bureau of Shipping and conducted at the University of California at Berkeley. (To be published).

3. Finite element analysis of the

(1) SSC Reports issued after SSC-172 are listed in Appendix 1. A list of reports issued prior to SSC-182 is included in that report and in reference 2.

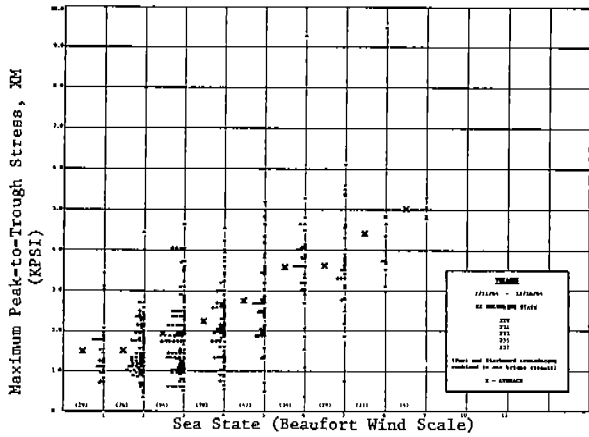

Fig. 2 - Maximum Peak-to-Trough Stress vs. Sea State *S.S. WOLVERINE STATE*.

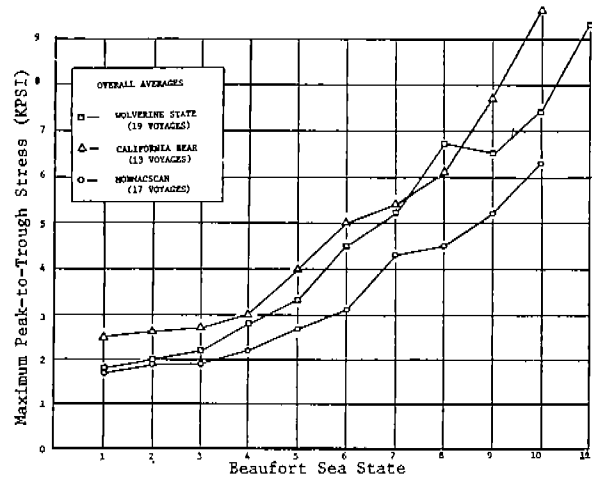

Fig. 4 - Average Plot of Maximum Peak-to-Trough Stress vs. Beaufort Sea State, 3 Ships.

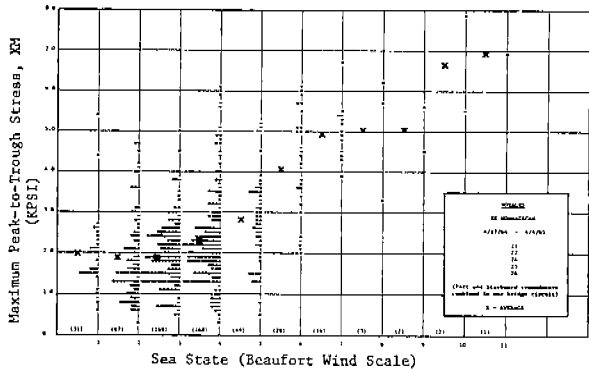

Fig. 3 - Maximum Peak-to-Trough Stress vs. Sea State *S. S. MORMACSCAN*.

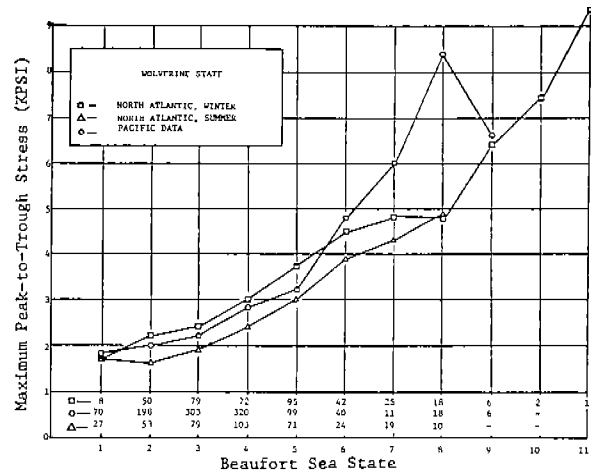

Fig. 5 - Average Plot of Maximum Peak-to-Trough Stress vs. Beaufort Sea State, *S.S. WOLVERINE STATE*

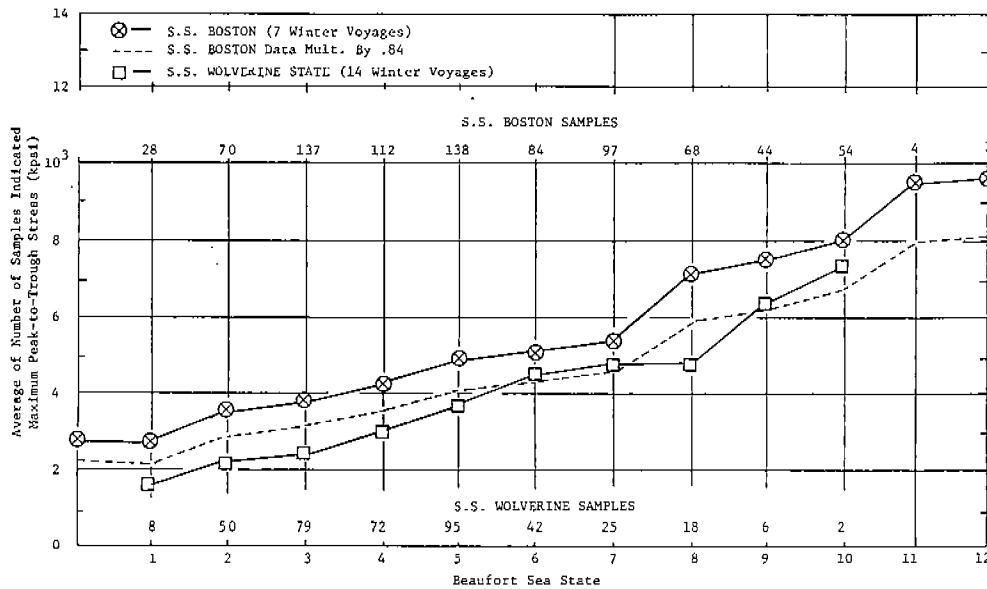

Fig. 6 - Vertical Longitudinal Bending Stress Comparison - *S.S. BOSTON* and *S.S. WOLVERINE STATE*.

SL-7 by the American Bureau of Shipping using the DAISY program (SSC-243).

4. Towing tank model tests to determine bending and shear loads (SSC-239).

5. Theoretical hydrodynamic analysis using the SSC-sponsored ship response program SCORES (SSC-246).

In order to develop the program, it was necessary to review past efforts and to select the most promising approaches for both collecting the data and then developing the plan to use that data. The development of the overall program will soon be published as a separate report. Individual components are examined in greater detail in the various sections of this paper. The reader is asked to keep in mind the overall coordination of the program as he reads a description of some single project. The overall goal is to either develop or provide supporting evidence for rational design methods for ships.

The Ship Structure Committee ship instrumentation projects have been in the forefront in developing full-scale shipboard instrumentation technology. This has been put to use by other organizations, including the sponsors of the Ship Structure Committee in independent efforts of their own. The tanker loads program of the American Bureau of Shipping, Coast Guard-supported studies on Great Lakes ore carriers, and a proposed joint U.S.A.-U.S.S.R. ship loads response program to be administered by the Maritime Administration have benefited from the technology developed under the auspices of the Ship Structure Committee.

The Ship Structure Committee recognized the need not only for developing a better understanding of the various loading phenomena, but also for at least developing some insight into the types of damage sustained by ships regardless of load source. A structural damage survey of ships in service, conducted in 1970, describes ship structural failures by type, frequency, and location. The hope was to improve structural reliability by discerning any meaningful trend and then concentrating some effort on a cure. The results are published as SSC-220. In developing the survey, only post-1955 ships were examined so that the results would not be biased by failures that could have been influenced by the brittle fractures of the steels used prior to that time. Casualty data were obtained from the U.S. Coast Guard, Maritime Administration, and Military Sealift Command files. Often American Bureau of Shipping, U.S. Salvage Association, and Salvage Association of London reports were part of the agency files and provided much of the detailed information. The limitations of each reporting system were considered,

and a suitable format was selected for uniformly collecting the data. In the end, 824 cases from 146 ships over the 15-year period were considered. The results, indicated that the cost of damage was not available in the records, and frequency alone is not a reliable indicator of cost. The survey did point out the need for a uniform system for collecting failure data. The Coast Guard undertook the development of this system with its Merchant Vessel Inspection Information System.

Data from Model Testing. The availability of full-scale results from the ship instrumentation programs has made it possible to explore more fully the strengths and weaknesses of model testing in developing adequate designs.

In 1960, the Ship Structure Committee initiated a study using ship-model tests to investigate hull bending moments developed in regular and irregular seas and with variation in loading distributions. The results of these earlier studies involving a Mariner class cargo ship (with variation in freeboard), a destroyer, and a tanker were reported in SSC-155, 156, and 157. A principal conclusion of these early studies was that no dramatic upper limit of wave bending moments at amidships should be expected as ratio of wave height to wave length increases to about 1:9. This added credence to determining design wave bending moments on the basis of statistical analysis of ocean waves. The conclusion was valid within practical operational and design limits but was applicable only for midship bending moments. The next phase of study (SSC-163) examined longitudinal distribution of bending moments in regular waves of extreme steepness. The results for a Mariner class cargo ship showed that designers' practice of concentrating on midship bending moment in design studies is justified because the maximum moment occurred in the midship half length.

The Mariner model was also tested in high irregular waves. Wave and bending moment energy spectra were computed (from the time history of wave bending moments and wave elevations) and used to derive equivalent regular-wave bending moment "response operators". These were shown to be in reasonable agreement with response results obtained from model tests in regular waves. This agreement reinforced confidence in the procedure of using "response operators" from regular wave tests to predict bending moment response of a ship in a real seaway having a known energy spectrum.

Having achieved the regular-to-irregular seas model data correlation,

the next phase was to determine satisfactory correlation of model and full-scale ship bending moment responses. SSC-201 and 202 report the results of the model wave bending moment for the *WOLVERINE STATE* and the *CALIFORNIA BEAR* that are in the model-ship correlation discussed in the section on Correlation Studies. The model data indicated that peak moments tend to occur at a constant value of wave length/ship length and that peak vertical moment occurs in head seas, while peak lateral moment occurs in bow or quartering seas.

As the full-scale studies spread to the converted cargo to containership *BOSTON*, plans were being made to model test the *BOSTON* to not only develop mid-ship bending moments, but more specifically, to determine torsional moments and lateral shear loads. However, the advent of the SL-7 containership program prompted a dramatic change in modeling from the 522 foot converted transversely-framed cargo ship to the 946 foot longitudinally-framed containership. The model tests were carried out in advance of the full-scale test program (SSC-239). This test was conducted while the full-scale SL-7 was still under construction, so owner anticipated loading conditions had to be developed. The magnitudes and trends for both vertical and lateral moments fall very much in line with prior tests. The lateral and torsional reactions are related more directly to roll amplitude than to rudder deflection. Additionally, the highest of those values were obtained in a wave of about one-third of the ship length.

Data from Theoretical Studies. In 1966 a program was begun to assemble the various mathematical equations that would adequately describe the structural response of a ship in a seaway. Of particular interest was the development of computer simulations in order to compress the time element in obtaining statistical data. The emphasis was to be on determination of hull girder bending moment response of a ship for given wave conditions. Consideration was to be given to both slowly varying bending moments induced by waves as well as to the slam-induced bending moments.

The first phase of this work was devoted to a survey of the mathematical models available with emphasis on the slowly varying wave-induced bending moment. This emphasis was placed in order to compare results with the *WOLVERINE STATE* data. In SSC-193 theoretical predictions were made for the wave-induced bending moment and slam-induced moments. Ship motions were determined using a "strip theory" approach. (3) The equations for the wave-induced bending moment and slam-induced bending

moment were developed. However, it was determined that spectral analysis would be required for the latter and this was then held in abeyance. Figure (7) shows a typical comparison of theoretical wave bending values computed by hand calculation with the experimental data from the 1/96-scale model of the *WOLVERINE STATE*.

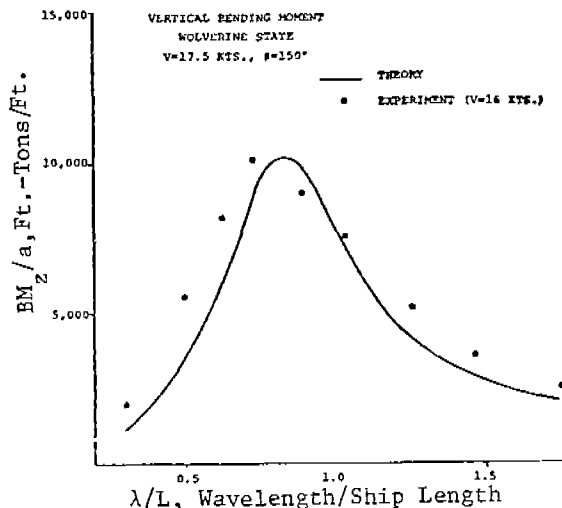

Fig. 7 - Comparison of Theory and Experiment, Vertical Bending Moment, $\beta=150^\circ$.

The second phase of the effort converted the equations described in SSC-193 into a suitable computer program. The results are reported in SSC-197 and include comparisons with model tests of the *WOLVERINE STATE* and the *USS ESSEX*. Typical computer results for wave-induced bending moment are shown in Figure (8). The computed values have good agreement with available experimental data except for the shorter wave lengths where the ratio of wave length to ship length was equal to or less than .5, and strip theory assumptions are not valid. Allowing for the pre-

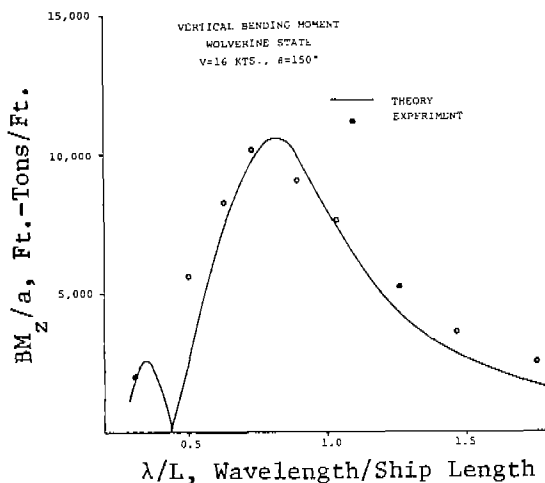

Fig. 8 - Comparison of Theory and Experiment, Vertical Bending Moment, $\beta=150^\circ$.

liminary nature of the work, the capabilities of existing computers were satisfactory for the computation.

The third phase of this effort was the development of a simulation program. These efforts were reported in SSC-229 and 230, which describe both the analysis techniques and results. The analytical method developed into a computer program called SCORES provides for determination of conventional ship motions and the wave-induced moments in a seaway. Modifications using spreading factors were developed to provide satisfactory results for short-crested seas. The ship can be mathematically modeled on any heading in either regular or irregular seas for both long- and short-crested waves. Strip theory is used and a Lewis-form shape assumed for each hull cross-section in order to calculate hydrodynamic added mass and damping forces in vertical, lateral, and rolling oscillation modes. The coupled equations of motion are linear and superposition is used for the statistical response in irregular seas.

The three primary hull loadings, vertical and lateral bending, and torsional moments, in addition to shear forces, can be determined at any point along the length. The program, when run for a ship at two speeds, seven headings, twenty-one wave frequencies, and five sea states, takes only 50 seconds of processing time on a CDC 6600 computer.

The SCORES program has received wide acceptance. It has been modified since the original version was published in the SSC series. Typical results compared with model results for the *WOLVERINE STATE* are shown in Figure (9).

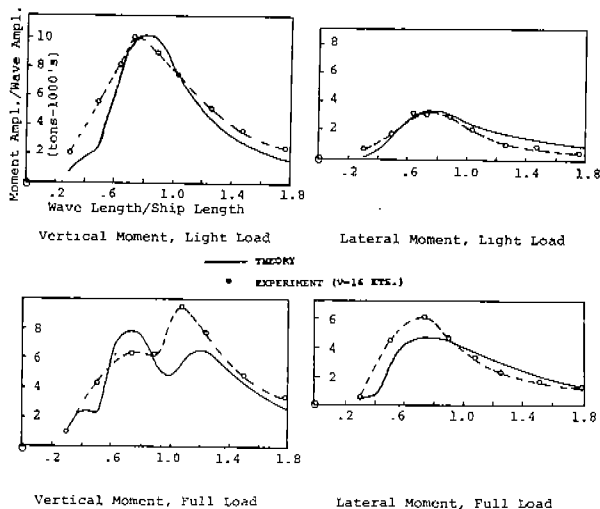

Fig. 9 - Midship Wave Bending Moments on *WOLVERINE STATE*, $\beta = 150^\circ$.

Bow flare slamming, bottom impact slamming, and springing were further examined in SSC-231. Results were obtained using a large high-speed digital computer at computation rates faster than the real-time rate of the actual ship motion. The analysis was primarily developed as a demonstration model; consideration of only head seas requires that some extensions be made prior to developing a truly general computational procedure.

In conjunction with the most recent instrumentation program on the SL-7 container ship, an analytical study (SSC-246) using SCORES was made for loading conditions similar to those model tested (SSC-239).

A study is underway to use the data developed in SSC-239 and SSC-246 with the ultimate purpose of determining the capabilities of both test methods for prediction purposes. Comparisons are to be made for all similar operating conditions and to include roll, heave, pitch, lateral shear, and lateral, vertical, and torsional bending moment data. Ultimately a comparison will be made with the full-scale data collected from the *SEA-LAND McLEAN*.

Correlation and Analysis Projects in Lifetime Loading of Ships. In 1966, test results, both full-scale and model, were assembled and analyzed to develop prediction methods for the loading moment history that a ship will experience in its lifetime. While the analysis of ship stress data and extrapolation of long-term statistical trends reported in SSC-196 showed several techniques that can be applied to the problem, it also pointed out a basic problem. The direct application of full-scale bending moment data to the design of ships is only useful for very similar ships. The collection of full-scale data would also be an expensive task for such limited return. However, methods of predicting long-term distribution of wave bending moment from model tests and ocean wave spectra have been developed and validated by collecting full-scale data and performing model tests on the same ships in equivalent "sea" condition. The coordination of data also permitted evaluation of the theoretical (computer-oriented) methods and thus provides at least a few points for establishing the validity of the technique. The theoretical computations are generalized with some limitations over a wide range of potential ship forms.

An improved analysis method (for examining the raw data of earlier instrumentation projects) was developed and reported in SSC-236 and 237. The rapid expansion of computer technology in the late 1960s made digital process-

ing using high-speed computers both practical and desirable. Earlier analysis had been accomplished utilizing a specialized instrument called a probability analyzer. The new technique permits conversion of analog to digital tape for information storage at the same time a limited analysis is being made of the content of the record. The purpose of the analysis is to examine the record and extract information needed for the longer term statistical studies. Table I lists the data that have been digitized for each 30-minute recorded interval as well as for the entire voyage.

The results of the analysis of full-scale data for the *WOLVERINE STATE*, *HOOSIER STATE*, *MORMACSAN*, and *CALIFORNIA BEAR* are presented in the form of histograms and cumulative distributions. SSC-196 provides predictions of extreme bending moments over a ship life, which can be obtained by either integrating the RMS stress data from individual stress records or using the extreme values obtained in each record. The preliminary investigation showed that although either method would produce a similar trend, unexplained differences existed.

Augmenting the SL-7 program is an ongoing project that records extreme stress gauges on the *SEA-LAND McLEAN* and seven sister ships. This will continue for a period of five years. The records produced show the extreme stress variations over a four-hour interval. The devices have operated reliably since installation. This adjunct project was initiated on the basis of results obtained through a project on Ship Statistics Analysis and reported in SSC-196, 233, and 234.

In SSC-233 a comparison is made between model and full-scale predictions of long-term wave-induced bending moment trends for the *WOLVERINE STATE* and the *CALIFORNIA BEAR*. Two types of information are needed to make such predictions:

1. Wave data for different sea states and relationships between wave heights and wind speeds.

2. Model response amplitude operators as a function of ship loading condition, speed, and heading.

In this analysis, good agreement with extrapolated full-scale results was obtained for the *WOLVERINE STATE* in North Atlantic service. Only fair agreement was possible for the *CALIFORNIA BEAR* in North Pacific service, probably because of the lack of ocean data for this region. In general, the results indicate that predictions of

TABLE I - Digitized Data Included for Each Interval and Each Voyage.

INTERVAL IDENTIFICATION AND LOGBOOK DATA:

FM ANALOG TAPE REFERENCE
 LOGBOOK INDEX NUMBER
 INTERVAL NUMBER
 DATE
 TIME (GREENWICH MEAN)
 LATITUDE PREVIOUS NOON
 LONGITUDE PREVIOUS NOON
 COURSE (DEGREES)
 SPEED (AVG. PAST 4 HRS. IN KNOTS)
 ENGINE RPM
 BEAUFORT SEA STATE
 RELATIVE WIND DIRECTION (DEGREES PORT OR STBD.)
 RELATIVE WIND VELOCITY (KNOTS)
 TRUE WIND VELOCITY (KNOTS)
 RELATIVE WAVE DIRECTION (DEGREES PORT OR STBD.)
 WAVE HEIGHT (FEET)
 WAVE PERIOD (SECONDS)
 WAVE LENGTH (FEET)
 RELATIVE SWELL DIRECTION (DEGREES PORT OR STBD.)
 SWELL HEIGHT (FEET)
 SWELL LENGTH (FEET)
 BAROMETER READING (IN. HG OR MILLIBARS)
 SEA TEMPERATURE (DEG. F)
 AIR TEMPERATURE (DEG. F)
 WEATHER CODE
 COMMENT CODE (SLAMMING, HEAVY GOING, ETC.)

INTERVAL SUMMARY:

NUMBER OF WAVE-INDUCED PEAK-TO-TROUGHS
 NUMBER OF BURSTS OF FIRST-MODE
 WAVE-INDUCED RMS STRESS
 MAXIMUM WAVE-INDUCED PEAK-TO-TROUGH STRESS
 MAXIMUM FIRST-CYCLE FIRST-MODE PEAK-TO-TROUGH STRESS
 MEAN VALUE STRESS (RELATIVE TO FIRST INTERVAL IN PASS)
 TABULATION OF ALL WAVE-INDUCED PEAK-TO-TROUGH STRESSES

DIGITAL RECORD OF INTERVAL

DIGITIZED ANALOG DATA FOR INTERVAL USING SAMPLING RATE OF 10 PER SECOND (12,000 DATA POINTS)

VOYAGE IDENTIFICATION:

SHIP NAME
 OWNER'S VOYAGE NUMBER
 DATE VOYAGE START
 DATE VOYAGE END
 ROUTE (FROM/TO)
 ROUTE CODE
 FM TAPE REFERENCES
 SHIP CALIBRATION FACTOR
 LOCATION OF ACTIVE GAGES (PORT/STBD)
 LOCATION OF ACTIVE GAGES (FORE/AFT POSITION)
 DRAFT - FWD
 DRAFT - MID
 DRAFT - AFT

VOYAGE SUMMARY:

NUMBER OF WAVE-INDUCED (W.I.) PEAK-TO-TROUGHS
 NUMBER OF BURSTS OF FIRST MODE
 MAXIMUM WAVE-INDUCED RMS STRESS
 MAXIMUM WAVE-INDUCED PEAK-TO-TROUGH STRESS
 MAXIMUM FIRST-CYCLE FIRST-MODE PEAK-TO-TROUGH STRESS
 MAXIMUM EXCURSION OF MEAN VALUE

long-term trends on the basis of model tests are satisfactory where adequate ocean wave spectral data exist.

The development of a rational procedure for determining the loads which a ship's hull must withstand is a primary goal of the Ship Structure Committee's program. An effort to synthesize the results of the diverse projects and to collect in one location the philosophy and criteria that will be needed to implement the rational design procedures is contained in SSC-240.

Concepts of rational design involve the complete determination of all loads on the basis of scientific rather than empirical procedures. The approach is perhaps best characterized as being the "capability" of structure to meet the "demands" of the potential loading. One consequence of such a design approach is that if the structural response can be determined and that if all loads are considered, then large factors of safety or ignorance can be avoided. The design criteria developed was exercised on the basis of an existing vessel, the *WOLVERINE STATE*. It was found that section modulus requirements could be reduced by about 10%, provided the rational design procedures were followed, rather than the existing classification rules. This result changes somewhat if nuisance damage is considered in overall economic cost. One of the conclusions of SSC-240 was that cyclic loading should be given a greater emphasis because it does lead to nuisance cracking. If unchecked, these cracks could contribute to catastrophic fracture.

Cyclic Loading. Fatigue has not been given adequate attention in the field of surface ship structures. It is generally considered to be an intermediate problem that can lead to the growth of a flaw to the critical size needed to initiate fracture. It has economic and environmental consequences because repairs must be made and spillage can occur.

SSC-188 contains a feasibility study of the influence of repeated loadings on the low-temperature fracture behavior of one ship steel, ABS-C. Two other steels, HY-80 and a rimmed steel, were introduced for comparison purposes. The specimens were tested in a 200,000-lb. lever-type fatigue machine. In general, the results show that the fracture behavior of the weldments is influenced by the loading history. Except for one test, the fracture stress for the notched and welded wide-plates were greater than the loading stresses.

SSC-251 shows that pre-existing flaws may grow by fatigue, corrosion fatigue, stress corrosion, and other

potential mechanisms exclusive of brittle fracture. This can occur in high-strength ship steels and weldments, when subjected to loading and environmental conditions of ship service. The results indicate that insofar as crack initiation and subcritical crack propagation are concerned, there is no benefit or penalty associated with yield strength. However, high-strength, low-alloy steels may possess enhanced resistance to withstand overload cycles.

Structural Response

The capability of determining how a structure will react to various loading situations is very important. This is one of the fundamental elements of the Ship Structure Committee's program in order to improve the methods of design and selection of materials for design. Ships are extremely complex structures operating in an environment that is difficult to define. Some of the idealizations that must be made in order to achieve tractable solutions might seem to be overly simplistic to the uninitiated. The advent of computers has made the handling of large amounts of numbers possible, but for ship size problems, even stress analysis is a costly process. After obtaining the stress, the designer must still weigh it against many potential failure modes. The absolute value of stress may not be as critical as its cyclical nature or the stress distribution present in the structure. The importance of understanding the loads on the structure is reaffirmed. The fully rational design procedure that a naval architect can apply to any general concept remains an elusive goal. Progress has been made, however, and the knowledge developed for parts of the puzzle contribute substantially to the ability to produce effective ship structure.

Hull Flexibility. The application of an impulsive load to the ship produces a dynamic response from the hull girder. The effects of varying stiffness of that girder were examined in SSC-186. The hull was modeled as a Timoshenko beam and the equations of motion were solved using the finite difference method. Two computer programs were developed. One solves the equations using an explicit analog for the dynamic equations. This method is more efficient for short duration impulses. The second program uses an implicit analog for the dynamic equations. This technique is superior for longer impulse duration. In this study, the required information included hull geometry, material characteristics, and description of the hydrodynamic loading. The results include response of the structure in the elastic modes and the maximum bending moment amidships.

Comparisons were made between a standard cargo ship, *WOLVERINE STATE*, and equivalent ships of reduced stiffness. The limited analyses indicated that for a unit impulse, greater flexibility reduced the response from slam loads.

The full-scale data collection program on the *WOLVERINE STATE* included information which could be used in studying the slamming problem. In order to aid in utilizing that data, a state of the art review on slamming was undertaken and reported in 1970 as SSC-208. The report summarized the available theory and prior test results and concluded that:

1. Slam pulse width varies from .05 milliseconds to 20 or 30 milliseconds.
2. Peak pressures range from 300 to 1000 psi.
3. Pressure rise times that had been measured varied from 50 to several hundred milliseconds. This value was influenced by the response of the instrumentation system.

The instrumentation on the *WOLVERINE STATE* was capable of measuring slamming pressures on the forward bottom, vertical accelerations, and midship stresses. The project was directed more toward midship bending response and predicting incidence of slamming. It did not provide for all the information needed to describe fully the phenomena.

SSC-210 reports that the instrumentation on the *WOLVERINE STATE* was expanded to include the pressure transducers and accelerometers. Experience indicated that slamming occurred only at sea states corresponding to a Beaufort 5 or higher and only when relative headings are within 30° of head seas. However, since no slamming damage occurred during this period, the nature of plate deforming pressures is still unknown.

Although slamming is an important consideration in evaluating hull flexibility, vibratory response must also be considered. The effects of girder stiffness on vibratory response were examined in SSC-249. An evaluation was made of various commercially available computer programs for obtaining hull vibratory analyses. The hydrodynamic factors were considered and an idealization was developed to permit the use of one of the available analysis programs.

A parametric analysis was made by varying hull stiffness and observing the trends in dynamic responses due to propeller, slam, and wave excitations. The vessels analyzed were the 712 foot Great Lakes ore carrier *STR. EDWARD L. RYERSON*, a 1085 foot tank ship, and a 544 foot general cargo ship *SS MICHIGAN*.

The trends indicate in general that hull stiffness does not affect response caused by propeller-induced vibrations. The slam-induced vibrations increase with increases in stiffness. Only the tanker and Great Lakes ore carrier were prone to the wave-induced vibration, and in this case, increasing stiffness limited the response. This study was limited to vertical vibration of the main hull. Lateral vibration should also be considered. An extensive literature search was made on vibration in general, however, very little on wave-induced vibration was found. The results of this search are published as a bibliography in SSC-250.

Ultimate Strength of the Hull Girder. The principal loads of the many to which the ship is subjected include longitudinal compression caused by primary vertical bending, athwartship compression caused by pressure on the side shell, and the normal pressure from the sea. There has been a need for data to provide the basis for design of the primary structure of the hull girder, especially since newer designs have departed substantially at least in size from past practice. The thinner sections and use of high-strength steels in supertankers is but one example. Better understanding of the mechanism of ultimate collapse might also reduce the need for large factors of safety imposed because of a lack of knowledge.

The complexity of ship structures, the involved nature of the ship loads, and the difficulties and costs in obtaining full-scale ship ultimate strength data prompted the development of a large-scale or component test plan. SSC-194 presented an evaluation of the state of knowledge as of 1969 and developed an experimental model which could obtain significant data at a low cost. The model to be tested in compression would be steel boxes less than a foot long.

Using pressure or vacuum sources, a normal pressure could be induced on the model. The boxes were strain gauged and a test series for both uniaxial and biaxial compression was prepared and carried out. The results indicated:

1. A large reduction in longitudinal strength with the application of transverse loading for a ratio of plate width (b) to plate thickness (t) of $b/t=50$ or less. The failure mode appeared to be plastic biaxial buckling. For larger b/t ratios of 70 and 90, there appeared to be an increase in longitudinal strength with transverse loading.

2. The effect of residual stress on longitudinal strength for various geometries was determined for the various loading configurations.

3. The effects of normal pressure were negligible for uniaxial longitudinal compressive strength for $b/t=50$ or less. For greater b/t ratios, the biaxial strength decreased rapidly and non-linearly to as high as 40% for $b/t=90$.

4. The small-scale tests agreed with previously reported large-scale tests.

The results of the polyaxial tests on tubes discussed in SSC-217 and on the single panels, grillages, and three grillage girder reported in SSC-223 when corrected for the effects of residual stresses and stresses caused by normal pressure loading yield the same values of plate strength within 7%.

It is recognized that these studies are quite idealized and that the design features of ships serve to complicate the application of the results. In spite of the high cost of directly pursuing large-scale tests (especially the full-scale tests suggested in 1946) the Ship Structure Committee will continue to pursue this goal by developing improvements in basic theory supported by suitable model experiments until the base of knowledge justifies verification by large-scale tests.

Fracture. The problems of fracture have been quantitatively examined by various researchers. For truly brittle and amorphous materials such as glass, the behavioral explanations are relatively simple and analytical results conform with experimental findings. The ability of metals to deform plastically complicates the analysis. The inter-relating factors of plastic zone size, shape, and rate of growth are dependent on material properties both chemical and environmental such as stress state or design detail.

A long-term (1954-1966) continuously-supported project was carried out by the Ship Structure Committee to develop an understanding of the factors that govern the brittle behavior of mild steels and the relevant micro-mechanisms of fracture. A discussion of the program can be found in SSC-182 with a summary in SSC-183. This research program initiated the International Conference on Fracture in Swampscott, Massachusetts in 1959 with subsequent conferences to follow and ultimately giving impetus to the International Journal of Fracture in 1965.

Using surface replication and three-

dimension metallography, it became possible to study the processes of twinning, slip, carbide cracking, void formation, and microcleavage of both iron and mild steels in tensile testing. These studies of the microfracturing process have led to a better understanding of the metallurgical phenomena of fracture but also pointed up the need to make a connection with the macrofracturing process, the crack propagation in plates.

Plastic zone formation is an important parameter of the fracture problem. SSC-191 considered the development of plastic zones generated by both sharp through cracks and blunter notches. By using Fe-3Si steel, which permits sensitive etching, the growth and fractures of the plastic zone could be studied. Both surface conditions and through thickness details were observed (by means of sectioning). Additionally, through-thickness deformations were followed by monitoring the normal displacements at the surface.

SSC-219 describes an investigation into the major stages of fracture initiation, propagation, and arrest. The experimental series made use of the double cantilever beam test and Fe-3Si steel because of its etching properties already discussed with SSC-191. A number of tests were conducted on engineering steels such as A517 in order to study arrest properties. As shown in Figure (10), the fast moving crack bypasses some grains as it grows, leaving ligaments which consume large amounts of energy in rupturing. This accounts for the crack propagation resistance values estimates in these experiments. As reported the most important result was that the study of plastic zones ahead of the advancing brittle crack indicated that linear elastic fracture mechanics can be applied to the problem of crack propagation and arrest.

A follow-up project was reported in SSC-242 which combined the results of an Army Research Office-sponsored study concerned with the response of high-strength steels to fast-running cracks with the Ship Structure Committee effort involving unstable fractures in ship plates. The wedge-loaded DCB test discussed in SSC-219 was used with a starter section of 4340 steel electron-beam welded to the ASTM A517F test section, as shown in Figure (11). It is thus possible to confront the test material with a fast-moving crack under controlled conditions close to the transition temperature. A theoretical analysis based on a Timoshenko beam on elastic foundation was extended to the duplex test pieces. It is now possible to derive dynamic fracture energy or fracture toughness values either from the

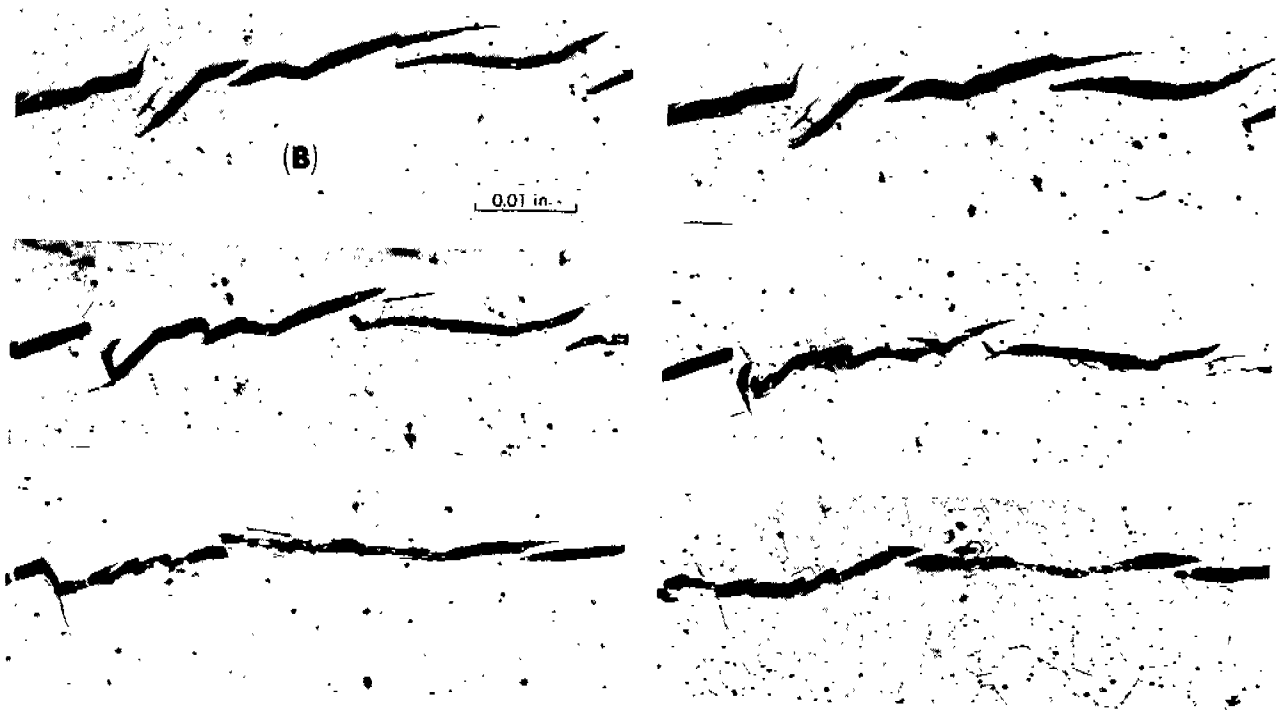

Fig. 10 - Interconnections Between Microcracks Revealed by Progressive Sectioning. The Depth of Each Section Below the Starting Section is Indicated.

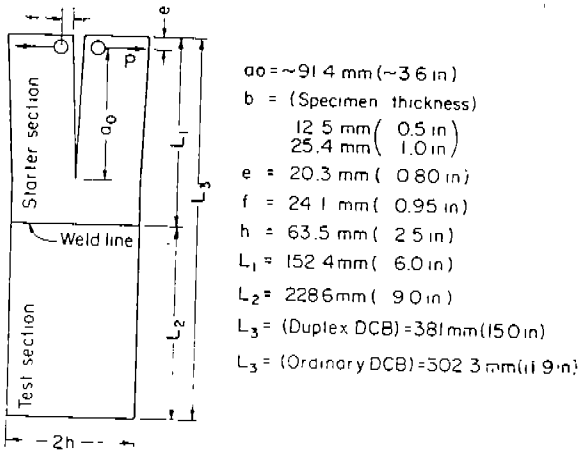

Fig. 11 - Dimensions of Duplex Wedge-Loaded, Double-Cantilevered-Beam Test Specimen.

velocity of the crack in the test section or the length of the crack at arrest. One important conclusion is that the fracture arrest is controlled by the history of energy dissipation throughout the propagation phase rather than the traditional concept of arrest toughness at the point of arrest. As one example of the importance of this conclusion, the prior arrest toughness approach implied that arrest is instantaneous when the strain energy release rate is less than the energy required at the crack tip to produce crack extension. Thus, a strip of tough material just wide enough to contain the heavily strained region adjacent to the crack tip would be an adequate crack arrestor. The new concept advanced in SSC-242 would require that the arrestor be wide enough to absorb the kinetic energy stored in the structure. Subsequent research is needed to verify this concept and to derive a suitable design criterion. The results of this Ship Structure Committee effort will be published soon. The development of new approaches to modelling the fracture arrest phenomenon and revisions in theory to explain the results have led to follow on studies to be pursued by the Nuclear Regulatory Commission. These will be followed by the Ship Structure Committee and additional projects to apply future findings to the ship field may be undertaken.

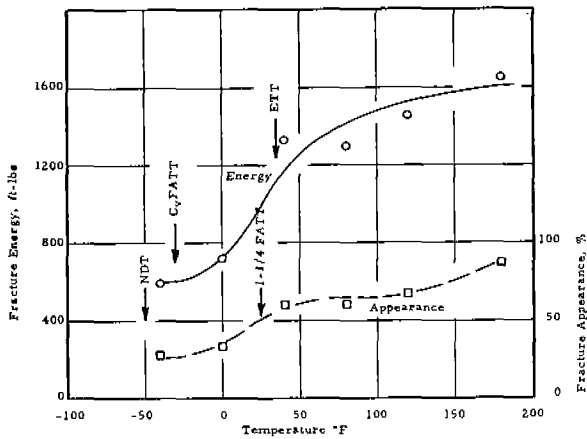

Fig. 12 - Impact Test Results on 1-1/4-Inch Base Plate.

Because of the complexity, early studies were directed at metallurgical properties and various material tests such as the Navy Drop Weight Test, explosion bulge, and Charpy-Vee impact tests. These were all small-specimen tests, and a correlation was needed between these tests and the full-scale behavior of a structure. SSC-204 reports results of a program which had as its main objective the development of a structural test to simulate service behavior.

Testing was conducted on an ASTM A212 Grade B pressure vessel steel with known fracture sensitivity to compare with ABS Class C ship steel. Unfortunately, the scatter that was present in the test series and the limited number of tests prevents the drawing of concrete conclusions. In fact, the Ship Research Committee noted in this instance that wide-plate tests did not provide any more information than that which could be obtained from small-scale tests.

SSC-199 and 232 contain a comparison of the structural behavior of ship structures built of HSLA-Q&T steel with those of similar structures made of carbon steel. The survey portion of the study reported in SSC-199 concluded that fast fracture was possible in HSLA-Q&T steels at stress levels below yield; the actual stress could be a function of flaw size; and fracture mechanics methods could be utilized if quantitative data were available. SSC-232 further reported additional testing (using A514 and 517 materials) showing that fracture resistance is increased by using stiffeners and that welds using heat inputs of 25 to 50 KJ/in. can have a fracture resistance equal to the base plate. Perhaps, most importantly, the results of Charpy-Vee as an index of transition behavior were questioned as shown by Figure (12) and (13) where the fracture appearance transition temperature (FATT) is considerably different

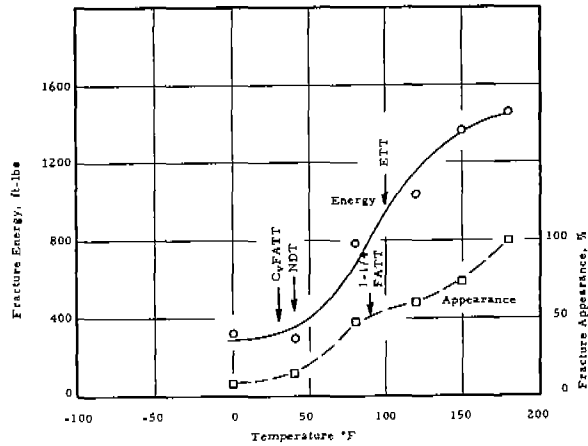

Fig. 13 - Impact Test Results on 2-Inch Base Plate.

for Charpy-Vee (C_v) and the 1 1/4-inch and 2-inch impact tests.

The Ship Structure Committee has undertaken a program to develop and validate rational toughness criteria for ship steels. The first report of this effort is SSC-244 which describes the theoretical development of such criteria. Essentially, it would require a toughness level (at 0°C) of 0.9, the ratio of critical material toughness under dynamic loading to yield strength under the same loading. Since this cannot be measured directly, the requirements are established in terms of nil ductility transition temperature which should be a maximum of 0°F and dynamic tear test energy values measured at 75°F for the base metal, weld, metal and heat-affected-zone materials in the primary load-carrying members varying with yield strength. Fail-safe design employing crack arrestors is also considered.

An exploratory program was undertaken and reported in SSC-248 to characterize on a semi-statistical basis the dynamic fracture toughness of ordinary-strength shipbuilding steels. The steels investigated were ABS Grades A, B, C, D, E, and CS. These steels were obtained at random from several shipyards and steel mills in an attempt to characterize current steel-making practice. The fracture toughness trends were defined by means of drop weight nil ductility temperature, one inch dynamic tear, and standard Charpy-Vee notch tests. The study showed all the ABS Grades A, B, and C plates tested would fail the 0°F maximum NDT criteria proposed by SSC-244.

Overall the non-heat-treated ABS Grades A, B, and C steels that were tested were found to have insufficient toughness to meet the proposed fracture toughness criteria. The normalized plates of C, D, E, and CS were found to have improved toughness trends that

could meet the proposed criteria in most cases.

New studies are being initiated to first broaden the scope of steels tested in the original steel characterization pilot study, and second to attempt to determine realistic loading rates. It is thought that the proposed fracture control guidelines (SSC-244) being based on dynamic loading may be too severe for actual service conditions.

Fabrication and Quality Control. In this research attention is directed toward the manufacturing process and its effect on the adequacy of the ships' structure.

Distortion in structure is often corrected by means of flame-straightening techniques. Although this is generally acceptable for mild steels, it was feared that for quenched and tempered high-strength, low-alloy steels such a procedure would alter the material characteristics. The benefit of those properties would then be lost to the structure.

The lead report in this program was SSC-198 which examined first the problem of distortion and the available knowledge (1969) on the effects of flame straightening and combination thermal and plastic strain cycles.

Distortion is primarily caused by locally-applied heat in the weld zone and the restraint provided by the cooler metal to either side and by structural supports. Typically, the distortion occurs because of three-dimensional changes shown in Figure (14). The literature search revealed gaps in knowledge concerning flame straightening of the HSLA-Q&T steels and recommended that these gaps be filled by subsequent research. A test schedule was developed to provide the needed data.

The Ship Structure Committee pursued this problem and in 1970 issued SSC-207 which determined the effects of both mechanical straightening and flame straightening on the properties of ship type steels. The test series included mechanical straightening at room temperature, 1000°F and 1300°F; flame straightening in the range of 1100°F - 1200°F and 1300°F - 1400°F. A controlled distortion was introduced into the specimens and drop weight tear tests were conducted to assess the effect of straightening on the notch toughness of steels. These tests were conducted on ABS-B, A-441, A-537, and A-517 Grade A steels.

As shown in Table II a significant decrease in notch toughness occurred in A-517A under flame straightening at 1300°F-1400°F. A somewhat lesser effect was observed at the 1100°F-1200°F range.

The effects of testing on the other steel grades was not significant. Mechanical straightening did not degrade the material properties of any of the steels.

In SSC-235 the studies were extended for flame straightening on several steels, including A-537B, NAXTRA-100, and T-1, which are quenched and tempered steels. The normalized steel was A-537A and the as-rolled steels were ABS-B, ABS-C, and ASTM A441. The time at temperature was evaluated for effect on both impact and tensile properties. Patterns of heat application were considered. SSC-235 showed that with proper safeguards flame straightening was possible for the grades of steel considered and SSC-247, developed with the cooperation of a major shipyard, demonstrates a technique that provides an effective, practical, yet controlled method of flame straightening of the quenched-and-tempered steels in lieu of the prevailing method of cutting and replacing the distorted plate.

Nondestructive testing was the subject of a series of SSC reports. In terms of demand, SSC-177 was one of the most popular and accepted reports of the series. Published in 1969, it represented the views of the Weld Flaw Evaluation Committee which was formed under the auspices of the National Academy of Sciences. The members of the Committee had broad experience in nondestructive testing. The document is intended to be a "guide," not a technical report and as such, presents the essential information for acceptance/rejection radiographic standards. A short discussion of visual inspection standards, inspection procedures, and interpretation standards for ship welds were included. Although ultrasonic inspection was mentioned, there was insufficient experience at the time to go beyond acknowledgement of the method and further validation.

Following the study into radiography inspection SSC-213 examined the question of ultrasonic inspection. The radiographic acceptance limits established for welds in SSC-177 were retained for SSC-213. Thus the standards are compatible, although in some cases one inspection technique would be preferred over another. The procedures and acceptance limits would be suitable for contact ultrasonic inspection of steel butt welds in thickness range of 1/4 to 2 inches.

Specialized Applications

The significant and rapid changes in ship parameters and missions has prompted the Ship Structure Committee to undertake a variety of feasibility

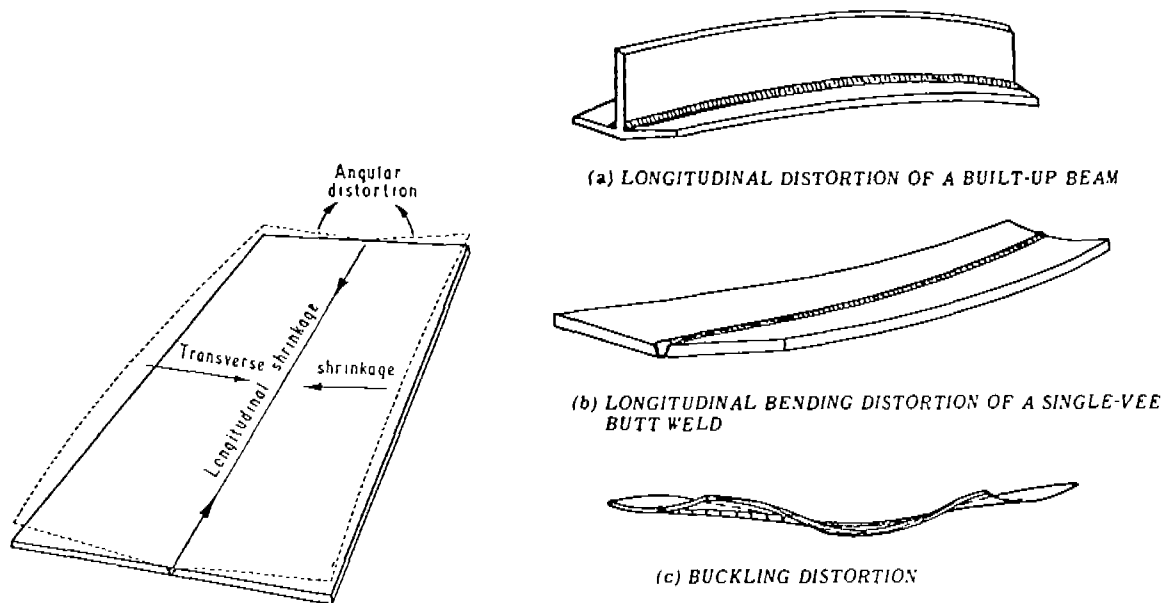

Fig. 14 - Typical Welding Distortions.

TABLE II - Increase in Transition Temperature Due to Straightening.

Alloy	Straightening Temperature, F	Change in Transition Temperature, F	
		Unwelded Plate	Welded Plate
<u>Cold Straightened</u>			
A517, Grade A; 1/2"	RT	- 6	- 8
A517, Grade A; 3/8"	RT	+ 4	-11
A537; 1/2"	RT	+25	+30
A441; 1/2"	RT	+16	- 2
ABS-B; 1/2"	RT	+33	+20
<u>Mechanically Straightened</u>			
A517, Grade A; 1/2"	1300	-44	- 5
A517, Grade A; 1/2"	1000	-15	0
A517, Grade A; 3/8"	1200	0	+ 9
A537; 1/2"	1200	0	+ 2
A441; 1/2"	1200	+22	0
ABS-B; 1/2"	1200	+11	0
<u>Flame Straightened</u>			
A517, Grade A; 1/2"	1300-1400	+108	+ 86
A517, Grade A; 1/2"	1100-1200	+ 75	+ 25
A517, Grade A; 3/8"	1300-1400	+205	+114
A517, Grade A; 3/8"	1100-1200	+113	+ 84
A537; 1/2"	1300-1400	+ 28	+ 15
A537; 1/2"	1100-1200	+ 25	+ 12
A441; 1/2"	1300-1400	+ 12	- 3
A441; 1/2"	1100-1200	+ 16	*
ABS-B; 1/2"	1300-1400	+ 18	+ 5
ABS-B; 1/2"	1100-1200	*	- 20

* Not determined.

studies in recent years. The concepts pursued were specialized either because of the vessel type, method of construction, or materials employed. One connecting thread in the development of these projects was a level of interest among the individual sponsors of the Ship Structure Committee to recognize and anticipate new problem areas. Although the impetus and funding at any one agency was insufficient to carry out the task, it was possible to undertake a variety of projects because of general support by the sponsoring agencies of the Ship Structure Committee.

Special Materials. The increased usage of high-strength low-alloy (HSLA) steels prompted a study into determining if an emergency welding procedure could be developed for those areas of the ship using high-strength steels until permanent repairs were possible. SSC-195 recommends in part that a manual shielded metal arc process be used with a ASTM A298-62T type 310-16 stainless steel electrode. Preheating is only required when the ambient temperature is below 32° F.

There have also been two noteworthy projects concerning materials other than steel for marine use. The first was published as SSC-218 and examined the use of aluminum in large vessels in particular a bulk carrier. The resulting study not only demonstrates that the existing aluminum technology was sufficiently advanced to consider such uses but that overall economic considerations might justify such use as well. This report is a valuable reference for any designer considering aluminum for a large vessel. The design problem is examined not only for the physical constraints imposed because aluminum is used but also because of regulatory constraints imposed because steel is not used.

Thirty-six conclusions were drawn from this study that cover a review of aluminum alloys, operational experience of existing ships, design criteria for hull structures, fabrication of large aluminum hulls, fire protection, installation of equipment, operation and cost studies.

A similar study was conducted for glass reinforced plastics and reported in SSC-224. The conclusions, both physical and financial, do not support the use of glass reinforced plastics as a prime hull structural material at this time based on costs and the combustibility of the material. However, major components such as deckhouses, hatch-covers, kingposts and bow modules are shown to be economically justified in some cases.

Special Vessels. Catamarans are

an ancient vessel form. Recently, the advantages of large-deck area, high transverse stability, and excellent low-speed maneuverability sparked a serious interest in this configuration. A principal detracting factor in the design of large catamarans is the lack of structural load definition. SSC-222 contains a survey and analysis of the present state of knowledge together with recommendations of areas for future research. One conclusion was that there are no unknown technological barriers that would force cancellation of the concept for present application in large ship sizes. This does not imply that problems do not exist that would require some attention. The principal problem in catamaran design is the strength of the cross structure. Present design methods will provide an overall conservative design. Economics, individual shipyard construction capabilities, dry dock and pier facilities appear to be the major constraints to catamaran size.

The transport of liquified natural gas is a topic of much current interest. One subject of particular concern involves the effect of a rupturing cargo tank spilling the cryogenic cargo on the primary hull structure. A study was undertaken that included some experimental studies to validate theoretical predictions (SSC-241). Temperatures and stresses associated with ruptures reached peak values and maintained peaks for several minutes in a quasistatic behavior pattern. Also of interest was the fact that convection dominates the heat transfer process with radiation being an order of magnitude less and conduction being two orders of magnitude less. An important result of the project was the good agreement of the maximum experimental strains with theoretical predictions made from simple calculations.

The transportation of cargoes in independent pressure tanks on barges has been increasing both on river systems and on the open seas. The potential of larger sizes has led to the research reported in SSC-205. The structural problem created by the interaction of the barge hull through the saddle supports to the tank itself is both a significant factor and a matter for reliable analysis procedures. The existing accepted design procedure calculated a stress distribution based on a moment of inertia ratio between the tanks and the barge hull. In reviewing this analysis method it was concluded that it was adequate for river barges, but that prior to extending it to larger tanks going to sea further work might be needed to develop experimental and analytical analyses of an as built tanker, fatigue analysis, buckling analysis,

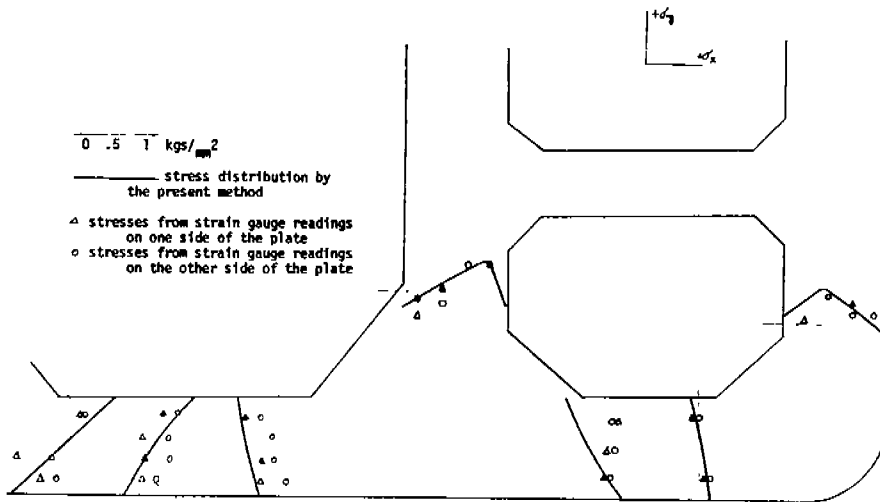

Fig. 15 - Normal Stresses on Web Frame No. 127 for Load Condition 5, JOHN A. McCONE.

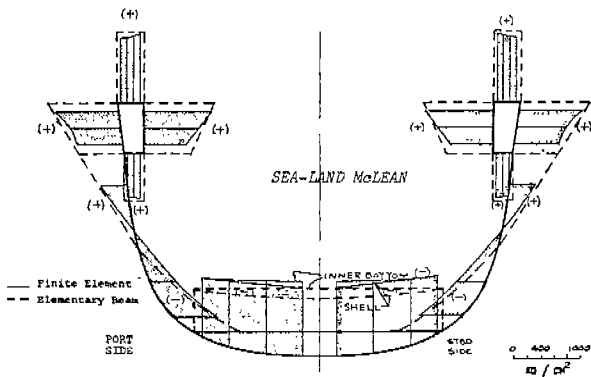

Fig. 16 - Total Longitudinal Stresses of Section Frame 222 (First Loading Case).

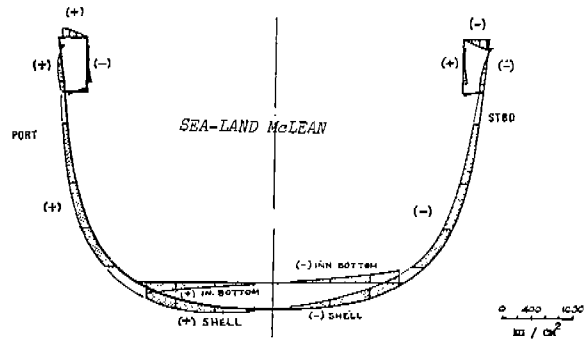

Fig. 18 - Longitudinal Stresses Due to Anti-Symmetrical Loadings of Section Frame 222 (Mainly Due to Lateral Bending Loads) (First Loading Case).

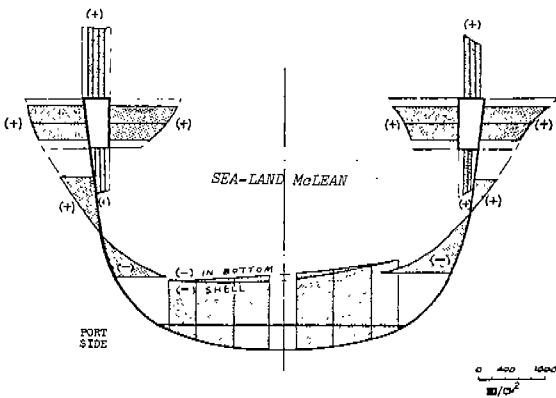

Fig. 17 - Longitudinal Stresses Due to Pure Vertical Bending Loads of Section Frame 222 - (Symmetric Loading) (First Loading Case).

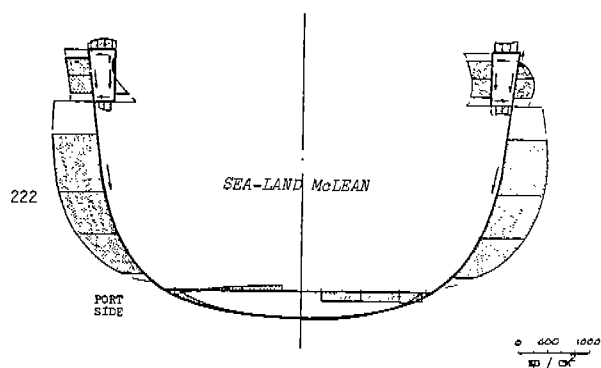

Fig. 19 - Total Shear Stresses of Section Frame 222 (First Loading Case).

slamming investigations, and tank-barge saddle interaction analysis.

Specialized Forms of Construction.
The problem of structural analysis of the two principal types of framing systems, transverse and longitudinal, can be somewhat simplified if advantage is made of idealized assumptions based on the physical attributes of the framing systems. A great deal of attention has been paid in recent years to generalized structural analysis techniques such as the finite element method. A favorable attribute of these techniques is that it is now possible to obtain structural analyses results for large complex structures. They have in general proven to be too costly to be used as design tools. In the end they are used to validate design configurations developed by other means.

The Ship Structure Committee pursued two programs aimed at providing design tools that would not be as costly as the more generalized methods. Both programs take advantage of the attributes of the two principal framing systems in order to simplify the analysis. SSC-215 and 216 present the theoretical assumptions and the computer coding for a design procedure for transversely framed ships. The method depends heavily on the grillage beam on an elastic foundation analysis techniques. The advantage of this technique is realized because ships frames tend to be regular with few exceptions. This simplifies the analysis. If it were not for this fact the more costly finite element method for obtaining the grillage solution would have to be used. SSC-215 was only a first step in developing a rational design procedure. However, the coding did not incorporate all the special loading conditions that should be considered in an overall analysis.

A second project was initiated for longitudinally framed ships and resulted in SSC Reports 225-228. However, the result is not truly a design program but rather an analysis program where advantage was taken of regular geometric properties. In this effort three principal forms of analysis were used: line-solution methods, finite-element methods, and the grillage beam-on-an elastic-foundation approach. Comparison runs made between the SSC program and a commercial finite element routine on a simple box girder problem confirmed the accuracy of the method. An analysis based on a calibration experiment for the instrumentation of the tanker *JOHN A. McCONE* also revealed good agreement, although a finer mesh could have improved the results, Figure (15).

As part of the SL-7 class container-ship program, the American Bureau of

Shipping undertook an analysis of the ship using the Displacement Automated Integrated System (DAISY) finite element program to provide stress information for the placing of strain gauges aboard the SL-7. The results of that analysis are reported in SSC-243. The ship is mathematically loaded with containers and using oblique quasi-static regular waves, is subjected to combined vertical, lateral and torsional loads. Stress distributions, especially in the deck region are presented and investigated Figures (16--19). Early results of this project helped in the determination of the final location of some strain gauges.

The development of rational criteria for the design of hull structures is one of the primary goals of the Ship Structure Committee. In support of that goal the Committee provided partial support for a group of noted investigators to examine the present level of technology in hull structural design. The effort is essentially a condensation of prior work of the several authors and was technically reviewed by the Design Procedure and Philosophy (HS-4) Panel of the Society of Naval Architects and Marine Engineers. The discussions are contained in a report "Ship Structural Design Concepts" (Ref. 4).

SUMMARY

It is interesting to note that the Board of Investigation convened by the Secretary of the Navy to inquire into the design and methods of construction of welded steel merchant vessels, issued their final report in 1946 with the following goals recommended:

- a. To further studies into ship-building materials by studying the effects of welding on the structural performance of ship steel, the fundamental factors affecting flow and fracture of metals, and to develop practical tests for evaluating materials to be used in fabrication.
- b. To further the study of the ship's structure by determining the loads to which the ship is subjected by waves, by examining design and fabrication details, by studying the structural performance of ship hull girder to include testing to failure, by studying effects of riveted longitudinal joints, and determining the merits of various structural design details.

This is a fairly comprehensive set of objectives, which led to the formation of the Ship Structure Committee.

If ship design had remained static following World War II the problems that existed at that time could have been sufficiently defined within a few years and thus restricted the need for further research. But shipbuilding is dynamic and as new demands have been placed on designers, a need has been created for better understanding of the structural behavior of ships. The needed research paralleled earlier research, with the introduction of different materials. This required characterizations that were similar to data cataloging efforts for the prevalent materials of an earlier time. Similarly, internal or external environmental condition, dimension, hull form, etc. for new ships required new studies directed to give the designer and operator the confidence to proceed.

The research program was developed to anticipate changes in ship hull requirements, materials and fabrication as a result of global competition, new markets, evolving techniques, and modified classification rules. Concern is constantly being expressed regarding the capability of the program to respond in an effective and timely manner. However, progress is only achieved at a pace compatible with available resources. Within this framework, it behooves all parties involved in the design or operation of ships to place sufficient restraints upon new designs until sufficient information is available to justify changes that assure ample safety for the ship and its crew.

To overcome costly design constraints, the research program must be continued in such areas as extending the ship response program, including associated model testing and data analyses to other ship types such as the hull and tanks for cryogenic products, some components of mobile drilling units, catamarans, tankers, barges and high performance craft.

Additionally, a comparison of full-scale and model data on slamming phenomena has not been possible on commercial ships in the past primarily because the full-scale slamming data have been insufficient in quantity or scope. This is in part due to the lack of the proper instrumentation package and the desire of most ship masters to avoid slams whenever possible.

The reduction in scantling sizes and shell platings owing to the use of higher strength steels and corrosion protection devices has raised many questions concerning the criteria on acceptable vibration limits, the source of vibration of different modes, and the methods of minimizing or damping out this adverse phenomena. In this connection, studies of model test methods

and procedures for obtaining input data to perform vibration and structural analyses are needed.

Studies need to be undertaken to improve motion prediction techniques in the transverse plane. Without such assurances, a limitation is imposed on the rational design of ships in cases where a low ratio of length to breadth and a high ratio of breadth to depth exist and transverse and torsional loads are expected to be significant. These proportions are being used for large dry and liquid bulk carriers.

Uncertainties in fuel costs in recent years have accelerated interest in the use of nuclear propulsion. There has also existed the concern for pollution resulting from the collision or grounding of a bulk carrier. In both cases there is a constant need to explore and improve the design of protective systems. It is recognized that strandings and collisions do occur. Records of their damage do exist and could be of great value when applying reliability theory to ship structural design. It is first necessary to format the data from those records into a system compatible with the analysis technique. Sources must be obtained for any missing data.

The advent of new fabrication techniques and different materials requires a continuous appraisal of the various factors that affect their acceptability and performance in ship hull structures. There must be adequate knowledge developed not only of the materials' inherent characteristics, but also of the effects that may be induced by the fabricating and operating environments during construction and service. Good progress has been made in some aspects of this problem, but it is essential that it be continued. The determination of the ultimate strength of the ship hull girder has been elusive because of the various modes of failure and different combinations of loading. Approaches to provide solutions to some of the problems encountered in developing the ultimate strength have been pursued in a piecemeal fashion. Each facet is being considered separately with the hope that the information so gathered can be condensed into one pure hypothesis.

Efforts must be continued to assure the attainment of that goal. The research program should progressively develop a computer capability for the design (not analysis) of the primary hull structure of cargo vessels, with adaptability for modification for the next generation of ships. Such a program should ultimately be able to accept the loading supplied by a computer

response program that, through several iterations, should produce an optimum design.

In summary, theory and experimentation has made it possible to generate a more direct approach for investigating many variables and to discern the appropriate direction for coping with anticipated problems. Opinions are often advanced on the composition of a research program. Proponents of basic research argue that it must be continuously supported in order to provide a constant stream of new information in order to avoid crash programs and costly delays. Others argue that basic research should be sporadically supported to insure that a period of time is available to digest the data and isolate the most fruitful efforts for future support. In practice the Ship Structure Committee has pursued a combination of the two. At any given time there has usually been a portion which can be identified as supporting basic research. Those projects have been carried to the point where follow on studies could be initiated by the Ship Structure Committee or other organizations. At the same time projects have been supported which led directly to a commercial application. There are no indications that this practice will not continue. The mix between basic and applied research may vary, but the organization of the Ship Structure Committee includ-

ing the technical support it receives from the Ship Research Committee and the advices through the liaison with the Hull Structure Committee of SNAME and other liaison organizations provides a balanced program.

The proven capability of the Ship Structure Committee to meet the dynamic and changing needs of the maritime industry should and will continue with the support of the maritime community and specifically the sponsoring agencies.

REFERENCES

- (1) E. A. Wright, Jr., F. Jonassen, and H. G. Acker, "Research Under the Ship Structure Committee", Trans. SNAME, Vol. 60, 1952, pp 223-272.
- (2) S. R. Heller, Jr., A. R. Lytle, R. Nielsen, Jr., and J. Vasta, "Twenty Years of Research Under the Ship Structure Committee", Trans. SNAME, Vol. 75, 1967, pp 332-384 also SSC 182.
- (3) B. V. Korvin-Kroukovsky, "Theory of Seakeeping", New York, N.Y. SNAME, 1961.
- (4) "Ship Structural Design Concepts", edited by J. H. Evans, 1974 - NTIS AD 782198.

¹The opinions expressed are those of the authors alone and should not be construed as reflecting the official views of any Department of the U.S. Government.

APPENDIX 1

SHIP STRUCTURE COMMITTEE REPORTS

These documents are distributed by the National Technical Information Service, Springfield, VA. 22151

- SSC-172, *Crack Extension and Propagation Under Plane Stress* by A. R. Rosenfield, P. K. Dai and G. T. Hahn. March 1966. AD 480619
- SSC-173, *Exhaustion of Ductility Under Notch Constraint Following Uniform Pre-Straining* by C. Mylonas, S. Kobayashi and A. Armenakas. August 1966. AD 637143
- SSC-174, *Investigation of Residual Stresses in Steel Weldments* by K. Masubuchi and D. C. Martin. September 1966. AD 639619
- SSC-175, *Mechanical Properties of a High-Manganese, Low-Carbon Steel for Welded Heavy-Section Ship Plate* by R. D. Stout and C. R. Roper, Jr. August 1966. AD 637211
- SSC-176, *Biennial Report of the Ship Structure Committee*. June 1966. AD 64133
- SSC-177, *Guide for Interpretation of Non-Destructive Tests of Welds in Ship Hull Structures* by The Weld Flaw Evaluation Committee. September 1966. AD 639053
- SSC-178, *A Survey of Some Recent British Work on the Behaviour of Warship Structures* by J. Clarkson. November 1966. AD 644738
- SSC-179, *Residual Strains and Displacements within the Plastic Zone Ahead of a Crack* by J. Cammett, A. R. Rosenfield, and G. T. Hahn. November 1966. AD 644815
- SSC-180, *Experimental Determination of Plastic Constraint Ahead of a Sharp Crack Under Plane-Strain Conditions* by G. T. Hahn and A. R. Rosenfield. December 1966. AD 646034
- SSC-181, *Results from Full-Scale Measurements of Midship Bending Stresses on Two Dry-Cargo Ships -- Report #2* by D. J. Fritch, F. C. Bailey, and J. W. Wheaton. March 1967. AD 650239
- SSC-182, *Twenty Years of Research Under the Ship Structure Committee* by A. R. Lytle, S. R. Heller, R. Nielsen, Jr., and J. Vasta. December 1967. AD 663677
- SSC-183, *Metallurgical Structure and the Brittle Behaviour of Steel* by Morris Cohen. May 1968. AD 670574.
- SSC-184, *Exhaustion of Ductility in Compressed Bars with Holes* by S. Kobayashi and C. Mylonas. June 1968. AD 670487
- SSC-185, *Effect of Surface Condition on the Exhaustion of Ductility by Cold or Hot Straining* by J. Dvorak and C. Mylonas. July 1968. AD 672897
- SSC-186, *On the Effect of Ship Stiffness Upon the Structural Response of a Cargo Ship to an Impulsive Load* by Manley St. Denis. September 1968. AD 675639
- SSC-187, *Biennial Report of Ship Structure Committee*. June 1968. AD 675022
- SSC-188, *Effect of Repeated Loads on the Low Temperature Fracture Behavior of Notched and Welded Plates*, by W. H. Munse, J. P. Cannon and J. F. Kiefner. October 1968. AD 676722
- SSC-189, *The Video Tape Recording of Ultrasonic Test Information* by R. A. Youshaw, C. H. Dyer and E. L. Criscuolo. October 1968. AD 677894
- SSC-190, *Bending Moment Distribution in a Mariner Cargo Ship Model in Regular and Irregular Waves of Extreme Steepness* by Naresh M. Maniar and Edward Numata. November 1968. AD 679187
- SSC-191, *Plastic Flow in the Locale on Notches and Cracks in Fe-3Si Steel Under Conditions Approaching Plane Strain* by G. T. Hahn and A. R. Rosenfield. November 1968. AD 680123.
- SSC-192, *Notch Brittleness After Fracture* by C. Mylonas and S. Kobayashi. January 1969. AD 681051
- SSC-193, *Development of Mathematical Models For Describing Ship Structural Response in Waves* by Paul Kaplan. January 1969. AD 682591
- SSC-194, *Feasibility Study of Model Test on Ship Hull Girder* by Herbert Becker. May 1969. AD 687220
- SSC-195, *Recommended Emergency Welding Procedure for Temporary Repairs of Ship Steels* by A. L. Lowenberg and P. D. Watson. May 1969. AD 668119
- SSC-196, *Analysis and Interpretation of Full-Scale Data on Midship Bending Stresses of Dry Cargo Ships* by Dan Hoffman and Edward V. Lewis. June 1969. AD 689657

- SSC-197, *An Investigation of the Utility of Computer Simulation to Predict Ship Structural Response in Waves* by P. Kaplan, T. P. Sargent and A. I. Raff. June 1969. AD 690229
- SSC-198, *Flame Straightening and Its Effect on Base Metal Properties* by H. E. Pattee, R. M. Evans and R. E. Monroe. August 1969. AD 691555
- SSC-199, *Study of the Factors Which Affect the Adequacy of High-Strength Low-Alloy Steel Weldments for Cargo Ship Hulls* by A. L. Lowenberg, E. B. Norris, A. G. Pickett and R. D. Wylie. August 1969. AD 692262
- SSC-200, *Index of Ship Structure Committee Reports*. January 1969. AD 683360
- SSC-201, *Midship Wave Bending Moment in a Model of the Cargo Ship "Wolverine State" Running at Oblique Headings in Regular Waves* by M. J. Chiocco and E. Numata. September 1969. AD 695123
- SSC-202, *Midship Wave Bending Moment in a Model of the Cargo Ship "California Bear" Running at Oblique Headings in Regular Waves* by E. Numata and W. F. Yonkers. November 1969. AD 698847
- SSC-203, *Annual Report of the Ship Structure Committee*. November 1969. AD 699240
- SSC-204, *Simulated Performance Testing for Ship Structure Components* by R. Sherman. 1970. AD 705398
- SSC-205, *Structural Design Review of Long, Cylindrical, Liquid-Filled Independent Cargo Tank Barges* by C. W. Bascom. 1970. AD 708565
- SSC-206, *Permissible Stresses and Their Limitations* by J. J. Nibbering. 1970. AD 710520
- SSC-207, *Effect of Flame and Mechanical Straightening on Material Properties of Weldments* by H. E. Pattee, R. M. Evans and R. E. Monroe. 1970. AD 710521
- SSC-208, *Slamming of Ships: A Critical Review of the Current State of Knowledge* by J. R. Henry and F. C. Bailey. 1970. AD 711267
- SSC-209, *Results from Full-Scale Measurements of Midship Bending Stresses on Three Dry Cargo Ships* by I. J. Walters and F. C. Bailey. 1970. AD 712183
- SSC-210, *Analysis of Slamming Data from "S.S. Wolverine State"* by J. W. Wheaton, C. H. Kano, P. T. Diamant and F. C. Bailey. 1970. AD 713196
- SSC-211, *Design and Installation of a Ship Response Instrumentation System Aboard the Container Vessel "S.S. Boston"* by R. A. Fain, J. Q. Cragin and B. H. Schofield. (Not to be published).
- SSC-212, *Ship Response Instrumentation Aboard the Container Vessel "S.S. Boston": Results from the 1st Operational Season in North Atlantic Service* by R. A. Fain, J. Q. Cragin and B. H. Schofield. 1970. AD 712186
- SSC-213, *A Guide for Ultrasonic Testing and Evaluation of Weld Flaws* by R. A. Youshaw. 1970. AD 713202
- SSC-214, *Ship Response Instrumentation Aboard the Container Vessel "S.S. Boston": Results from Two Operational Seasons in North Atlantic Service* by J. Q. Cragin. 1970. AD 712187
- SSC-215, *A Guide for the Synthesis of Ship Structures Part One - The Midship Hold of a Transversely-Framed Dry Cargo Ship* by Manley St. Denis. 1970. AD 717357
- SSC-216, *Program "Tranship" - A Computer Program for the Design of the Midship Section of a Transversely-Framed Dry Cargo Ship - Part Two* by Manley St. Denis. 1972. AD 753531
- SSC-217, *Compressive Strength of Ship Hull Girders - Part I - Unstiffened Plates* by H. Becker, R. Goldman and J. Pozerycki. 1971. AD 717590
- SSC-218, *Design Considerations for Aluminum Hull Structures: Study of Aluminum Bulk Carrier* by C. J. Altenburg and R. J. Scott. 1971. AD 729021
- SSC-219, *Crack Propagation and Arrest in Ship and Other Steels* by G. T. Hahn, R. G. Hoagland, P. N. Mincer, A. R. Rosenfield and M. Sarrate. 1971. AD 731674
- SSC-220, *A Limited Survey of Ship Structural Damage* by S. Hawkins, G. H. Levine and R. Taggart. 1971. AD 733085
- SSC-221, *Response of the Delta Test to Specimen Variables* by L. J. McGeedy. 1971. AD 733086
- SSC-222, *Catamarans - Technological Limits to Size and Appraisal of Structural Design Information and Procedures* by N. M. Maniar and W. P. Chiang. 1971. AD 733844

- SSC-223, *Compressive Strength of Ship Hull Girders - Part II - Stiffened Plates* by H. Becker, A. Colao, R. Goldman and J. Pozerycki. 1971. AD 733811
- SSC-224, *Feasibility Study of Glass Reinforced Plastic Cargo Ship* by R. J. Scott and J. H. Sommella. 1971. AD 735113
- SSC-225, *Structural Analysis of Longitudinally Framed Ships* by R. Nielsen, P. Y. Chang and L. C. Deschamps. 1972. AD 752769
- SSC-226, *Tanker Longitudinal Strength Analysis - User's Manual and Computer Program* by R. Nielsen, P. Y. Chang and L. C. Deschamps. 1972. AD 752770
- SSC-227, *Tanker Transverse Strength Analysis - User's Manual* by R. Nielsen, P. Y. Chang and L. C. Deschamps. 1972. AD 752771
- SSC-228, *Tanker Transverse Strength Analysis - Programmer's Manual* by R. Nielsen, P. Y. Chang and L. C. Deschamps. 1972. AD 752742
- SSC-229, *Evaluation and Verification of Computer Calculations of Wave-Induced Ship Structural Loads* by P. Kaplan and A. I. Raff. 1972. AD 753220
- SSC-230, *Program SCORES -- Ship Structural Response in Waves* by A. I. Raff. 1972. AD 752468
- SSC-231, *Further Studies of Computer Simulation of Slamming and Other Wave-Induced Vibratory Structural Loadings on Ships in Waves* by P. Kaplan and T. P. Sargent. 1972. AD 752479
- SSC-232, *Study of the Factors which Affect the Adequacy of High-Strength, Low Alloy, Steel Weldments for Cargo Ship Hulls* by E. B. Norris, A. G. Pickett and R. D. Wylie. 1972. AD 752480
- SSC-233, *Correlation of Model and Full-Scale Results in Predicting Wave Bending Moment Trends* by D. Hoffman, J. Williamson and E. V. Lewis. 1972. AD 753223
- SSC-234, *Evaluation of Methods for Extrapolation of Ship Bending Stress Data* by D. Hoffman, R. van Hooff and E. V. Lewis. 1972. AD 753224
- SSC-235, *Effect of Temperature and Strain Upon Ship Steels* by R. L. Rothman and R. E. Monroe. 1973. AD 768891
- SSC-236, *A Method for Digitizing, Preparing and Using Library Tapes of Ship Stress and Environment Data* by A. E. Johnson, Jr., J. A. Flaherty and I. J. Walters. 1973. AD 767388
- SSC-237, *Computer Programs for the Digitizing and Using of Library Tapes of Ship Stress and Environment Data* by A. E. Johnson, Jr., J. A. Flaherty and I. J. Walters. 1973. AD 768863
- SSC-238, *Design and Installation of a Ship Response Instrumentation System Aboard the SL-7 Class Containership S.S. SEALAND McLEAN* by R. A. Fain. 1973. AD 780090
- SSC-239, *Wave Loads in a Model of the SL-7 Containership Running at Oblique Headings in Regular Waves* by J. F. Dalzell and M. J. Chiocco. 1973. AD 780065
- SSC-240, *Load Criteria for Ship Structural Design* by E. V. Lewis, D. Hoffman, W. M. Maclean, R. van Hooff and R. B. Zubaly. 1973. AD 767389
- SSC-241, *Thermoelastic Model Studies of Cryogenic Tanker Structure* by H. Becker and A. Colao. 1973. AD 771217
- SSC-242, *Fast Fracture Resistance and Crack Arrest in Structural Steels* by G. T. Hahn, R. G. Hoagland, M. F. Kanninen, A. R. Rosenfield and R. Sejnoha. 1973. AD 775018
- SSC-243, *Structural Analysis of SL-7 Containership Under Combined Loading of Vertical, Lateral and Torsional Moments Using Finite Element Techniques* by A. M. Elbatouti, D. Liu, and H. Y. Jan. 1974. AD A002620
- SSC-244, *Fracture-Control Guidelines for Welded Steel Ship Hulls* by S. T. Rolfe, D. M. Rhea, and B. O. Kuzmanovic. 1974. AD A004553
- SSC-245, *A Guide for Inspection of High-Strength Steel Weldments* by The Weld Flaw Evaluation Committee. (To be published)
- SSC-246, *Theoretical Estimates of Wave Loads On the SL-7 Containership in Regular and Irregular Seas* by P. Kaplan, T. P. Sargent and J. Cilmi. 1974. AD A004554
- SSC-247, *Flame Straightening Quenched-And-Tempered Steels in Ship Construction* by R. L. Rothman. 1974. AD A002621
- SSC-248, *Fracture Toughness Characterization of Shipbuilding Steels* by J. R. Hawthorne and F. J. Loss. 1975. AD 785034

- SSC-249, *Ship-Vibration Prediction Methods and Evaluation of Influence of Hull-Stiffness Variation on Vibratory Response* by R. G. Kline and J. C. Daidola. 1975. AD A008388
- SSC-250, *Bibliography for Ship-Vibration Prediction Methods and Evaluation of Influence of Hull-Stiffness Variation on Vibratory Response* by R. G. Kline and J. C. Daidola. 1975. AD A008387
- SSC-251, *A Study of Subcritical Crack Growth in Ship Steels* by P. H. Francis, J. Lankford, Jr., and F. F. Lyle, Jr. 1975.

REPORT DOCUMENTATION PAGE		READ INSTRUCTIONS BEFORE COMPLETING FORM
1. REPORT NUMBER SSC-252	2. GOVT ACCESSION NO.	3. RECIPIENT'S CATALOG NUMBER
4. TITLE (and Subtitle) Third Decade of Research Under The Ship Structure Committee		5. TYPE OF REPORT & PERIOD COVERED Special Report
		6. PERFORMING ORG. REPORT NUMBER
7. AUTHOR(s) LCDR E. A. Chazal, Jr., USCG, Professor J. E. Goldberg, J. J. Nachtsheim, R. W. Rumke and A. B. Stavovy		8. CONTRACT OR GRANT NUMBER(s) None
9. PERFORMING ORGANIZATION NAME AND ADDRESS Ship Structure Committee		10. PROGRAM ELEMENT, PROJECT, TASK AREA & WORK UNIT NUMBERS
11. CONTROLLING OFFICE NAME AND ADDRESS		12. REPORT DATE 1975
		13. NUMBER OF PAGES 25
14. MONITORING AGENCY NAME & ADDRESS (if different from Controlling Office)		15. SECURITY CLASS. (of this report) UNCLASSIFIED
		15a. DECLASSIFICATION/DOWNGRADING SCHEDULE
16. DISTRIBUTION STATEMENT (of this Report) Distribution of this document is unlimited		
17. DISTRIBUTION STATEMENT (of the abstract entered in Block 20, if different from Report)		
18. SUPPLEMENTARY NOTES		
19. KEY WORDS (Continue on reverse side if necessary and identify by block number)		
20. ABSTRACT (Continue on reverse side if necessary and identify by block number) Results of the research efforts of the Ship Structure Committee from the past decade are presented. Particular attention is given to the contributions made by this research to achieving the broad goals of the Ship Structure Committee: Design Methods, Verifications, Load Criteria, Materials Criteria, Fabrication Advanced Concepts, Information Retrieval and Dissemination, and the Teaching of Naval Architecture.		

SECURITY CLASSIFICATION OF THIS PAGE(When Data Entered)

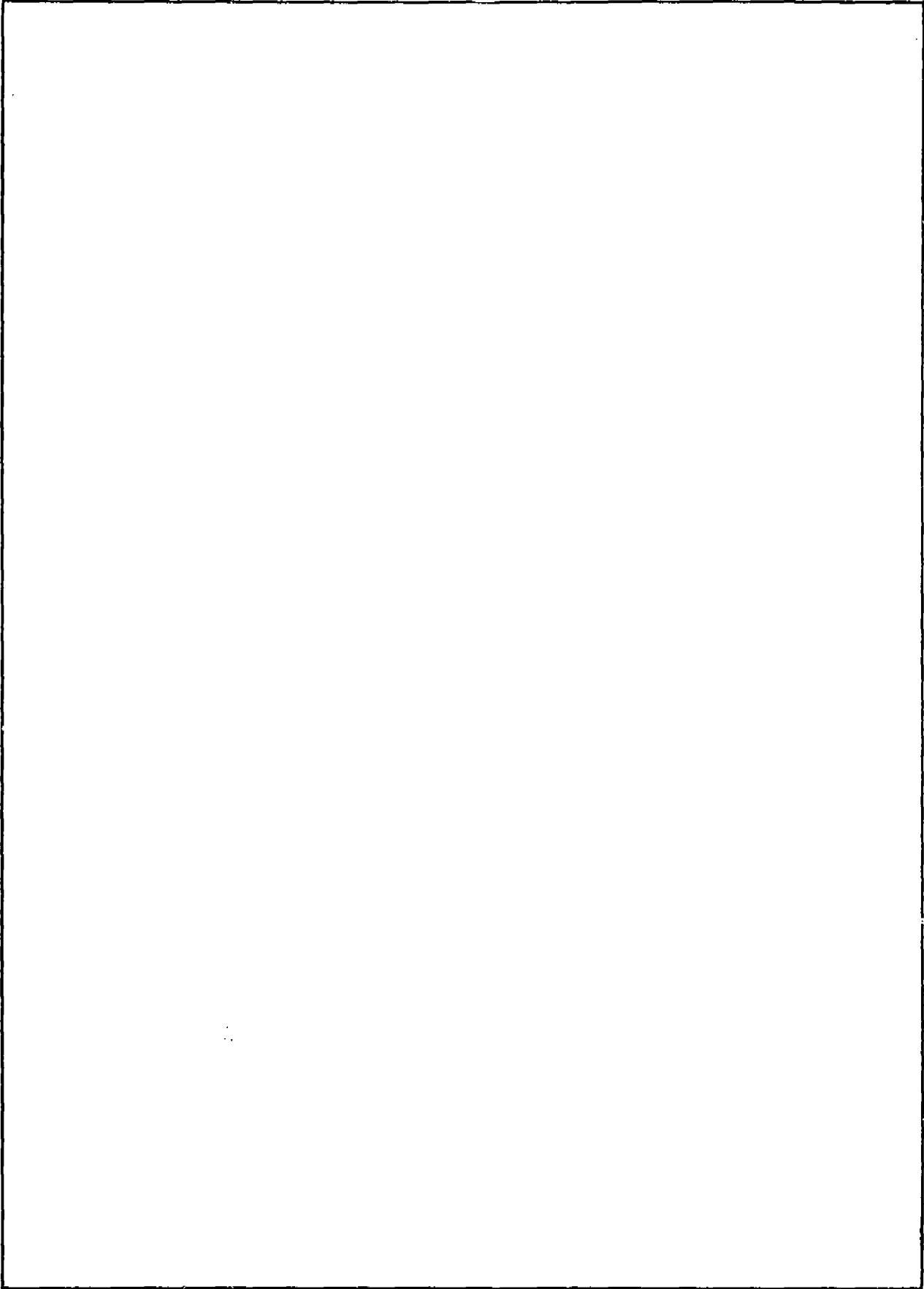

SECURITY CLASSIFICATION OF THIS PAGE(When Data Entered)

SHIP STRUCTURE COMMITTEE

The SHIP STRUCTURE COMMITTEE is constituted to prosecute a research program to improve the hull structures of ships by an extension of knowledge pertaining to design, materials and methods of fabrication.

RADM W. M. Bengert, USCG
Chief, Office of Merchant Marine Safety
U.S. Coast Guard Headquarters

Mr. P. M. Palermo
Asst. for Structures
Naval Ship Engineering Center
Naval Sea Systems Command

Mr. M. Pitkin
Asst. Administrator for
Commercial Development
Maritime Administration

Mr. K. Morland
Vice President
American Bureau of Shipping

Mr. C. J. Whitestone
Maintenance & Repair Officer
Military Sealift Command

SHIP STRUCTURE SUBCOMMITTEE

The SHIP STRUCTURE SUBCOMMITTEE acts for the Ship Structure Committee on technical matters by providing technical coordination for the determination of goals and objectives of the program, and by evaluating and interpreting the results in terms of ship structural design, construction and operation.

NAVAL SEA SYSTEMS COMMAND

Mr. C. Pohler - Member
Mr. J. B. O'Brien - Contract Administrator
Mr. G. Sorkin - Member

U.S. COAST GUARD

LCDR E. A. Chazal - Secretary
CAPT D. J. Linde - Member
LCDR D. L. Folsom - Member
CDR W. M. Devlin - Member

MARITIME ADMINISTRATION

Mr. J. Nachtsheim - Chairman
Mr. F. Dashnaw - Member
Mr. F. Seibold - Member
Mr. R. K. Kiss - Member

MILITARY SEALIFT COMMAND

Mr. D. Stein - Member
Mr. T. W. Chapman - Member
Mr. A. B. Stavovy - Member
Mr. J. G. Tuttle - Member

NATIONAL ACADEMY OF SCIENCES SHIP RESEARCH COMMITTEE

Mr. R. W. Rumke - Liaison
Prof. J. E. Goldberg - Liaison

AMERICAN BUREAU OF SHIPPING

Mr. S. G. Stiansen - Member
Mr. I. L. Stern - Member

SOCIETY OF NAVAL ARCHITECTS & MARINE ENGINEERS

Mr. A. B. Stavovy - Liaison

WELDING RESEARCH COUNCIL

Mr. K. H. Koopman - Liaison

INTERNATIONAL SHIP STRUCTURES CONGRESS

Prof. J. H. Evans - Liaison

U.S. COAST GUARD ACADEMY

CAPT C. R. Thompson - Liaison

STATE UNIV. OF N.Y. MARITIME COLLEGE

Mr. W. R. Porter - Liaison

AMERICAN IRON & STEEL INSTITUTE

Mr. R. H. Sterne - Liaison

U.S. NAVAL ACADEMY

Dr. R. Bhattacharyya - Liaison

SHIP STRUCTURE COMMITTEE PUBLICATIONS

These documents are distributed by the National Technical Information Service, Springfield, Va. 22151. These documents have been announced in the Clearinghouse journal U.S. Government Research & Development Reports (USGRDR) under the indicated AD numbers.

- SSC-243, *Structural Analysis of SL-7 Containership Under Combined Loading of Vertical, Lateral and Torsional Moments Using Finite Element Techniques* by A. M. Elbatouti, D. Liu, and H. Y. Jan. 1974. AD-A 002620.
- SSC-244, *Fracture-Control Guidelines for Welded Steel Ship Hulls* by S. T. Rolfe, D. M. Rhea, and B. O. Kuzmanovic. 1974. AD-A 004553.
- SSC-245, *A Guide for Inspection of High-Strength Steel Weldments* by The Weld Flaw Evaluation Committee. (To be published)
- SSC-246, *Theoretical Estimates of Wave Loads On The SL-7 Containership In Regular and Irregular Seas* by P. Kaplan, T. P. Sargent, and J. Cilmi. 1974. AD-A 004554.
- SSC-247, *Flame Straightening Quenched-And-Tempered Steels in Ship Construction* by R. L. Rothman. 1974. AD-A 002621.
- SSC-248, *Fracture Toughness Characterization of Shipbuilding Steels* by J. R. Hawthorne and F. J. Loss. 1975. AD 785034.
- SSC-249, *Ship-Vibration Prediction Methods and Evaluation of Influence of Hull Stiffness Variation on Vibratory Response* by R. G. Kline and J. C. Daidola. 1975. AD-A 008388.
- SSC-250, *Bibliography to Ship-Vibration Prediction Methods and Evaluation of Influence of Hull Stiffness Variation on Vibratory Response* by R. G. Kline and J. C. Daidola. 1975. AD-A 008387.
- SSC-251, *A Study of Subcritical Crack Growth In Ship Steels* by P. H. Francis, J. Lankford, Jr., and F. F. Lyle, Jr. 1975. AD-A 013970.

SL-7 PUBLICATIONS TO DATE

- SL-7-1, (SSC-238) - *Design and Installation of a Ship Response Instrumentation System Aboard the SL-7 Class Containership S.S. SEA-LAND McLEAN* by R. A. Fain. 1974. AD 780090.
- SL-7-2, (SSC-239) - *Wave Loads in a Model of the SL-7 Containership Running at Oblique Headings in Regular Waves* by J. F. Dalzell and M. J. Chiocco. 1974. AD 780065.
- SL-7-3, (SSC-243) - *Structural Analysis of SL-7 Containership Under Combined Loading of Vertical, Lateral and Torsional Moments Using Finite Element Techniques* by A. M. Elbatouti, D. Liu, and H. Y. Jan. 1974. AD-A 002620.
- SL-7-4, (SSC-246), *Theoretical Estimates of Wave Loads On The SL-7 Containership in Regular and Irregular Seas* by P. Kaplan, T. P. Sargent, and J. Cilmi. 1974. AD-A 004554.