

SSC-306

**EXPERIMENTAL PROGRAM
FOR THE DETERMINATION
OF HULL STRUCTURAL
DAMPING COEFFICIENTS**



This document has been approved
for public release and sale; its
distribution is unlimited.

SHIP STRUCTURE COMMITTEE

1981

SHIP STRUCTURE COMMITTEE

The SHIP STRUCTURE COMMITTEE is constituted to prosecute a research program to improve the hull structures of ships and other marine structures by an extension of knowledge pertaining to design, materials and methods of construction.

RAAdm Clyde T. Lusk, Jr. (Chairman)
Chief, Office of Merchant Marine
Safety
U. S. Coast Guard Headquarters

Mr. J. Gross
Deputy Assistant Administrator for
Commercial Development
Maritime Administration

Mr. P. M. Palermo
Executive Director
Ship Design & Integration
Directorate
Naval Sea Systems Command

Mr. J. B. Gregory
Chief, Research & Development Staff
of Planning & Assessment
U.S. Geological Survey

Mr. W. N. Hannan
Vice President
American Bureau of Shipping

Mr. Thomas W. Allen
Chief Engineering Officer
Military Sealift Command

LCdr D. B. Anderson, U.S. Coast Guard (Secretary)

SHIP STRUCTURE SUBCOMMITTEE

The SHIP STRUCTURE SUBCOMMITTEE acts for the Ship Structure Committee on technical matters by providing technical coordination for the determination of goals and objectives of the program, and by evaluating and interpreting the results in terms of structural design, construction and operation.

U. S. COAST GUARD

Capt. R. L. Brown
Cdr. J. C. Card
Mr. R. E. Williams
Cdr. J. A. Sanial

MILITARY SEALIFT COMMAND

Mr. Albert Attermeyer
Mr. T. W. Chapman
Mr. A. B. Stavovy
Mr. D. Stein

NAVAL SEA SYSTEMS COMMAND

Mr. R. Chiu
Mr. J. B. O'Brien
Mr. W. C. Sandberg
Lcdr D. W. Whiddon
Mr. T. Nomura (Contracts Admin.)

AMERICAN BUREAU OF SHIPPING

Dr. D. Liu
Mr. I. L. Stern

MARITIME ADMINISTRATION

Mr. N. O. Hammer
Dr. W. M. Maclean
Mr. F. Seibold
Mr. M. Touma

U. S. GEOLOGICAL SURVEY

Mr. R. Giangerelli
Mr. Charles Smith

NATIONAL ACADEMY OF SCIENCES SHIP RESEARCH COMMITTEE

Mr. A. Dudley Haff - Liaison
Mr. R. W. Rumke - Liaison

INTERNATIONAL SHIP STRUCTURES CONGRESS

Mr. S. G. Stiansen - Liaison

SOCIETY OF NAVAL ARCHITECTS & MARINE ENGINEERS

Mr. A. B. Stavovy - Liaison

AMERICAN IRON & STEEL INSTITUTE

Mr. R. H. Sterne - Liaison

WELDING RESEARCH COUNCIL

Mr. K. H. Koopman - Liaison

STATE UNIV. OF NEW YORK MARITIME COLLEGE

Dr. W. R. Porter - Liaison

U. S. COAST GUARD ACADEMY

LCdr R. G. Vorthman - Liaison

U. S. NAVAL ACADEMY

Dr. R. Battacharyya - Liaison

U. S. MERCHANT MARINE ACADEMY

Dr. Chin-Bea Kin - Liaison

Member Agencies:

*United States Coast Guard
Naval Sea Systems Command
Military Sealift Command
Maritime Administration
United States Geological Survey
American Bureau of Shipping*



An Interagency Advisory Committee
Dedicated to Improving the Structure of Ships

Address Correspondence to:

Secretary, Ship Structure Committee
U.S. Coast Guard Headquarters, (G-M/TP 13)
Washington, D.C. 20593

SR-1261

1981

Increases in ship propulsive power and the advent of deep draft bulk carriers have created numerous instances of unacceptable ship structural vibration. Two troublesome areas in response analysis are the prediction of magnitude and phasing of exciting forces, and the structural damping characteristics of the hull. For predicting the vibratory response of the hull girder and local structure, a determination of the total damping coefficient, including hydrodynamic, structural, and cargo damping components is needed.

The Ship Structure Committee sponsored a project directed toward collecting and evaluating structural damping data applicable to ship vibration analysis, and developing an experimental program, model or full scale, to extend and verify the design data. This report describes the result of that effort.

A handwritten signature in black ink, appearing to read "Clyde T. Lusk, Jr.", is positioned above the typed name.

Clyde T. Lusk, Jr.
Rear Admiral, U.S. Coast Guard
Chairman, Ship Structure Committee

1. Report No. SSC-306		2. Government Accession No.		3. Recipient's Catalog No.	
4. Title and Subtitle EXPERIMENTAL PROGRAM FOR THE DETERMINATION OF HULL STRUCTURAL DAMPING COEFFICIENTS				5. Report Date September 1981	
				6. Performing Organization Code	
7. Author(s) Pin Yu Chang and Thomas P. Carroll				8. Performing Organization Report No. SR-1261	
9. Performing Organization Name and Address CARROLL ASSOCIATES 7910 Woodmont Avenue, #1012 Bethesda, MD 20814				10. Work Unit No. (TRAIS)	
				11. Contract or Grant No. DOT-CG-824267-A	
12. Sponsoring Agency Name and Address U.S. Coast Guard Office of Merchant Marine Safety Washington, D.C. 20593				13. Type of Report and Period Covered Final Report	
				14. Sponsoring Agency Code G-M	
15. Supplementary Notes The USCG acts as the contracting agency for the Ship Structure Committee.					
16. Abstract A program of full-scale and model experiments for the determination of hull damping coefficients is outlined. A literature survey discusses available data for ship vibration damping, and assesses analytical and experimental techniques used in the past. Existing ship damping data have proven to be inadequate for making reliable vibration predictions. A scheme is discussed for experimentally isolating the damping coefficients associated with each important mode of vibration, as well as the breakdown of the total damping into its separate components (structural, cargo, and hydrodynamic), and the determination of the distribution of the damping along the ship. Excitation devices and analytical methods for reducing the experimental data are discussed, along with specific application to two ships (a 74,000 ton Great Lakes ore carrier, and a 30,000 ton container ship).					
17. Key Words Damping Hull vibrations Vibration testing Structural testing			18. Distribution Statement Document is available to the public through the National Technical Information Service, Springfield, VA 22161		
19. Security Classif. (of this report) UNCLASSIFIED		20. Security Classif. (of this page) UNCLASSIFIED		21. No. of Pages 83	22. Price

METRIC CONVERSION FACTORS

Approximate Conversions to Metric Measures

Symbol	When You Know	Multiply by	To Find	Symbol
LENGTH				
in	inches	2.5	centimeters	cm
ft	feet	30	centimeters	cm
yd	yards	0.9	meters	m
mi	miles	1.6	kilometers	km
AREA				
in ²	square inches	6.5	square centimeters	cm ²
ft ²	square feet	0.09	square meters	m ²
yd ²	square yards	0.8	square meters	m ²
mi ²	square miles	2.6	square kilometers	km ²
	acres	0.4	hectares	ha
MASS (weight)				
oz	ounces	28	grams	g
lb	pounds	0.45	kilograms	kg
	short tons (2000 lb)	0.9	tonnes	t
VOLUME				
tsp	teaspoons	5	milliliters	ml
Tbsp	tablespoons	15	milliliters	ml
fl oz	fluid ounces	30	milliliters	ml
c	cups	0.24	liters	l
pt	pints	0.47	liters	l
qt	quarts	0.95	liters	l
gal	gallons	3.8	liters	l
ft ³	cubic feet	0.03	cubic meters	m ³
yd ³	cubic yards	0.76	cubic meters	m ³
TEMPERATURE (exact)				
°F	Fahrenheit temperature	5/9 (after subtracting 32)	Celsius temperature	°C

*1 in = 2.54 (exactly). For other exact conversions and more detailed tables, see NBS Misc. Publ. 286, Units of Weights and Measures, Price \$2.25, SD Catalog No. C13.10.286.

Approximate Conversions from Metric Measures

Symbol	When You Know	Multiply by	To Find	Symbol
LENGTH				
mm	millimeters	0.04	inches	in
cm	centimeters	0.4	inches	in
m	meters	3.3	feet	ft
m	meters	1.1	yards	yd
km	kilometers	0.6	miles	mi
AREA				
cm ²	square centimeters	0.16	square inches	in ²
m ²	square meters	1.2	square yards	yd ²
km ²	square kilometers	0.4	square miles	mi ²
ha	hectares (10,000 m ²)	2.5	acres	ac
MASS (weight)				
g	grams	0.035	ounces	oz
kg	kilograms	2.2	pounds	lb
t	tonnes (1000 kg)	1.1	short tons	st
VOLUME				
ml	milliliters	0.03	fluid ounces	fl oz
l	liters	2.1	pints	pt
l	liters	1.06	quarts	qt
l	liters	0.26	gallons	gal
m ³	cubic meters	35	cubic feet	ft ³
m ³	cubic meters	1.3	cubic yards	yd ³
TEMPERATURE (exact)				
°C	Celsius temperature	9/5 (then add 32)	Fahrenheit temperature	°F

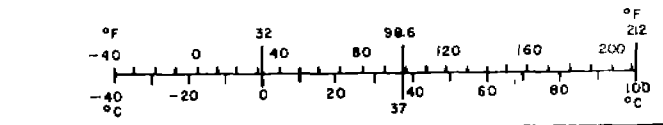

CONTENTS

1.0	Introduction.....	1
1.1	Review of Available Data for Ship Vibration Damping..	1
1.1.1	Cargo Damping.....	3
1.1.1.1	Full-Scale Data.....	3
1.1.1.2	Model Test Data.....	4
1.1.1.3	Conclusion.....	7
1.1.2	Hydrodynamic Damping.....	7
1.2	Review of Methods for Determining Ship Vibration Damping Characteristics.....	8
1.2.1	Transient Methods.....	9
1.2.2	Resonance Methods.....	9
1.2.2.1	Energy Technique.....	10
1.2.2.2	Magnification Factor Technique.....	10
1.2.3	Other General Shortcomings of Past Damping Experiments.....	10
1.3	Objectives.....	11
1.3.1	General Objectives.....	11
1.3.2	Particular Objectives.....	13
1.4	Summary.....	14
2.0	Ship Vibration Theory and the Effects of Damping.....	15
2.1	Review of the Existing Theory of Ship Vibrations.....	15
2.1.1	Solution of the Ship Vibration Problem.....	18
2.1.1.1	Free Vibration.....	18
2.1.1.2	Forced Vibration Steady State.....	19
2.1.1.3	Transient or Non-Harmonic Vibration.....	20
2.1.2	The Theoretical Basis of Transient Damping Testing.....	21
2.1.3	The Theoretical Basis of the Magnification Damping Tests.....	22
2.1.4	The Distribution of the Damping Coefficients.....	22
2.2	Components of Ship Vibration Damping.....	23
2.2.1	Structural Damping.....	23
2.2.1.1	Viscous Type of Structural Damping.....	23
2.2.1.2	Kelvin-Voight Type of Structural Damping....	24
2.2.2	Hydrodynamic Damping.....	26
2.2.3	Effects of Forward Speed on Damping.....	26
2.2.4	Cargo Damping.....	26
2.3	Effects of Damping on the Vibration Response of Ships.....	26
3.0	Plan for Experimental Determination of the Damping Components.....	28

3.1	The Importance of Theoretical Guidance.....	28
3.2	Objectives of the Experiments.....	29
3.3	Recommended Test Program.....	30
3.3.1	Rigid Model Experiments.....	30
3.3.2	Flexible Model Experiments.....	30
3.3.3	Full-Scale Experiments.....	30
3.3.4	Summary of Recommended Experiments.....	31
3.4	Methods for the Determination of the Damping Coefficients.....	31
3.4.1	Displacement Method.....	31
3.4.2	Bending Moment Method.....	32
3.4.3	Required Measurements.....	33
3.4.4	Method of Excitation.....	34
3.5	Model Tests.....	35
3.5.1	Segmented Models.....	36
3.5.2	Vinyl Models.....	36
3.5.3	The Scale of the Model.....	36
3.5.4	Mechanics and Mechanisms of the Test Models.....	37
3.5.5	Flexible Model Experiments.....	40
3.5.5.1	Experiments in Air with Flexible Model.....	40
3.5.5.2	Experiments in Water with Flexible Model....	40
3.5.5.3	Experiments in Water with Forward Speed....	40
3.5.6	Rigid-Hull Model Experiments.....	41
3.6	Correlation Between the Analytical and Experimental Results.....	41
3.6.1	Effects of the Depth of Water.....	42
3.6.2	Effects of the Material Properties.....	42
3.6.3	Effects of the Excitation.....	42
3.6.4	Effects of the Responses of the Local Structural Elements.....	47
3.6.5	Desirable Correlations.....	47
3.7	Full-Scale Damping Experiments.....	48
3.7.1	Recommended Full-Scale Tests.....	48
3.7.2	Required Excitation.....	49
3.7.3	Excitation Devices.....	50
3.7.3.1	Rotating Mass Vibration Generators.....	50
3.7.3.2	Electrohydraulic Vibration Generators.....	52
3.7.3.3	Electrodynamic Vibration Generators.....	58
3.7.4	Installation of Excitation Devices on Ships.....	58
3.7.4.1	Structural Requirements.....	59
3.7.4.2	Space and Weight Considerations.....	61
3.7.4.3	Effect of Response of Local Structure.....	61
3.7.5	Location and Magnitude of the Excitation....	61
3.7.6	Response Calculations and Required Measurements.....	64
3.7.7	Test Program.....	64

4.0	Summary.....	65
5.0	References.....	67

Appendix A

LIST OF FIGURES

Fig. 1-1	Damping Coefficients Used by Various Investigators
Fig. 2-1	Coordinate System
Fig. 3-1	M/V STEWART J. CORT
Fig. 3-2	Effect of Water Depth on First Mode Frequency of Ship Model
Fig. 3-3	Effect of Water Depth on Second Mode Frequency of Ship Model
Fig. 3-4	Effect of Water Depth on the Damping of the First Mode Vertical Vibration of Ship Model
Fig. 3-5	Effects of Water Depth on the Damping of Second Mode Vertical Vibration of Ship Model
Fig. 3-6	Rotating Mass Vibration Generators Maximum Peak Dynamic Force Output vs. Frequency
Fig. 3-7	Hydraulic Actuator and Load Distribution Frame Used by Baldwin
Fig. 3-8	360 GMP Hydraulic Power Supply Unit
Fig. 3-9	Schematic of Electrohydraulic Vibration Excitation System Used During Dynamic Tests of a Highway Bridge
Fig. 3-10	Hydraulic Actuator and Load Distribution Frame of a 20k Electrohydraulic Actuator (at 1/3 Hz.)
Fig. 3-11	Approximate Location of Excitation Devices

LIST OF TABLES

Table 1-1	Effect of Cargo on Damping
Table 3-1	Scaling Relationships for Prototype and Model
Table 3-2	Principal Dimensions of the CORT
Table 3-3	The Principal Dimensions of the C6-S-85a

LIST OF SYMBOLS AND ABBREVIATIONS

A	Shear area of ship section
B	Beam of ship
B_i	Water plane area
b	Moment load
C	Damping coefficient associated with vertical motion
C_o	Damping coefficient associated with rotation
C_v	Viscous damping coefficient
C_k	Kelvin-Voight damping coefficient
D	Damping matrix
E	Modulus of elasticity
e	Base of natural logarithm
F	Vertical hydrodynamic force
G	Shear modulus of elasticity
g	Acceleration of gravity
I	Moment of inertia of the ship section
I_o	Mass (rotary) moment of inertia per unit length
I_a	Added mass (rotary) moment of inertia per unit length
K	Stiffness matrix
k_i	Spring stiffness
L	Length of ship
M	Bending moment
\bar{M}	Mass matrix
m_a	Added mass of water per unit length
m_s	Mass of ship per unit length
N	Hydrodynamic damping coefficient
P	Axial force
Q	Vertical excitation force
S	State variable vector (w, θ , M, V)
t	Time
U	Forward speed
V	Shear force
W_n	Peak deflection
w	Vertical displacement

x Coordinate variable along longitudinal center line
 Y Heaving displacement
 θ Elastic slope of ship axis
 ξ Water surface elevation relative to still water
 ρ Density of water
 ψ Pitching angle
 Ω Excitation frequency
 ω Natural frequency
 ω_n Natural frequency of n th mode
 \emptyset Phase angle
 τ Dummy variable for time

Primes denote differentiation with respect to position (x)
Dots denote differentiation with respect to time (t)



1.0 INTRODUCTION

Ship vibrations have historically been a problem to the maritime community. The trend toward larger ships, more flexible hulls, deeper draft and increased ship propulsive power has aggravated the problem. Ship vibrations are receiving increased attention in ship performance specifications.

Ship damping dominates any attempts to make predictions of the vibratory response of hulls. Three basic components contribute to hull damping; structural damping, hydrodynamic damping and cargo damping. Ship damping data, adequate for making reliable vibration predictions, do not exist. Previous experiments aimed at evaluating ship damping have not produced the needed data. The distribution of the damping throughout the ship as well as the breakdown of the damping into its three basic components (structural, hydrodynamic and cargo) has not historically been addressed.

Theoretically, all modes of vibration participate in the response of a ship to excitation. Response to shock loading is dominated by the first few lower modes, but response to cyclic disturbances, such as rotating machinery and wave-induced motions, is typically dominated by modes with frequencies which couple with the frequencies of excitation. Damping characteristics are different for different modes, and, therefore, damping coefficients for different modes are needed in order to make reliable vibration calculations. Past steady-state vibration tests have neglected this important factor. The approach presented in this report involves exciting the ship in such a manner that essentially only one mode at a time will participate in the response. Consequently, the damping coefficients for these modes can be accurately assessed. In addition, the approach presented involves determining the separate damping coefficients for structural, cargo and hydrodynamic damping, and the distribution of damping throughout the ship.

1.1 Review Of Available Data For Ship Vibration Damping

In the mid-1960's, Woolam (Reference 1-1) reviewed the state-of-the-art of vibration damping associated with ship hulls, and presented a categorized summary of available damping data based on ship class, type of hull framing, loading condition, mode number, and method of excitation. In Reference 1-1, damping coefficients are presented for vertical modes of vibration for the first five modes of vibration and separate tables are

Ref. 1-1: Woolam, W. E., "Research on Ship-Hull Damping Coefficients for Low-Frequency Vertical Flexural Modes of Vibration," Naval Ship Research & Development Center, Report 2323, May 1967.

presented for Cargo Ships, Tankers and Miscellaneous Ships. The damping coefficients given in Reference 1-1 are presented in terms of the equivalent frequency-dependent viscous-damping value most common to the maritime industry. This representation was first used by McGoldrick (Reference 1-2) and assumes that $C/\mu\omega = \text{constant}$, where C is the distributed viscous damping force per unit velocity per unit length, μ is the mass per unit length of hull including added mass of surrounding water, and ω is the circular frequency of vibration. A review of the tables in Reference 1-1 shows that this factor is not a constant.

Past vibration tests have involved a wide variety of experimental techniques to measure hull damping, and a variety of expressions for defining damping coefficients have evolved. The most commonly used descriptions for damping are presented below. The theoretical basis for these methods is discussed in succeeding sections of this report.

1. Equivalent viscous damping coefficient ($C/\mu\omega$)
2. Logarithmic decrement (δ)
3. Magnification factor (Q)
4. Amplification factor (A)
5. Damping ratio $\zeta = C/\text{critical damping} = C/C_c$
6. Dissipation factor (η)

The following cross relationships and conversions exist among these quantities:

$$C/\mu\omega = \delta/\pi = 2\zeta = 2C/C_c = 1/Q = 1/A = \eta \quad (1-1)$$

These relationships are based on linear single-degree-of-freedom systems.

Despite the apparent abundance of information presented in Reference 1-1, the information is inadequate for predicting the response of ships at resonant conditions. The main inadequacies stem from

1. the lack of differentiation of the basic damping components (i.e. hydrodynamic, cargo and structural damping)
2. the lack of information on the distribution of the damping along the ship

Ref. 1-2: McGoldrick, R. T., "Comparison Between Theoretically and Experimentally Determined Natural Frequencies and Modes of Vibration of Ships," DTMB Report 906, August 1954.

3. the frequency and mode dependency of damping coefficients are not being established, and
4. most measuring and computing methods being based on single-degree-of-freedom methods.

To date, we have been unable to find experimental data which overcome all of these deficiencies, but several sources which address some aspects of these problem areas are discussed briefly below.

1.1.1 Cargo Damping

The term "cargo" is used to include all the ship's contents other than fixed structures and equipment. The four major categories of interest are: (1) solid cargo, (2) loose dry cargo, (3) liquids, and (4) spring masses. Some researchers question whether spring masses should be included under the term "damping." According to McGoldrick (Reference 1-3), the most important source of damping appears to be cargo friction. Despite its apparent relevance to hull damping, no theoretical work could be found which deals with the energy dissipated by ship cargo. Some experimental data do exist on cargo damping, but the information is scanty and of questionable reliability and applicability. Cargo damping information derived from full-scale and model experiments are discussed below.

1.1.1.1 Full-Scale Data

Betts, Bishop and Price (Reference 1-4) have documented some circumstantial evidence concerning cargo damping in full-scale ships. The logarithmic decrement for the vertical bending modes were tabulated for various types of cargo, and the increase (in the logarithmic decrement) due to cargo damping was estimated (assuming that none of the increase is due to hydrodynamics). The logarithmic decrement data presented in Reference 1-4 have been converted to the damping coefficient $C/\mu\omega$ using the relationships of equation 1-1, and the data have been reformatted and are presented in Table 1-1. Most of the values are for the 2-node vertical bending modes, but there are also some values for the 3-node and 4-node modes.

Tomita (Reference 1-5) has suggested that general cargo

-
- Ref. 1-3: McGoldrick, R. T., "Comments on Some of the Fundamental Physical Concepts in Naval Architecture," DTMB Report 1609, April 1962.
- Ref. 1-4: Betts, C. V., Reid Bishop and W. G. Price, "A Survey of Internal Hull Damping," RINA, 1976.
- Ref. 1-5: Tomita, T., "Allowable Exciting Force or Moment of Diesel Marine Engine," Trans. SNAJ, Vol. 108, 1960 (see also Proc. 2nd ISSC (Committee 9), Delft, 1964).

increases hull logarithmic decrement by 0.02 in the 2-node bending modes. This represents an increase of about 100% on his measurements for the 2-node symmetric bending mode, but represents an increase of only about 20% in the commonly used value of $C/\mu\omega = 0.034$ presented by McGoldrick in Reference 1-2.

1.1.1.2 Model Test Data

Volcy (Reference 1-6) reported on a series of tests involving the use of a sheetmetal model representing a liquid cargo tanker or a dry cargo transporter. Tests were conducted with the model empty, as well as with the model loaded with water, and with sand. The model was approximately 9.85 ft. long and simulated a 200,000 metric ton ship at a scale factor of 1/100. The model was tested in air, in water, and with variable cargo (water, sand), and values of the damping were evaluated. An eccentric mass vibration generator was used to excite the model. Some of the results reported in Reference 1-6 are discussed below.

For the model in water, the damping values were practically the same for the empty model, as for the model filled with water. On the other hand, there was a large increase in the damping when the model was filled with sand. For the first mode the damping increased by a factor of 12 and for the higher modes increases as high as a factor of 20 were observed. In addition, redistributing the same cargo in different parts of the model produced damping variations of almost a factor of four. These observations should be treated cautiously due to possible scale effects, but they do indicate the importance of cargo damping, especially the importance of cargo friction, i.e. coulomb-type damping.

Yamamoto (Reference 1-7) measured damping of a simple free-free beam (in air) loaded in turn with pebbles, iron lumps, and sand. He showed that the damping was approximately doubled in each case for a 10% increase of the cargo. Betts (Reference 1-4) concluded that since Yamamoto's beam possessed structural damping an order of magnitude less than full-scale hulls, and natural frequencies an order of magnitude more, the probable effects of cargo damping on full-scale ships would be considerably less marked.

Ref. 1-6: Volcy, G. C., "L'Amortissement dans les Vibration des Navires," Nonveantes Techniques Maritime, 1978 (in French).

Ref. 1-7: Yamamoto, Y. and M. Arita, "Damping Forces in Ship Vibration," Trans. SNAJ, Vol. 118, 1965, p. 138.

Table 1-4 EFFECT OF CARGO ON DAMPING

Reference	Ship (Cargo)	Condition (dwt)	c/ μ w	Increase due to Cargo*	Comments
Taylor 1-22	Cargo Ship (general)	Part load (6550)	.006		Very crude result only
		Full load (12700)	.006	None	
Aertssen and de Lembre 1-23	218 m ore carrier (ore)	Ballast	.0117 (mean)		Within experimental scatter
		Loaded	.0124 (mean)	+ 5%	
Aertssen and de Lembre 1-24	146 m cargo liner (general)	Part load	.0204 (mean)		No change if ignore one high reading in full load condition
		Full load	.0226 (mean)	+ 11%	
Aertssen and de Lembre 1-24	128 m container ship	Normal (8 m draught)	.0140 (mean)		Comparability open to question by reason of differing weather and operating conditions.
		Deep (9 m draught)	.0207 (mean)	+ 48%	
Johnson 1-8	127 m riveted dry cargo ship (water ballast)	Light (7000)	.0146 (.0095)		Forced vibration (Free vibration)
		Deep (13270)	.0162 (.0130)	+ 11% (+ 38%)	

2-Node Mode

-5-

*Assuming none due to hydrodynamics.

Table 1-4 (continued)

Reference	Ship (Cargo)	Condition (dwt)	$c/\mu\omega$	Increase due to Cargo*	Comments	
Johnson 1-8	127 m welded dry cargo ship (water ballast)	Light (7500)	.0076		Within experimental scatter	2-Node Mode (cont'd)
		Deep (13500)	.0083	+ 8%		
McGoldrick and Russo 1-25	161 m dry cargo ship (general, including cars)	13750	.0140			3-Node Mode
		16840	.0366	+160%		
		13750	.0168			4-Node Mode
		16840	.0414	+145%		

- Ref. 1-22 Taylor, J. Lockwood, "Vibration of Ships," Trans. INA, Vol. 72, pp. 162-196, 1930.
- Ref. 1-23 Aertssen, G. and R. de Lembre, "Calculation and Measurement of the Vertical and Horizontal Vibration Frequencies of a Large Ore Carrier," Trans. NECIES, Vol. 86, pp. 9-12, 1970.
- Ref. 1-24 Aertssen, G. and R. de Lembre, "Hull Flexural Vibrations of the Container Ship DART EUROPE," Trans. NECIES, Vol. 90, pp. 19-26, 1974.
- Ref. 1-25 McGoldrick, R. T. and V. L. Russo, "Hull Vibration Investigation on SS GOPHER MARINER," DTMB Report 1060, July 1956.

Johnson (Reference 1-8) reported on experiments on large wooden models loaded with pig iron, sand and water, and observed no noticeable difference in the damping coefficients in the 2-node mode. Johnson claimed that the damping coefficient of his model was of the same order as that of a medium-size cargo ship.

1.1.1.3 Conclusion

Cargo damping may contribute significantly to hull damping but available test data, both full-scale and from model tests, fail to adequately answer questions, and in some cases raise questions about the importance of cargo damping.

1.1.2 Hydrodynamic Damping

The relative importance of hydrodynamic damping is not clear in the literature and few experiments have been conducted to answer the questions. Sezawa and Watanabe (Reference 1-9) have divided hydrodynamic damping into three main sources: (1) water friction, (2) generation of pressure waves, and (3) generation of surface waves. In the so-called rigid-body modes of a hull, hydrodynamic actions would seem to overwhelmingly predominate (Reference 1-4); but in hull-distortion modes, there seems to be a consensus among many researchers that hydrodynamic damping becomes less significant as structural and cargo damping come into play. Betts (Reference 1-10) reviewed available theoretical and experimental evidence and concluded that "generally speaking, all forms of hydrodynamic damping are negligible in the higher modes of conventional ships." Robinson (Reference 1-11) also states that "the least important source of damping at low hull frequencies appears to be that due to water." Kumai (Reference 1-12)

-
- Ref. 1-8: Johnson, A. J., "Vibration Tests of an all-welded and all-riveted 10,000 ton Dry Cargo Ship," Trans. NECLIS, Vol. 67, 1951, pp. 205-276.
- Ref. 1-9: Sezawa, K. and W. Watanabe, "Damping Forces in Vibration of a Ship," Journal of Society of Naval Architects, Japan, No. 59, 1936.
- Ref. 1-10: Betts, C. V., "On the Damping of Ship Hulls," M. Phil. Thesis, London University, 1975.
- Ref. 1-11: Robinson, D. C., "Damping Characteristics of Ships in Vertical Flexure and Considerations in Hull Damping Investigation," DTMB Report 1876, December 1964.
- Ref. 1-12: Kumai, T., "Damping Factors in the Higher Modes of Ship Vibration," European Shipbuilding, Vol. VII, No. 1, 1968.

also estimates that the total energy loss due to hydrodynamic damping is negligible compared with the loss due to structural damping. Borg (Reference 1-13) made energy calculations for a ship vibrating in the 2-node vertical mode following ship slamming, and concluded that the energy loss due to internal hull friction is many orders of magnitude greater than hydrodynamic energy absorption. Volcy (Reference 1-6) conducted tests on a 1/100 scale model of a tanker (previously described in section 1.1.1.2) and measured damping for the model in air, and in water. He reported that there was not a significant variation of the damping coefficient for the model in air, and in water, for the model either empty or filled with water. (The model response was in the 2-node vertical mode.)

In recent years, ships have been built with increasing hull flexibility, and hydrodynamic damping may play a more important role in hull vibrations than previously thought. The forward-speed effect on hull vibration has been recognized by Salvensen et al. (Reference 1-14). In the past, no damping experiments have been conducted to determine the effect of forward-speed on damping. In fact, Goodman has developed a method for studying wave-excited hull vibrations in large tankers and bulk carriers (Reference 1-15) and suggests that speed-dependent (hydrodynamic) damping is the predominant source of damping for a large tanker at service speed.

In light of the above discussion, it is apparent that more information is needed on the effects of hydrodynamic damping and forward-speed on the damping of hull vibrations.

1.2 Review Of Methods For Determining Ship Vibration Damping Characteristics

The state of the art of vibration damping has been reviewed in detail by Woolam (Reference 1-1). In general, past damping experiments can be grouped into two categories: resonance methods and transient methods. All previous methods, according to Reference 1-1, have certain shortcomings and limitations and the resulting data are inadequate for predicting the response

-
- Ref. 1-13: Borg, S. F., "The Analysis of Ship Structures Subjected to Slamming Loads," Journal of Ship Research, 4, No. 3, pp. 11-27, 1960.
- Ref. 1-14: Salvesen, N., E. O. Tuck and O. Faltinsen, "Ship Motions and Sea Loads," Transactions SNAME, 1970.
- Ref. 1-15: Goodman, R. A., "Wave-Excited Main Hull Vibration in Large Tankers and Bulk Carriers," RINA, 1971.

of ship hulls at resonant conditions. The limitations and shortcomings discussed in Reference 1-1 are not repeated here, but some important difficulties, which have not previously been discussed, are presented.

1.2.1 Transient Methods

Transient methods, in general, are based on the measurement of the decay of the free vibrations of the ship. The theoretical background for these methods is presented in Section 2.1.5. Several practical aspects are discussed in References 1-16, 1-17 and 1-18.

The main shortcomings of these methods, in addition to those indicated by Woolam, are the following:

1. For large commercial ships, the excitation used in past experiments has been inadequate to generate measurable response.
2. The coupling of the modes, due to damping, makes it difficult to separate the contributions of the significant modes of vibration (this is especially true in cases where the frequencies are close together).
3. The measured responses include components from many modes and it is difficult to separate the effects of local structural response and the effects of the excitation device from the hull girder response.

1.2.2 Resonance Methods

Resonance methods, in general, attempt to measure the steady-state vibration of ships at resonant conditions. Under resonant conditions, a relatively small excitation can generate much greater response than those generated by transient methods. The damping coefficient can be determined by the following techniques.

-
- Ref. 1-16: Beals, V. L. and S. R. Hurley, "The Application of Impulsive Excitation to In-Flight Vibration Testing," Aerospace Engineering 20, No. 1, January 1961.
- Ref. 1-17: Buchanan, E. and R. G. Ruckerman, "Model Basin Procedure for the Analysis and Presentation of Vibration Data," Shock, Vibration and Associated Environments. Bulletin No. 33, February 1964.
- Ref. 1-18: Foster, W. P. and H. F. Alma, "Damping Values of Naval Ships Obtained from Impulse Loadings," Shock and Vibration Bul. #40, December 1969.

1.2.2.1 Energy Technique

In the absence of damping, once a system is excited and set into motion the motions will theoretically continue indefinitely. As a consequence of damping, some energy is dissipated, and a continuous source of energy is required to maintain these motions. In the steady state, the energy generated by the excitation is, therefore, equal to the energy dissipated.

One of the difficulties of this approach is that the dissipated energy so determined is the energy dissipated by the whole system, not just the system we want to measure. For model tests, this total energy also includes the energy dissipated by the exciters, the supports and the foundations. Energy dissipation by the exciters and local structural response is also a problem in full-scale testing.

1.2.2.2 'Magnification Factor Technique

The theoretical basis for this method is given in Section 2.1.6. Woolam (Reference 1-1) has indicated that it is necessary to also measure the static displacement under a static force of the same magnitude. This is not necessary since the static displacement (or moment) can be calculated using standard methods.

The main difficulty of this method is that in order to excite the ship in a particular mode of vibration while suppressing all other modes, it is necessary to use more than one exciter. In fact, as indicated in the following sections, at least five exciters are required.

1.2.3 Other General Shortcomings Of Past Damping Experiments

Many measuring and computing methods treat the ship as a single damped mass-spring system. The results, even if accurate, provide the total damping of the ship. While such data are abundant and readily available, they are not adequate for ship vibration analysis.

The measurements obtained in damping experiments provide only the total response due to certain controlled excitations. It is generally understood that the total damping consists of at least three basic components, i.e. hydrodynamic, cargo and structural damping, and that these components, and the effects of different frequencies, an experimental program must include methods for differentiating among these components. Little effort has been made in this direction in past experiments.

In order to make accurate and reliable ship vibration calculations, in addition to the magnitude, the distribution of the damping coefficients along the ship is required. None of the existing experimental data and computation methods can be used to determine the distribution of the damping.

The forward-speed effects have been recognized as being quite important (Reference 1-19). In the past, no damping experiments have been conducted to determine the forward-speed effects on damping. Hoffman (Reference 1-20) has calculated the differences between the experimental results and the results in Goodman's method (Reference 1-21), and he indicated the importance of the forward-speed effects. However, he attributed these differences to the damping alone. Since Goodman's solution also ignores the forward-speed effects on the hydrodynamic force and the stiffness of the hull, the actual forward-speed effects of damping are still unknown.

The current indeterminate status of damping can be seen in Figure 1-1. Various investigators use entirely different values of the damping coefficient. Note that almost, if not all, of these experimental data were measured with the ships stationary.

1.3 Objectives

1.3.1 General Objectives

It is not enough to provide the theorists with a bundle of data. The data must be in the form and domain of interest to the users; otherwise, the usefulness of the data is greatly diminished. In other words, experiments must be orientated to the users (the theorists and analysts) not the experimentalists. Unless the measurements are geared to the needs of the theory, the data may be useless. This is particularly true in this project since the damping coefficient cannot be measured directly but must be deduced from the measured responses.

In order to assure the usefulness of the experimental data, the following general objectives must be achieved.

1. The experiments must be closely guided by ship vibration theory.
2. The data must be complete and the experimental conditions must be recorded and presented as part of the data. Completeness requires that all factors related to the data must be measured

Ref. 1-19: Salvesen, N., E. O. Tuck and O. Faltinsen, "Ship Motions and Sea Loads," Trans. SNAME, 1971.

Ref. 1-20: Hoffman, D., et al., "Experimental and Theoretical Evaluation of Springing on a Great Lakes Bulk Carrier," AD-776861, July 1973.

Ref. 1-21: Goodman, R. A., "Wave-Excited Main Hull Vibration in Large Tankers and Bulk Carriers," RINA, 1971.

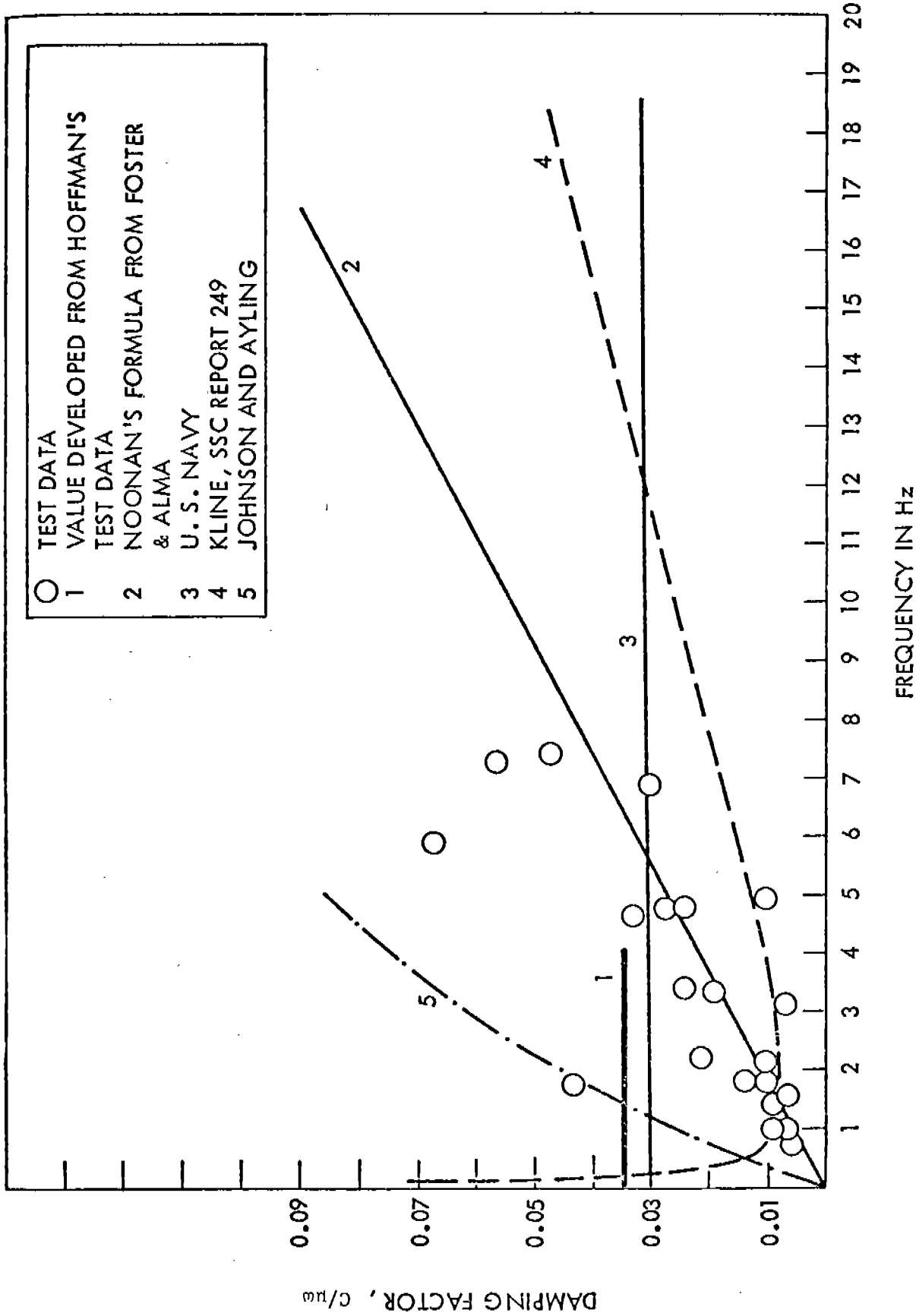

Figure 1-1 DAMPING COEFFICIENTS USED BY VARIOUS INVESTIGATORS

and recorded. For the damping experiments, this includes at least the following:

- a. Complete loading conditions at every measurement, the weight and buoyancy curves and other pertinent data such as draft marks, etc. are required.
 - b. The complete time histories of bending moment and acceleration must be measured and recorded.
 - c. The dynamic characteristics of the exciters, the supports and the supporting ship structural members must be accurately described, analyzed and presented with the data.
 - d. Calibration conditions and methods must be described and recorded in detail including the weight and buoyancy curves, draft marks, etc.
3. The reliability of the measurements depends on the consistency of the data.

The measurement of ship vibration responses is a complicated and difficult task. Despite the careful planning and implementation, there are still many intangibles involved. An experiment without a checking or validation scheme cannot be regarded as reliable. The best way to check the reliability of the data is to have measurements which can check each other. If consistent results can be obtained from these measurements, the reliability of the measurements is assured.

1.3.2 Particular Objectives

The main objective of the damping experiment is to obtain adequate and reliable data from which the damping coefficients used for the prediction of ship vibration response can be determined. In order to achieve this particular objective, the following objectives must be achieved:

- a) The sources of damping must be isolated so that the contribution of the following damping components can be determined:
 - ° Structural damping
 - ° Hydrodynamic damping
 - ° Cargo damping
 - ° Additional damping due to forward speed
- b) The dependency of the damping components on the excitation frequency must be determined. It is well known that vibration damping is a function of vibration frequency. The effects of the frequency on the above damping components must be determined.

- c) The distribution of the damping components along the ship must be determined.

The equations of motions of the ship vibration require both the distribution and magnitude of the damping coefficients along the length. It is necessary to determine the damping distribution along the length of the ship.

1.4 Summary

It has been shown that existing ship damping data are inadequate for making reliable ship vibration calculations, and the major shortcomings of past damping experiments have been examined. It has been established that to obtain the needed damping data, experiments must be conducted which are closely guided by ship vibration theory. A discussion of the ship vibrations theory is presented in Section 2, with particular emphasis on damping measurements and the effects of damping on hull response. Guided by this, an experimental program for the determination of needed damping data is outlined in Section 3.

2.0 SHIP VIBRATION THEORY AND THE EFFECTS OF DAMPING

The theoretical basis of the experimental program for the determination of hull structural damping coefficients is developed in this section. The basic equations of motion are presented and examined in the light of the planned experiments. The importance of forward speed on the experimental determination of damping coefficients is discussed. The mathematical basis for determining the excitation which will produce the desired "single-mode" response is presented, along with the analytical basis for obtaining the desired damping coefficients from the test measurements.

2.1 Review Of The Existing Theory Of Ship Vibrations

It has been commonly accepted that the vertical vibration of ships can be treated as the vibration of a non-uniform free-free beam. The general differential equation of motion can be expressed as follows:

$$\begin{aligned}w' &= -\theta + \frac{V}{GA} \\ \theta' &= \frac{M}{EI} \\ M' &= V + P\theta + I_0\dot{\theta} + C_0\dot{\theta} \\ V' &= m_s\ddot{w} + C\dot{w} - F(w,\xi,x,t) - Q(x,t)\end{aligned}\tag{2-1}$$

where

w, θ, M, V are the deflection, slope, bending moment, and shear responses of the hull, respectively.

P is the axial force.

I_0 is the mass rotary moment of inertia/length.

I is the moment of inertia of the ship section.

C_0 and C are the damping coefficients per unit length associated with the rotation and vertical motions of the ship section.

m_s is the ship mass/length.

A is the shear area.

$F(w,\xi,x,t)$ is the vertical hydrodynamic force.

$Q(x,t)$ is the vertical excitation force.

ξ is the wave profile (water surface height relative to still water).

G is the shear modulus of elasticity.

E is the modulus of elasticity.

x is the position variable along the longitudinal axis of the ship.

t is time.

primes denote differentiation with respect to position ($\partial/\partial x$).

dots denote differentiation with respect to time ($\partial/\partial t$).

Other formulations of the ship vibration problem have been used by various investigators (References 2-1, 2-2, 2-3 and 2-4). A comparison among these methods is presented in Reference 2-11.

The expression for the wave excitation force $F(w, \xi, x, t)$ involves some uncertainties. In general, these forces are characterized by certain hydrodynamic coefficients such as various damping and added mass coefficients. There are many methods available for the calculation of these coefficients; however, a general discussion of all these methods is beyond the scope of this project. In summary, it has been proven that the two-dimensional conformal mapping method for added mass and damping coefficients is quite accurate for most of the common ship sections. This method is not as accurate toward the stern and bow of the ship because of the three-dimensional effects and because of the particular shapes. Since the changes of the hydrodynamic coefficients are greatest toward the bow and the stern, a more accurate method is required for determining these hydrodynamic coefficients.

Our concern in this project is not, however, to develop these methods but to generate reliable experimental data. At present, different experts also have different expressions for some of the hydrodynamic coefficients. Faltinsen (Reference 2-5)

-
- Ref. 2-1: Noonan, E. F., "Design Considerations for Shipboard Vibration," presented at the Feb. 17, 1970 meeting of the New York Section of SNAME.
- Ref. 2-2: Kline, R., "Springing and Hydroelastic Problems of Large Ships," August 26-29, 1975, SNAME.
- Ref. 2-3: McGoldrick, R. T., "Ship Vibration," DTNSRDC Report 1451, December 1960.
- Ref. 2-4: Stiansen, S. G., A. Mansour and Y. N. Chen, "Dynamic Response of Large Great Lakes Bulk Carriers to Wave-Excited Loads," Transactions of SNAME, 1977.
- Ref. 2-5: Faltinsen, O. M., "A Numerical Investigation of the Ogilvie-Tuck Formulas for Added-Mass and Damping Coefficients," Journal of Ship Research, June 1974.
- Ref. 2-11: Chang, P. Y., "The Effects of Varying Ship Hull Proportions and Hull Materials Vibratory Stresses," Hydronautics, Inc., TR7715-1, Sept. 1978, SSC-288, 1979.

has compared the hydrodynamic coefficients used by Korvin-Kroukovsky (Reference 2-6) and Jacobs, Salvesen, Tuck, Faltinsen (Reference 2-7), and those by Ogilvie and Tuck (Reference 2-8).

In general, the excitation force of the surrounding water (per unit length) can be expressed as:

$$F(w, \xi, x, t) = - \frac{D}{Dt} m_a \frac{D}{Dt} (w - \xi) - \frac{N}{\omega_n^2} \frac{D}{Dt} (\dot{w} - \dot{\xi}) - \rho g B (w - \xi) \quad (2-2)$$

$$\frac{D}{Dt} = \frac{\partial}{\partial t} - U \frac{\partial}{\partial x}$$

where

m_a is the added mass/length.

U is the forward speed.

N is the hydrodynamic damping coefficient.

w is the deflection of the ship.

ξ is the water surface height relative to still water.

B is the beam of the ship.

ρ is the density of the water.

ω_n is the natural frequency of the ship.

g is the acceleration due to gravity.

This expression simply states that the excitation consists of the inertia force (first term in brackets), the damping force (second term in brackets), and the restoring force. All of these force components are functions of the relative position between the water surface and the ship section.

The general solution of the first order equations 2-1 has been given in detail in References 2-4 and 2-10. In general, equations 2-1 and 2-2 can be combined into the following matrix equation:

-
- Ref. 2-6: Korvin-Kroukovsky, V. V. and W. R. Jacobs, "Pitching and Heaving Motions of a Ship in Regular Waves," Transactions of SNAME, Vol. 65, 1957.
- Ref. 2-7: Salvesen, N., E. O. Tuck and O. Faltinsen, "Ship Motions and Sea Loads," Transactions SNAME, 1971.
- Ref. 2-8: Ogilvie, T. F. and E. O. Tuck, "A Rational Strip-Theory of Ship Motion - Part I," The University of Michigan, Report No. 013, 1969.
- Ref. 2-10: Chang, P. Y., "Structural Analysis of Cold Water Pipes for Ocean Thermal Energy Conversion Power Plants," Hydronautics, Inc., TR No. 7676, May 1977.

$$S' = KS + \overline{M}\ddot{S} + D\dot{S} + Q \quad (2-3)$$

where

$S = w, \theta, M, V$ is the state variable vector.

$$\dot{S} = \frac{\partial S}{\partial t}, \quad S' = \frac{\partial S}{\partial x}, \quad \ddot{S} = \frac{\partial^2 S}{\partial t^2}$$

K, \overline{M}, D are the stiffness, mass, and damping matrices, respectively.

Q is the excitation vector.

$$Q = \left\{ \begin{array}{cccc} 0 & 0 & b(x,t) & f(x,t) \end{array} \right\}$$

$b(x,t)$ is the moment load.

$f(x,t)$ is the force load.

For problems in the frequency domain:

$$b(x,t) = b_c(x)\cos\Omega t + b_s(x)\sin\Omega t$$

$$f(x,t) = f_c(x)\cos\Omega t + f_s(x)\sin\Omega t$$

Ω is the excitation frequencies.

2.1.1 Solution Of The Ship Vibration Problem

2.1.1.1 Free Vibration - Omitting the damping and excitation force terms in equation 2-3 produces the equation for undamped free vibrations.

$$S' = KS + \overline{M}\ddot{S} \quad (2-4)$$

Assuming harmonic vibrations of frequency ω , such that

$$S = S_0 \sin \omega t$$

Equation 2-4 becomes:

$$S' = (K - M\omega^2)S \quad (2-5)$$

Solution of equation 2-5 provides an infinite set of eigenvalues and eigenvectors, ω_n and S_n which satisfy the given boundary conditions and the conditions:

$$S'_n = (K - \overline{M}\omega_n^2)S_n \quad (2-6)$$

Where ω_n and $S_n(x)$ are the natural frequency and mode shape for the n mode and for the given boundary conditions. Methods for the solution of S_n have been given in detail in Reference 2-9.

Ref. 2-9: Pilkey, W. D. and P. Y. Chang, "Modern Formulas for Statics and Dynamics -- A Stress-and-Strain Approach," McGraw-Hill Book Company, 1978.

2.1.1.2 Forced Vibration Steady State - Assuming a solution of the form

$$S(x,t) = \sum A_n S_n(x) \cos(\omega t - \theta_n) \quad (2-7)$$

in which θ_n is the phase angle, and substituting equation 2-7 into 2-3 and using the relation of equation 2-6 yields:

$$\begin{aligned} \sum A_n (\omega_n^2 - \omega^2) \bar{M} S_n \cos(\omega t - \theta_n) - \sum A_n \omega D S_n \sin(\omega t - \theta_n) \\ = Q_C \cos \omega t + Q_S \sin \omega t \end{aligned} \quad (2-8)$$

where

$$\begin{aligned} Q_C &= \{ 0, 0, b_C, f_C \} \\ Q_S &= \{ 0, 0, b_S, f_S \} \end{aligned}$$

Equation 2-8 represents a set of four simultaneous equations. Multiplying the third equation of 2-8 by θ_m and the fourth equation of 2-8 by w_m and integrating over the whole length of the ship yields:

$$\sum A_n \left[(\omega_n^2 - \omega^2) N_{mn} \cos(\omega t - \theta_n) - \omega D_{mn} \sin(\omega t - \theta_n) \right] = F_m \quad (2-9)$$

$$N_{mn} = \int_L [(I_o + I_a) \theta_n \theta_m + (m_s + m_a) w_n w_m] dz$$

$$D_{mn} = \int_L [C_o \theta_n \theta_m + C w_n w_m] dz$$

$$F_m = F_{Cm} \cos \omega t + F_{Sm} \sin \omega t$$

$$F_{Cm} = \int_L (b_C \theta_m + f_C w_m) dz$$

$$F_{Sm} = \int_L (b_S \theta_m + f_S w_m) dz$$

where m_a and I_a are added mass and added mass moment of inertia. C_o and C are damping coefficients, including all damping components.

Unless the damping is everywhere proportional to mass, the coefficients A_n for various modes are coupled by the terms associated with the damping. If the damping coefficients are known, this causes no problems. Equation 2-9 can be solved explicitly for as many A_n as desired. All coupled terms can be taken into consideration.

For the present project, the damping coefficients are unknown and must be determined from the measurements. The coupling of the damping terms becomes a problem; however, the solution is to excite the ship in such a manner that the response can be controlled to be primarily in one particular mode (at a time). Then contributions from other modes become negligible and the off-diagonal terms in the matrix D_{mn} can realistically be neglected. This concept is the basis for the entire experimental program which is developed in Section 3. The success or failure of the

project rests on the ability to devise an excitation method which closely achieves this "single-mode" response, for each of the modes of interest. The theoretical basis for selecting the excitation which will achieve this single-mode response is developed in Section 3. Since θ and w in equation 2-9 are eigenvectors, orthogonality implies that the matrix N , with components N_{mn} is diagonal. For these reasons, all coupled terms can be neglected in equation 2-9, which reduces to:

$$\begin{aligned} A_n(\omega^2 - \omega_n^2)N_{nn}\cos(\omega - \theta_n) - \omega D_{nn}\sin(\omega - \theta_n) \\ = F_{cn}\cos\omega t + F_{sn}\sin\omega t \end{aligned} \quad (2-10)$$

Collecting the terms associated with $\cos \omega t$ and $\sin \omega t$ provides two equations with two unknowns, A_n and θ_n . Solving for A_n and θ_n yields:

$$\theta_n = \tan^{-1} \frac{\mu_n \omega f_{nc} + (\omega_n^2 - \omega^2) f_{ns}}{(\omega_n^2 - \omega^2) + \mu_n \omega f_{ns}} \quad (2-11)$$

$$A_n = \frac{\sqrt{f_{nc}^2 + f_{ns}^2}}{\sqrt{(\omega_n^2 - \omega^2)^2 + \mu_n^2 \omega^2}} \quad (2-12)$$

where

$$f_{nc} = \frac{F_{cn}}{N_{nn}}, \quad f_{ns} = \frac{F_{sn}}{N_{nn}}, \quad \mu_n = \frac{D_{nn}}{N_{nn}}$$

Substituting equation 2-12 into equation 2-7:

$$s(x, t) = \sum \frac{\sqrt{f_{nc}^2 + f_{ns}^2} \cos(\omega t - \theta_n)}{\sqrt{(\omega_n^2 - \omega^2)^2 + \mu_n^2 \omega^2}} S_n(x) \quad (2-13)$$

2.1.1.3 Transient Or Non-Harmonic Vibration - For non-harmonic vibrations which must be analyzed in the time domain, the above procedure can also be used, except that a more general, non-harmonic mode shape must be used. Such a mode shape can be defined by:

$$s(x, t) = \sum A_n(t) S_n(x) \quad (2-14)$$

Substituting this expression into equation 2-1 provides:

$$\sum [M\omega_n^2 A_n(t) + \omega D \dot{A}_n(t) + \ddot{M} A_n(t)] S_n(x) = F(x, t)$$

This expression can be used together with the result:

$$F_n(t) = \frac{\int_0^L F(z, t) w_n(z) dz}{N_{nn}}$$

To provide a solution for the modal response of the ship:

$$\ddot{A}_n(t) + \omega_n \dot{A}_n(t) + \omega_n^2 A_n(t) = F_n(t) \quad (2-15)$$

Equation 2-15 can be solved explicitly. By substituting $A_n(t)$ into equation 2-14, the ship responses can be obtained.

In general, $A_n(t)$ can be written as:

$$\begin{aligned} A_n(t) = & e^{-\zeta_n \omega_n t} \left[\cos \alpha_n t + \frac{\zeta_n \omega_n}{\alpha_n} \sin \alpha_n t \right] A_n(0) \\ & + e^{-\zeta_n \omega_n t} \frac{\sin \alpha_n t}{\alpha_n} \dot{A}_n(0) \\ & + \int_0^t F_n(\gamma) e^{-\zeta_n \omega_n (t-\gamma)} \frac{\sin \alpha_n (t-\gamma)}{\alpha_n} d\gamma \end{aligned} \quad (2-16)$$

$$\zeta_n = \frac{\mu_n}{2\omega_n}, \quad \alpha_n = \omega_n \sqrt{1 - \zeta_n^2}$$

If equation 2-16 is substituted into equation 2-14, we have the solution for transient vibration of the ship.

2.1.2 The Theoretical Basis Of Transient Damping Testing

From equation 2-16, if the ship is excited to a certain motion with initial displacement and/or velocity, the motions will gradually decrease to zero without further excitation. If we can measure the displacement at a suitable point of the ship and can filter the contribution of the different modes into separate recorders, then we can calculate the parameter, ζ_n , which is a function of the vibration damping.

Let t_0, t_m be the time when the displacement reaches the peaks, $w_n(x, t_0), w_n(x, t_m)$, and t_m is m periods after t_0 . Then from equation 2-16:

$$\frac{w_n(x, t_0)}{w_n(x, t_m)} = e^{\frac{\mu_n}{2} \frac{2m\pi}{\alpha_n}} \quad (2-17)$$

in which e is the base of the natural logarithm, therefore

$$\frac{\mu_n}{\alpha_n} = \frac{1}{m\pi} \ln \left[\frac{w_n(x, t_0)}{w_n(x, t_m)} \right] \quad (2-18)$$

This is usually called the "logarithmic decrement." For convenience of discussion, the parameter, μ_n , is called total damping coefficient.

The coordinate variable, x , in the above equation indicates that the displacement can be measured at any point along the length of the ship at which there is sufficient (measurable) response.

Once the value of μ_n is determined, we have from equation 2-12:

$$D_{nn} = \mu_n N_{nn}$$

or

$$\int_0^L (C_o \theta_n^2 + C w_n^2) dx = \mu_n N_{nn} \quad (2-19)$$

where θ_n and w_n are the mode shapes of the nth mode.

2.1.3 The Theoretical Basis Of The Magnification Damping Tests

From equation 2-13, if the excitation force is given and the contribution of different modes can be separated, the damping can be calculated as follows:

Letting $W_n(x)$ be the measured peak of a steady-state vibration associated with the nth mode, we have

$$W_n(x) = \frac{\sqrt{f_{nc}^2 + f_{ns}^2} \cdot w_n(x)}{\sqrt{(\omega_n^2 - \omega^2)^2 + \mu_n^2 \omega^2}} \quad (2-20)$$

$$\mu_n = \left[\frac{f_{nc}^2 + f_{ns}^2}{\omega^2} \left(\frac{w_n(x)}{W_n(x)} \right)^2 - \frac{(\omega_n^2 - \omega^2)^2}{\omega^2} \right]^{1/2} \quad (2-21)$$

This is usually considered as the magnification method. In order to obtain the maximum responses due to limited excitation capacity, the excitation frequency is chosen so that resonant conditions can be reached, $\omega = \omega_n$.

2.1.4 The Distribution Of The Damping Coefficients

Theoretically, the distribution of the damping coefficients can be calculated as follows:

- a. The total damping coefficient, μ_n , associated with different modes are calculated according to the measurement as shown in equation 2-17 or 2-21.
- b. Let the distribution of C_o and C be represented by m discrete points such as $C_o(x_1), \dots, C_o(x_m), C(x_1), \dots, C(x_m)$. Then equation 2-19 can be evaluated numerically in terms of the unknowns, $C_o(x_i), C(x_i), i = 1, \dots, m$, as follows:

$$\int_0^L \left[\sum_i C_o(x_i) \theta_n^2 + \sum_i C(x_i) w_n^2 \right] dx = \mu_n N_{nn} \quad (2-22)$$

The above expression is used to represent the integration scheme for two curves with m coordinates. Any numerical method such as Simpson's Rule can be used. The results will be a set of simultaneous equations as follows:

$$\sum_j^m A_{ij} C_o(x_j) + \sum_j^m b_{ij} C(x_j) = \mu_n N_{ii} \quad (2-23)$$

where $C_o(x_j)$ and $C(x_j)$ are the total damping to be determined.

$$A_{ij} = \int_{\alpha}^{\beta} \theta_i^2(x) dx$$

$$b_{ij} = \int_{\alpha}^{\beta} w_i^2(x) dx \quad (2-24)$$

where $\alpha = \frac{x_i + x_{i-1}}{2}$ $\beta = \frac{x_{i+1} + x_i}{2}$

2.2 Components Of Ship Vibration Damping

The ship vibration damping can be separated into the following three components:

- ° Structural damping
- ° Hydrodynamic damping
- ° Cargo damping

There are many mechanisms by which the energy can be dissipated. But if we can lump all these mechanisms together into these three components and measure them experimentally, a big improvement to the state-of-the-art of ship vibration calculations will result.

2.2.1 Structural Damping

When the structure is deformed by external forces, part of the energy is dissipated as heat into the environment. The friction between structural members not rigidly connected can also dissipate energy. In general, the structural damping has two components: viscous structural damping and Kelvin-Voight structural damping.

2.2.1.1 Viscous Type Of Structural Damping, C_v

The damping force due to this type of damping is equal to the product of the velocity and the damping coefficient C_v .

$$\text{Damping force} = C_v \dot{w} \quad (2-25)$$

This type of structural damping, even though assumed by almost all ship vibration experts, has a very serious basic problem since it indicates that energy can be dissipated by the structure without structural deformation. This is the case when the ship is in pure heaving and pitching motions.

Obviously this is not correct. Therefore, some refinements are needed to modify this viscous damping assumption. One ra-

tional modification is to associate the damping force with the higher derivatives of the displacement such as:

$$\text{Damping force} = C_b \dot{\psi}', C_k \dot{w}'''' \quad (2-26)$$

In this case, these damping loads become zero if only rigid body motions are involved. Since

$$\dot{w}'''' = 0, \dot{\psi}' = 0, \text{ for } w = Y - \psi x$$

where

Y is the heaving motion (displacement)

ψ is the pitching motion (angle)

x is the coordinate along the length of the ship with origin at the center of gravity of the ship

(See Figure 2-1 for definition of y, ψ , and x.)

Actually the damping moment of $EIC_k \dot{w}''''$ is usually called the Kelvin-Voight type of damping. It will be discussed in the following section.

2.2.1.2 Kelvin-Voight Type Of Structural Damping, C_k

The damping force is given by the expression:

$$\text{Damping force} = EIC_k \dot{w}'''' \quad (2-27)$$

The relationship between the total damping μ_n and these two components of structural damping can be expressed as follows:

$$\mu_n \propto C_k \omega^2 + C_v \quad (2-28)$$

Other types of structural damping have been discussed by Betts, Bishop and Price (Reference 2-13). From the above discussion and from those in Reference 2-13, it is obvious that our ignorance about structural damping is not limited to its magnitude and distribution.

It has been shown experimentally that hydrodynamic damping is negligible at higher frequencies. The most important damping is, therefore, structural. Since the assumption of viscous structural damping is questionable, other types of damping should also be investigated in the correlation between the experimental and analytical solution. The Kelvin-Voight type of damping can easily be taken into consideration by equation 2-1

Ref. 2-13: Betts, C. V., R. E. D. Bishop and W. G. Price, "A Survey of Internal Hull Damping," RINA, 1976.

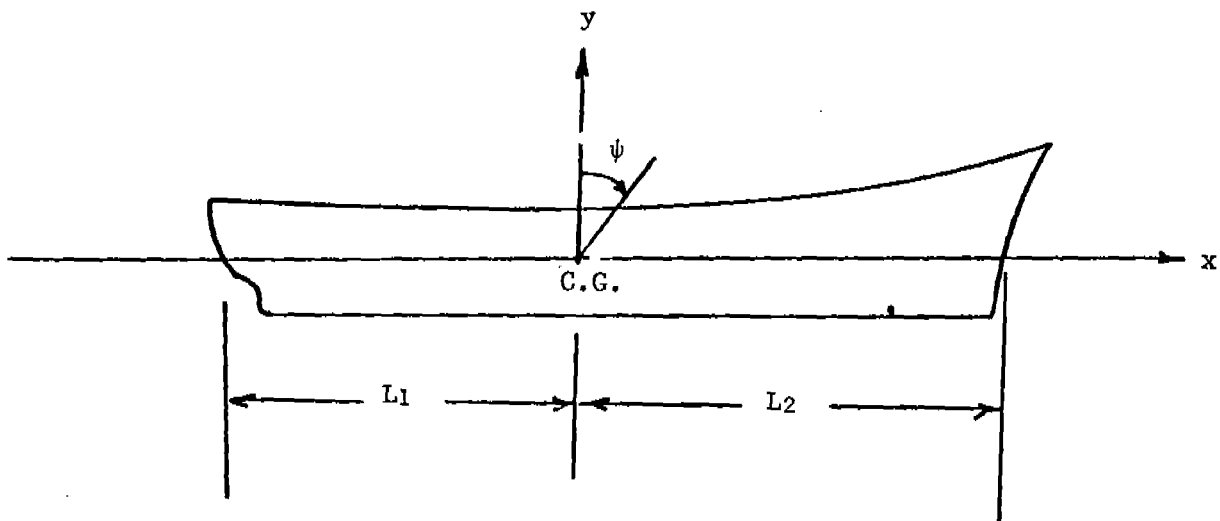

Figure 2-1 COORDINATE SYSTEM

as shown in equation 2-28. It is, however, quite possible that other types of structural damping are also important. For that reason, it is desirable to establish the effects of all other types of structural damping on the solution given here from equation 2-1 to equation 2-24 or to other solutions.

2.2.2 Hydrodynamic Damping

All hydrodynamic damping is considered to be of the viscous type. Energy is dissipated by the surrounding water by generating surface waves and/or pressure waves. The basic assumption of the strip theory for seakeeping is that the damping coefficient and added mass coefficient of the two-dimensional theory is applicable to three-dimensional hulls. Reference 2-12 shows that these coefficients can be calculated quite accurately.

The ship is not, however, two-dimensional, especially near the stern and the bow. At present, accurate methods are not available for the three-dimensional effects.

2.2.3 Effects Of Forward Speed On Damping

In Reference 2-12, it is shown that at higher speeds the hydrodynamic damping becomes negligible, and that the damping effects due to the forward speed become commensurately important. The effects of forward speed remain an unsettled issue, and it is, therefore, very important to isolate any forward speed effects in the experimental program for determining damping coefficients.

2.2.4 Cargo Damping

There is very little reliable data regarding cargo damping. In the damping experiments, the damping effects of common types of cargo should be evaluated.

2.3 Effects Of Damping On The Vibration Response Of Ships

The importance of effects of damping on the vibration response of ships can be assessed by means of equation 2-13. In considering the case in which the excitation is coincided with one mode and the excitation frequency is equal to the natural frequency of that mode, we have from equation 2-13:

$$S(x,t) = \frac{\sqrt{f_{nc}^2 + f_{ns}^2}}{\mu_n \omega} \cos(\omega t - \theta_n) S_n(x,t) \quad (2-29)$$

This shows that the response is inversely proportional to damp-

Ref. 2-12: Vingt, J. H., "The Hydrodynamic Coefficients for Swaying, Heaving and Rolling Cylinders in a Free Surface," TNO Report No. 112S, May 1968.

ing. Kline has pointed out that the predicted response can differ from the observed response by as much as an order of magnitude, depending on the value of the damping coefficient used.

3.0 PLAN FOR EXPERIMENTAL DETERMINATION OF THE DAMPING COMPONENTS

3.1 The Importance Of Theoretical Guidance

The preceding discussion has shown that ship damping coefficients cannot be measured directly from experiments. What can be measured are only the responses of the ship and/or the model. From these measurements, the damping coefficients can then be determined by ship vibration theory. The damping coefficients so determined are strictly speaking the coefficients associated with that particular theory and thus inherit all the limitations and approximations of the theory. Once the experimental measurements have been made, however, damping coefficients could be calculated for various theories. Then simpler theories, which are useful for many purposes, could benefit from the data generated.

In Section 2.2.3, the importance of the effects of forward speed was discussed. Reference 2-11 states that the forward speed affects not only the damping forces but also the stiffness, and hence the natural frequencies of the ship. If theories neglecting these forward speed effects are used to calculate damping coefficients from the experimental data, erroneous damping coefficients may result. However, as has been previously discussed, the effects of the forward speed are still unsettled in the existing theory. It is, therefore, desirable to have an analytical investigation of these effects before the implementation of the experimental program. The purpose of the investigation would be to evaluate the theoretical importance of forward speed effects, and to evaluate the conditions (speed, stiffness and other parameters) under which forward speed effects are significant, and conditions under which forward speed effects can realistically be neglected. If the analytical investigations show forward speed to be an important factor bearing on ship response to excitation, and any damping coefficients calculated from the measured responses, then the damping experiments will have to be conducted both in still water, and at forward speed. In this case, the theory used to calculate damping coefficients from the measurements should be adjusted to include terms associated with forward speed effects.

Also of importance is the guidance of the proper theory in the preparation of the experiment, the definition of the measurements and the determination of the requirement of the excitation devices. Without such proper theoretical guidance, the data from the experiment may be inaccurate, or they may be quite accurate but not useful for making reliable ship vibration predictions.

In the past, many ship vibration experts have had the tendency to lump all uncertainties into the uncertainty of damping. Surely, anybody can hindcast ship responses after they are measured, by any ship vibration theory, by freely adjusting the damp-

ing coefficient. But this practice does not necessarily provide the damping data needed to make reliable predictions for other (future) cases.

The above discussion shows the importance of verifying some of the other uncertainties in the ship vibration theory. This will be discussed in the next section.

3.2 Objectives Of The Experiments

The above discussion has stressed that the accuracy of the damping coefficients depends not only on the accuracy of the measurement of the ship vibration response but also on the accuracy of the vibration theory by which the damping coefficients are deduced. For this reason, the damping experiments should not be limited to the determination of the damping coefficient. Practically, the experiments required for the determination of damping coefficients can also generate many other useful data in addition to the damping coefficients. For this reason, one of the objectives of the damping tests should be the correlation of the existing theories.

In general, the goal of the experimental program is to conduct model and full-scale tests, and to make appropriate measurements such that the following objectives can be achieved:

1. Isolation and determination of the magnitude and distribution of the components of the damping coefficients by making measurements of the responses under specified excitation. The following components should be isolated:
 - Hydrodynamic damping
 - Structural damping
 - Cargo damping
2. Isolate and determine the effects of the excitation frequency and the natural frequencies on the above damping coefficients.
3. Isolate and determine the hydroelastic effects due to the forward speed on the following parameters:
 - The natural frequencies
 - The damping force
 - The inertia force
4. Correlate the measured responses with the various existing ship vibration theories:
 - Calculate the responses of the same models or ships by various theories with the same damping and added mass coefficients
 - Compare the results with the measured responses.

3.3 Recommended Test Program

In order to achieve the above objectives, a program of both full-scale and model experiments are recommended. Before discussing the details of the experimental program, the basic purpose and reason for recommending each experiment is presented.

3.3.1 Rigid Model Experiments

The main purpose of the rigid model experiments is to evaluate hydrodynamic damping. In Section 2.1, the inadequacies of existing analytical techniques for assessing added mass and hydrodynamic damping near the bow and stern of ships is discussed. The models would be used to correct the two-dimensional conformal mapping methods to account for the three-dimensional effects of a particular shape. As such, the models would have to simulate only the geometric and inertial properties of the real ship. The rigid models would thus serve to isolate the hydrodynamic damping coefficients. If the analytical investigation of the effect of forward speed discussed in Section 3.1 shows forward speed to have a significant effect on hydrodynamic damping, the rigid model test would be conducted both in still water and with forward speed in water to correlate the motions at sea and the hydrodynamic damping of the ship hull.

3.3.2 Flexible Model Experiments

To determine the effects of hull flexibility on hydrodynamic damping, flexible model experiments are also recommended. The models would be excited both in air, and in water to isolate the effects of flexibility on hydrodynamic damping. Structural damping would be constant for both cases (in air, and in water), so the effect of hydrodynamic damping could be isolated. If forward speed effects are shown to be significant, the flexible model tests would also be conducted with forward speed in water.

3.3.3 Full-Scale Experiments

Full-scale damping tests are recommended for ships with and without various cargos. The purpose of these tests is to evaluate structural damping and cargo damping. Since the hydrodynamic damping coefficients are known from the model experiments (and calculated from empirically adjusted prediction methods), the structural damping coefficients and cargo damping coefficients can be isolated from the total damping by performing tests with and without cargo. Tests with and without cargo should be conducted at the same draft so the ship should be ballasted to simulate full-load draft and operating draft.

If forward speed is shown to be a significant factor bearing on hull response and damping data calculated from response measurements, then the full-scale experiments should also be conducted with forward speed.

3.3.4 Summary Of Recommended Experiments

In order to achieve the objectives outlined in Section 3.2, the following experimental program is recommended. Experiments at forward speed are conditional, depending upon the outcome of the analytical investigation recommended in Section 3.1. If the results of the analytical investigation are inconclusive regarding the effects of forward speed, then some or all of the tests with forward speed could be conducted to settle the issues.

1. Rigid Hull Model Experiments

- Stationary in water
- With forward speed in water (conditional)

2. Flexible Model Experiments

- Stationary in air
- Stationary in water
- With forward speed in water (conditional)

3. Full-Scale Experiments

- Stationary in water
- With forward speed in water (conditional)
- With various cargos in water
- Without cargo in water
- With ballast in water at operating draft
- With ballast in water at full-load draft

3.4 Methods For The Determination Of The Damping Coefficients

Analytical methods for extracting damping coefficients from the measurements of both full-scale and model tests are discussed in this section. It has been previously shown that the magnification factor method in resonance testing is considered to be the most accurate. However, transient (logarithmic decrement) measurements will also be made and compared to magnification factor damping coefficients. The magnification factor can be determined from either measured displacement or the measured bending moment. If a continuous model is used, the bending moment can be determined from the measured strain.

3.4.1 Displacement Method

From equations 2-18 and 2-21, the damping coefficients can be determined if the displacements are measured. If only the logarithmic decrement is required, the magnitude of the excitation is not important so long as it can generate sufficient response for accurate measurements. If the magnification method is used, both the displacements and the excitation must be measured. One of the difficulties of this method concerns the ability to accurately measure the displacements. In addition, the measured displacements also include the displacements of local structural components.

3.4.2 Bending Moment Method

If $\bar{w}_n(x)$ and $w_n(x)$ are replaced in equation 2-21 by $\bar{M}_n(x)$, and $M_n(x)$, where $M_n(x)$ is the bending moment mode and $\bar{M}_n(x)$ is the measured bending moment, the damping coefficients can then be determined as previously described. For segmented models, the $\bar{M}_n(x)$ can be measured by dynamometers between two segments. For continuous model, $\bar{M}_n(x)$ can be calculated from the measured strain.

The measured strain may also include the components due to local deformation. Part of this local effect can, however, be excluded by putting strain gauges on both sides of the plates.

In addition to the method given in Section 2.1.4, the damping coefficients can also be determined by direct integration of the excitation, the inertia, and the damping forces as follows:

For a given harmonic excitation, from the third equation of equation 2-1, the bending moment at any cross section can be calculated as follows:

$$M(x,t) = \int_{-L_1}^x [V(\lambda,t) + I_0\ddot{\theta} + C_0\dot{\theta}]d\lambda \quad (3-1)$$

From the last equation of equation 2-1,

$$V(x,t) = \int_{-L_1}^x [m_s\ddot{w} + C\dot{w} - F(w,\xi,\lambda,t) - Q(\lambda,t)]d\lambda \quad (3-2)$$

By measuring the bending moment, the acceleration, velocity at enough locations along the length of the ship, the distribution and magnitude of the damping coefficients can be calculated as follows:

1. Measure the acceleration along the hull at enough points so that a continuous curve of acceleration can be plotted. From this curve, the deflection and velocity curve can be constructed.
2. Measure the bending and shear stress at enough points along the girth of a section of the ship so that the bending moment and shear force at those sections can be calculated.
3. Since all the terms in equation 3-1 and 3-2 are known from the measurements, the unknown values of $C_0(x)$ and $C(x)$ can be calculated. In general, C_0 and C can be represented by certain discrete values, C_{0i} , C_i , $i = 1, m$, along the length. From equations 3-1 and 3-2 and 2-13, enough equations can be generated for the calculation of unknown C_{0i} , C_i .
4. In case of the rigid model tests, the displacement curve is a straight line; the acceleration

of two points at different locations along the length would suffice to characterize all the motions.

3.4.3 Required Measurements

- a. Minimum measurements. From equations 2-17, 2-18 and 2-23, it is theoretically possible to determine the magnitude and distribution of the damping coefficient by measuring the transient displacement (or bending moment) of the ship's hull as follows:
 - Excite the hull with enough force so that the displacement or bending moment ($w(x,t)$ or $M(x,t)$) can be measured.
 - Filter the measured displacement (or moment) into curves associated with different modes.
 - Calculate the logarithmic decrement and calculate the damping coefficients from equation 2-23.

It has been pointed out that the displacement measurements are quite difficult and it may be more accurate to measure the bending moment.

- b. Desirable measurements. Even though theoretically the damping coefficients can be determined with the minimum measurements, there remain several uncertainties and difficulties in implementing the method. It is difficult to separate the local and girder responses at a given location. Also, as discussed in Section 2.1.1.2, the damping coupling between different modes is significant, and couples the responses. This makes it very difficult to correlate between theory and measurements, and it is difficult to check the reliability of the data.

It has been shown that there are several ways of determining the damping coefficients. It is desirable to determine the correlation between these different methods. Even if we are using the method suggested here, the damping coefficients determined from the measured bending moment may be different from those calculated from the measured displacement. For these reasons, it is highly desirable to obtain measurements of bending moments, accelerations, and displacements. These data should be obtained at about at least five positions along the ship or the model. The bending moment can be measured by dynamometers at the joints for segment models. For continuous models and for the full-scale ships, it is necessary to measure the strain of the cross section so that the bending moment can be calculated.

It is also desirable that both the steady-state motions and the transient motions be measured so that the damping coefficients can be determined by both the logarithmic decrement method and the magnification method.

Note that even though the main objective of the experiments is to determine the damping coefficients according to the ship vibration theory, it is inevitable that the validation of the theory is also involved. By different measurements and different methods for the prediction of the ship vibration responses, we can remove many of the uncertainties from the existing ship vibration theory.

3.4.4 Method Of Excitation

As discussed in Section 2.1.1.2, the ship is to be excited in such a manner that the response can be controlled to be in one particular mode (at a time). The location and magnitude of the excitation can be determined by equation 2-9. In equation 2-9, F_{cm} is the in-phase component of the excitation (forcing function) and F_{sm} is the out-of-phase component. Also, b_s and b_c in equation 2-9 are the excitation moments and f_c and f_s are the excitation forces. There is no value in having excitation moments in the planned experiments, and the force excitation can be controlled such that there will be no out-of-phase component, in which case b_c , b_s and f_s are all zero in equation 2-9, and the expression for the excitation (equation 2-9) reduces to:

$$F_m = F_{cm} \cos \omega t \quad (3-3)$$

in which $F_{cm} = \int_0^L f_c w_m dx$

Theoretically we can adjust the excitation forces such that

$$f_c = a m_0 \omega_n \quad (3-4)$$

where a is a constant.

Substituting equation 3-4 into equation 3-3 yields

$$F_{cm} = a \int_0^L m_0 \omega_m \omega_n dz \quad (3-5)$$

Due to the orthogonality of the eigenvectors, w_m , this reduces to

$$F_{cm} = 0 \text{ when } m \neq n$$

$$F_{cm} = \text{maximum when } m = n$$

In other words, the excitation depicted by equation 3-4 will theoretically maximize the in-frequency modal response and minimize the off-frequency modal response.

In general, it is impossible to make $F_{cm} = 0$ for all $m \neq n$. But practically, F_{cm} can be constructed as follows:

Let $F_i \delta(x-x_i) \cos \omega_n t$ be the excitation, from equation 3-5 we have:

$$\sum_i^N F_i v_m(x_i) = F_{cm} \quad (3-6)$$

where N is the number of excitors.

From this equation the magnitude of F_i can be solved so that $F_{cm} \neq 0$, $F_{cn} = 0$ for $N-1$ modes. It can be proved that F_{cn} for the other modes are negligible.

Figure 3-12 shows that three excitation devices would be needed to simulate the first mode (i.e. the 2-node mode) or the third mode (the 4-node mode). Four excitation devices are needed for the fifth mode (6-node mode). Modes above the fifth could be approximated with five excitation devices. Figure 3-1c shows the approximate location of five exciters shown as F_1, F_2, F_3, F_4, F_5 on a model of a ship which will be discussed later. Excitation devices capable of producing the desired sinusoidal forcing function are discussed in detail in Section 3.7.3 and Appendix A.

3.5 Model Tests

In Section 3.3, the rationale and need for both rigid and flexible model tests were discussed and a recommended program of model tests was presented. The recommended model experiments are summarized below

1. Rigid hull model experiments

- Stationary in water
- With forward speed in water (conditional upon the outcome of the analytical investigation into effect of forward speed)

2. Flexible model experiments

- Stationary in air
- Stationary in water
- With forward speed in water (conditional upon the outcome of the analytical investigation into the effect of forward speed)

Note: If the analytical investigation into the effect of forward speed is inconclusive, these model tests at forward speed should be performed to settle the issues.

Some of the details and difficulties associated with these tests are presented below along with a brief discussion of model types.

3.5.1 Segmented Models

Segmented models represent the ship in a discrete manner much as mathematical lumped-mass models are used in vibration analysis. This class of model usually consists of several segments (which are very rigid) held together by much less rigid connecting devices. The deformation of the model occurs primarily in the connections between the segments, and dynamometers or other measuring devices are used to measure the forces between any two segments. Because of the limit of budget, some past experiments have been performed using models of only two segments (Reference 3-1). This would be inadequate for the damping tests being recommended. Theoretically, it is necessary to have at least ten segments to make the results meaningful.

3.5.2 Vinyl Models

For the damping experiments, it is recommended that (rigid) vinyl models be used. There are several advantages of the vinyl over the other materials. Its low elastic modulus (about 500,000 psi) makes it more convenient to adjust the flexibility of the models and to obtain measurable response with smaller excitation. Vinyl models are more economical and easier to work with than wood and/or metal. The reliability of the vinyl modeling technique has also been verified by comparison with other models (Reference 3-1).

The technique for the manufacture of vinyl models is discussed in detail in the literature. (See References 3-1, 3-2 and 3-3.) It may be that some of the existing vinyl models may also be suitable for the damping experiments.

3.5.3 The Scale Of The Model

According to the plan presented here for the damping experiments, the "scale effects" are not a problem since the model experiments are not used for the simulation of the responses of the full-scale ship. The size of the model should be large enough to allow space for instrumentation and for measurement.

-
- Ref. 3-1: Dinsbacher, A. L., "Experimental Methods in Ship Structural Evaluation," Ship Structure Symposium 75, 1975.
- Ref. 3-2: Austin, S. L., "Design History of the Rigid Vinyl Model of Hydrofoil Plainview (AGEH-1)," DTNSRDC Report 3883, October 1972.
- Ref. 3-3: Rodd, J. L., "Verification of the Rigid Vinyl Modeling Technique: The SL-7 Structure," SSC-259, 1976.

In general, a 100th scale should be enough for these purposes. The other parameters of the model should be based on the scaling laws given in Table 3-1.

3.5.4 Mechanics And Mechanisms Of The Test Models

The design and construction of the vinyl model should pose no problem. It is important, however, that the major structural components of ship be in scale. Even though the data from the model experiments are not to be used for the simulation of the full-scale ship (except for the coefficients of hydrodynamic damping), they are still useful data for the verification of ship vibration theory. A realistically scaled model is, therefore, important in order to assure the confidence of the designers in application of the theory.

The details of the test model are beyond the scope of this project. These details may be influenced by the test facilities and equipment availability. There are certainly numerous different methods which can serve the same purpose. It is, however, desirable to describe in general terms how these tests can be performed in principle. This will give an indication of what measurements are required and how to carry out the tests.

The M/V "STEWART J. CORT" is a large Great Lakes ore carrier for which much of the engineering data needed to make preliminary vibration analyses is readily available. Accordingly, it will be used to illustrate certain aspects of the model test program and the full-scale test program. This does not imply that "CORT" is the best overall candidate for actual testing, and a search should be made to identify all available ships most representative of U.S. vessels. Figure 3-1 is a sketch of the "CORT" and Figure 3-1c shows the scale model with spring support equivalent to the restoring force of the water. The stiffness of these springs, k_i , can be determined from the relation:

$$k_i = \rho g B_i \quad (3-7)$$

where

ρ is the density of the water

g is the gravity acceleration

B_i is the water plane area represented by the i th spring

Loading brackets should be located well above the water line so that the hydrodynamic characteristics of the model will not be changed by the presence of the brackets. These brackets should be so designed that they do not change the longitudinal stiffness of the hull and that they can be used for attaching the springs or the excitation forces (or displacement devices).

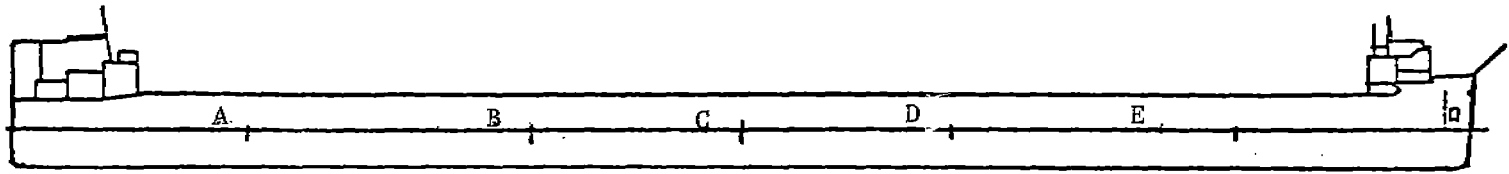

(a)

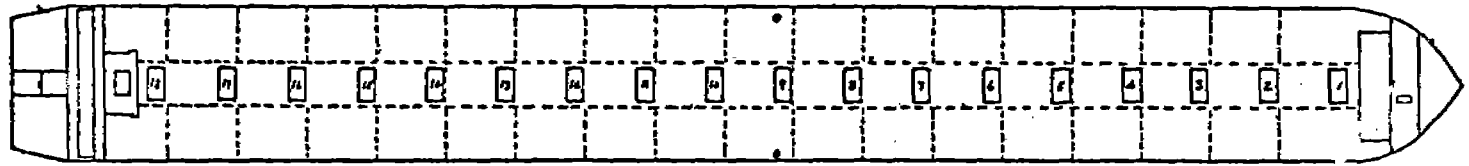

(b)

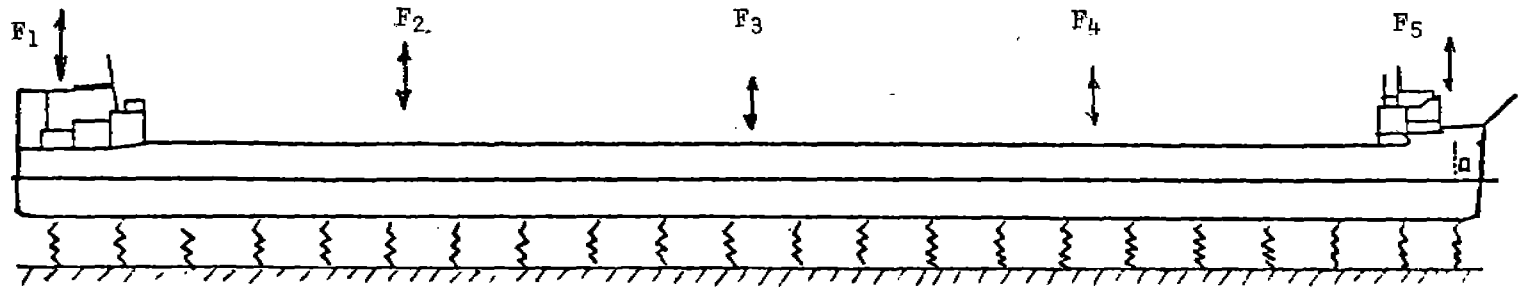

(c)

Figure 3-1 M/V STEWART J. CORT

TABLE 3-1 SCALING RELATIONSHIPS FOR PROTOTYPE AND MODEL

Measured Quantity	Prototype	Model
Length	L_p	$L_m = \lambda L_p$
Strain	ϵ_p	$\epsilon_m = \epsilon_p$
Stress	σ_p	$\sigma_m = e \sigma_p$
Force	F_p	$F_m = e \lambda^2 F_p$
Moment	M_p	$M_m = e \lambda^3 M_p$
Moment of Inertia	I_p	$I_m = \lambda^4 I_p$
Section Modulus	S_p	$S_m = \lambda^3 S_p$
Polar Moment of Inertia	J_p	$J_m = \lambda^4 J_p$
Torque	T_p	$T_m = e \lambda^3 T_p$
Shear	τ_p	$\tau_m = e \tau_p$
Unit Angle of Twist	θ_p	$\theta_m = \frac{e}{g} \theta_p$
Total Angle of Twist	ϕ_p	$\phi_m = \frac{e}{g} \phi_p$
Axial Deformation	δ_p	$\delta_p = \lambda \delta_p$
Mass/Length	ρ_p	$\rho_m = \lambda^2 \rho_p$
Natural Frequency	ω_p	$\omega_m^2 = \frac{\omega_p^2}{\lambda^2}$
<p>Note: In the relationships given above,</p> $\lambda = L_m/L_p$ $e = E_m/E_p$ $g = G_m/G_p$ $G = E/[2(1 + \mu)]$		

(from Reference 3-2)

3.5.5 Flexible Model Experiments

It has been recommended that the flexible model be made of (rigid) vinyl. The construction detail of such a model are referred to in References 3-2 and 3-3. Referring to Figure 3-1 which shows a scale model of the M/V "STEWART J. CORT," it is recommended that strain gauges be installed at five sections, shown as A, B, C, D, and E. The gauges should be installed on both sides of the plate so that the local bending strain can be isolated. The model in Figure 3-1c can be analyzed as a beam with concentrated spring supports and five concentrated forces (or displacements). The mode shapes, natural frequencies and responses of this system can be accurately predicted by the method given in Chapter 2 of Reference 2-9. With these estimates the location and magnitude of the exciters could be determined using the criteria developed in Section 3.4.4. The required measurement, and the method for determining the damping coefficients from the measurement is given in Section 3.4.

3.5.5.1 Experiments In Air With Flexible Model

The experiments in the air can be carried out as shown in Figure 3-1c. The model is supported by the springs with stiffness equivalent to the buoyancy springs. The added mass of the water can be calculated and accounted for by adding weights to the model.

First the natural frequencies of the system (the model and the spring) should be measured up to the tenth mode. Then the model is excited by the calculated excitation forces for the first five modes. The acceleration displacement and bending moment are measured when the motions reach the steady state.

After the measurement for the steady-state motion is completed, the excitation is stopped and the transient responses are measured at the same locations.

3.5.5.2 Experiments In Water With Flexible Model

The above experiments are repeated in the water. The spring supports and the added mass are removed from the model. Again the following measurements are required: the first ten natural frequencies, and the responses (acceleration, displacement and bending moment) for the first five frequencies. For some ships, the first three frequencies are enough; however, responses for the transient motion after the steady state has been reached and the excitation is stopped are also to be measured.

3.5.5.3 Experiments In Water With Forward Speed

These experiments are the same as the above except the model is towed with a forward speed according to the Froude number of the model. Again, the natural frequencies and both steady

state and transient motions are measured. According to Chang's formulation (Reference 2-11), the natural frequencies are also affected by the forward speed. The importance of the forward speed effect can be evaluated. If this effect is shown to be important, the existing ship vibration theory should be modified to include forward speed effects as discussed in Reference 2-11. The overall effect of forward speed determined from this test will establish whether or not the full-scale tests and the rigid-hull model tests must be conducted with forward speed.

3.5.6 Rigid-Hull Model Experiments

The rigid-hull model experiments can be carried out with the same model used for the flexible model experiments. The only adjustment is to substantially increase the stiffness of the hull. This can be done by adding steel strips over the length of the model in such a way as to eliminate internal friction between the steel and the vinyl. These strips can be added on the deck and bottom and sides of the model, and must be adequately secured so that they deformed with the hull girder of the model. The added weight should be balanced by removing some weight from the model. Note that the requirement of the rigid-body assumption is achieved if the (structural) deflection of the hull is much smaller than the (rigid-body) displacements achieved during the experiments. The rigid-hull model experiments should be carried out before the flexible model experiments.

3.6 Correlation Between The Analytical And Experimental Results

Correlation between analytical and experimental results usually means the comparison between the calculated responses and the measured responses. For the damping experiments, however, the correlation involves not only such comparison but also the determination of damping coefficients and, indirectly, the validation of the ship vibration theories. For this reason, the experiments must be guided closely by the theories. Not only the theories of ship vibration but other theories of hydrodynamics, structural mechanics, and the general rules of similitude.

For meaningful correlation between the theories and the experiments, it is most important that the experiments try (as best can be achieved) to simulate the theories. Only by this close cooperation and coordination between the theorists and the experimentalists can fruitful results be obtained from the experiments. Even with such close cooperation and coordination, the conditions of the theories and the conditions of the experiments are not always entirely the same, and these differences must be taken into consideration. Among these effects are: effects of water depth, material properties, local structural response, influence of excitation devices, etc. These are discussed in more detail below.

3.6.1 Effects Of The Depth Of Water

Most hydrodynamic solutions are based on the assumption of infinite boundary (i.e. infinite water depth). The real situation of the experiments is finite boundary. Figures 3-2 and 3-3 from Reference 3-4 indicate the effect of the depth of the water on the natural frequencies of the ship and Figures 3-4 and 3-5 indicate the effects on the damping of the ships.

In the implementation of this plan, the effect of the size of the towing tank must be taken into consideration. This can be done by either doing the experiment in large towing tanks so that the size effects become negligible or by reducing the size of the model so that these effects are negligible. The size of the model must be large enough to allow adequate instrumentation and measurement. The maximum size the model can be without introducing depth effects can be approximately estimated. The experimenter must perform adequate calculations to determine the size of the model proposed for a given test facility.

Obviously, the width of the towing tank also has certain effects on the added mass and damping coefficients, and these effects should also be taken into consideration.

3.6.2 Effects Of The Material Properties

The material properties of the rigid vinyl and the steel strips should also be tested and taken into consideration. In determining the size of the model and the magnitude of the excitations, the responses of the model under the proposed loads must be large enough for accurate measurement but small enough that the stresses are well below the yield point of the material. When two or more different materials are used in the model, the equivalent properties of the composite model must be determined. See Reference 2-9.

3.6.3 Effects Of The Excitation

The weight, motions, damping and responses of the excitors should also be taken into consideration. Calculations performed to determine the damping coefficients, from the measurements, must consider the dynamic system which includes the mass, damping, motions, etc. of excitation devices as well as the ship hull. The stiffness and damping of the springs for the experiment in the air must also be determined. This can be done by a single transient test of the spring alone.

Ref. 3-4: Volcy, G. C., "L'Amortissement dans les Vibration des Navires," Nonveantes Techniques Maritime, 1978.

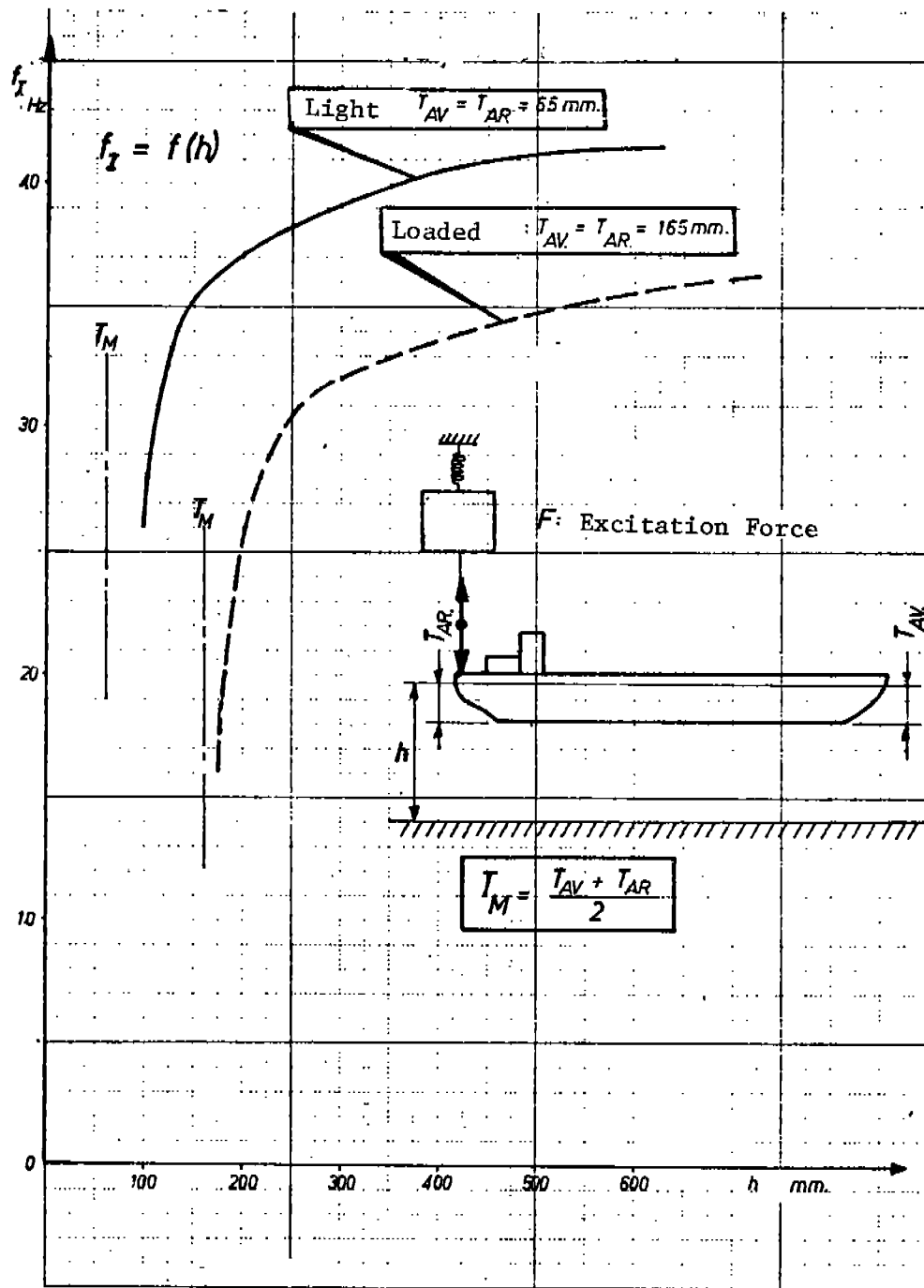
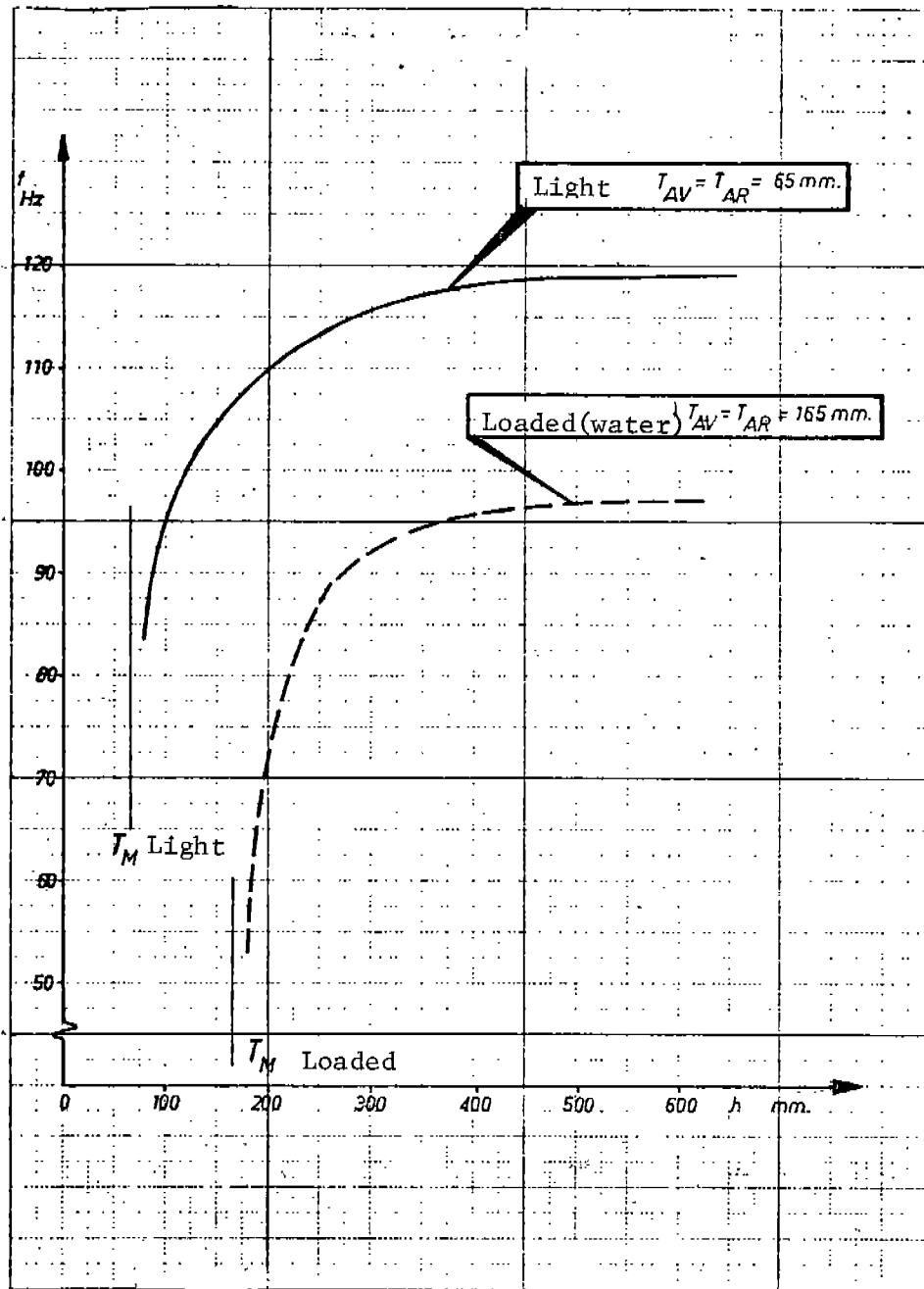
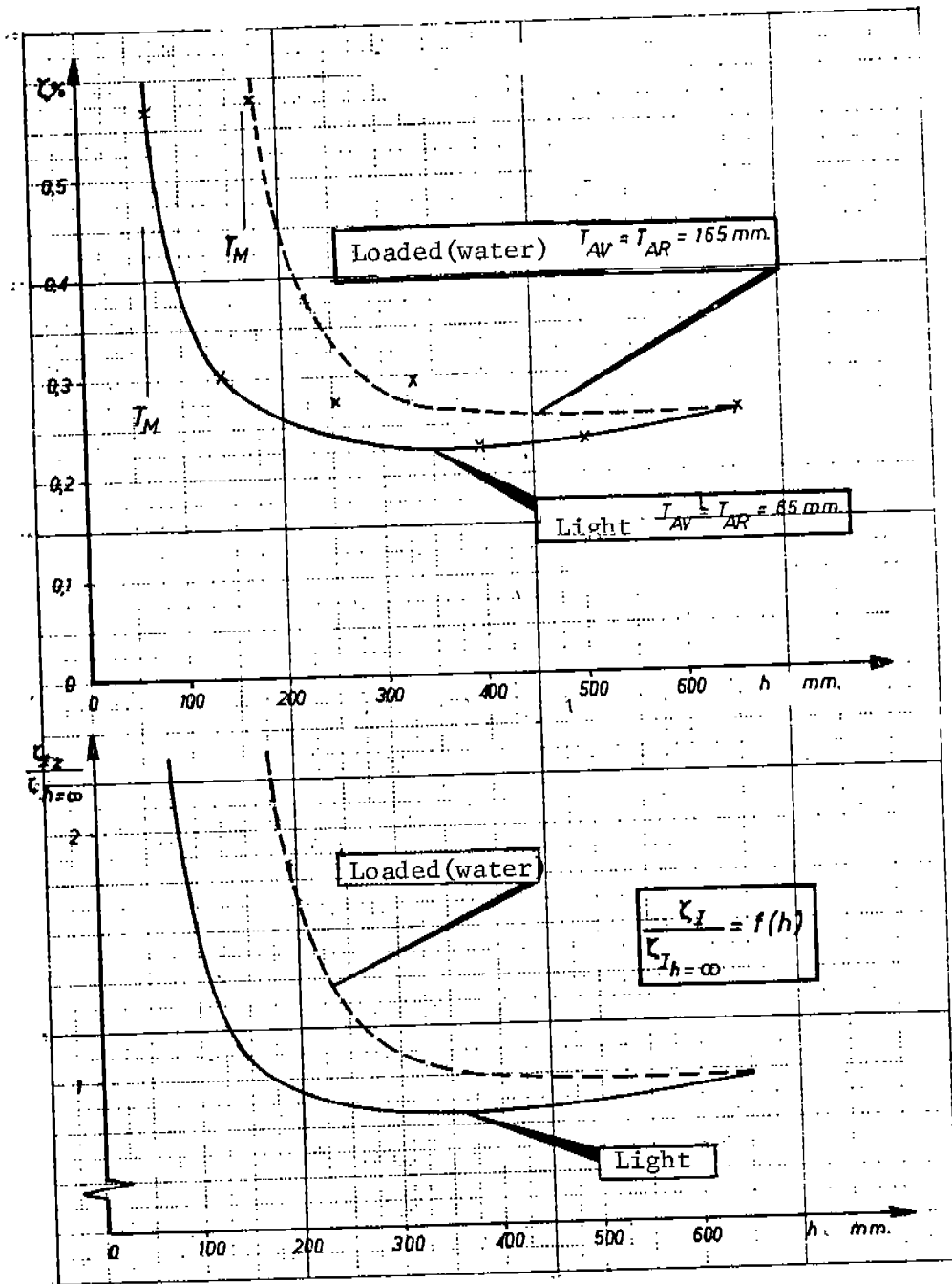

Figure 3-2 EFFECT OF WATER DEPTH ON FIRST MODE FREQUENCY OF SHIP MODEL (from Reference 3-4)



(See Figure 3-2 for definition of symbols)

Figure 3-3 EFFECT OF WATER DEPTH ON THE SECOND MODE FREQUENCY OF SHIP MODEL (from Reference 3-4)



(See Figure 3-2 for definition of symbols)

Figure 3-4 EFFECTS OF WATER DEPTH ON THE DAMPING OF THE FIRST MODE VERTICAL VIBRATION OF SHIP MODEL (from Reference 3-4)

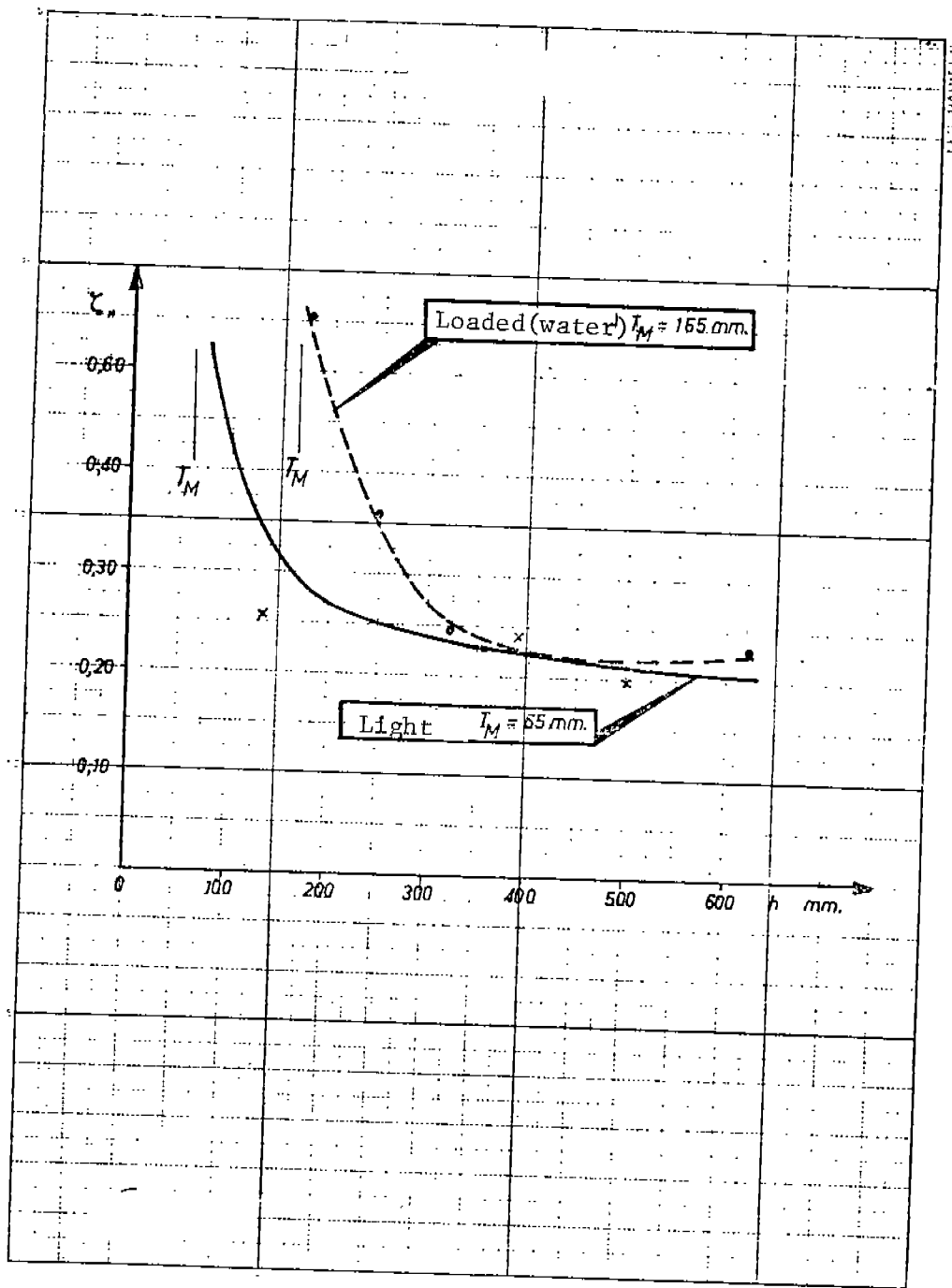

(See Figure 3-2 for definition of symbols)

Figure 3-5 EFFECTS OF WATER DEPTH ON THE DAMPING OF SECOND MODE VERTICAL VIBRATION OF SHIP MODEL (from Reference 3-4)

3.6.4 Effects Of The Responses Of The Local Structural Elements

The beam theory of ship vibration is based on the assumption that plane sections of the ship remain plane after deformation. This assumption is valid for the prediction of the vibratory stress of ships since the local deformation does not affect the stress in other locations. In general, the plane sections may be warped out of plane and the local deformation can also change the shape of the cross sections. In the correlation between the experimental and analytical results, these effects of local deformation must be taken into consideration.

Note that the measured data represent the total responses at the measured location including the beam girder responses and the local responses. Also, the excitations are acting upon local structural elements which then transfer the loads to the beam girder. All these effects must be taken into consideration.

For some ships and models, the local effects can be reduced by applying the excitation to major structural components and measuring the responses from those components. The contribution of the local responses can also be isolated from the measurement since the natural frequencies of the structural elements are usually much higher than the hull girder frequencies.

If it is difficult to install the exciters on the major structural components, special foundations for the exciters are then necessary. The vibration characteristics of such foundations must be estimated to make sure that there is no resonance between the exciters and the hull girder.

It is suggested that initially the natural frequencies of the supporting structures be estimated by means of a simple analytical model. If the natural frequencies are much higher than those of the hull girder, no particular reinforcements are needed. If the local frequencies are close to the hull frequencies, some reinforcements are necessary.

Developing a simple analytical model for a complicated structure requires much skill and experience on the part of the analyst. If there is any uncertainty, a more elaborate analytical model is recommended and a finite-element analysis may be warranted.

The most common and most convenient place for exciters is usually the open deck space. The frequencies of the deck panels with the exciters can be estimated by formulas given in Chapter 7 of Reference 2-9. The accuracy of these formulas has been validated by the more sophisticated methods.

3.6.5 Desirable Correlations

Frequently in the past, discrepancies between the calculated

and measured ship vibration response have been attributed to the inaccuracy or uncertainty of the vibration damping. It is very easy for the experimenter implementing this plan to use this assumption in correlating the experimental and analytical results. With the liberty of using any damping coefficients, any theory can have good correlation with the experiments.

But such correlation is misleading and incorrect. In order to assure that the damping coefficients determined from the experiments are realistic and reliable, the following comparisons are necessary:

- Comparison between the calculated and measured responses to known excitation. Not just the displacement but also the bending moment and acceleration.
- Comparison between the energy input and the energy dissipated.

Note that in the steady-state, the energy input due to the excitation should be equal to the energy dissipated.

- Comparison between the damping coefficients determined from the transient responses and steady state responses.
- Comparison between the responses in different frequencies, in water and in air, with and without forward speed.
- Comparison between the measured frequencies in water and in air, with and without forward speed.

The main criterion for the success of this experiment program is the consistency of all the above calculated and measured data.

3.7 Full-Scale Damping Experiments

The primary purpose of the full-scale tests is to evaluate the structural damping and cargo damping components of the total damping. Since the hydrodynamic damping coefficients are to be determined from the model experiments, cargo and structural damping coefficients can be isolated from the total damping determined from the full-scale experiments.

3.7.1 Recommended Full-Scale Tests

In order to obtain reliable damping data from the full-scale experiments, a systematic experimental program must be conducted. The program would include the following full-scale experiments:

1. Stationary in water
 - ° With cargo
 - ° Without cargo
2. With forward speed in water
 - ° With cargo
 - ° Without cargo

(conditional upon the outcome of either the analytical investigation into the effects of forward speed, or the model experiments conducted with forward speed)

3.7.2 Required Excitation

In accordance with the method being proposed for exciting the ship hull in such a manner that there is negligible coupling between the modes, a minimum of three and preferably five exciters are required. Three exciters should be sufficient for the first few modes, but five would be needed to obtain data for higher modes (see Figure 3-11). Excitation devices must be capable of producing controlled steady-state sinusoidal excitation. Calculations were made to estimate the magnitude of the excitation required to excite a ship to a degree suitable for making the needed measurements. A representative large ship (the Great Lakes ore carrier "STEWART J. CORT") was selected for preliminary estimates as discussed in Section 3.5.4. The principal dimensions of the ship are shown in Table 3-2.

Table 3-2 PRINCIPAL DIMENSIONS OF THE CORT

LBP	988.5 ft.
B	104.6 ft.
D	49.0 ft.
T	27.83 ft.
Δ	74,000 tons
C_B	0.926
I	$1.668 \times 10^4 \text{ft.}^4$
ρ	$6.22 \text{ ton-sec}^2/\text{ft.}^2$
E	$1.9286 \times 10^6 \text{ ton}/\text{ft.}^2$
Buoyancy Spring	$2.85 \text{ ton}/\text{ft.}^2$

Preliminary estimates indicate that the two-node mode of vertical vibration has a natural frequency of about 1/3 Hz., and that three vibration generators, each capable of producing a sinusoidal force of 20,000 lbs. (peak) would be needed to excite the ship sufficiently to be able to accurately make the intended measurements.

For a smaller ship, such as the containerships Cg-S-85a, the excitation can be considerably smaller. The principal dimensions of the C6-S-85a are shown in Table 3-3.

Table 3-3 THE PRINCIPAL DIMENSIONS OF THE C6-S-85a

LBP	625'
B	90'
D	53'
T	33'
Δ	30,000 tons
I	13,750 ft. ⁴
E	1.9286×10^6 tons/ft. ²
ρ (mass and added mass)	5.0 tons-sec. ² /ft. ²
K (buoyancy spring)	2.5 tons/ft. ²

Preliminary estimates indicate that the two-node frequency is about 0.89 Hz. and that three vibration exciters, each with a peak force of 6,000 lbs. at this frequency are required.

Note that the above estimates are based on an estimated damping coefficient $\mu = 0.036\omega_1$, where $\mu_1 = D_{11}/N_{11}$. (See equation 2-12.) If the actual damping is greater than this assumed value, the response of the ship will be smaller. In which case greater excitation may be required.

3.7.3 Excitation Devices

Vibration generators which have been used in the past on vibration studies of large structures were researched. Past vibration tests on ships as well as bridges and buildings were reviewed, and the methods of excitation were studied. Vibration generators may be grouped into three types:

- ° Rotating (eccentric) mass
- ° Electrohydraulic
- ° Electrodynamic

The general capabilities of each type are discussed below.

3.7.3.1 Rotating Mass Vibration Generators

This class of exciter derives its dynamic force output from the centrifugal force of rotating eccentric (or unbalanced) masses. Unidirectional forces or moments are obtained by unbalancing and phasing more than one rotating mass in a common plane. Of the devices studied, some use three rotating masses and some use two. Regardless of the specific mechanisms by which the unbalancing and phasing of the rotating masses is accomplished, all rotating mass generators have the characteristic that the maximum force output is linearly proportional to mass and proportional to the square of the angular speed ω of the rotation. Appendix A gives a summary description of several rotating mass generators which have been used in the past to produce vibrations in ships and bridges. Figure 3-6 is a plot of the maximum single amplitude force output versus frequency for the devices covered in Appendix A. The leveling off of curves

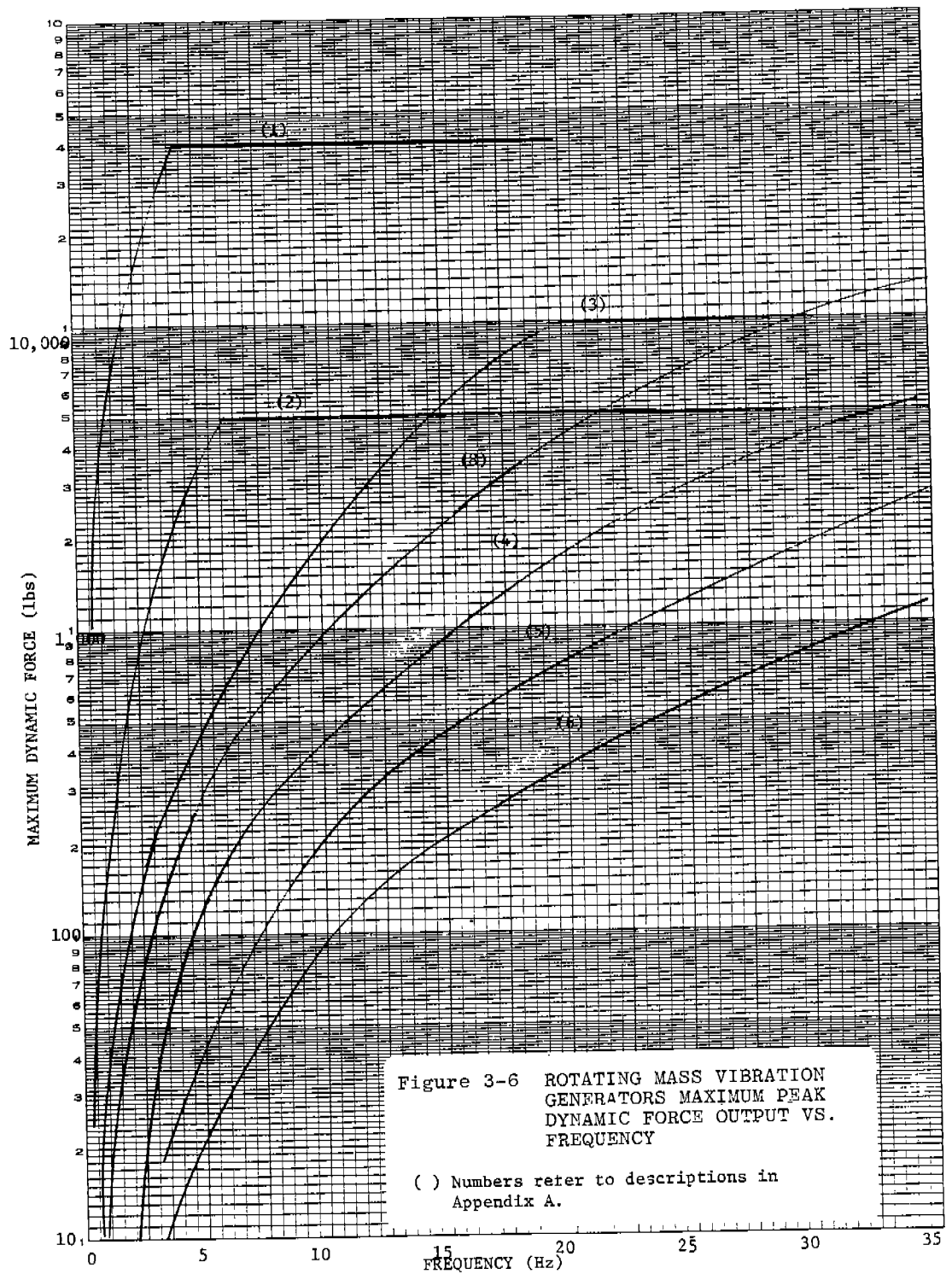

at certain levels of force represent mechanical limitations such as strength, and/or the capabilities of the driving devices. As might be expected at low frequencies, especially as low as 1 Hz. and below, the maximum force output shown in Figure 3-6 are very low for all the devices, and none is capable of producing anything near the 20,000 lbs. of 1/3 Hz. required to excite the 2-node mode of the M/V "STEWART J. CORT." Even the device which is referred to as the "TMB 40,000-pound three mass generator" is not capable of producing 40,000 lbs. until the frequency is about 3.5 Hz.; at 1 Hz. the output is only about 2,500 lbs. (or about 1/3 of the force needed for the container ship Table 3-2) and at 1/3 Hz. the output is about 275 lbs. The "TMB 5,000-pound generator" is capable of generating the full 5,000 lbs. only at frequencies above 6 Hz. and the "L.A.B. type RVCG-10,000-pound vibration exciter system" develops the full 10,000 lbs. only at frequencies above about 20 Hz. The Navy has used the 40,000-pound and 5,000-pound systems successfully on Naval vessels, because the natural frequencies of these smaller, stiffer ships is higher than those to be expected of large tankers and cargo vessels. The conclusion of the investigation is that rotating eccentric mass exciters will not produce the kind of excitation needed for the proposed full-scale damping experiments.

It should be noted, however, that some of the smaller exciters may be adequate for the model tests. For example, if the model scale is 1/100, the model natural frequency according to the similitude laws given in Table 3-1 would be about 100 times larger than the prototype, or about 33.3 Hz. for the M/V "STEWART J. CORT." If the model is made of rigid vinyl ($E = 500,000$ psi) then e in Table 3-1 is $500,000/30,000,000 = 0.0167$ and according to Table 3-1 the required force would be only a few pounds and model LAB "AA" would be adequate for the model tests.

3.7.3.2 Electrohydraulic Vibration Generators

In view of the large forces and low frequencies of interest for the full-scale damping experiments, it appears that the only type of device capable of producing the desired excitation would be an electrohydraulic device. This system consists basically of a mass attached to a hydraulic actuator. Several self-contained systems are available, but their force output at 1 Hz. and below are well under what is required. Baldwin (Reference 3-5) conducted some vibration and fatigue tests on a highway bridge and used the hydraulic exciter shown in Figure 3-7. The system had a moving mass of approximately 10 kips and a hydraulic actuator rated at 25 kips. The force output of this type of device is controlled by various factors including: the stroke of the piston, the frequency of the excitation, and, of course, the

Ref. 3-5: Baldwin, J. W., et al., "Fatigue Test of a Three-Span Composite Highway Bridge," Missouri Cooperative Highway Research Program Final Report 73-1, June 1978.

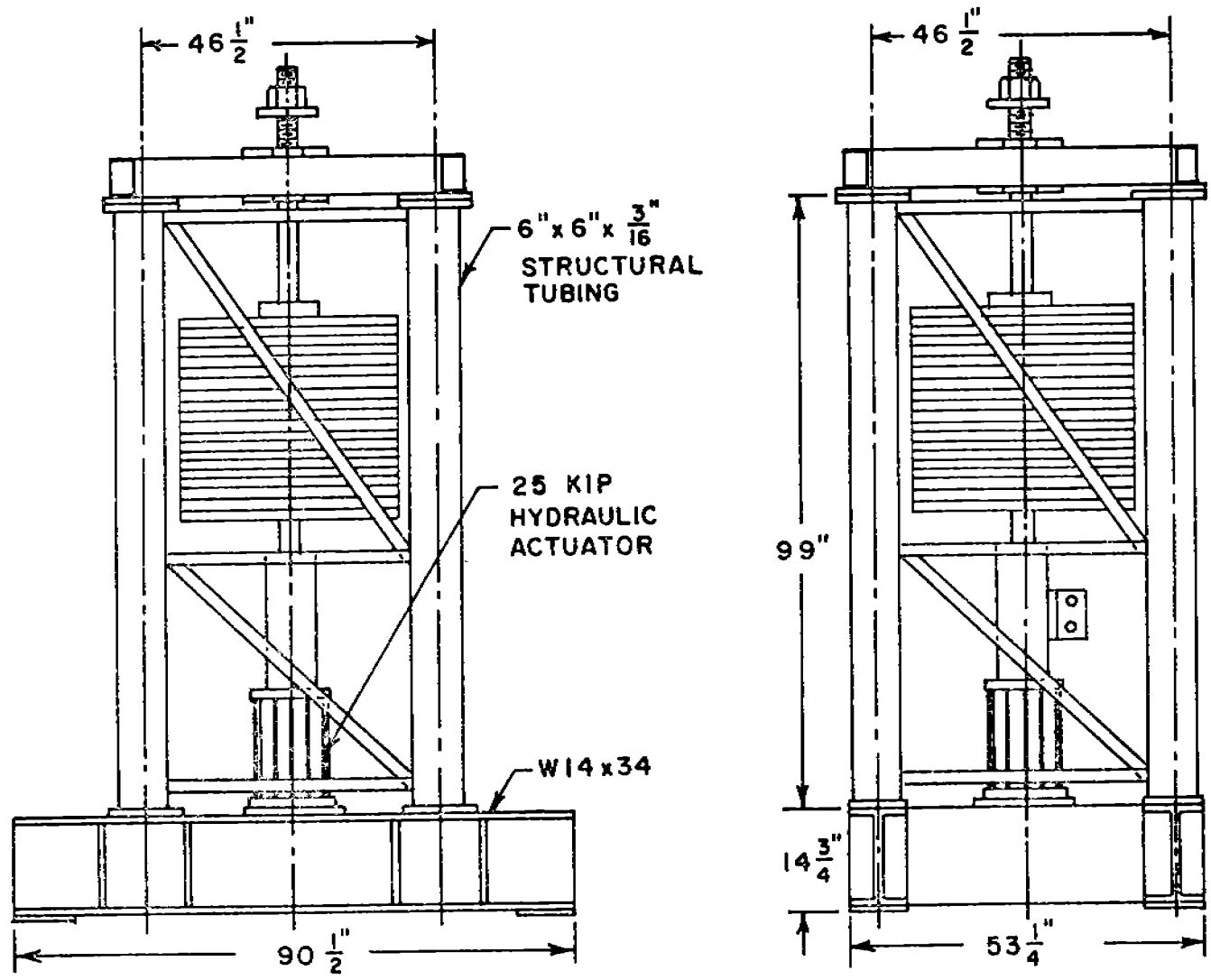

Figure 3-7 HYDRAULIC ACTUATOR AND LOAD DISTRIBUTION FRAME USED BY BALDWIN (Reference 3-5)

rating of the actuator. The force output is the produce of the moving mass M and the acceleration of the moving mass. An approximate relationship for the acceleration of the moving mass in "g's" is

$$g_{\max} = 0.052f^2X_{DA} \quad (3-8)$$

where X_{DA} is the double amplitude stroke of the piston (in) and f is the frequency of the excitation (Hz.).

It is believed that the hydraulic actuator shown in Figure 3-7 had a double amplitude stroke of 10 inches; so at 1 Hz. the peak acceleration of the moving mass would be about 1/2g, which is equivalent to a force output of about 5 kips (based on the 10 kip moving mass). At 1/3 Hz., g_{\max} would be about 1/20g and the force output would be about 1/2 kip.

To achieve greater force output by hydraulic devices, two options are available; either increase the weight of the moving mass, or increase the piston stroke. Equipment capabilities suggest that the moving mass should be kept as small as possible, but there are practical constraints on the piston stroke. Although piston strokes greater than 24 inches are achievable, a practical limitation of 24 inches is placed on the piston double amplitude stroke. At 1 Hz., a 24 inch double-amplitude stroke will produce a maximum acceleration of approximately 1 1/4g; but at 1/3 Hz., the level would be about 0.14g and a moving mass of about 143 kips would be needed to produce 20K peak force output. Although this seems like an extremely large moving weight, it represents less than 0.1% of the mass of a ship on the order of the M/V "STEWART J. CORT." Even if five such devices were located on the ship, the total weight of the moving mass would be less than 1/2% of the mass of the ship. The approximate size of a 143 kip moving mass, if made out of steel, would be a cube about 6.6 ft. on a side, and, if made out of concrete, would be a cube about 10 ft. on a side. These are certainly manageable sizes, but the moving mass must be guided vertically so as to prevent deformation of the piston, and damage to the hydraulic seals. This is also needed for safety considerations to prevent toppling of the moving mass.

Another consideration in the design of the electrohydraulic excitation systems are the hydraulic servo valves which control the motions of the piston. These units are rated in terms of the flow of oil required to produce the desired piston motions. An estimate of the flow requirements of the servo valve is given by

$$Q = \frac{A_p f X_{DA}}{1.23} \quad (3-9)$$

where

- Q is the required flow in gallons per minute (gpm)
- A_p is the area of the piston (in.²)
- f is the frequency (Hz.)
- X_{DA} is the piston stroke (in.)

The required piston area A_p is given by:

$$A_p = \frac{F}{P} \quad (3-10)$$

where

- F is the required nominal force
- P is the hydraulic pressure.

Hydraulic pressures of 3,000 psi are common in the industry. For a peak force of 143 kips, a piston area of about 48 in² is needed. The required flow can now be estimated from equation 3-8. For a 24 in. double-amplitude stroke at 1/3 Hz., and a piston area of 48 sq. in., the flow would be approximately 310 gpm. This should be increased about 30% to account for line pressure losses and the compressibility of the flow, giving a required rating of about 400 gpm at 3,000 psi. Servo valves capable of meeting these specifications requirements are in existence.

A final consideration is to determine the size of the hydraulic power supply unit needed. Because the accumulators average the flow, the pump needs to provide only this average flow. For sinusoidal motion, the average flow is 63.7% of the peak flow so the required rating for the hydraulic power supply would be about 256 gallons per minute. Hydraulic power supply units of this capacity exist. The Federal Rail Administration High-Speed Rail Test Facility at Pueblo, Colorado, has employed 7 identical 360 gpm units for dynamic simulation. Figure 3-8 shows one of these units which is estimated to weigh on the order of 10 kips.

The excitation force can be controlled by a closed-loop (feedback) electronic control system. This approach has been used by Baldwin (Reference 3-5), Galambos (Reference 3-6), and many other researchers. Figure 3-9 shows the schematic of the vibration excitation system used by Baldwin on dynamic tests on highway bridges (Reference 3-5). Control of the excitation force is achieved by controlling the relative acceleration of the "moving mass" with respect to the base of hydraulic actuator. The electronic control system contains main and secondary control

Ref. 3-6: Galambos, T. V. and R. L. Mayes, "Dynamic Testing of a Reinforced Concrete Building," Final Report to National Science Foundation, Washington University, Research Report No. 51, Structural Division, June 1978.

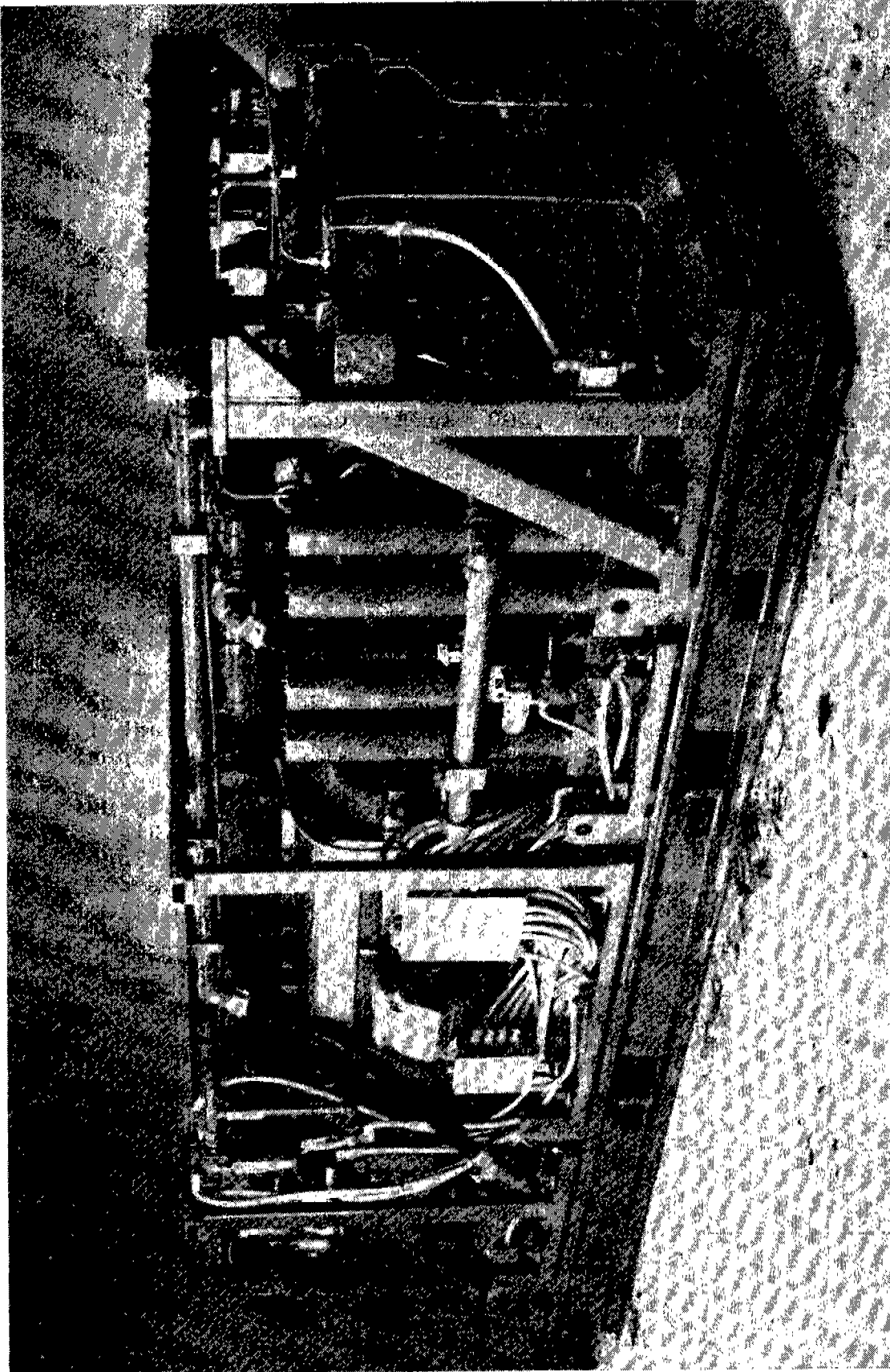

Figure 3-8 360 GMP HYDRAULIC POWER SUPPLY UNIT

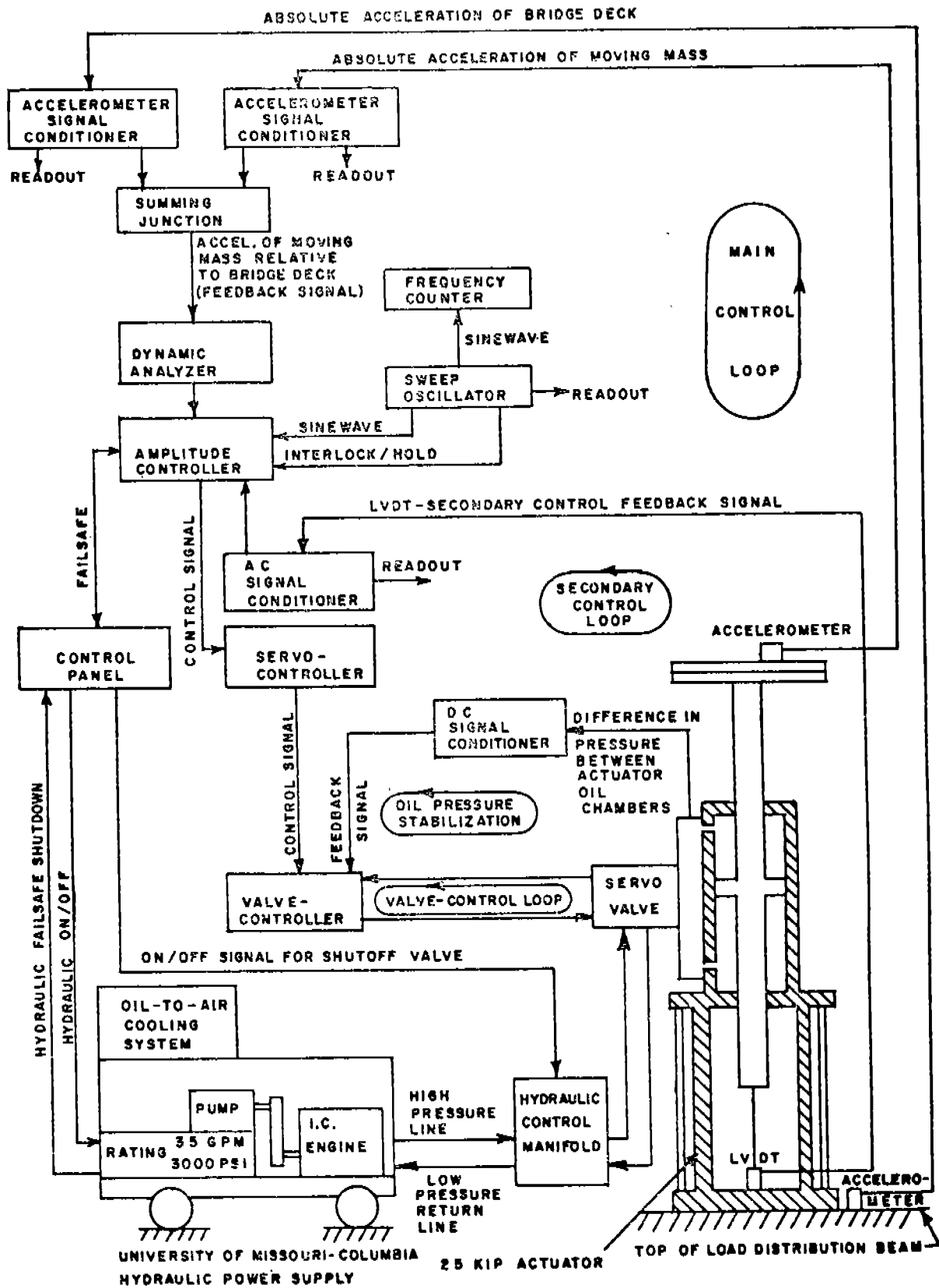

Figure 3-9 SCHEMATIC OF ELECTROHYDRAULIC VIBRATION EXCITATION SYSTEM USED DURING DYNAMIC TESTS OF A HIGHWAY BRIDGE (from Reference 3-5)

loops in which the main control loop is composed of an amplitude controller and the relative acceleration. The secondary control loop is composed of a servo controller and an LVDT (linear variable differential transformer). This system of excitation is adaptable to ship hull vibration testing.

It has been shown that three excitation devices would be needed to obtain meaningful results for the lowest modes, and as many as five may be needed if higher modes of vibration are to be evaluated. These devices would be located along the length of the ship as depicted in Figure 3-1, so, for a long ship, there could be as much as a 900 ft. separation between the extreme exciters. In light of this, two alternative approaches are apparent. One concept is to have each individual excitation device self contained, and to control the phasing and amplitude of the motions electronically. This means that only electrical cable would need to be strung between the exciters (or a remote control system could be used). Alternatively, a larger hydraulic supply unit could be used to power several exciters, and hydraulic servo valves could serve to control and phase the motion. This would require the laying of hydraulic hose between the central hydraulic power unit and each excitation device. The first approach would seem desirable from a practical consideration, especially to avoid cluttering the ship's deck with hydraulic hose, but different opinions have been received on which approach is more controllable. A careful trade-off of these concepts should be performed.

3.7.3.3 Electrodynamic Vibration Generators

In view of the low frequencies desired, and the large displacements needed to produce the required excitation, electrodynamic vibration generators would appear to have little applicability. Generally speaking, the strokes of electrodynamic generators are very small, and although extended stroke devices do exist, their overall performance is inadequate.

3.7.4 Installation Of Excitation Devices On Ships

Structural requirements and space and weight considerations associated with the installment of the excitation devices on ships are presented. This discussion is based on the required excitation, and the electrohydraulic excitation device discussed in previous sections. The following conditions are assumed for purposes of the discussion:

- ° Number of excitation devices needed.....3 to 5
- ° Length of ship being considered.....1,000 ft.
- ° Displacement of ship.....74,000 tons
- ° Maximum force requirements per exciter...20 kip @ 1/3 Hz.

- ° Maximum weight of each moving mass.....143 kips
- ° Approximate size of each moving mass (steel).....6.6 ft. cube
- ° Approximate weight of each hydraulic power supply.....10 kips

3.7.4.1 Structural Requirements

The moving mass must be guided vertically for safety and stability, and to reduce side loads and damage to piston seals. A load frame similar to the one shown in Figure 3-7 is envisioned. The frame shown in Figure 3-7 has a moving mass of 10 kips and a piston stroke of 10 inches double-amplitude. For the proposed application, the frame must be capable of accommodating a piston stroke of 24 inches while stabilizing a moving mass of 142 kips. Based on the capacity of the required actuator, the overall height of the actuator itself would be about 6 ft.; then, allowing 2 ft. for the stroke of the piston, 7 ft. for the size of the moving mass, and 2 ft. for the structural frame at the top and base of the load frame, gives an overall height of approximately 17 feet for the load frame. For stability and to accommodate the 6.6 ft. cube moving mass, the width of the frame should be at least 9 ft. Assuming the same configuration used by Baldwin (Reference 3-5), the approximate dimensions of the hydraulic actuator and load frame are shown in Figure 3-10.

An overall height of 17 feet with the large moving mass being almost that high above the deck isn't very desirable. Two alternate configurations are apparent. Since the hydraulic actuators can act both in tension and compression, the actuator could be located on the top of the frame, with the moving mass hanging below it. The overall height would still be 17 feet, but the moving mass would be a minimum distance above the deck. This would necessitate much heavier vertical members, and a substantial structural means of attaching the mass to the piston. Alternatively, the moving mass need not be a solid cube, and could be donut-shaped with enough space in the hole to accommodate the hydraulic actuator. In this way the overall height could be reduced to about 8 feet, but the frame would be wider.

In theory, it would not be necessary to actually attach the load frame to the ship deck since the "g" levels of the moving mass are always well below 1.0. Some attachment, however, would be needed for safety and stability, and to keep the unit from "walking around" under excitation.

In consideration of the weight of the excitation devices, they should be located over major bulkheads or at ship frames. Structural analysis should be performed to determine if strengthening of the ship structure is needed.

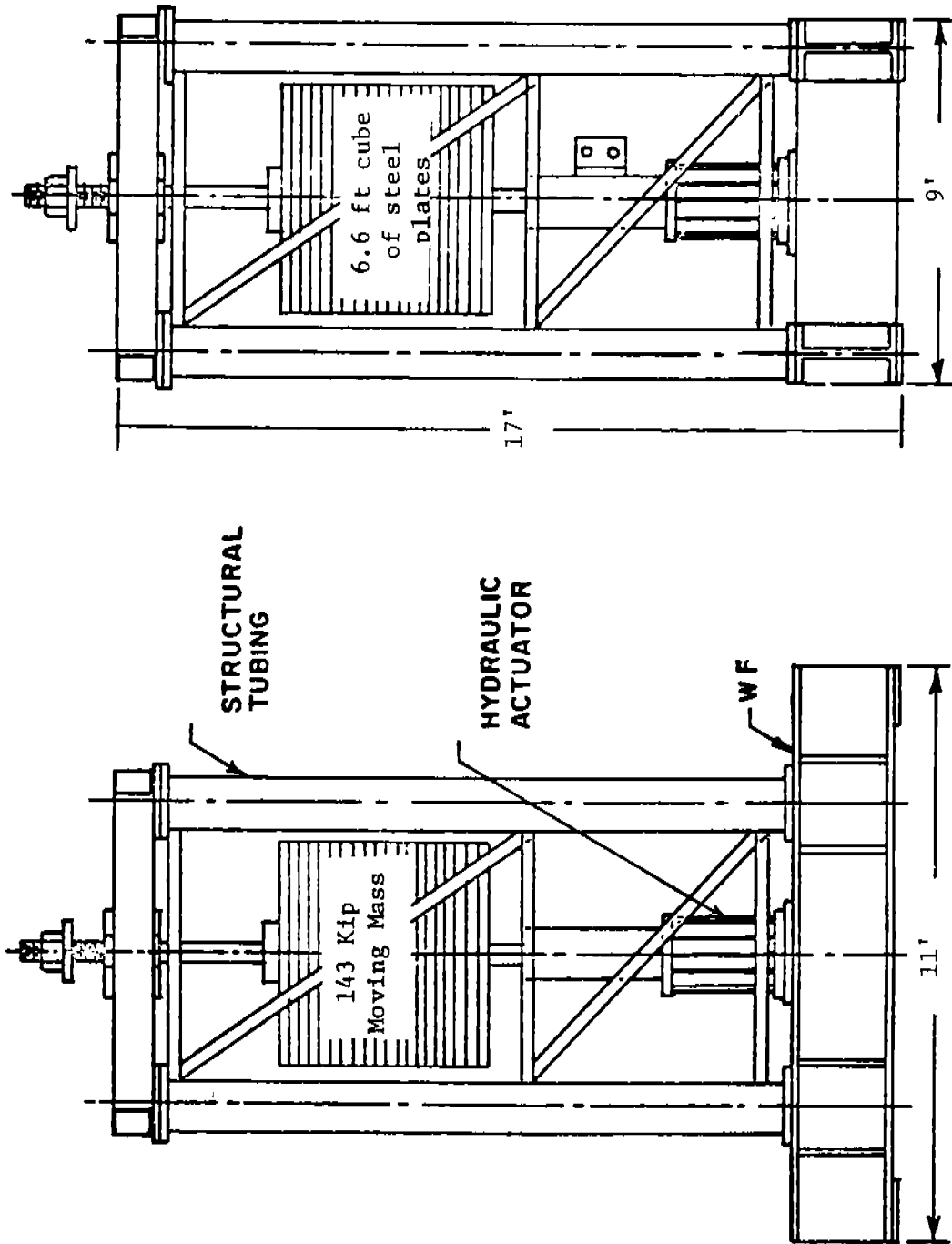

Figure 3-10 HYDRAULIC ACTUATOR AND LOAD DISTRIBUTION FRAME OF A 20k ELECTROHYDRAULIC ACTUATOR (at 1/3 Hz.)

3.7.4.2 Space And Weight Considerations

It is estimated that the total weight of each excitation device, including the load frame and a hydraulic power supply, would be less than 200 kips. If as many as five exciters were to be used on a ship such as the "CORT," the total weight for the apparatus would be less than 1,000 kips which is less than 1% of the displacement of the ship. Due to the large size of the excitation device, and associated hydraulic power supplies, the most convenient place to locate the exciters would be on the open deck. Also since full-scale damping experiments are to be run with and without cargo in the holds, it would not be practical to locate the excitation devices in cargo holds. For purposes of estimating the space requirements for the excitation equipment, the approximate size of the actuator and load frame would be 11 ft. wide by 9 ft. long by 17 ft. high, as shown in Figure 3-10. The approximate size of the hydraulic power supply needed for each actuator would be about 8 ft. wide by 15 ft. long by 8 ft. high, and would weigh on the order of 10 kips. The weather deck of the M/V "STEWART J. CORT" is not cluttered with equipment, and there is more than ample space to locate the excitation equipment on the deck. The locations would be adjusted to avoid hatch openings and to locate exciters over major bulkheads.

3.7.4.3 Effect Of Response Of Local Structure

The vibration characteristics of the load frame, as well as the local ship structure to which the excitation devices are attached, must be taken into consideration. Care must be taken in the design of the load frame to assure that the system has no resonant frequencies in the range over which it is to be operated. In addition, calculations must be performed to assure that there is no resonance between the exciters and the hull girder. By applying the excitation to major structural components, the effects of local structural response can be reduced. Since for most ships the natural frequencies of local structural elements are much higher than the hull girder frequencies, any local response contributions to the overall response can be isolated by filtering the data.

3.7.5 Location And Magnitude Of The Excitation

As previously discussed in reference to the model tests, the location and magnitude of the excitation is determined by equation 2-9. The concept, in essence, is to "tune" the excitation to the ship for each mode of vibration by minimizing the contributions of "off-frequency" modes, while maximizing the in-frequency mode. Preliminary estimates made for the "CORT" indicate that the 2-node mode of vertical hull girder response has a natural frequency of 1/3 Hz. and that if three excitation devices are used the maximum force output required would be 20 kips. This was the basis for the discussion on the sizing of the excitation

devices. The actual maximum force output required for the other two exciters would be less than 20 kips. At higher modes, as many as five excitation devices would be needed, but since the natural frequencies would be higher the required forces would be easier to achieve since the "g" level of the moving mass increases with the square of the frequency (as shown by equation 3-8). The peak sinusoidal force output of the electrohydraulic exciter is:

$$F_{\max} = 0.052f^2 X_{DA}W \quad (3-11)$$

where

W is the weight of the moving mass

X_{DA} is the double-amplitude stroke of the piston

f is the frequency of excitation.

This relationship shows that for a given frequency there are two ways to control the force, either by controlling the stroke of the piston, or by altering the weight of the moving mass. The moving mass could be made of separate steel plates, as was done by Baldwin (Reference 3-5); such that the weight could be adjusted by removing or adding plates. Since the weight of the moving mass and the maximum stroke of the piston must be sized to meet the worst condition, there is no savings in removing weight when lower loads are needed. Also, changing the weight of the moving mass would alter the dynamic characteristics of the exciter from test to test. Since this would not be desirable, it is recommended that the weight of the moving mass remain constant, and the forces be adjusted by controlling the motions of the piston.

Figure 3-11 shows the first five deformation modes of a free-free beam of uniform properties in vertical vibration and shows the approximate locations of the excitation devices to achieve the conditions dictated by equation 2-9. Of course, a real ship will not have uniform properties along the length so the location of the nodes are only conceptual. For a real ship, a vibration study must be performed to determine the location and magnitude of the excitation devices. It is unlikely that the theoretical locations for excitation devices to be installed will fall at major structural frames. The options are to either locate the exciters at the "exact" theoretical position, and fabricate any special foundation needed to get the load into major structural elements, or to move the exciters to the nearest major structural member. The vibration characteristics of such foundations must be estimated to assure that there is no resonance between the excitation systems and the hull girder. Probably, the more practical solution would be to move the exciter to the nearest adequate structural member, and make calculations for adjusting the excitation to account for any effects.

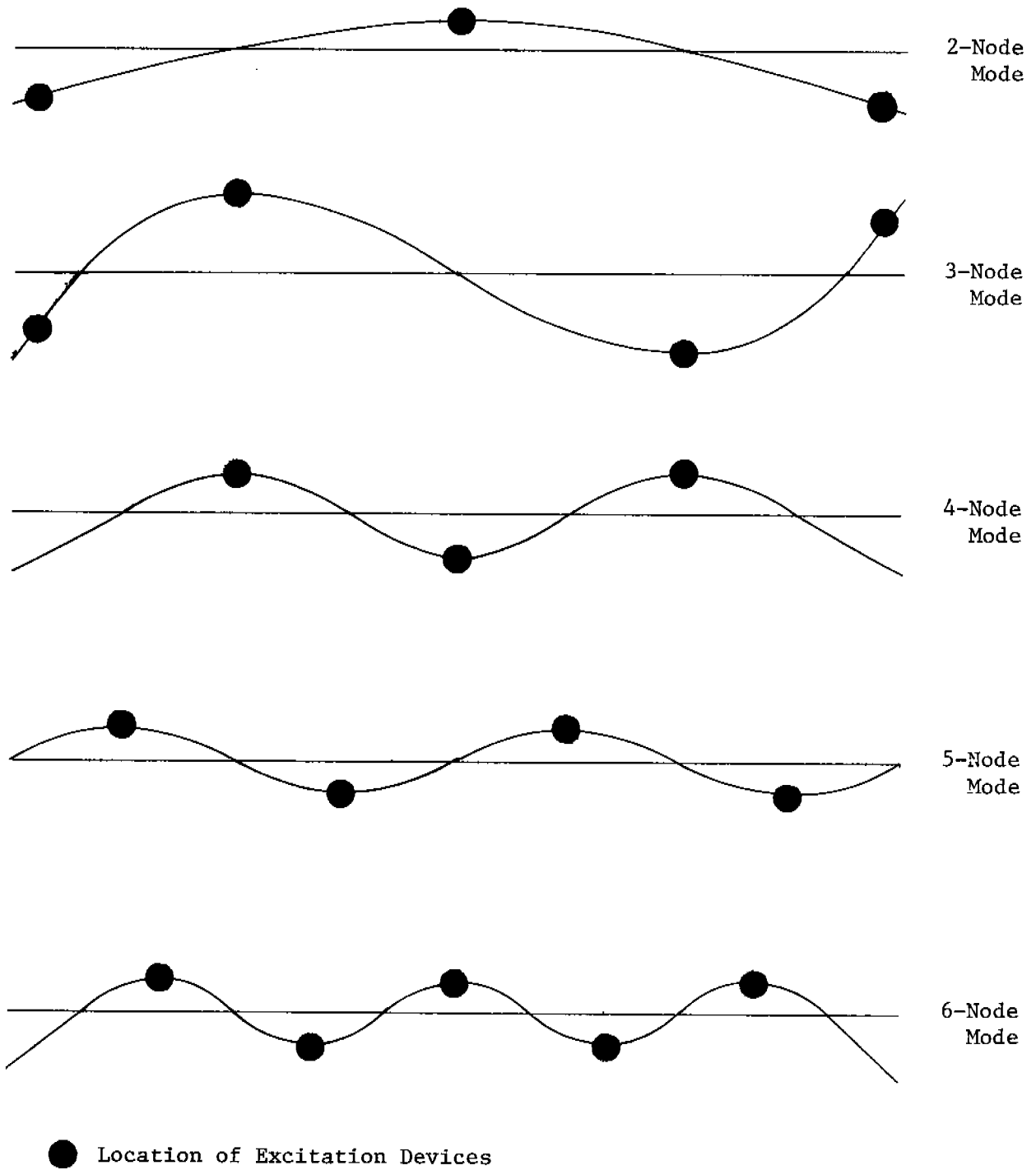

Figure 3-11 APPROXIMATE LOCATION OF EXCITATION DEVICES

3.7.6 Response Calculations And Required Measurements

Response calculations for the full-scale experiments parallel those discussed for model tests and are discussed in Section 3.4. The required measurements are similar to the model tests.

1. A frequency survey to determine the first ten natural frequencies of the ship
2. Under steady-state conditions for the first five frequencies:
 - a. Measure the acceleration at enough points along the hull so that a continuous curve of accelerated can be plotted. From this curve, the deflection and velocity curves can be constructed.
 - b. Measure the bending and shear stress at enough points along the girth of a section of the ship so that the bending moment and shear force at those sections can be calculated.
3. Under transient conditions following the sudden stopping of the excitation perform the same measurements as noted in a. and b. above.

3.7.7 Test Program

The test program is to be conducted for the ship both stationary, and with forward speed, and for the ship both with and without cargo. For all conditions the ship should be ballasted to give the same displacement. Variable cargo type should be considered including bulk minerals (iron ore), oil, bulk grain, bagged cargo and miscellaneous cargo. For the tests conducted in still water, the effect of the depth of water should be evaluated as discussed in Section 3.6.1. Since most docking facilities are quite shallow, this could become a problem.

4.0 SUMMARY

A survey of the theories used for the calculation of the vibratory response of ship hulls, and a review of available data for damping coefficients has revealed that existing damping data are not adequate for making reliable predictions. Also, the influence of forward speed on hydrodynamic damping parameters, and hull natural frequencies has been shown to be an unsettled matter. The deficiencies of past damping experiments have been identified in the interest of developing an experimental plan which will produce the required damping data. In order to make reliable vibration calculations, the distribution of the damping throughout the ship is needed, as well as the breakdown of the damping into its three basic components; structural damping, hydrodynamic damping, and cargo damping. Also, the dependency of the various damping components on the vibratory frequencies must be isolated. Previous transient and steady-state response tests have failed to produce data suitable for determining these attributes of the damping. Coupling of the modes of vibration (due to the damping) has prevented extraction of the needed data. Also, in most cases, the excitation was not large enough to give response measurements from which the effects of the response of local structure and other experimental disturbances could be isolated.

The concept developed to eliminate the deficiencies of previous tests cited above is to "tune" the excitation to the ship for each mode of vibration (of interest), by minimizing the contributions of "off-frequency" mode. The mathematical basis for this concept has been developed along with techniques for calculating the required excitation. Three to five excitation devices were shown to be needed, and estimates were obtained for the required force output needed to excite the lowest modes of a large (74,000 ton) Great Lakes ore carrier and a smaller (30,000 ton) container ship. Excitation devices capable of producing the required excitation were conceptually designed in order to establish the technical feasibility of the approach. The costs associated with the full-scale experiments would depend upon many factors. The cost, and availability for testing, of candidate ships would have a significant impact on the cost. The electrohydraulic excitation devices, along with hydraulic power supply units and control devices would have a prohibitive cost if purchased specifically for the hull damping experiments. Opinions from various manufacturers of the hydraulic equipment of the possible cost of purchasing the required apparatus, have varied widely. This matter should be explored in more depth to obtain reasonable cost estimates. In Section 3, several tests conducted with similar electrohydraulic devices have been cited (for example, Baldwin, Reference 3-5, and Galambos, Reference 3-6). In addition, there are several facilities in this country which utilize large electrohydraulic actuators, and have hydraulic power units and control devices which may be able to satisfy the needs

of the full-scale damping experiments. Among these are the U.S. Army Corps of Engineers Construction Engineering Research Laboratory (C.E.R.L.), Seismic Simulation Facility, and the Federal Rail Administration High-Speed Rail Test Facility at Pueblo, Colorado. There are undoubtedly several other facilities in existence, and the thought occurs that it may be possible to use some of this equipment for the damping tests. No exhaustive search of such facilities has been made, nor have any inquiries been made of the prospects that this equipment may not be being used full-time and may be available for the full-scale damping tests, nor has the technical feasibility of moving such equipment been explored. The topic is broached, however, to point out that there may be cost-effective options available for implementing the damping tests. Also, many commercial testing companies and suppliers of electrohydraulic devices may have some if not all of the required equipment and may be willing to rent it out, or even contract to provide the services, without requiring that the equipment be purchased. In short, there are many ways in which the full-scale experiments might be implemented and the costs would vary considerably.

Model tests have been recommended to determine the hydrodynamic damping parameters and possibly the effects of forward speed on hull damping and response frequencies. The detail design of models would depend on the test facility being used, so the design of the models has been addressed only on a conceptual basis.

The required measurements have been outlined, and methods for extracting the needed damping data from the experimental data have been presented. The kinds of measurements that need to be made (accelerations, bending moments, and the time histories of these parameters) have been made on ship and models in the past so no new technology is needed.

A recommendation has been made that an analytical investigation be conducted into the effects of forward speed to settle certain issues prior to implementing the test program.

The recommended program will provide vibration analysts and ship designers with much needed damping data, and the state-of-the-art in ship vibration analysis will be greatly advanced.

5.0 REFERENCES

- 1-1 Woolam, W. E., "Research on Ship-Hull Damping Coefficients for Low-Frequency Vertical Flexural Modes of Variation," Naval Ship Research & Development Center Report No. 2323, May 1967.
- 1-2 McGoldrick, R. T., "Comparison Between Theoretically and Experimentally Determined Natural Frequencies and Modes of Vibration of Ships," DTMB Report 906, August 1954.
- 1-3 McGoldrick, R. T., "Comments on Some of the Fundamental Physical Concepts in Naval Architecture," DTMB Report 1609, April 1962.
- 1-4 Betts, C. V., Reid Bishop and W. G. Price, "A Survey of Internal Hull Damping," RINA, 1976.
- 1-5 Tomita, T., "Allowable Exciting Force or Moment of Diesel Marine Engine," Trans. SNAJ, Vol. 108, 1960 (see also Proc. 2nd ISSC (Committee 9), Delft, 1964).
- 1-6 Volcy, G. C., "L'Amortissement dans les Vibration des Navires," Nonveantes Techniques Maritime, 1978 (in French).
- 1-7 Yamamoto, Y. and M. Arita, "Damping Forces in Ship Vibration," Trans. SNAJ, Vol. 118, 1965, p. 138.
- 1-8 Johnson, A. J., "Vibration Tests of an All-welded and an All-riveted 10,000 Ton Dry Cargo Ship," Trans. NECLIES, Vol. 67, 1951, pp. 205-276.
- 1-9 Sezawa, K. and W. Watanabe, "Damping Forces in Vibration of a Ship," Journal of Society of Naval Architects, Japan, No. 59, 1936.
- 1-10 Betts, C. V., "On the Damping of Ship Hulls," M.Phil. Thesis, London University, 1975.
- 1-11 Robinson, D. C., "Damping Characteristics of Ships in Vertical Flexure and Considerations in Hull Damping Investigation," DTMB Report No. 1876, December 1964.
- 1-12 Kumai, T., "Damping Factors in the Higher Modes of Ship Vibration," European Shipbuilding, Vol. VII, No. 1, 1968.
- 1-13 Borg, S. F., "The Analysis of Ship Structures Subjected to Slamming Loads," Journal of Ship Research, 4, No. 3, pp. 11-27, 1960.

- 1-14 Salvesen, N., E. O. Tuck and O. Faltinsen, "Ship Motions and Sea Loads," Transactions SNAME, 1970.
- 1-15 Goodman, R. A., "Wave-Excited Main Hull Vibration in Large Tankers and Bulk Carriers," RINA, 1971.
- 1-16 Beals, V. L. and S. R. Hurley, "The Application of Impulsive Excitation to In-Flight Vibration Testing," Aerospace Engineering 20, No. 1, January 1961.
- 1-17 Buchmann, E. and R. G. Tuckerman, "Model Basin Procedure for the Analysis and Presentation of Vibration Data," Shock, Vibration and Associated Environments, Bulletin No. 33, February 1964.
- 1-18 Foster, W. P. and H. F. Alma, "Damping Values of Naval Ships Obtained from Impulse Loadings," Shock d'Vibration Bull. #40, December 1969.
- 1-19 Salvesen, N., E. O. Tuck and O. Faltinsen, "Ship Motions and Sea Loads," Transactions SNAME, 1971.
- 1-20 Hoffman, D., et al., "Experimental and Theoretical Evaluation of Springing on a Great Lakes Bulk Carrier," AD-776861, July 1973.
- 1-21 Goodman, R. A., "Wave-Excited Main Hull Vibration in Large Tankers and Bulk Carriers," RINA, 1971.
- 2-1 Noonan, E. F., "Design Considerations for Shipboard Vibration," presented at the February 17, 1970 meeting of the New York Section of SNAME.
- 2-2 Kline, R., "Springing and Hydroelastic Problems of Large Ships," August 26-29, 1975, SNAME.
- 2-3 McGoldrick, R. T., "Ship Vibration," DTNSRDC Report 1451, December 1960.
- 2-4 Stiansen, S. G., A. Mansour and Y. N. Chen, "Dynamic Response of Large Great Lakes Bulk Carriers to Wave-Excited Loads," Transactions of SNAME, 1977.
- 2-5 Foltinsen, O. M., "A Numerical Investigation of the Ogilvie-Tuck Formulas for Added-Mass and Damping Coefficients," Journal of Ship Research, June 1974.
- 2-6 Korvin-Kroukovsky, V. V. and W. R. Jacobs, "Pitching and Heaving Motions of a Ship in Regular Waves," Transactions of SNAME, Vol. 65, 1957.

- 2-7 Salvesen, N., E. O. Tuck and O. Faltinsen, "Ship Motions and Sea Loads," Transactions SNAME, 1971.
- 2-8 Ogilvie, T. F. and E. O. Tuck, "A Rational Strip-Theory of Ship Motion - Part I," The University of Michigan, Report No. 013, 1969.
- 2-9 Pilkey, W. D. and P. Y. Chang, "Modern Formulas for Statics and Dynamics -- A Stress-and-Strain Approach," McGraw-Hill Book Company, 1978.
- 2-10 Chang, P. Y., "Structural Analysis of Cold Water Pipes for Ocean Thermal Energy Conversion Power Plants," Hydronautics, Inc., TR No. 7676, May 1977.
- 2-11 Chang, P. Y., "The Effects of Varying Ship Hull Proportions and Hull Materials Vibratory Stresses," Hydro-nautics, Inc., TR 7715-1, September 1978, SSC-288, 1979.
- 2-12 Vings, J. H., "The Hydrodynamic Coefficients for Swaying, Heaving and Rolling Cylinders in a Free Surface," TNO Report No. 112S, May 1968.
- 2-13 Betts, C. V., R. E. D. Bishop and W. G. Price, "A Survey of Internal Hull Damping," RINA, 1976.
- 3-1 Dinsenbacher, A. L., "Experimental Methods in Ship Structural Evaluation," Ship Structure Symposium 75, 1975.
- 3-2 Austin, S. L., "Design History of the Rigid Vinyl Model of Hydrofoil Plainview (AGEH-1)," DTNSRDC Report 3883, October 1972.
- 3-3 Rodd, J. L., "Verification of the Rigid Vinyl Modeling Technique: The SL-7 Structure," SSC-259, 1976.
- 3-4 Volcy, G. C., "L'Amortissement dans les Vibration des Navires," Nonveantes Techniques Maritime, 1978.
- 3-5 Baldwin, J. W., et al., "Fatigue Test of a Three-Span Composite Highway Bridge," Missouri Cooperative Highway Research Program Final Report 73-1, June 1978.
- 3-6 Galambos, T. V. and R. L. Mayes, "Dynamic Testing of a Reinforced Concrete Building," Final Report to National Science Foundation, Washington University, Research Report No. 51, Structural Division, June 1978.

APPENDIX A

DESCRIPTION OF ROTATING-MASS VIBRATION GENERATORS

(1) TMB 40,000-Pound, Three-Mass Vibration Generator

Principle of Operation

Unidirectional forces or moments are obtained by unbalancing three rotating masses in a common plane. There are three 2,000-lb. weights whose centers of gravity can be displaced 6 inches from the center of rotation.

Components

Force Generating Unit
Motor-Generator Set
Operator Control Console
Small Portable Air Compressor

Descriptive Data

Overall Dimensions:	Length 108 in. Width 60 in. Height 44 in.
Weight/Mechanical Unit:	12,500 lbs.
Frequency Range:	0.66-20 Hz.
Maximum Force:	40,000 lbs.

Comments

This is a one-of-a-kind unit, built in the 1940's for David Taylor Model Basin and is presently being stored at DTNSRDC in Carderock, Maryland. It has not been used in about 10 years but appears to be in good condition.

(2) TMB 5,000-Pound, Three-Mass Vibration Generator

Principle of Operation

Unidirectional forces and moments are obtained by unbalancing and phasing three rotating masses in a common plane. There are three 200-lb. weights and the center of gravity of each weight can be displaced by a maximum of 3.5 inches from the center of rotation.

Components

Vibration Generator
Drive Motor
Amplidyne Generator Set
Amplidyne Generator Starting Panel
Speed Control Panel
Small Portable Air Compressor

Descriptive Data

Overall Dimensions:	Length 63 in.
	Width 12 in.
	Height 16 in.
Weight/Mechanical Unit:	2,000 lbs.
Frequency Range:	0.416-33 1/3 Hz.
Maximum Force:	5,000 lbs.

Comments

This is a one-of-a-kind unit, which was built in the 1940's for David Taylor Model Basin and is currently stored at DTNSRDC in Carderock, Maryland. It was used a few years ago, and appears to be in good condition.

(3) L.A.B. Type RVCG-10,000-Pound Vibration Exciter System

Principle of Operation

Each exciter employs two counter-rotating shafts to resolve their orbital forces into a straight line vector. On each of the shafts there are two opposing cylinders with an interconnecting passage between them. One cylinder is filled with mercury to produce unbalance, and the opposite cylinder is charged with nitrogen gas pressure which allows the degree of unbalance, and consequently, the force, to be controlled while the generator is running. The system consists of two generators which can be operated in synchronism with precise control, while the exciters are spaced up to 100 ft. away from the console in any direction.

Components

Two Vibration Generators
Control Console
Motor/Alternator Drive System
Electrical Differential Unit
Nitrogen Gas Supply (500 psi)

Descriptive Data

Overall Dimensions: Length 51 in.
 Width 32 in.
 Height 23½ in.

Weight/Each Exciter: 729 lbs.

Frequency Range: 0.6-50 Hz. (in 6 steps)

Maximum Force Output: 10,000 lbs. (each exciter)

Comments

This system was specially built for the Federal Highway Administration, Office of Research and Development, for testing highway bridges in the late 1960's. There is only one system in existence, which is located at the FHWA Fairbank Highway Research Station in McLean, Virginia. The system appears to be in good condition, and was last used a few years ago.

(4), (5), (6) and (7) L.A.B. Portable Mechanical Vibration Exciters

Principle of Operation

The exciters produce vibrations by two counter rotating shafts with eccentric weights. The eccentric weights are adjustable to permit changing the force output without affecting frequency. The exciters are driven with either AC single speed motors or variable speed DC motors, with flexible drive shafts.

Components

Vibration Exciters
Drive Motor
Speed Controls

Descriptive Data

	(4)	(5)	(6)	(7)
	LAB B	LAB A	LAB AA	LAB C
Overall Dimensions:				
Length (in.)	27½	18¼	14¼	22
Width (in.)	7	6	5	9
Height (in.)	9 3/4	7 5/8	5 5/8	10
Weight (Exciter) (lbs.)	140	77	35	230
Maximum Force Output (continuous) (lbs.):	8,000	4,000	2,000	12,000
Frequency Range (Hz.):	100	100	100	60

Comments

These vibrators have been used by NSRDC on ship vibrations tests. The following exciters currently are stored at NSRDC, Carderock, Maryland, and are in working condition:

LAB "C"
LAB "B"
LAB "A"
LAB "AA"

SHIP RESEARCH COMMITTEE
Maritime Transportation Research Board
National Academy of Sciences - National Research Council

The SHIP RESEARCH COMMITTEE has technical cognizance of the interagency Ship Structure Committee's research program.

Mr. A. D. Haff, Chairman, *Consultant, Annapolis, MD*
Prof. A. H.-S. Ang, *Civil Engrg. Dept., University of Illinois, Champaign, IL*
Dr. K. A. Blenkarn, *Research Director, Offshore Technology, Amoco Production Company, Tulsa, OK*
Mr. D. Price, Sr. *Systems Analyst, National Oceanic and Atmospheric Administration, Rockville, MD*
Mr. D. A. Sarno, *Manager-Mechanics, ARMO Inc., Middletown, OH*
Prof. H. E. Sheets, *Dir. of Engineering, Analysis & Technology, Inc., Stonington, CT*
Mr. J. E. Steele, *Naval Architect, Quakertown, PA*
Mr. R. W. Rumke, *Executive Secretary, Ship Research Committee*

The SHIP DESIGN, RESPONSE, AND LOAD CRITERIA ADVISORY GROUP prepared the project prospectus and evaluated the proposals for this project.

Mr. J. E. Steele, Chairman, *Naval Architect, Quakertown, PA*
Mr. J. W. Boylston, *Consulting Naval Architect, Giannotti & Associates, Inc., Annapolis, MD*
Prof. R. G. Davis, *Assistant Professor of Naval Architecture, Dept. of Marine Engrg., Texas A&M University, Galveston, TX*
Mr. P. W. Marshall, *Civil Engineering Advisor, Shell Oil Company, Houston, TX*
Prof. R. Plunkett, *Dept. of Aerospace Engrg. and Mechanics, University of Minnesota, Minneapolis, MN*
Mr. C. B. Walburn, *Assistant Naval Architect, Bethlehem Steel, Corp., Marine Division, Sparrows Point, MD*

The SHIP-VIBRATION-RELATED PROJECTS ADVISORY COMMITTEE provided the liaison technical guidance, and reviewed the project reports with the investigator.

Mr. E. F. Noonan, Chairman, *Consultant, Annapolis, MD*
Mr. R. A. Babcock, *Senior Supervisor, General Dynamics, Quincy, MA*
Dr. E. Buchmann, *Consultant, Bethesda, MD*
Dr. B. L. Silverstein, *Naval Architect, Technology Applications, Inc., Falls Church, VA*
Mr. W. A. Wood, *Naval Architect, Giannotti & Associates, Inc., Annapolis, MD*

SHIP STRUCTURE COMMITTEE PUBLICATIONS

These documents are distributed by the National Technical Information Service, Springfield, VA 22314. These documents have been announced in the Clearinghouse Journal U. S. Government Research & Development Reports (USGRDR) under the indicated AD numbers.

- SSC-300, *Summary of Nondestructive Inspection Standards for Heavy Section Castings, Forgings, and Weldments* by R. A. Youshaw. 1980. AD-A099119.
- SSC-301, *Probabilistic Structural Analysis of Ship Hull Longitudinal Strength* by J. C. Daidola and N. S. Basar. 1981. AD-A099118.
- SSC-302, *Computer-Aided Preliminary Ship Structural Design* by A. E. Marsow and A. Thayamballi. 1981. AD-A099113.
- SSC-303, *Fatigue and Fracture Toughness Characterization of SAW and SMA A537 Class I Ship Steel Weldments* by J. F. Souak, J. W. Caldwell, and A. K. Shoemaker. 1981.
- SSC-304, *SL-7 Extreme Stress Data Collection and Reduction* by E. T. Booth. 1981.
- SSC-305, *Investigation of Steels for Improved Weldability in Ship Construction - Phase II* by B. G. Reisdorf and W. F. Domis. 1981.
- SSC-306, *Experimental Program for the Determination of Hull Structural Damping Coefficients* by P. Y. Chang and T. P. Carroll. 1981.
- SSC-307, *Evaluation of Fracture Criteria for Ship Steels and Weldments* by A. W. Pense. 1981.
- SSC-308, *Criteria for Hull-Machinery Rigidity Compatibility* by W. I. H. Budd, S. V. Karve, J. G. de Oliveira, and P. C. Xirouchakis. 1981.
- SSC-309, *A Rational Basis for the Selection of Ice Strengthening Criteria for Ships - Vol. I* by J. L. Coburn, F. W. DeBord, J. B. Montgomery, A. M. Nawwar, and K. E. Dane. 1981.
- SSC-310, *A Rational Basis for the Selection of Ice Strengthening Criteria for Ships - Vol. II - Appendices* by J. L. Coburn, F. W. DeBord, J. B. Montgomery, A. M. Nawwar, and K. E. Dane. 1981.
- SSC-311, *Evaluation of SL-7 Scratch-Gauge Data* by J. C. Oliver. 1981.
- SSC-312, *Investigation of Internal Corrosion and Corrosion-Control Alternatives in Commercial Tankships* by L. C. Herring, Jr. and A. N. Titcomb. 1981.
- SSC-313, *SL-7 Research Program Summary, Conclusions and Recommendations* by K. A. Stambaugh and W. A. Wood. 1981.