

SSC-321

**SURVEY OF EXPERIENCE USING REINFORCED CONCRETE
IN FLOATING MARINE STRUCTURES**

SSC-321 SURVEY OF EXPERIENCE USING REINFORCED CONCRETE IN FLOATING MARINE STRUCTURES 1984

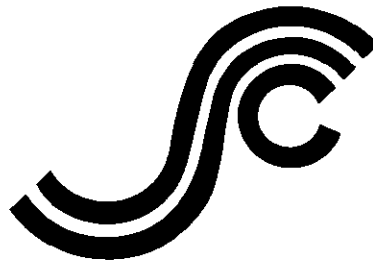

This document has been approved
for public release and sale; its
distribution is unlimited

SHIP STRUCTURE COMMITTEE

1984

1/2" TO TRIM

Member Agencies:

- United States Coast Guard
- Naval Sea Systems Command
- Maritime Administration
- American Bureau of Shipping
- Military Sealift Command
- Minerals Management Service

1" TO BIND



Ship Structure Committee

Address Correspondence to:

Secretary, Ship Structure Committee
 U.S. Coast Guard Headquarters, (G-M/TP 13)
 Washington, D.C. 20593
 (202) 426-2197

An Interagency Advisory Committee
 Dedicated to the Improvement of Marine Structures SR-1270

As the Ship Structure Committee has broadened its scope of projects in the past decade, materials other than steel have been addressed. Of importance to the marine community is the use of concrete for certain applications where concrete is determined to be cost effective.

This report reviews applications of marine concrete structures, research into concrete structures, inspection and repair of these structures and presents an extended bibliography on this topic.

CLYDE T. LUSK, Jr.
 Rear Admiral, U.S. Coast Guard
 Chairman, Ship Structure Committee

486-328

①

② BLANK

86 1/2%

| | | | | | |
|---|--|--|---|---|-----------|
| 1. Report No. SSC-321 | | 2. Government Accession No. | | 3. Recipient's Catalog No. | |
| 4. Title and Subtitle SURVEY OF EXPERIENCE USING REINFORCED CONCRETE IN FLOATING MARINE STRUCTURES | | | | 5. Report Date 1983 | |
| | | | | 6. Performing Organization Code 06-5911 | |
| 7. Author(s) O. H. Burnside and D. J. Pomerening | | | | 8. Performing Organization Report No. | |
| 9. Performing Organization Name and Address Southwest Research Institute 6220 Culebra Road, P. O. Drawer 28510 San Antonio, Texas 78284 | | | | 10. Work Unit No. (TRAIS) | |
| | | | | 11. Contract or Grant No. DOT-CG-919837-A | |
| 12. Sponsoring Agency Name and Address Commandant (G-FCP-2/TP64) U. S. Coast Guard Washington, D.C. 20590 | | | | 13. Type of Report and Period Covered Final Report November 1979 - March 1983 | |
| | | | | 14. Sponsoring Agency Code SR-1270 | |
| 15. Supplementary Notes The USCG acts as the contracting office for the Ship Structure Committee | | | | | |
| 16. Abstract This report traces the application of concrete in floating marine structures from its first use in the 1800's to the present day. The various applications were discussed with respect to design, construction, materials, and service experience. This report also reviews recent and current research programs, both in the United States and abroad, which address the use of concrete in fixed and floating marine structures. From the knowledge of applications and research activities, certain technology areas are identified as requiring additional research if advances are to be made in the use of concrete for floating marine structures. A plan is outlined for developing these identified needs into future Ship Structure Committee programs. | | | | | |
| 17. Key Words concrete (pretensioned, Posttensioned Ferrocement Floating Concrete Structures Ships Barges Offshore Platforms | | | 18. Distribution Statement This document is available to the U.S. Public through the National Technical Information Service, Springfield, VA 22161 | | |
| 19. Security Classif. (of this report) UNCLASSIFIED | | 20. Security Classif. of this page UNCLASSIFIED | | 21. No. of Pages 241 | 22. Price |

8/6/79

METRIC CONVERSION FACTORS

Approximate Conversions to Metric Measures

| Symbol | When You Know | Multiply by | To Find | Symbol |
|----------------------------|-------------------------|----------------------------|---------------------|-----------------|
| LENGTH | | | | |
| in | inches | 2.5 | centimeters | cm |
| ft | feet | 30 | centimeters | cm |
| yd | yards | 0.9 | meters | m |
| mi | miles | 1.6 | kilometers | km |
| AREA | | | | |
| in ² | square inches | 6.5 | square centimeters | cm ² |
| ft ² | square feet | 0.09 | square meters | m ² |
| yd ² | square yards | 0.8 | square meters | m ² |
| mi ² | square miles | 2.6 | square kilometers | km ² |
| | acres | 0.4 | hectares | ha |
| MASS (weight) | | | | |
| oz | ounces | 28 | grams | g |
| lb | pounds | 0.46 | kilograms | kg |
| | short tons (2000 lb) | 0.9 | tonnes | t |
| VOLUME | | | | |
| tsp | teaspoons | 5 | milliliters | ml |
| Tbsp | tablespoons | 15 | milliliters | ml |
| fl oz | fluid ounces | 30 | milliliters | ml |
| c | cups | 0.24 | liters | l |
| pt | pints | 0.47 | liters | l |
| qt | quarts | 0.95 | liters | l |
| gal | gallons | 3.8 | liters | l |
| ft ³ | cubic feet | 0.03 | cubic meters | m ³ |
| yd ³ | cubic yards | 0.76 | cubic meters | m ³ |
| TEMPERATURE (exact) | | | | |
| °F | Fahrenheit temperature | 5/9 (after subtracting 32) | Celsius temperature | °C |

*1 in = 2.54 (exactly). For other exact conversions and more detailed tables, see NBS Misc. Publ. 286, Units of Weights and Measures, Price \$2.25, SD Catalog No. C13.10:286.



Approximate Conversions from Metric Measures

| Symbol | When You Know | Multiply by | To Find | Symbol |
|----------------------------|-----------------------------------|-------------------|------------------------|-----------------|
| LENGTH | | | | |
| mm | millimeters | 0.04 | inches | in |
| cm | centimeters | 0.4 | inches | in |
| m | meters | 3.3 | feet | ft |
| m | meters | 1.1 | yards | yd |
| km | kilometers | 0.6 | miles | mi |
| AREA | | | | |
| cm ² | square centimeters | 0.16 | square inches | in ² |
| m ² | square meters | 1.2 | square yards | yd ² |
| km ² | square kilometers | 0.4 | square miles | mi ² |
| ha | hectares (10,000 m ²) | 2.5 | acres | |
| MASS (weight) | | | | |
| g | grams | 0.035 | ounces | oz |
| kg | kilograms | 2.2 | pounds | lb |
| t | tonnes (1000 kg) | 1.1 | short tons | |
| VOLUME | | | | |
| ml | milliliters | 0.03 | fluid ounces | fl oz |
| l | liters | 2.1 | pints | pt |
| l | liters | 1.06 | quarts | qt |
| l | liters | 0.26 | gallons | gal |
| m ³ | cubic meters | 35 | cubic feet | ft ³ |
| m ³ | cubic meters | 1.3 | cubic yards | yd ³ |
| TEMPERATURE (exact) | | | | |
| °C | Celsius temperature | 9/5 (then add 32) | Fahrenheit temperature | °F |

9/5

IV

486-3284

IV

TABLE OF CONTENTS

| <u>Section</u> | <u>Page</u> |
|---|-------------|
| LIST OF ILLUSTRATIONS | vii |
| LIST OF TABLES | ix |
| 1.0 INTRODUCTION | 1.1 |
| 1.1 Overview of Program | 1.1 |
| 1.2 Brief History of Reinforced Concrete in Floating Marine Structures | 1.2 |
| REFERENCES | 1.6 |
| 2.0 <u>STATE-OF-THE-ART REVIEW</u> | 2.1 |
| 2.1 Overview | 2.1 |
| 2.2 Major Information Sources | 2.4 |
| REFERENCES | 2.12 |
| 3.0 APPLICATIONS AND EXPERIENCE | 3.1 |
| 3.1 Overview | 3.1 |
| 3.2 U.S. Concrete Ships Built During World War II | 3.1 |
| 3.2.1 Background | 3.1 |
| 3.2.2 General Descriptions of Hulls | 3.3 |
| 3.2.3 Design Considerations | 3.8 |
| 3.2.4 Materials and Construction | 3.12 |
| 3.2.5 Proving the Designs | 3.16 |
| 3.2.6 Construction Costs | 3.18 |
| 3.2.7 Service And Experience | 3.18 |
| 3.3 CONDEEP North Sea Platforms | 3.21 |
| 3.3.1 Background | 3.21 |
| 3.3.2 Main Features of the CONDEEP Structures | 3.21 |
| 3.3.3 Design Considerations | 3.25 |
| 3.3.4 Construction Procedure | 3.31 |
| 3.3.5 Materials | 3.35 |
| 3.3.6 Experience | 3.40 |
| 3.4 Concrete Ships Built During World War I | 3.42 |
| 3.5 Other Fixed Structures | 3.44 |
| 3.5.1 Ekofisk One | 3.44 |
| 3.5.2 Gulf of Mexico Gravity Structures | 3.48 |
| 3.5.3 Permanently Moored Barges | 3.48 |

TABLE OF CONTENTS (Cont'd.)

| <u>Section</u> | <u>Page</u> |
|--|-------------|
| 3.5.3.1 ARCO LPG Floating Facility | 3.48 |
| 3.5.3.2 Japanese Barge Programs | 3.51 |
| 3.6 Harbor and Coastal Structures | 3.52 |
| 3.6.1 Harbors and Docks | 3.52 |
| 3.6.2 Bridges | 3.54 |
| 3.7 Barge Studies | 3.58 |
| 3.7.1 Background | 3.58 |
| 3.7.2 Comparison of Design | 3.60 |
| 3.7.3 Comparison of Margins of Safety | 3.65 |
| 3.7.4 Fatigue Characteristics of Concrete Hulls | 3.67 |
| 3.7.5 Summary of Barge Designs | 3.67 |
| 3.8 Floating Platform Studies | 3.68 |
| 3.8.1 General | 3.68 |
| 3.8.2 Arctic Caisson Design | 3.68 |
| 3.8.2.1 Overview | 3.68 |
| 3.8.2.2 Ice Forces | 3.72 |
| 3.8.2.3 Model Tests | 3.72 |
| 3.8.2.4 Arctic Caisson Results | 3.74 |
| REFERENCES | 3.75 |
| 4.0 SUMMARY OF RESEARCH ACTIVITIES | 4.1 |
| 4.1 Introduction | 4.1 |
| 4.2 United States | 4.2 |
| 4.2.1 American Concrete Institute | 4.2 |
| 4.2.2 Portland Cement Association | 4.3 |
| 4.2.3 Concrete Laboratory, U.S. Army Engineer Waterways Experiment Station (WES) | 4.3 |
| 4.3 United Kingdom | 4.7 |
| 4.3.1 United Kingdom's Science Research Council (SRC) Marine Technology Program [4.8] | 4.7 |
| 4.3.2 Concrete in the Oceans Program | 4.10 |
| 4.3.3 Cement and Concrete Association | 4.10 |
| 4.4 Netherlands Industrial Council for Oceanology (IRO) Program | 4.17 |

TABLE OF CONTENTS (Cont'd.)

| <u>Section</u> | <u>Page</u> |
|--|-------------|
| 4.5 Norway | 4.21 |
| 4.5.1 Det norske Veritas (DnV) | 4.21 |
| 4.5.2 Norwegian Institute of Technology (NTH)/ The Foundation of Scientific and Industrial Research (SINTEF) | 4.31 |
| 4.5.2.1 Norwegian Institute of Technology | 4.31 |
| 4.5.2.2 The Foundation of Scientific and Industrial Research at the Norwegian Institute of Technology | 4.35 |
| 4.5.3 Norwegian/German COSMAR Program | 4.36 |
| 4.6 Treat Island, Maine, Concrete Exposure Station | 4.37 |
| 4.6.1 Description of the Test Facility | 4.37 |
| 4.6.2 Past Research | 4.40 |
| 4.6.3 Study of Reinforced Beams at Treat Island | 4.41 |
| 4.6.4 Current Research at Treat Island | 4.44 |
| 4.7 Civil Engineering Laboratory, Port Hueneme, California | 4.46 |
| 4.7.1 Introduction | 4.46 |
| 4.7.2 Spherical Structure | 4.46 |
| 4.7.3 Cylindrical Structures | 4.49 |
| 4.8 Fatigue | 4.55 |
| 4.8.1 Introduction | 4.55 |
| 4.8.2 Research in the United States | 4.55 |
| 4.8.3 Research in the European Countries | 4.59 |
| 4.9 Strength | 4.61 |
| 4.9.1 Introduction | 4.61 |
| 4.9.2 Structural Lightweight Concrete | 4.64 |
| 4.9.3 Temperature Effects | 4.68 |
| 4.9.4 Impact Behavior | 4.69 |
| 4.10 Durability of Reinforced Concrete | 4.69 |
| 4.10.1 Introduction | 4.69 |
| 4.10.2 Permeability | 4.73 |
| 4.10.3 Corrosion | 4.74 |

TABLE OF CONTENTS (Cont'd.)

| <u>Section</u> | <u>Page</u> |
|---|-------------|
| 4.11 Inspection and Repair | 4.77 |
| 4.11.1 Introduction | 4.77 |
| 4.11.2 Inspection | 4.77 |
| 4.11.3 Repair | 4.79 |
| REFERENCES | 4.82 |
| 5.0 CONCLUSIONS AND RECOMMENDATIONS | 5.1 |
| 5.1 Conclusions | 5.1 |
| 5.2 Recommendations | 5.6 |
| APPENDIX A: Definitions and Nomenclature | |
| APPENDIX B: United Kingdom Science Research Council Marine Technology Program (From [4.8]) | |
| APPENDIX C: Bibliography | |

LIST OF ILLUSTRATIONS

| <u>Figure No.</u> | | <u>Page</u> |
|-------------------|---|-------------|
| 1.1 | Prestressed/Reinforced Concrete and Ferrocement Hulls Constructed Since 1950 (From [1.4]) | 1.5 |
| 2.1 | Distribution of Work in the Area of Concrete in the Marine Environment | 2.2 |
| 2.2 | Type of Organization | 2.7 |
| 2.3 | Areas of Technical Involvement | 2.7 |
| 2.4 | Materials Research on Concrete and Reinforcements | 2.8 |
| 2.5 | Materials Research Reinforced, Pretensioned, and Posttensioned Concrete | 2.9 |
| 2.6 | Deadweight Capacity (Long Tons) | 2.11 |
| 3.1 | Isometric Longitudinal Section of Dry-Cargo Hulls Built At San Francisco (From [3.6]) | 3.5 |
| 3.2 | Comparison of Complicated and Simplified Design (From [3.2]) | 3.5 |
| 3.3 | Hull Reinforcement Details (From [3.2]) | 3.7 |
| 3.4 | Reinforcing Details - National City Hulls (From [3.2]) | 3.7 |
| 3.5 | CONDEEP Platforms, Geometry and Location (From [3.10]) | 3.23 |
| 3.6 | General Features of a 3-Tower CONDEEP Platform | 3.24 |
| 3.7 | General Design Procedure (From [3.13]) | 3.26 |
| 3.8 | Star Cell Geometries (From [3.14]) | 3.29 |
| 3.9 | Slip-Forming of Cell Walls (From [3.16]) | 3.29 |
| 3.10 | Vertical Cross-Section and Horizontal Half-Section of the Ekofisk One Facility | 3.46 |
| 3.11 | Ekofisk Oil Storage Caisson Under Construction (From [3.24]) | 3.47 |
| 3.12 | Concrete Gravity Platform for Gulf of Mexico (From [3.26]) | 3.49 |
| 3.13 | Midship Section, 65,000-Ton Concrete LPG Facility (From [3.28]) | 3.50 |

LIST OF ILLUSTRATIONS (Cont'd.)

| <u>Figure No.</u> | | <u>Page</u> |
|-------------------|--|-------------|
| 3.14 | Hull Construction Scheme of Arco LPG Barge (From [3.28]) | 3.50 |
| 3.15 | Longitudinal and Transverse Sections of Genoa's Floating Dock (From [3.32]) | 3.53 |
| 3.16 | Typical Pontoon Section (From [3.35]) | 3.56 |
| 3.17 | Isometric View of Proposed Arctic Caisson (From [3.47]) | 3.70 |
| 4.1 | Graphic Representation of Cracking and Corrosion-- Beams 4 and 5 (From [4.31]) | 4.43 |
| 4.2 | Strength Increase of Concrete in Spherical Structures (From [4.33]) | 4.48 |
| 4.3 | In-Plane Cracking of Thick-Walled Negatively Buoyant Spheres (From [4.33]) | 4.48 |
| 4.4 | Compressive Strength Gain of Concrete in Different Environments (From [4.34]) | 4.50 |
| 4.5 | Total Water Intake for Spheres in the Ocean For Long Time Periods (From [4.34]) | 4.50 |
| 4.6 | Design Guide for Predicting Implosion of Concrete Cylinder (From [4.37]) | 4.52 |
| 4.7 | Relationship Between E_1 and f'_c (From [4.37]) | 4.52 |
| 4.8 | Fatigue Endurance of Concrete in Prestressed Concrete Hull (From [4.42]) | 4.57 |
| 4.9 | Fatigue Endurance of Reinforcement in Prestressed Concrete Hull (From [4.42]) | 4.57 |
| 4.10 | Reinforcing Details of Test Beam (From [4.45]) | 4.62 |
| 4.11 | Fatigue Tests Loading Arrangements (From [4.45]) | 4.62 |
| 4.12 | Fatigue Test Results on Reinforced Concrete Beam in Sea Water (From [4.45]) | 4.63 |
| 4.13 | Deterioration of a Concrete Structure in Sea Water (From [4.56]) | 4.70 |
| 4.14 | Effect of Water-Cement Ratio on Permeability (From [4.62]) | 4.75 |

LIST OF TABLES

| <u>Table No.</u> | | <u>Page</u> |
|------------------|--|-------------|
| 2.1 | Survey of Fixed Offshore Concrete Platforms, Either Installed or Under Construction in the North Sea | 2.3 |
| 3.1 | Principal Features of the U.S. Concrete Ship Program of World War II (From [3.1]) | 3.2 |
| 3.2 | Concrete Ship Program - World War II (From [3.4]) | 3.4 |
| 3.3 | Design Bending Moments (BM) and Shearing Forces (From [3.4]) | 3.10 |
| 3.4 | Allowable Unit Stresses, Psi (From [3.5]) | 3.11 |
| 3.5 | Typical Physical Properties of Lightweight Aggregates Used in U.S. Concrete Ships (From [3.16]) | 3.14 |
| 3.6 | Typical Mix Design for Concrete Used In U.S. Concrete Ships (From [3.6]) | 3.14 |
| 3.7 | Engineering Properties of Concrete Used in U.S. Concrete Ships (From [3.16]) | 3.14 |
| 3.8 | Cost Summary - Construction and Facilities (From [3.4]) | 3.19 |
| 3.9 | CONDEEP Structures (From [3.9, 3.12]) | 3.22 |
| 3.10 | Main Figures on the Construction of the TCP2 Platform (From [3.11]) | 3.33 |
| 3.11 | Mix Particulars and Compressive Strengths for Several North Sea Concrete Platforms (From [3.17]) | 3.36 |
| 3.12 | Typical Properties of Cements From Norcem (From [3.17]) | 3.38 |
| 3.13 | Assumed Wave Heights and Stress Limits, Arco Facility (From [3.28]) | 3.49 |
| 3.14 | Plant Barges (From [3.31]) | 3.59 |
| 3.15 | Comparison Between Concrete and Steel Hull Characteristics (From [3.42]) | 3.59 |
| 3.16 | Summary of Allowable Stresses (From [3.42]) | 3.62 |
| 3.17 | Static Balance Comparison of Concrete and Steel Hulls (From [3.42]) | 3.64 |

LIST OF TABLES (Cont'd.)

| <u>Table No.</u> | | <u>Page</u> |
|------------------|---|-------------|
| 3.18 | Comparison Between Deterministic Factors of Safety - Concrete Versus Steel Hulls (From [3.42]) | 3.66 |
| 3.19 | Comparison of Probabilities of Failure and Safety Indices (From [3.42]) | 3.66 |
| 3.20 | Performance in Open Water for 200,000-Ton Displacement Caisson (From [3.47]) | 3.71 |
| 3.21 | Performance in Ice-Covered Waters (From [3.47]) | 3.73 |
| 4.1 | Research in Progress as Reported by ACI Committee 115 | 4.4 |
| 4.2 | Research by Country as Reported by ACI Committee 115 (From [4.2]) | 4.4 |
| 4.3 | Research Projects Directly Applicable to Marine Concrete Structures as Reported by ACI Committee 115 | 4.5 |
| 4.4 | Research Projects Directly Applicable to Marine Concrete Structures as Reported by Concrete Laboratory, U.S. Army Waterways Experiment Station (From [4.7]) | 4.8 |
| 4.5 | Phase I of UK Concrete in the Oceans Program | 4.11 |
| 4.6 | Phase II of UK Concrete in the Oceans Program | 4.16 |
| 4.7 | Research Areas of the Cement and Concrete Association | 4.18 |
| 4.8 | Research Programs of the Cement and Concrete Association Applicable to Floating Marine Structures (From [4.11]) | 4.19 |
| 4.9 | Past and Current Netherlands Marine Technological Research in Concrete (From [4.16]) | 4.22 |
| 4.10 | Research Programs at Det Norske Veritas Applicable to Floating Marine Structures (From [4.18]) | 4.25 |
| 4.11 | Norwegian/German COSMAR Program (From [4.18]) | 4.38 |
| 4.12 | Ultimate Load Properties of Beams Tested in Flexure (From [4.31]) | 4.43 |
| 4.13 | Type of Concrete | 4.64 |
| 4.14 | Comparisons of Lightweight and Normal Weight Concrete (From [4.52]) | 4.66 |

1.0 INTRODUCTION

1.1 Overview of Program

Since 1848, when the first concrete boat was built by J. L. Lambot in France, concrete has been used sporadically for floating marine structures. Shortages of plate steel during World War I and World War II led to the construction of concrete lighters and barges, although the total number of vessels and tonnage was very small compared with steel ships. Since World War II, one primary use of concrete in the marine environment has been in the construction of oil drilling, production, and storage facilities in the North Sea area, and in LPG/LNG applications. The wide diversity in past and potential applications for both fixed and floating structures has generated a large amount of research, design, and construction.

In this country, information on the use of concrete in floating structures is scattered, and there exists no survey which gives a summary of the state of technology. Consequently, those areas of research required to extend current concrete technology to ship construction have not been identified. This report is to provide such a state-of-the-art survey so that these research areas can be identified. Current information on the use of concrete in the marine environment which is available in the open literature was reviewed. This, in conjunction with information obtained from design, construction, maintenance, certification, and research agencies, was used to provide an information base for the entire study. These results are summarized in Chapter 2.0 of this report.

Chapter 3.0 reviews in detail the design, construction, and service experience of two extensive programs on the marine use of concrete, namely, the World War II United States concrete ships and the North Sea CONDEEP platforms. This chapter also discusses other current and future applications such as ships, barges, harbor and coastal structures, and energy exploration facilities. Experience with a number of concrete ships built in the World War I and II periods is cited. It should be remembered that, because of the elapsed period and general unavailability of technical data, it is difficult to correlate this experience with the design criteria, construction procedures, or service history of these ships.

Chapter 4.0 summarizes past and current research activities applicable to floating marine structures. This chapter, along with the information gathered as part of the review of past, current, and future applications, forms the basis for recommending a research plan for future Ship Structure Committee activity. These recommendations are given in Chapter 5.0.

Appendix A contains a list of technical terms and definitions applicable to this report, Appendix B describes applicable research in concrete being performed in the United Kingdom Science Research Council Marine Technology Program, and Appendix C is the bibliography compiled as part of the information survey.

1" TO BIND

1.2 Brief History of Reinforced Concrete in Floating Marine Structures

Concrete is one of the oldest man-made building materials. Excavations in the Mediterranean area indicate that concrete made from natural pozzolanic cement has been used for over 2,000 years in structures, many of which were exposed to seawater. The development of portland cement, first patented in England in 1824, was essential for the continued development of concrete structures. The development of reinforced concrete followed, with its invention generally attributed to Joseph Lambot, a Frenchman, who applied reinforced concrete to the fabrication of a small ferrocement boat. He built his first small rowboat in 1848 and later exhibited a similar boat at the Paris Exposition of 1855. Ferrocement was also used by other builders in Europe and America during the late 1800's and early 1900's. The sloop *Zeemeeuw*, built in 1887 by Gabellini and Boon, was finally taken out of service in 1968 [1.1].[†] The *Concrete*, constructed in the early 1900's, was the first ferrocement vessel used by the United States government. The 5.5-m (18-ft) long boat had a hull thickness of 19 mm (3/4 in.) and was capable of 10 knots service on the Great Lakes [1.2]. Since 1848, a large number of ferrocement vessels have been constructed and have performed satisfactorily [1.3, 1.4].

The first examples of the use of the more conventional cast-in-place, bar-reinforced concrete were several barges built in Italy by Gabellini. A 50-ton lighter built in 1902 and the 150-ton *Liguria*, which was in service from 1905 to 1917, are typical. N. K. Foagne, of Norway, built the first large seagoing vessel, the *Namsenfjord*, a 25.5-m (84-ft) long ship launched in 1917 [1.1]. Searle [1.5] refers to a number of concrete pontoons and barges constructed during the period leading up to the first world war.

During World War I, the United States, the United Kingdom, and the Scandanavian countries built a number of reinforced concrete vessels. These vessels copied the traditional framing of steel ships of the period and therefore were grossly overdesigned and overweight. The largest cast reinforced ship, the *Selma*, was built in the United States in 1919. After only a few years' service, this 6340-ton, 130-m (434-ft) long ship was scuttled in the shallow water of Galveston Bay. A study of her hull in 1953 showed little deterioration of the concrete [1.1]. The majority of ships and barges built during this period survived well with one notable exception, the *Armistace*, built in Great Britain in 1919 [1.1]. When surveyed in 1968, the hull was found to be badly spalled and the internal frames almost completely devoid of concrete. The primary reason was the poor quality of concrete used during the construction of this vessel.

Overall, about 85,000 tons of seagoing shipping were built during World War I, not counting several hundred barges, lighters, pontoons,

[†]Numbers in brackets denote references listed at the end of each chapter.

and a few floating docks. Various construction procedures were used for these vessels, including guniting, slip-forming, and prefabrication. Concrete shipbuilding programs came to a halt following World War I because of a surplus of merchant ship tonnage. No new major construction was undertaken until World War II.

The second world war once again created a need for more shipping. To partially satisfy this need, concrete was again used because of the scarcity of steel plating. The majority of construction was performed in the United States, with efforts concentrated in the area of towed vessels, although 24 self-propelled cargo ships were constructed. One hundred four seagoing vessels were constructed in the United States, with a total of 488,000 total deadweight tons. The first prestressed concrete vessels built in the United States were a landing craft and a barge. Precast cells were laid in a checkerboard fashion with the prestressing steel placed between the cells. After tensioning, the steel was covered with a layer of gunite concrete [1.6]. During the same period, Germany constructed several 500-ton prestressed barges. The flat portions of the bottom and sides were cast on the ground with pretensioned reinforcement. The sides were then bent up, and the joints, stem, and stern were cast in place. Construction of reinforced concrete vessels was also carried out in Britain and the USSR.

Following World War II, construction of concrete vessels again declined. Nervi, in Italy, constructed a number of ferrocement vessels during the period immediately following the war. The *Nennelle*, a 12.5-m (41-ft) long ketch, had a shell thickness of only 12 mm (1/2 in.). This ketch, built in 1948, is still in excellent condition [1.1]. Since that time, a large number of ferrocement boats have been built, mainly by do-it-yourself yachtsmen. Recently, ferrocement construction techniques have been used in underdeveloped countries for the production of barges, pontoons, boats, and buoys [1.7, 1.8].

Reinforced concrete, as distinct from ferrocement, has not been used extensively since World War II [1.7]. Barges have been built for use in the Gulf of Mexico, as well as pontoons and floating docks in other parts of the world. Reinforced concrete has been used only where the additional weight over that of steel structures is not important.

Since World War II, development has been primarily in the area of prestressed concrete vessels. Early examples are the cellular pontoons built for Le Havre Harbor in 1951 and a posttensioned pontoon 55 m long by 24 m wide by 5.35 m deep (180 ft x 78 ft x 17 ft) constructed in Belgium to carry a small oil refinery in Libya [1.1]. Alfred Yee designed, to American Bureau of Shipping (ABS) standards, and patented a 2000-ton capacity barge to carry either dry cargo or petroleum products. Typical dimensions are:

| | |
|----------------|---------------|
| Length overall | 60 m (198 ft) |
| Beam | 17 m (57 ft) |
| Depth | 4 m (13 ft) |

Nineteen of these barges were built between 1964 and 1966, and they have provided good service at low annual maintenance cost [1.9]. Additional prestressed concrete barges were built in New Zealand in 1969 for service in the South Pacific. Marine Concrete Structures, New Orleans, has constructed over 400 concrete barges and platforms with a wide variety of superstructure amounted plants. More recently, in 1976, a precast/prestressed concrete floating platform was constructed in Washington and towed to the Java Sea [1.6]. The structure, 140 m long, 41.5 m wide, and 17.1 m deep (461 ft x 136 ft x 57 ft), was designed by ABAM Engineers, Inc., and constructed by Concrete Technology Corporation. The vessel, designed as a permanently moored facility for storage and processing of LPG, is posttensioned both transversely and longitudinally. Design and construction of the vessel were carried out under ABS rules. D

Figure 1.1 presents results from a recent survey by Harrington and Harrison [1.4] on barge and pontoon prestressed, reinforced, and ferrocement hulls constructed since 1950. The ferrocement hulls are small, usually less than 27.5 m (90 ft) in length. For the remaining structures, the prestressed exceed the reinforced hulls by a ratio of over two-to-one. The 137.5-142.5-m length class contains the prestressed floating LPG facility for the Java Sea mentioned in the previous paragraph and two floating reinforced concrete ship repair docks in the USSR.

Concrete floating bridges are another use of concrete in the marine environment. Three precast concrete multi-pontoon structures built in 1939, 1955, and 1962 have been in service in the Seattle, Washington, area. The precast pontoons, 101 m long, 20 m wide, and 4.8 m deep (360 ft x 66 ft x 15 ft 8 in.), were launched following construction in a graving dock. After the superstructure was constructed, the pontoons were towed to the bridge site and posttensioned together. The first two bridges built in 1939 and 1945 have provided good service, while the third bridge, built in 1962, failed in 1979 [1.10]. The finding of the survey team was that failure was produced by a combination of a very severe storm (producing dynamic response and movement of the anchors, flooding of the pontoons), and deterioration of strength due to corrosion.

More recent developments in the use of concrete in the marine environment have been primarily associated with fixed structures used for oil production and storage facilities. These fixed structures will be discussed in more detail later in this report.

The purpose of this brief historical review has been to demonstrate the variety of applications for concrete in the marine environment over the last 130 years. With few exceptions, the concrete structures have performed well under the loads of the marine environment. Durability,

486-328

(17)

1.5

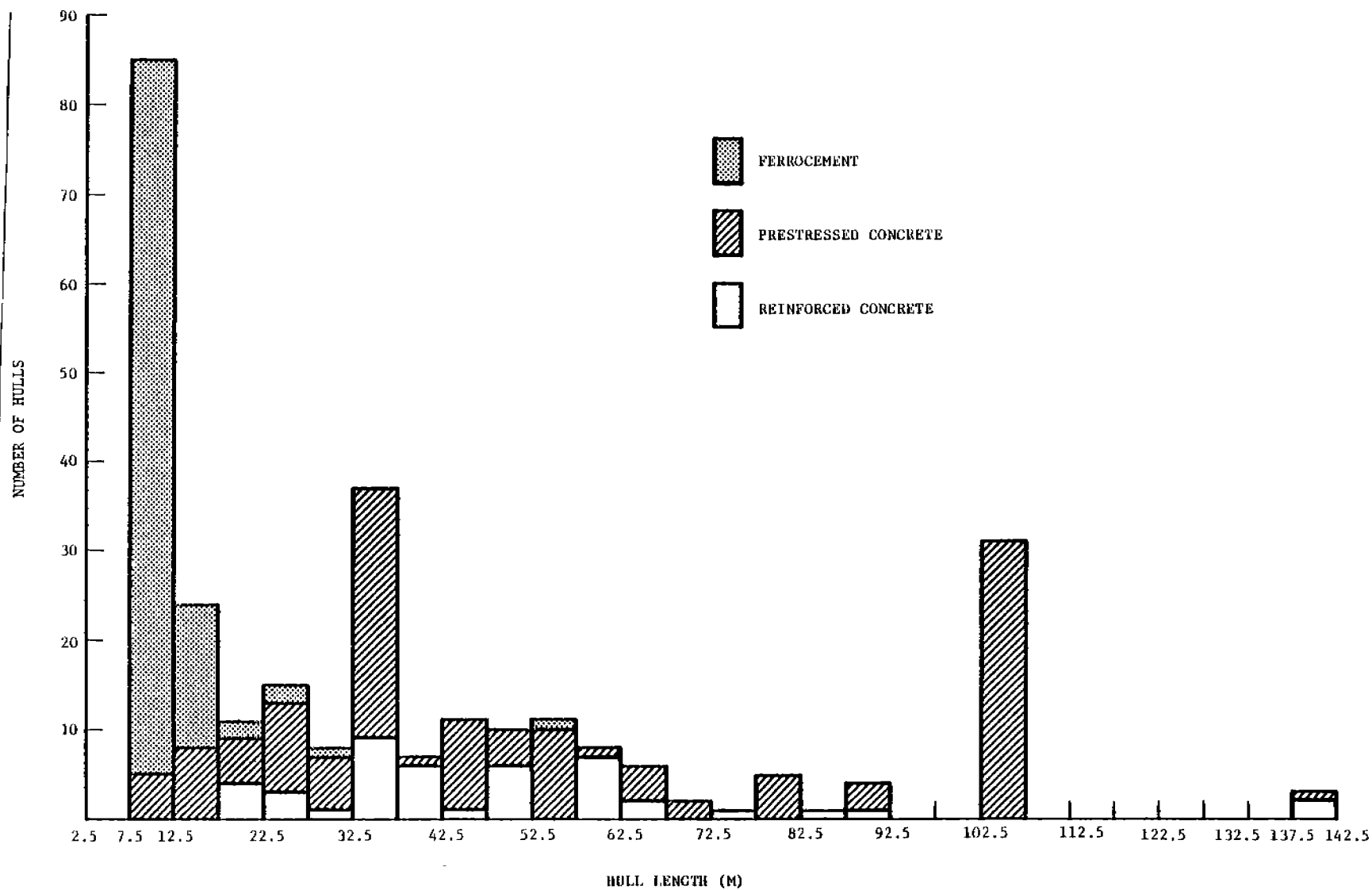

FIGURE 1.1 PRESTRESSED/REINFORCED CONCRETE AND FERROCEMENT HULLS
CONSTRUCTED SINCE 1950 (FROM [1.4])

(17)

watertightness, vibration control, seaworthiness, and material strengths and weaknesses have been demonstrated. Future advances in the use of concrete will require improvements in design and analysis methods, material properties, maintenance techniques, and construction procedures. These technical advances are, of course, directly coupled to the economic feasibility of using concrete in floating marine structures. Areas requiring further study and research must be based on both past history and expected future applications. The remainder of this report will look at these areas in more detail.

REFERENCES

- 1.1 Morgan, R.G., "History of and Experience with Concrete Ships," Conference on Concrete Ships and Floating Structures, pp 3-16, Berkeley, California, Sept. 1975.
- 1.2 Liu, T.C., and McDonald, J.E., "Concrete Ships and Vessels ~ Past, Present, and Future," Concrete Laboratory, U.S. Army Engineers Waterways Experiment Station, Misc. Paper C-77-12, Vicksburg, Mississippi, Oct. 1977.
- 1.3 Morgan, R.G., "Development of the Concrete Hulls," Concrete Afloat, The Concrete Society, London, 1977.
- 1.4 Harrington, K.E., and Harrison, R., "Survey of the Operational Experience Achieved with Prestressed Concrete/Reinforced Concrete and Ferrocement Barge and Pontoon Hulls Since 1950," Sunderland Polytechnic, March 1981.
- 1.5 Searle, A.B., "Reinforced Concrete Ships, Barges and pontoons," Concrete and Constructional Engineering, London, Supplement, Part I, Nov. 1918; Part II, Dec. 1918.
- 1.6 Anderson, A.R., "Prestressed Concrete Floating Structures (State-of-the-Art)," SNAME Spring Meeting, pp 123-144, Vancouver, B.C., May 1975.
- 1.7 Curry, R., "Concrete as a Ship and Boatbuilding Material," Symposium on Indian Shipbuilding, Calcutta, India, Feb. 1980.
- 1.8 Gopalaratram, V.S., Pama, R.P., and Valls, J., "A Review of Marine Applications of Ferrocement in Asia," Concrete Ships and Floating Structures Convention, Rotterdam, Nov. 1979.
- 1.9 Sare, P.M., and Yee, A.A., "Operational Experience with Prestressed Concrete Barges," Concrete Afloat, London, 1977.
- 1.10 "Hood Canal Floating Bridge, Phase 1 Report, Determination of the Cause of Failure," for State of Washington, Department of Transportation, Tokola Offshore and Earl and Wright Consulting Engineers, Aug. 1979.

2.0 STATE-OF-THE-ART REVIEW

2.1 Overview

Developments in the use of concrete in the marine environment have been spread throughout the world. Figure 2.1 gives an indication of the diversity of countries and their areas of involvement in this technology.

Exploration of the North Sea oil reserves has prompted the design and installation of large-scale concrete structures to withstand severe environmental conditions. Table 2.1 shows the various structures installed or under construction. The severe environment and unique design requirements of these structures have led to a large amount of research in the use of concrete in the marine environment. Classification and regulatory agencies in Europe have anticipated and responded to the expanded use of concrete in both fixed and floating structures by developing codes and regulations. For example, Det norske Veritas (DnV) [2.1, 2.2], Norwegian Standards Federation [2.3], United Kingdom Department of Energy (UKDOE) [2.4], Fédération Internationale de la Précontrainte (FIP) [2.5], and Bureau Veritas (BV) [2.6, 2.7] have rules concerning design, construction, and inspection of marine concrete structures.

As mentioned in the first chapter, during the two World Wars the United States constructed the largest number of oceangoing concrete vessels. Construction of concrete marine structures after World War II has been limited. Exceptions are the concrete barges and platforms for the Gulf of Mexico, the ARCO LPG processing plant, the floating bridges in Washington State, and the barges designed for use in the Philippines. Recently the American Concrete Institute (ACI) has published guidelines for the design and construction of fixed offshore concrete structures [2.8]. Much of the information was drawn from sources such as the American Petroleum Institute's (API) [2.9] recommended practice for fixed offshore steel platforms, and European guidelines [2.1] and [2.5]. The ACI document contains chapters on materials and durability, loads, design and analysis, foundations, construction and installation, inspection and repair, and appendices on environmental loads and design for earthquakes. The American Bureau of Shipping (ABS) has also been active in developing analysis procedures [2.10] and rules for building and classifying concrete vessels. A draft of these rules is complete and is currently being reviewed internally at ABS [2.11].

Since World War II, the USSR has published little in the open literature on the use of concrete for marine vessels. Work by Bezukladov [2.12] in the area of ship hull design and construction seems to be the most significant. Harrington and Harrison [2.13], in addition to the floating reinforced concrete ship repair docks mentioned in Chapter 1.0,

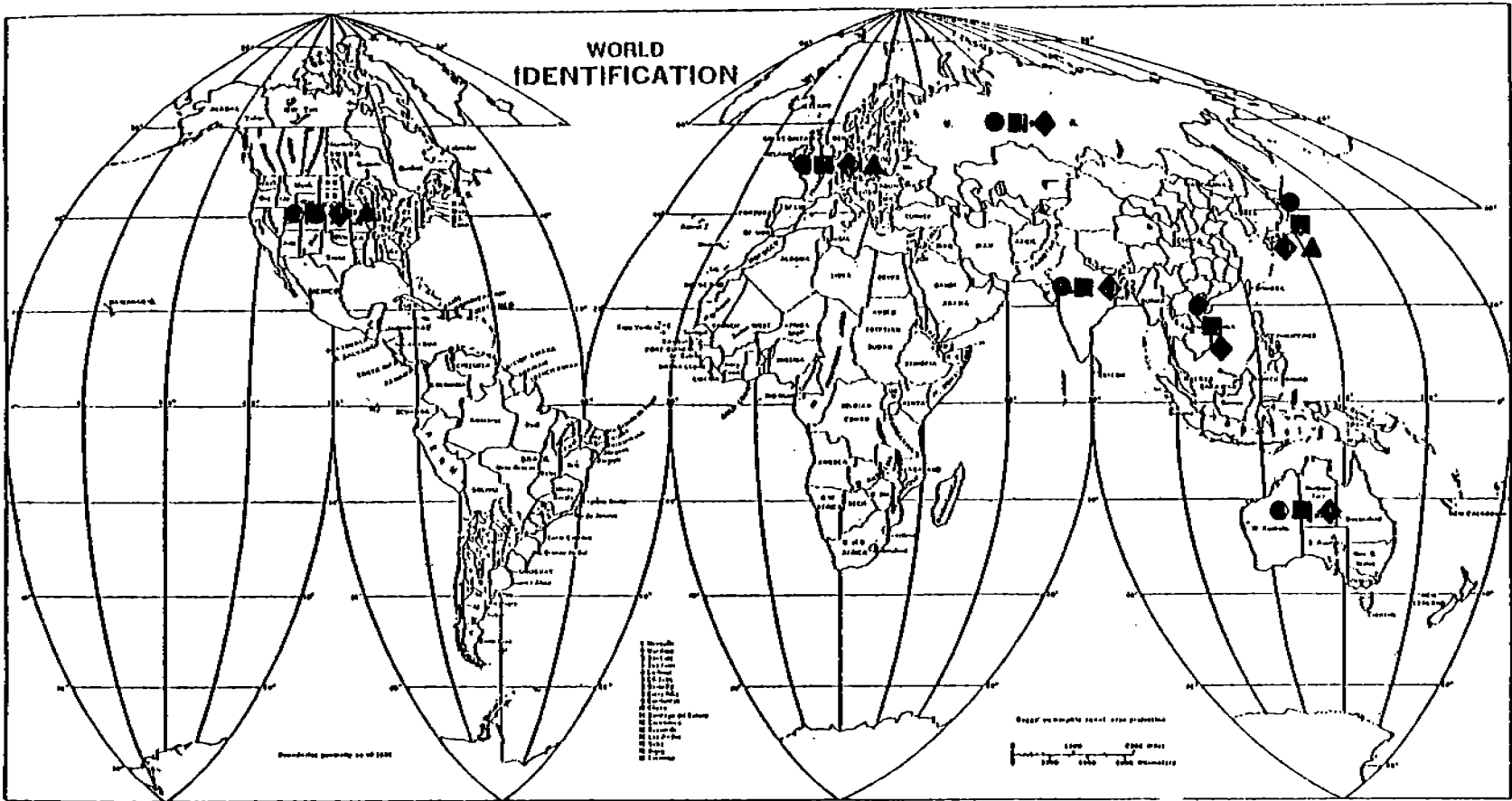

- Design ●
- Construction ■
- Research ◆
- Certification ▲

FIGURE 2.1 DISTRIBUTION OF WORK IN THE AREA OF CONCRETE
IN THE MARINE ENVIRONMENT

TABLE 2.1 SURVEY OF FIXED OFFSHORE CONCRETE PLATFORMS,
EITHER INSTALLED OR UNDER CONSTRUCTION IN THE NORTH SEA

| Type of Design Location | Main Function | Design Wave Height (m) | Water Depth (m) | Approx. Concrete Volume (m ³) | Base Diameter (m) | Storage Capacity (mill. barr.) | Installation Year |
|-----------------------------|------------------------------------|------------------------|-----------------|---|-------------------|--------------------------------|-------------------|
| 1 DORIS EXOFISK 1 (N) | Storage | 24.0 | 70 | 90,000 | 92 | 1.0 | 1973 |
| 2 CONDEEP BERYL A(UK) | Drilling, production, storage | 29.5 | 120 | 55,000 | 100 | 0.93 | 1975 |
| 3 CONDEEP BRENT B (UK) | Drilling, production, storage | 30.5 | 142 | 65,000 | 100 | 1.0 | 1975 |
| 4 DORIS FRIGG CDPI(UK) | Drilling, Compression, production | 29.0 | 96 | 60,000 | 101 | - | 1975 |
| 5 SEA TANK BRENT C (UK) | Drilling, production, storage | 30.5 | 142 | 105,000 | 100 | 0.65 | 1978 |
| 6 SEA TANK FRIGG TPI (UK) | Production | 29.0 | 104 | 70,000 | 72 | - | 1976 |
| 7 SEA TANK CORMORANT A (UK) | Drilling, production, storage | 30.5 | 152 | 115,000 | 100 | 1.0 | 1978 |
| 8 CONDEEP BRENT D (UK) | Drilling, Production, storage | 30.5 | 142 | 65,000 | 100 | 1.0 | 1976 |
| 9 ANDOC DUNLIN A (UK) | Drilling, Production, storage | 30.5 | 152 | 89,000 | 104 | 0.85 | 1977 |
| 10 CONDEEP STATFJORD A(N) | Drilling, production, storage | 30.5 | 149 | 88,000 | 110 | 1.3 | 1977 |
| 11 CONDEEP FRIGG TCP2 (N) | Treatment, compression, production | 29.0 | 104 | 50,000 | 100 | - | 1977 |
| 12 DORIS FRIGG MP2 (UK) | Compression station | 29.0 | 94 | 60,000 | 101 | - | 1976 |
| 13 DORIS MINIAN (UK) | Drilling and production | 31.2 | 139 | 142,000 | 140 | - | 1978 |
| 14 PUB 3 PETROBRAS | Drilling, production, storage | 11.0 | 15 | 15,000 | 50 | 0.125 | 1977 |
| 15 PUB 2 PETROBRAS | Drilling, production, storage | 11.0 | 15 | 15,000 | 50 | 0.125 | 1978 |
| 16 FAG 2 PETROBRAS | Drilling, production, storage | 11.0 | 15 | 15,000 | 50 | 0.125 | 1978 |
| 17 CONDEEP STATFJORD B(N) | Drilling, production, storage | 32.0 | 149 | 135,000 | 169 | 2.0 | 1981 |

N = Norway
UK = United Kingdom

list six reinforced concrete, permanently moored floating hulls between 20 m (65 ft) and 77 m (250 ft) long and four free-floating prestressed concrete hulls in the 23-m (75-ft) to 65-m (210-ft) length class built in the USSR after 1950.

In Asia the primary work has been in the development of ferrocement pontoons, buoys, and boats. For the underdeveloped countries in this region, the low-technology, labor-intensive techniques of ferrocement construction are very applicable.

Japan is also involved in the development of ferrocement techniques for small craft. They have also built several experimental prestressed concrete barges 10 m (33 ft) to 24 m (78 ft) in length, of which at least two have been classified by the Japanese ship classification society, Nippon Kaiji Kyokai [2.14, 2.15]. In addition, the design and construction of several harbor and coastal structures have been undertaken in prestressed concrete. An example is the Tomakomai industrial development project in Japan [2.16].

The offshore coal-loading terminal completed in 1975 at Hay Point, Queensland, Australia, is an example of a major floating concrete structure the Australians have designed and constructed [2.17]. The terminal, constructed 2000 m (6500 ft) from shore, using 10 prestressed concrete caissons, provides a berth for 120,000 dwt ships. A large number of ferrocement sailing vessels have been constructed in Australia, and ideas have been developed for large floating plant facilities [2.18].

This section and Chapter 1.0 give an indication of the range of interest and experience in both fixed and floating concrete structures throughout the world. Since this study is primarily a state-of-the-art review, it is necessary for the information to be as up-to-date as possible, and several types of sources were used. The first was the open literature, including reports, papers, and proceedings of conferences concerned with use of concrete in the marine environment. Inquiries were made to organizations and individuals currently involved with this technology to obtain the most recent or unpublished information. In addition, personal contact with a number of individuals in the United States and Europe was established. The following sections in this chapter describe the information sources and discuss the findings from this review.

2.2 Major Information Sources

The first attempt to categorize the current literature was a computerized literature review of the Lockheed Information System DIALOG data base. In this data base, the Computerized Engineering Index, the Information Service in Mechanical Engineering, and the Government Reports Announcement were searched. In addition, the Maritime Research Information Service data base was automatically scanned. Concurrent with the automated literature search, a search of the SwRI library was made of the proceedings and journals of various technical societies such as the American Society

of Civil Engineers (ASCE), American Concrete Institute (ACI), and the Society of Naval Architects and Marine Engineers (SNAME). From this search, technical conferences directly applicable to floating concrete structures were identified. These included:

Offshore Technology Conference

- 1969-1981 (Yearly)
Houston, Texas

Fédération Internationale de la Précontrainte (FIP) Congress

- 6th, 1970
Prague, Czechoslovakia
- 7th, 1974
New York, New York
- 8th, 1978
London, England

Gastech - The International LNG/LPG Conference and Exhibition

- 1974-1981 (Yearly)

Conference on Concrete Ships and Floating Structures

Continuing Education in Engineering,
University of California Extension

- September 15-19, 1975
Berkeley, California

Design and Construction of Offshore Structures

Conference of Institution of Civil Engineers

- October 27-28, 1976
London, England

Conference on Behavior of Offshore Structures (BOSS)

- BOSS '76
August 2-5, 1976
Trondheim, Norway
- BOSS '79
August 28-31, 1979
London, England

Concrete Afloat

- March 3-4, 1977
London, England

Brasil Offshore '79

- October 8-12, 1979
Rio de Janeiro, Brasil

Concrete Ships and Floating Structures Convention

- November 12-14, 1979
Rotterdam, Holland

International Conference on Performance of Concrete
in Marine Environment

- August 17-22, 1980
New Brunswick, Canada

International Colloquium on the Strength
of Concrete in the Ocean

o October 8-10, 1980
Brest, France

Floating Plants, 1st International Conference

o October 13-15, 1980
Paris, France

From this literature review, organizations and individuals working in the areas of concrete applications, design, materials research, construction inspection, and maintenance were identified. To obtain the most current state-of-the-art information, over 160 individuals were contacted by mail in the following countries: Australia, Belgium, Canada, Denmark, Finland, France, West Germany, Italy, Japan, Netherlands, Norway, Sweden, Venezuela, Yugoslavia, the United Kingdom, and the United States. Forty-one percent of those contacted responded; an additional 19 percent of the individuals contacted indicated they were no longer active in the concrete technology field or were unable to respond because of the proprietary nature of their work.

A summary of the findings from this survey is presented in Figures 2.2 to 2.5. The ordinate of each graph shows the percentage of organizations* which indicated involvement or interest in a given area. Responses could have been given in more than one category, so that the total does not necessarily equal 100 percent. Only trends, and not absolute quantities, should be interpreted from these results due to the limited number (67) of responses.

In Figure 2.2 the responding organizations were divided into three major geographical groupings according to their area of technical involvement. The first, including the USA and Canada, accounted for 46 percent of the responses. Thirty-seven percent were from the West European community. The third group, with 17 percent of the responses, represented Australia and Japan.

Of the individuals responding, Figures 2.2 and 2.3 indicate the greatest number are associated with research type organizations involved in materials research and testing. The second largest group consists of those involved in design, consulting, and construction. Individuals active in certification, operation, inspection, maintenance, and repair of these structures form the majority of the remaining responses. This distribution is consistent with the open literature where the majority of articles are concerned with materials research, testing, and design.

Only a limited number of papers are available in the area of construction and maintenance. This is not to say that the state-of-the-art in these areas is not as developed as in the material and design areas,

*In this section the terms organization and individual are synonymous.

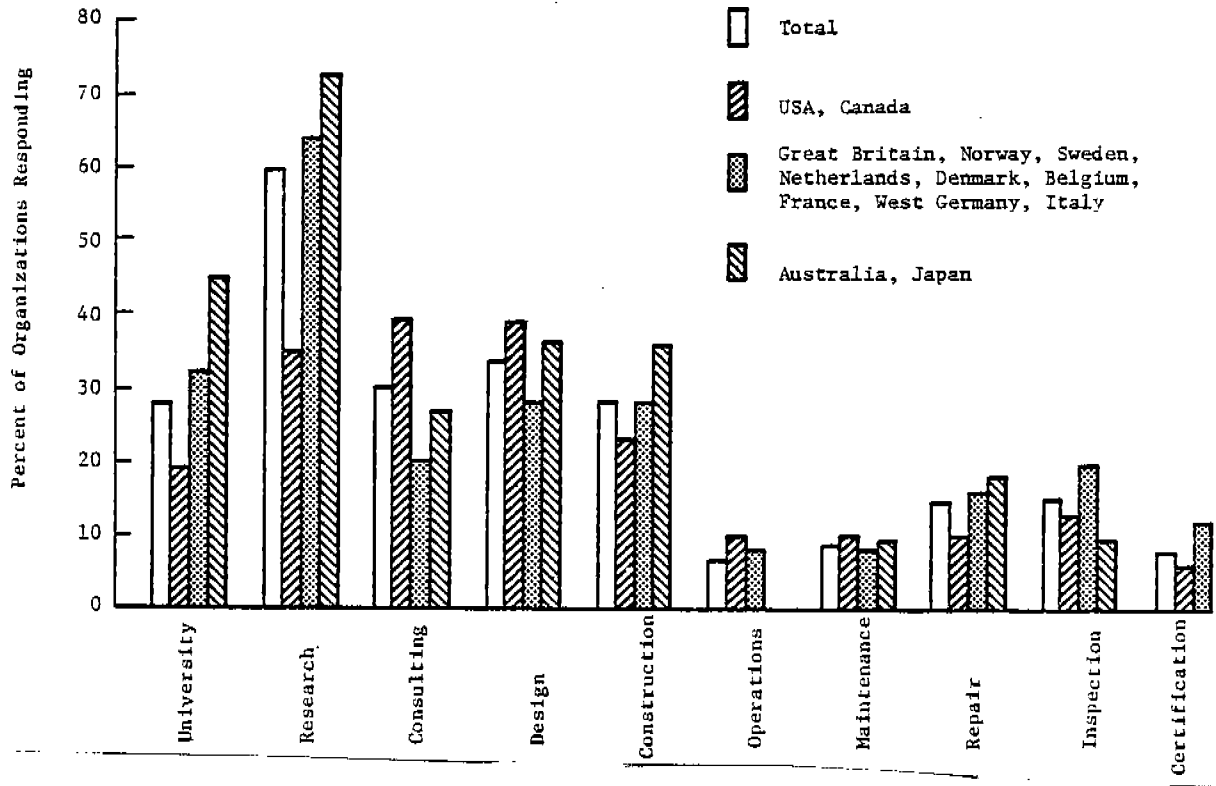

FIGURE 2.2 TYPE OF ORGANIZATION

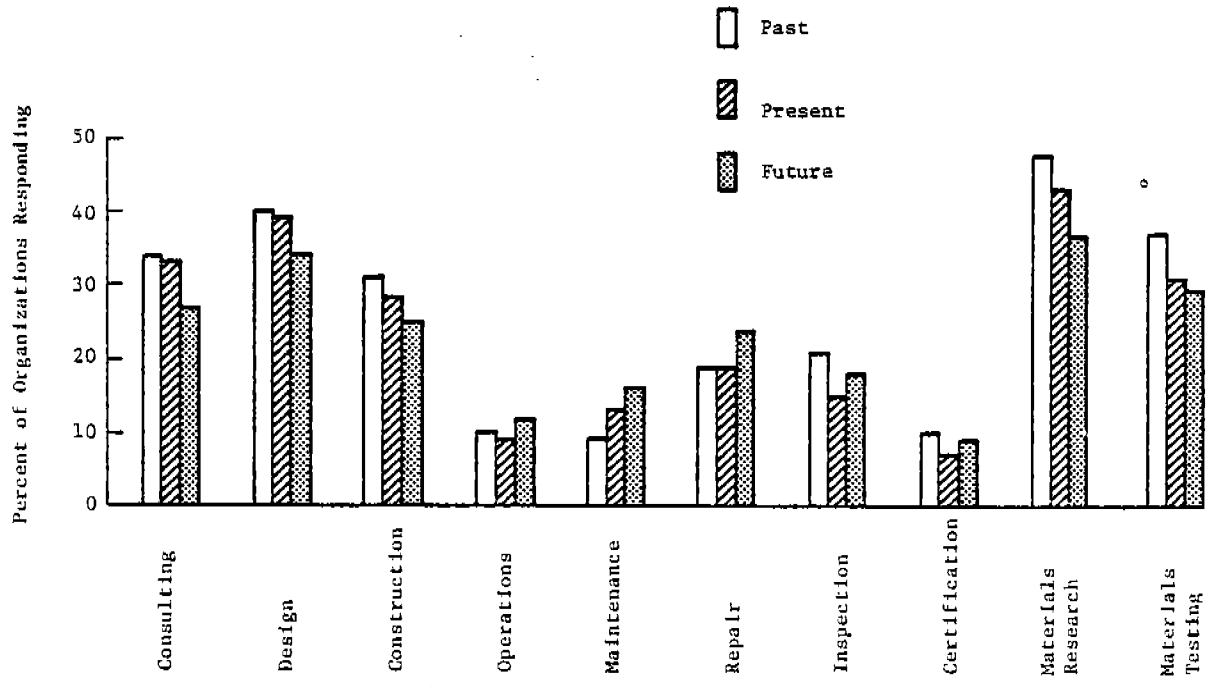

FIGURE 2.3 AREAS OF TECHNICAL INVOLVEMENT

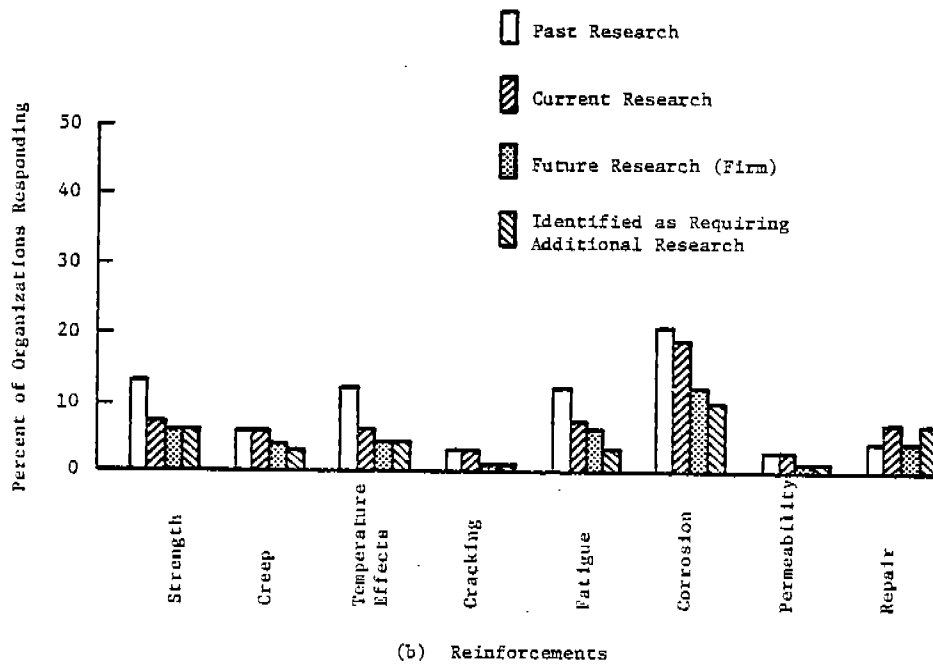
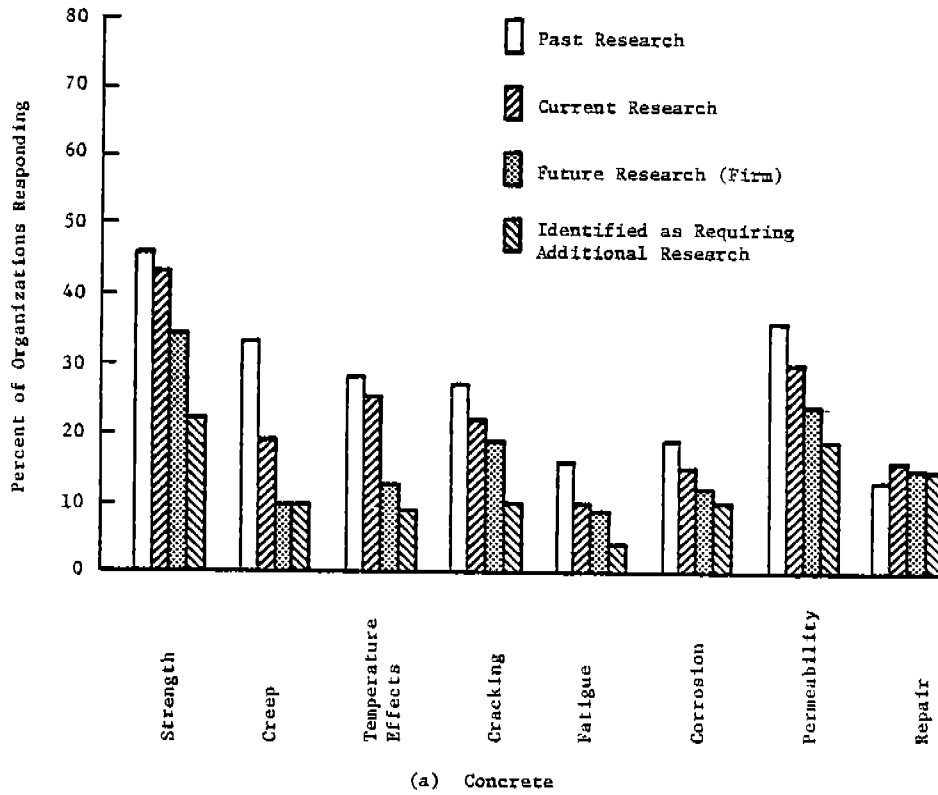
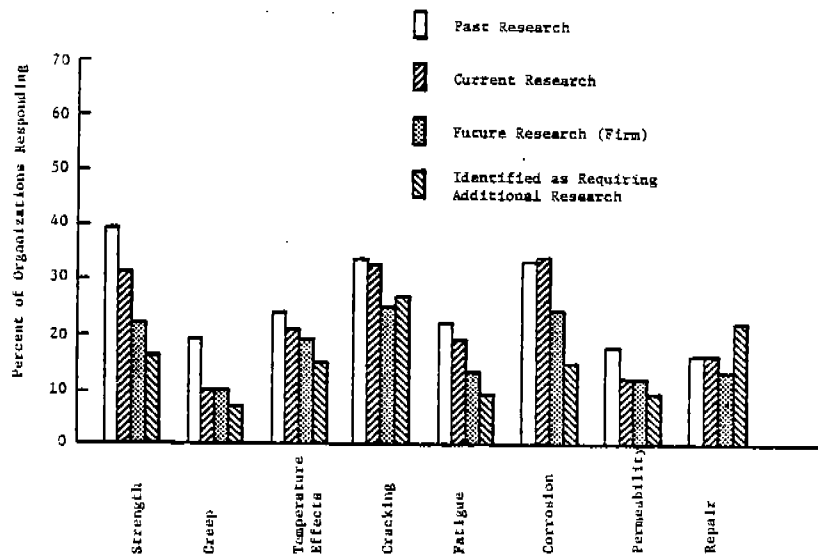
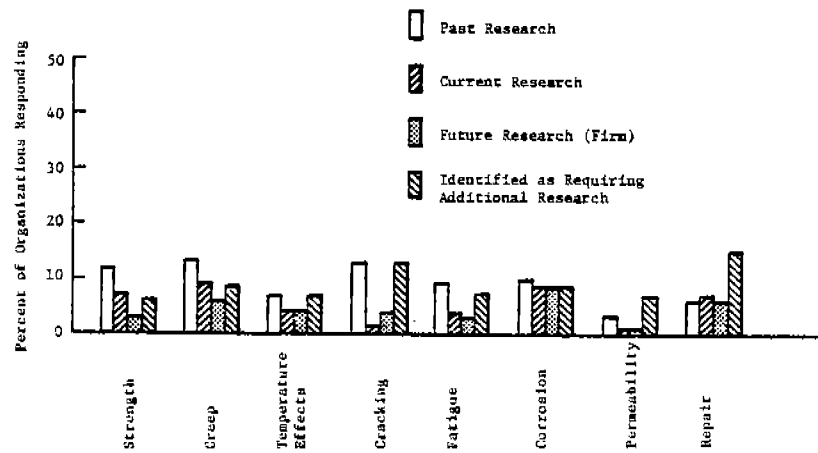

FIGURE 2.4 MATERIALS RESEARCH ON CONCRETE AND REINFORCEMENTS



(a) Reinforced Concrete



(b) Pre-Tensioned Concrete

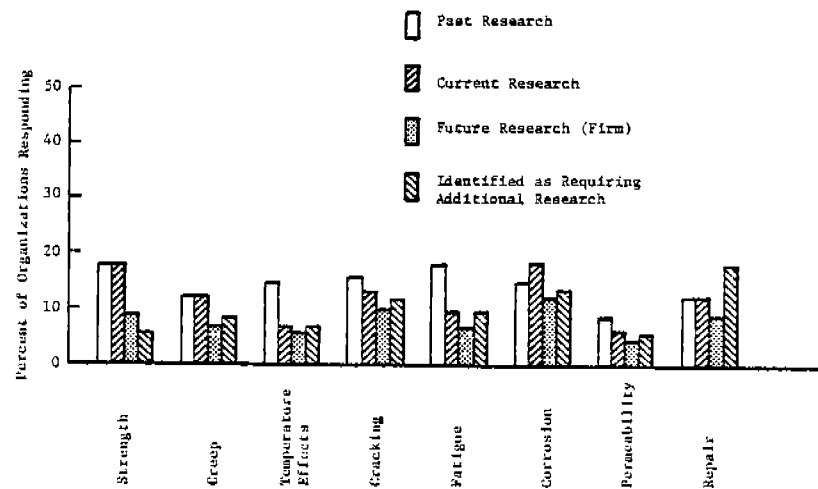

(c) Post-Tensioned Concrete

FIGURE 2.5 MATERIALS RESEARCH ON REINFORCED, PRETENSIONED, AND POSTTENSIONED CONCRETE

but that publications are limited. In fact, current practices in slip-forming and precast construction are extremely sophisticated and efficient.

It is interesting to note from Figure 2.3 that while the fields of materials, consulting, design, and construction show the largest activity, present and future interest in these areas is declining. On the other hand, the other fields, such as maintenance, repair, and inspection, show the opposite trend -- low starting base, but increasing interest.

Figure 2.4 summarizes the responses for the individual materials constituting a concrete structural system, namely, plain concrete and reinforcements. Certainly concrete has received the greatest amount of attention, and interest in most technical fields is remaining level or declining, probably because of the great amount of past work. The exception is in the area of repair, where activity and interest are increasing.

Figure 2.5 is revealing in that it gives the respondees' views of materials research in the areas of reinforced, pretensioned, and posttensioned concrete. Certainly the greatest activity has been in reinforced concrete. Temperature effects include both high and low temperature characteristics. Interest in cracking, corrosion, and permeability has been significant because of the requirement to provide a permanent barrier both for internal storage and to keep sea water out. Interest in fatigue has been stimulated by the repeated loadings encountered under wave action, and the long service life requirements have dictated the use of design procedures incorporating fatigue procedures.

However, research interest in reinforced concrete for floating marine structures (Figure 2.5(a)) seems to be declining, with the exception of cracking, permeability, and repair, which are remaining about level. Since more and more concrete structures are being built, the interest in repair techniques should continue.

Pre and posttensioned concrete, on the other hand (Figure 2.5(a & b)), show less past and current research activity, but a projected increase of interest in almost all fields. This trend probably reflects the realization that if concrete is to be used in ships or barges for material transport, then the total hull weight must be reduced. This would increase the deadweight/displacement ratio towards that of an all-steel vessel. Since the deadweight/displacement ratio is a measure of how efficiently a ship can transport cargo, the problem of hull weight must be overcome if concrete is to compete successfully with steel. For example, the reinforced concrete hulls built during both World Wars have a legacy of being overweight. No improvements were made in this area during the 20-year period between World Wars I and II despite experience with land-based structures, higher allowable concrete and steel stresses, and construction techniques. The weight problem is clearly illustrated in Figure 2.6, where the deadweight/displacement ratio is plotted against deadweight capacity for several classes of steel vessels and the World War I and II concrete ships. Although the ARCO prestressed concrete barge is not used for LPG transport, it is shown for comparison purposes.

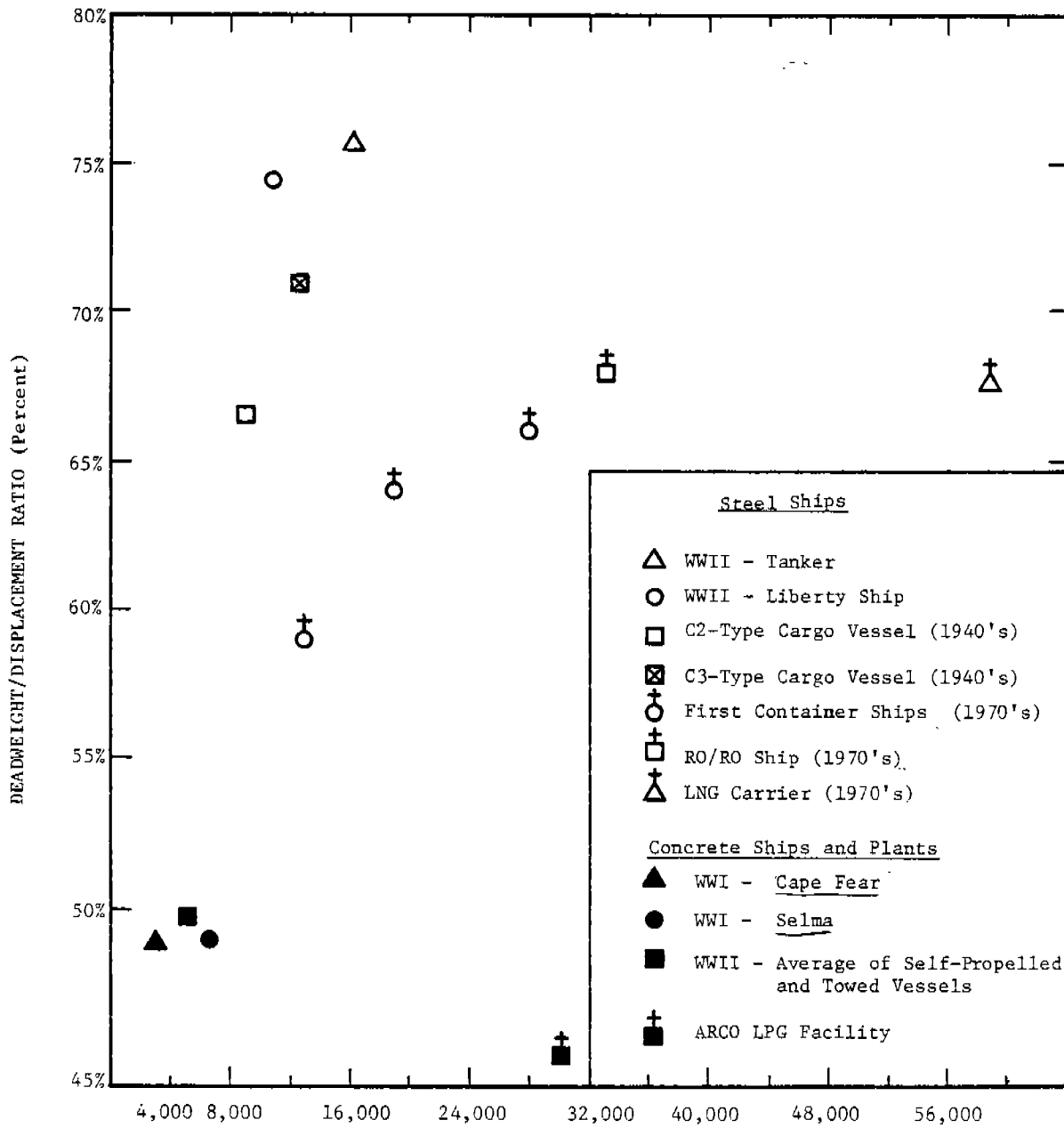

FIGURE 2.6 DEADWEIGHT CAPACITY (LONG TONS)

29

Prestressing and posttensioning are certainly techniques of utilizing concrete and reinforcements more efficiently by introducing initial compressive loads so that the net working stresses remain essentially in compression. Hence, the tensile loads which cause cracks are avoided.

In addition to the responses received by mail, the project investigators had the opportunity to make followup inquiries by telephone and personal visits. For example, organizations involved in materials research, design, testing, and certification were visited in the Netherlands, France, Norway, Scotland, and England. These visits provided the opportunity for direct dialogue with the European researchers concerning the use of concrete in floating marine structures and a chance to learn firsthand about many ongoing projects. This research work, as well as activities conducted in the United States, will be reviewed in Chapter 4.0.

REFERENCES

- 2.1 "Rules for the Design, Construction and Inspection of Offshore Structures," Det norske Veritas, Høvik, Norway, 1977.
- 2.2 "Guidelines for the Design, Construction and Classification of Floating Concrete Structures," Det norske Veritas, Høvik, Norway, 1978.
- 2.3 "Norwegian Code of Practice for Concrete Structures, Computation and Design," Norwegian Standards Federation, NS3473, Norway, 1978.
- 2.4 "Offshore Installation: Guidance on Design and Construction," U.K. Department of Energy, 1977.
- 2.5 "Recommendation for the Design and Construction of Concrete Sea Structures," FIP, 3rd Edition, FIP/6/1, Cement and Concrete Association, Wexham Springs, Slough, England, July 1977.
- 2.6 "Rules and Regulations for the Construction and Classification of Offshore Platforms," Bureau Veritas, Paris, France, 1975.
- 2.7 "Classification and Survey of Concrete Ships and Pontoons," Bureau Veritas, Guidance Note NI 175 CN4, Paris, France, 1979.
- 2.8 "Guide for the Design and Construction of Fixed Offshore Concrete Structures," ACI Report of Committee 357, ACI Journal, Dec. 1978.
- 2.9 "API Recommended Practice for Planning, Designing, and Constructing Fixed Offshore Platforms," API RP 2A, 9th Edition, American Petroleum Institute, 1977.

- 2.10 Curry, R., "Proposed Method of Analysis of Prestressed Concrete Vessels (Pretensioned Strands)," American Bureau of Shipping, 1967; Revised, 1975, 1977, and 1979.
- 2.11 Private Communications with Mr. Robert Curry, American Bureau of Shipping, New York, November 1981.
- 2.12 Bezukladov, V.F., Amelyanovich, K.K., Verbituky, V.D., and Bogoyavlenski, L.P., "Reinforced Concrete Ship Hulls: Design, Strength and Construction Technology," Shipbuilding Publishing House, Leningrad, 1968, NTIS Defense Document Center AD0680042.
- 2.13 Harrington, K.E., and Harrison, R., "Survey of the Operational Experience Achieved with Prestressed Concrete/Reinforced Concrete and Ferrocement Barge and Pontoon Hull Since 1950," Sunderland Polytechnic, March 1981.
- 2.14 "Provisional Rules for Prestressed Concrete Barges," Nippon Kaiji Kyokai, Japan.
- 2.15 Emi, H., Kobayashi, R., and Noguchi, K., "Study of the Structural Design Method of Concrete Barge," International Symposium on Offshore Structures, Brasil Offshore, Rio de Janeiro, October 1979.
- 2.16 Oda, T., "Outline of the East Tomakomai Industrial Development Project," Civil Engineering in Japan, Circa 1979.
- 2.17 Eddie, A.G.F., "Lessons Learned From Two Major Floating Concrete Structures Projects in Australia," Concrete Ships and Floating Structures Convention, Rotterdam, Nov. 1979.
- 2.18 Eddie, A.G.F., Shin, D-S., Sanders, T.G., and Hawrych, J.R., "Proposal for the Construction of Prestressed Concrete Super-Barge for Process Plants," Concrete Ships and Floating Structures Convention, Rotterdam, Nov. 1979.

3.0 APPLICATIONS AND EXPERIENCE

3.1 Overview

Current and historical examples of concrete structures in the marine environment can be divided into several major categories. These include

- Ship Structures
- Fixed Offshore Structures
- Barge Structures
- Harbor and Coastal Structures
- Other Structures

This chapter* will examine representative examples in each of these categories. The description presented of the World War II U.S. concrete ship program and the CONDEEP North Sea platforms contains detailed information concerning design considerations, materials, construction, and service experience. The construction effort during World War II was chosen because it is directly applicable to floating vessels, even though the data are 40 years old. The CONDEEP platforms are not floating structures, but do represent current technology in concrete design and construction in the marine environment. The state-of-the-art survey described in Chapter 2.0 also revealed more published information on these two examples. For the remaining applications, more general descriptions are provided, along with service experience where possible.

3.2 U.S. Concrete Ships Built During World War II

3.2.1 Background

During 1941, when demand for tonnage began to increase, consideration was given by the U.S. Maritime Commission to the use of materials other than steel plate for ship construction. As a result, it was decided, after considerable investigation, to inaugurate a program of reinforced lightweight-concrete vessels.

Construction of facilities and hulls began during 1942, and deliveries of concrete vessels started in 1943. In all, some 104 vessels were built at five concrete shipyards with five different types of design. Outline details are given in Table 3.1. All vessels constructed during this program except those built at Tampa were barges or lighters with no propulsion machinery. At Tampa, 24 self-propelled, dry-cargo vessels were built. The Savannah, Houston, and first National City vessels carried oil, and the San Francisco and second National City barges transported dry cargo [3.2].

*Some information in this chapter is quoted directly from published documents. In such cases, the appropriate reference will be noted at the end of each paragraph.

TABLE 3.1 PRINCIPAL FEATURES OF THE U.S. CONCRETE
SHIP PROGRAM OF WORLD WAR II
(FROM [3.1])

| Yards | Savannah & Houston | National City (1) | Tampa | San Francisco | National City (2) |
|-------------------------------------|-----------------------|----------------------|-----------------------|------------------|----------------------|
| Design Type | B7A1 | B7A2 | C1SD1 | B7D1 | B5BJ |
| Cargo | Oil | Oil | Dry | Dry | Dry |
| Length O.A., ft | 366 | 375 | 366 | 366 | 265 |
| Molded Depth, ft | 35 | 38 | 35 | 35 | 17.5 |
| Molded Beam, ft | 54 | 56 | 54 | 54 | 48 |
| Maximum Draft, ft | 26.25 | 28.50 | 27.25 | 26.25 | 12.75 |
| Displacement, tons | 10,940 | 12,890 | 11,370 | 10,970 | 4,000 |
| Longitudinal Bulkheads | 2 | 1 | None | None | 2 |
| Transverse Bulkheads | 10 | 10 | 10 | 10 | 5 |
| Transverse Bulkhead Spacing, ft | 32 | 32.75 | 32 | 32 | 48 |
| Transverse Frame Spacing | 10'-8" | 5'-5-1/2" | 10'-8" | 6'-5" | None |
| Bulkhead Thickness, in. | 4 | 4.5 | 4 | 4.25 to 7 | 6 |
| Bale Capacity, c.f. | 325,000 | 354,000 | 282,000 | 292,000 | 183,000 |
| Deck Thickness, in. | 4 | 4.75 | 5.50 | 5/6.25 | 7 |
| Side Thickness, in. | 4.25 | 4.5/5 | 6.5 | 6 | 8 |
| Bottom Thickness, in. | 5 | 5 | 6.5 | 7 | 8 |
| Framing System | Long'l. | Trans. | Long'l. | Trans. | None |
| Block Coefficient | 0.77 | 0.79 | 0.77 | 0.77 | 0.86 |
| Deadweight to Displacement Ratio | 0.53 | 0.50 | 0.47 | 0.53 | 0.42 |
| Power | None | None | 1300 IHP at 80 RPM | None | None |
| Reinforcing Steel, long tons | 1,360 | 1,520 | 1,120 | 1,004 | 430 |
| Concrete, cu yd | 2,940 | 3,200 | 2,890 | 2,440 | 1,500 |
| Number Built | 11 | 22 | 24 | 20 | 27 |

The 24 self-propelled vessels (design C1SD1) were classed by ABS as +A1 (full ocean service); the 11 Savannah and Houston barges (design B7A1) were classed as +A1 Fuel Oil Barge; the 27 second National City barges (design B5BJ) were classed as +A1 Barge, River and Harbor Service; the remaining 42 oil and dry-cargo barges were built under the supervision of ABS, but were not classed since they went directly into Armed Forces service [3.3].

Table 3.2 indicates that of the original 142 concrete vessels contracted for, 38 were cancelled. Vasta [3.4] attributed the cancellation of the 32 oil barges at the Savannah and Houston shipyards to production delays together with (1) a decrease in the urgent demand for oil barges because of completion of a gasoline pipeline, (2) the overcoming of the submarine menace, and (3) the breaking of all production records by the steel shipbuilding program. Six dry-cargo barges were cancelled at the San Francisco yard, not because of production reasons, but because of the lack of need for this type of vessel.

These 104 seagoing concrete vessels entered service with a total deadweight capacity (dwt) of 488,000 tons. While this was an impressive tonnage, the concrete fleet was dwarfed by the production of 2,800 Liberty ships made from steel, whose total capacity was 28,000,000 dwt [3.5].

3.2.2 General Descriptions of Hulls

The concrete ships constructed during 1942 to 1945 were essentially copies of those built between 1918 and 1920. That is, they imitated the traditional ship hull with transverse frames and bulkheads, and with longitudinal stiffeners. Figure 3.1 is an isometric view of the typical dry-cargo barge built by the Maritime Administration starting in 1942. It is evident that the lessons learned from the World War I shipbuilding program had been forgotten, and again a complex hull form featuring considerable transverse and longitudinal framing was used. At the expense of speed, simplicity, and economy of construction, emphasis was placed on the highest deadweight capacity or the lightest possible hull structure consistent with the required strength. Thus, the practical problems of construction were subordinated to the goal of a maximum deadweight-to-displacement-ratio ship [3.5].

The dry-cargo barges constructed at San Francisco (Figure 3.1) were probably the easiest hulls to build in the initial program. They had no horizontal beams in the bulkheads or shell except opposite the fenders, and the slab of tapering thickness was supported directly on ribs at 6-ft 4-in. centers. There were no longitudinal bulkheads. Transverse bulkheads were spaced at 32 ft. Slab thicknesses were 7 to 4-1/2 in. bottom to top in the transverse bulkheads, 7 to 6 in. bottom to top in the shell, 7 in. in the bottom, and 5 to 6-1/4 in. in the deck.

TABLE 3.2 CONCRETE SHIP PROGRAM - WORLD WAR II
(FROM [3.4])

| Design | Contracted Type | Number Contracted For | Number Cancelled | Total Built | Deadweight Tons Built | Operated By |
|--------|-----------------------------|-----------------------|------------------|-------------|-----------------------|---|
| B7A1 | Oil Barge | 43 | 32 | 11 | 59,730 | Navy |
| B7A2 | Oil Barge | 22 | -- | 22 | 140,250 | Navy |
| B7D1 | Dry-Cargo Barge (Converted) | 26 | 6 | 20 | 114,600 | Navy--18 Army-- 2 |
| G1SD1 | Dry-Cargo Steamer | 24 | -- | 24 | 130,320 | 17--converted for Army 2--delivered to Navy in United Kingdom, 5--in use by Army as training ships. |
| B5BJ1 | Dry Stores Lighter | 22 | -- | 22 | 35,200 | Army |
| B5BJ2 | Reefer Stores Lighter | 3 | -- | 3 | 4,800 | Army |
| B5BJ3 | Repair Ship Lighter | 2 | -- | 2 | 3,200 | Army |
| | TOTALS: | 142 | 38 | 104 | 488,100 | Navy--53 Army--51 |

3.4

486-328

(36)

(56)

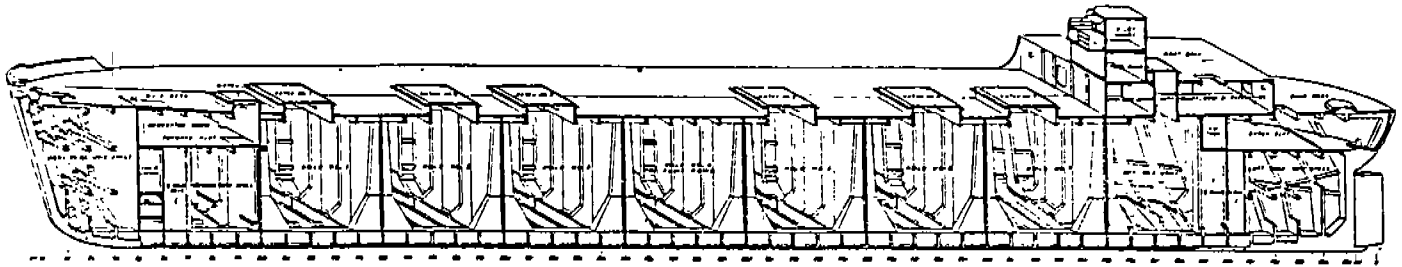

FIGURE 3.1 ISOMETRIC LONGITUDINAL SECTION OF DRY-CARGO HULLS BUILT AT SAN FRANCISCO (FROM [3.6])

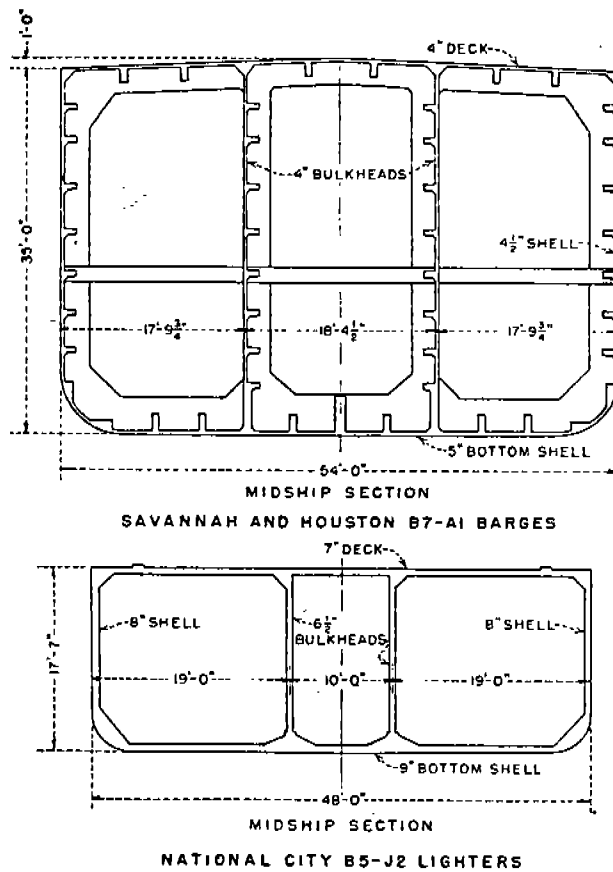

FIGURE 3.2 COMPARISON OF COMPLICATED AND SIMPLIFIED DESIGN (FROM [3.2])

The dry-cargo, self-propelled ship built at Tampa had transverse bulkheads at 32-ft centers with no longitudinal bulkheads except in one bay where there were two. These bulkheads form two 17-ft 5-1/2 in. by 32-ft wing ballast tanks with a 19-ft 1-in. by 32-ft void space between them. In these hulls, ribs on the shell and bulkheads were spaced on 10-ft 8-in. centers and carried horizontal beams at about 4-ft centers, which supported the 6-1/2-in. shell and 4-in. bulkhead slabs. Bottom slabs were 6-1/2 in. thick and the decks 5-1/2 in. thick.

The oil barges built at Savannah and Houston were identical in design. These hulls had two longitudinal bulkheads and ten transverse bulkheads. These transverse bulkheads, on 32-ft centers, formed the midship or parallel body section center tanks, 18 ft 4-1/2 in. by 32 ft, and wing tanks, 17 ft 9-3/4 in. by 32 ft. Transverse rib framing was spaced at 10-ft 8-in. centers, and it supported a system of horizontal beams at approximately 4-ft centers. These in turn supported the 4-1/2 in. shell and 4-in. bulkhead slabs, as shown in Figure 3.2. The bottom slab was 5 in. thick, the deck 4 in.

The oil barges (B7A2) built at National City, California, had only one longitudinal bulkhead at the centerline. This fact and the use of rib frames at 5-ft 5-1/2-in. centers, without horizontal beams for the side shell (except behind fenders), resulted in an appreciably simpler structure, easier to construct than the other oil barges of the program. Transverse bulkheads were spaced at 27-ft 2-1/2-in. centers and were carried on a system of vertical ribs held by tie beams or struts at midheight. Bulkhead and sideshell slabs were 4-1/2 to 5 in. thick, bottoms were 5 in., and decks, 4-3/4 in.

In frames and beams for all four of these hulls, bars up to 1-1/4 in. square were used in various amounts and patterns with closely spaced stirrups. The general detail of steel in the shell, bulkhead, and deck slabs for all hulls is shown in Figures 3.3 and 3.4. It was necessary to embed about one-half ton of steel in each cubic yard of concrete.

Of entirely different design were the 27 lighters built at the National City yard in 1944. Two longitudinal bulkheads 10 ft apart provided void spaces on the centerline, as shown in Figure 3.2. Six transverse bulkheads separated the remaining space into 12 cargo holds, approximately 19 by 48 ft, and the void space at the fore peak. This hull was unencumbered with ribs, beams, frames, columns, pilasters, or struts (as shown in Figure 3.2). Shell sides, bottom, deck, and bulkheads were flat slabs completely unrelieved except for haunches at the connections and corners. Bulkhead slabs were 6-1/2 in. thick. The transverse bulkheads were precast in one piece, and the longitudinals precast in lengths between transverse bulkheads. In some hulls all 20 pieces, most of them weighing 22 to 24 tons each, were set in less than three hours. There was no welding of bottom and side connections, as protruding bar details were shaped to

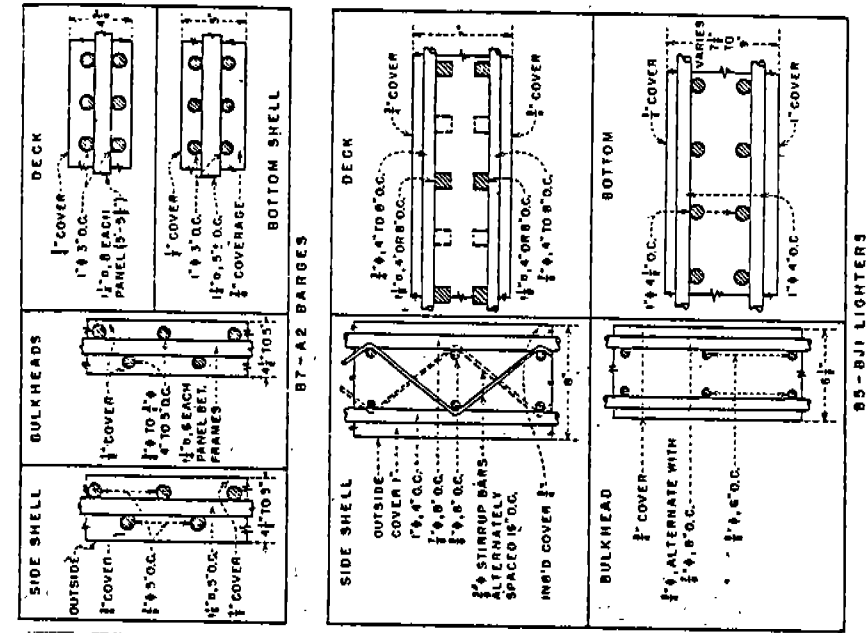

FIGURE 3.4 REINFORCING DETAILS - NATIONAL CITY HULLS (FROM [3.2])

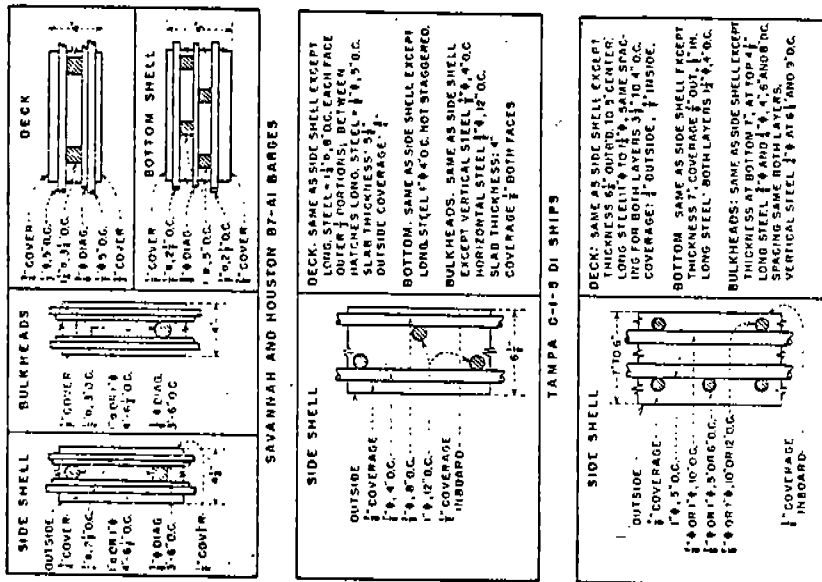

FIGURE 3.3 HULL REINFORCEMENT DETAILS (FROM [3.2])

become interlocked with steel in the bottom, side shell, and deck. Longitudinal steel, 5/8 in. round at 6-in. centers, protruded from both ends of the precast lengths of longitudinal bulkhead and was welded to similar bars which pierced the transverse bulkhead at the intersections. The 15-in. slots where this welding was done were concreted separately before setting the deck forms. The bottom slab was 7-1/2 to 9 in. thick, the sides 8 in., and the deck 7 in. [3.2].

With straight slab construction of these thicknesses, absence of ribs and beams, and with the reinforcing steel spaced to allow general access for the internal vibrators, these hulls were designed for efficient concrete construction. One of them was actually built and launched in 6-1/2 days. Because of the thicker walls and surer placing of the 2- to 3-in. slump concrete, no cracks or leaks developed in the shells during hydrostatic testing. This radically new design was far better suited to reinforced concrete than any of the earlier designs, which consisted largely of the substitution of a reinforced concrete member for the corresponding member of a steel ship, and it eliminated almost entirely the complications in steel setting, form construction, and concrete placing which caused relatively slow construction and high costs in the earlier vessels.

3.2.3 Design Considerations

The structural design of the World War II concrete ship was based on the following loading assumptions [3.1]:

1. The midship strength should extend over the middle half length of the ship.
2. Structural members should be designed to carry their own weight plus loading as follows:
 - a. An external hydraulic head of 6 ft on the main deck and no other loads.
 - b. An external hydraulic head extending to 2 ft above edge of deck with no load on deck or other local loads.
 - c. An external hydraulic head of 10 ft above the bottom plus an internal hydraulic head of 20 ft above the bottom and no other local loads.
 - d. An external hydraulic head extending 2 ft above the deck edge plus an internal hydraulic head of equal amount in any compartment.
3. The loading condition for transverse bulkheads is given under condition 2.d above.
4. Tanks of reinforced concrete, made a part of the hull structure, were designed for an internal head extending to the top of the tank.

5. Flats and space not otherwise designed for definite loads were designed for a live load of 200 psf. Supporting members for heavy equipment or other concentrations of load were designed to carry such a load (whenever it exceeded 200 psf).
6. All decks above the main deck and the main deck within the house were designed for a live load of 75 psf and all tops of houses for a live load of 50 psf. Supporting members for heavy equipment or other load concentrations were designed for such loads whenever they exceeded the specified live load for that space.
7. The hull as a girder in bending was designed to have sufficient longitudinal strength to satisfy the two following conditions:
 - a. A bending moment in foot-tons equal to:

$$\frac{0.75 L^2 B d}{(35)^2},$$

in which L is the length between perpendiculars, B the molded beam, and d the full-load draft, with a corresponding stress in the steel of not more than 15,000 lb/in.², as determined by dividing the above bending moment by the appropriate section modulus of the hull as a girder. The stresses induced by local loading need not be considered in investigation under condition a.

- b. Hull bending moment stresses determined by detailed computations based on the final hull form lines, when combined with local stresses, shall not exceed the values given in the specifications. The hull shall be considered as a girder supported on a "standard" trochoidal ship-length wave (the length of which is 20 times its height from trough to crest) in both "hogging" and "sagging" conditions. Deep loading conditions only need be investigated for obtaining the stresses which must be so combined. Table 3.3 gives the design bending moments and shearing forces for the various hull designs.

Various other requirements were specified in making the design analysis. The ratio of the modulus of elasticity of steel to the modulus of elasticity of concrete, commonly known as "N," was assumed equal to 12. The various allowable unit stresses were specified as shown in Table 3.4. The stresses shown in this table were the maximum permitted. Combined stresses occurring simultaneously were not permitted to exceed these values. In order to keep tension cracks in the concrete under flexure and/or direct tension to a minimum, the maximum allowable unit stresses in the steel were held relatively low in the bottom and sideshell.

TABLE 3.3 DESIGN BENDING MOMENTS (BM) AND SHEARING FORCES (FROM [3.4])

| Design | Construction Type | Calculated Bending Moments ₃ (Ft.-Tons) | | Design Shear Tons ₃ | Design Bending Moments ₄ (Ft.-Tons) | | Reinforcing Steel Long Tons* | Cubic Yards Concrete* |
|----------------|-------------------|---|----------------------|--------------------------------|---|---------|------------------------------|-----------------------|
| | | Sagging ₁ | Hogging ₂ | | Sagging | Hogging | | |
| B7A1 | Longitudinal | 92000 | 94000 | 854 | 106200 | 106200 | 1360 | 2940 |
| 7A2 | Transverse | 61200 | 76200 | 931 | 126600 | 126600 | 1520 | 3200 |
| C1SD1 | Longitudinal | 49550 | 91500 | 1180 | 106200 | 91500 | 1120 | 2890 |
| B7D1 | Transverse | 59700 | 80000 | 913 | 106200 | 80000 | 1004 | 2440 |
| B5BJ1 | Slab-Ribless | 28000 | 28000 | 365 | 19300 | 19300 | 430 | 1500 |
| B5BJ2 B5BJ3 | Slab-Ribless | 34000 | 34000 | 450 | 19300 | 19300 | 430 | 1500 |

Notes:

- * - Average values per vessel
- 1 - Full load condition
- 2 - Light ship condition
- 3 - Derived from standard strength calculations
- 4 - Design BM required by regulatory bodies

3.10

486-328

(42)

(42)

TABLE 3.4 ALLOWABLE UNIT STRESSES, PSI
(FROM [3.5])

| | |
|---|--------|
| Concrete - based on 5,000 psi = f'_c | |
| Compression in concrete | 2,250 |
| Shear, hull girder (with no steel reinforcement for shear) | 100 |
| Shear, hull girder (with steel reinforcement for excess of shear over 100 psi) | 200 |
| Shear, hull girder (with steel reinforcement for entire shear) | 500 |
| Shear, beams and frames and slabs (without steel reinforcement for shear) | 150 |
| Shear, beams and frames (with steel reinforcing for shear over 150 psi) | 300 |
| Shear, beams and frames (with steel reinforcing for entire shear) | 500 |
| Bond, for plain bars | 160 |
| Bond, for deformed bars | 200 |
| Tension in concrete | None |
| Compression in steel | 16,000 |
| Tension in steel between the inner and outer faces of shell sides below load water line and bottom slab | 12,000 |
| Tension in steel in deck slab | 16,000 |
| Tension in stirrup steel in beams and frames | 16,000 |
| Tension, elsewhere | 20,000 |

3.2.4 Materials and Construction

At the very beginning of the program, consideration was given to the use of lightweight aggregates instead of natural sand and gravel for the concrete. Preliminary weight estimates dictated the necessity for this action, for it was essential to lighten the hull structure if the barges were to be of much value for carrying cargo [3.4].

Concrete made of natural sand and gravel weighs about 150 lb per cubic foot. A high-strength, lightweight concrete, however, can be made to weigh about 110 lb per cubic foot. Concrete having approximately this density was successfully used in the program. To develop this lightweight concrete, an investigation was undertaken of all available types of lightweight aggregates, both natural and manufactured. It was found that the only material actually available in dependable quantity which would produce concrete of the required 5000-psi compressive strength was a manufactured product known as Haydite. Haydite was very similar to the artificial lightweight aggregate used with apparent success in the World War I program. The investigation brought out the fact that considerable difficulty would be experienced in handling, mixing, and controlling the concrete mixes using light aggregates. Segregation of the aggregates in the mix during placing was a serious problem with lightweight concrete. High slumps aggravated this condition, permitting the coarse material to come to the top of a lift under vibration. Curing was also of special importance with these lightweight materials because of the high water absorption. If the interior of the concrete retained a large amount of absorbed water, surface drying aggravated the tendency of the concrete to shrink and craze [3.4].

In spite of all these difficulties, the decision was made to use a lightweight concrete. This material was more costly than that made of natural sand and gravel, but the monetary disadvantage had to be accepted in the program in order to achieve a reasonable deadweight cargo efficiency [3.4].

Haydite, a manufactured lightweight fine and coarse aggregate, constituted the largest volume of lightweight material, although Rocklite and Nodulite were also used. At one time or another, Haydite was used in all yards and came from three plants-- San Rafael, California; Kansas City, Missouri; and East St. Louis, Illinois. Haydite is rough, sharp, and angular and is made by crushing and screening the clinkered product of suitable shale burned in a rotary kiln at a temperature of about 2000° to 2100°F until the degree of vesiculation necessary to produce material of the desired unit weight and strength is obtained.

Rocklite was manufactured in a small new plant at Ventura, California, and the entire output was used at the National City yard. It was produced as an individual, nearly spherical, particle with a thin shell and vesiculated interior in coarse sizes only. It was made by crushing, screening, and burning appropriate sizes in a rotary kiln at a temperature of about 2170°F. Despite the irregular shape of the particles

as they enter the kiln, the processing and expansion during burning resulted in a well-rounded material [3.2].

Nodulite was made in a large new plant at Ellenton, Florida, and was used only at the Tampa yard. It was a coated, vesiculated, spherical particle produced by burning in a rotary kiln at about 2050°F. The nodules were prepared for kiln feed by a "nodulizing" process in which pulverized and dried Fuller's earth was fed into a large revolving drum containing adjustable water sprays and came out as rather hard, damp balls ranging in size from 1/16 to 1 in., which shrank considerably in burning. The nodules were dusted with fine silica sand to prevent them from sticking together when burning. After burning, all oversizes and some excess intermediate sizes were crushed, rolled, and blended in screening with the kiln-run fine nodulite aggregate [3.2]. Typical average physical properties of the various aggregates used are shown in Table 3.5.

Type II modified portland cement was selected for the hull concrete because of its moderate heat of hydration (important because of the massive ribs and beams in relation to thin shell structure), its expected durability, and its better resistance to sulfate waters. For these reasons, the manufacturers were encouraged to supply cements that were as far toward low heat and sulfate-resisting compositions as practicable and yet gave adequate strength at 10 and 28 days. Table 3.6 lists the general properties of cements used in the various yards. Moderately high fineness was considered desirable because of the importance of reducing bleeding for the enhancement of water tightness and the benefit of workability [3.2].

Table 3.7 lists the engineering properties for the concrete mixtures. To secure an ample margin of strength over the required 5 ksi at 28 days and high values of tensile strength and watertightness, about 33 lb/ft³ of cement was used in most mixes.

The first concreting operation of the program was begun at National City, California, where a mix was used having a slump of about 2-1/2 inches. Because of the relatively high stiffness of this mix, which made placing of concrete a difficult operation, means were explored to increase the fluidity of the concrete without adding more water. This consideration led to the use of admixtures. The ideal admixture is one which increases slump without requiring increases in the water content, reduces bleeding and segregation, does not adversely affect the strength, and results in no volumetric changes. One such admixture which accomplished the desired purpose was commercially available and was specified as a requirement to the various building yards. Amounts used varied from 3/8 to 1/2 pound per sack of cement, equivalent to 4 to 5 pounds per cubic yard of concrete. The admixture cost was about 11 cents per pound, a high price to pay, but a necessary one in order to facilitate and ensure a satisfactory concrete operation [3.4].

(45)

TABLE 3.5 TYPICAL PHYSICAL PROPERTIES OF LIGHTWEIGHT AGGREGATES USED IN U.S. CONCRETE SHIPS (FROM [3.6])

| Type of aggregate | Size of aggregate (mm) | Density (dry loose) (kg/m ³) | Bulk specific gravity (dry) | Absorption (%) |
|---------------------|------------------------|--|-----------------------------|----------------|
| E. St Louis Haydite | 12 | 640 | 1.09 | 23 |
| | 9 | 656 | 1.14 | 21 |
| | No. 8 | 800 | 1.24 | 20 |
| Nodulite | 12 | 672 | 1.29 | 8 |
| | 9 | 736 | 1.42 | 8 |
| | No. 4 | 976 | 1.86 | 7 |
| Rocklite | 20 | 592 | 1.19 | 16 |
| | 12 | 672 | 1.21 | 19 |
| | 9 | 704 | 1.25 | 19 |

TABLE 3.6 TYPICAL MIX DESIGN FOR CONCRETE USED IN U.S. CONCRETE SHIPS (FROM [3.6])

| Lightweight aggregate | | Mix proportions (% by solid volume) | | | | | Admixture (% by weight of cement) | Cement content (kg/m ³) | Water/cement ratio by weight | Slump (mm) |
|-----------------------|---------------------|-------------------------------------|------------------------|-------|-------|-------|-----------------------------------|-------------------------------------|------------------------------|------------|
| | | Natural sand | Lightweight aggregates | | | | | | | |
| Fine | Coarse | | | Fines | ¾ in. | ½ in. | ¾ in. | | | |
| E. St Louis Haydite | E. St Louis Haydite | 15 | 35 | 50 | | | 0.5 | 580 | 0.47 | 135 |
| Nodulite | Nodulite | 15 | 35 | 20 | 30 | | 0.5 | 540 | 0.50 | 115 |
| — | Rocklite | 48 | — | 16 | 36 | | 0.375 | 550 | 0.45 | 90 |

TABLE 3.7 ENGINEERING PROPERTIES OF CONCRETE USED IN U.S. CONCRETE SHIPS (FROM [3.6])

| Lightweight aggregate | | Cylinder compressive strength (N/mm ²) | | Unit weight of fresh concrete (kg/m ³) | Modulus of elasticity at 28 days (kN/mm ²) |
|-----------------------|---------------------|--|--------|--|--|
| | | 28 day | 1 year | | |
| Fine | Coarse | | | | |
| E. St Louis Haydite | E. St Louis Haydite | 38.5 | 50 | 1740 | 16.6 |
| Nodulite | Nodulite | 39.0 | 49 | 1855 | 16.7 |
| Natural sand | Rocklite | 43.5 | 53 | 2000 | 23.0 |

(46)

After extensive investigations and consultations with a number of authorities, the following basic mix was developed. The maximum size of the coarse aggregate was not to exceed 1/2 inch. This was dictated by the very narrow clearances between reinforcing bars. The ratio of coarse to fine aggregates was maintained at one. A cement content of 9 sacks per cubic yard was specified in order to obtain the 5000-psi compressive strength. A water-cement ratio of about 5-1/4 gallons per sack of cement was fixed in order to achieve a slump of 2-1/2 in., which was believed placeable [3.4].

One of the major problems in the construction of the concrete hulls was the fabrication and erection of forms. For each hull, which required between 2500 and 3000 cubic yards of concrete, about 250,000 square feet of form surface was needed. Oil-treated or lacquered plywood, 3/4 in. thick, was used exclusively. Solid, heavy scaffoldings were built to hold the exterior forms rigidly in place. Inside forms were built in small, panel sections, to be set quickly and tightly in place as the concreting operation progressed [3.4].

The close tolerances and precision required in this form work were difficult to realize. A large portion of the shell area was not flat but shaped. The shell, which ranged from 4-1/4 to 6 in. thick, contained three or more layers of steel reinforcing bars. The outer layer of steel had to have a minimum concrete coverage of 3/4 in. for those portions of the shell in contact with the water and 1/2-in. coverage elsewhere. This coverage had to be maintained within extremely close tolerances to prevent possible penetration of sea water to the steel or significant increases in the weight of the hull structure. The accuracy required in placing concrete, the necessity for providing rigid support, the unavoidable cramped spaces in the interior, and the heavy bracing necessary for the small segments of the interior form were all contributing factors in making the form work a job of unusual difficulty and high cost [3.4].

A very high percentage of steel was used in the construction program. This varied from 6 to 8-1/2 percent by volume and averaged roughly 800 to 1000 pounds of steel per cubic yard of concrete. Nearly 500,000 pieces of reinforcing bars were used in the fabrication of each oil barge; a lesser quantity was required in the dry-cargo vessels. This steel had to be placed with great accuracy since the space tolerances had to be maintained to within a very small fraction of an inch. To a large extent the bars were placed piece by piece in the hull. Prefabrication, however, was employed where economical. For example, in the B7D1 design it was possible to preassemble a large portion of the reinforcing steel to facilitate installation in the hull. In this case about 400 tons of steel framing per ship was built on jigs and welded into rigid skeleton units. The grids of longitudinal and transverse bars were welded at their intersection. With the B5BJ1 lighters, all transverse and longitudinal bulkheads were precast [3.4].

The first step in steel erection after the outer forms were in place was to place the outboard layer of steel bars in position. These bars were supported and spaced from the forms by means of small concrete spacer blocks about 2 in. square with a thickness corresponding to the required coverage. The other layers of steel were then added to the first layer and the process repeated until the required amount was properly placed. The various layers were tied together or tack welded at their intersections, through short spacer bars, to form a rigid self-supporting steel skeleton [3.4].

As the steel erection progressed, it was necessary to locate and secure the various inserts, such as sea chests, fender bolts, hatches, bases, and anchorages for various items of deck equipment. These inserts had to be placed accurately and held rigidly in position during the concreting operations [3.4].

An effort was made to use interlocking spiral or helical reinforcing in the sideshell of the self-propelled ships built at Tampa. This type of reinforcing greatly increased the resistance of the concrete to impact and added significantly to the shear resistance of the panel. Not much progress was made with this scheme, however, until the B5BJ1 concrete lighters were designed. In these barges, an interwoven type of reinforcing steel believed to accomplish results similar to the spiral was used in the sideshell. This, probably, could have eliminated the necessity for providing wood fenders to increase the impact resistance [3.4].

3.2.5 Proving the Designs

Since the structural design of the concrete vessels had to be developed with assumptions governing the intensity of loads, their distribution, and the interaction of the structural elements, it became increasingly important that efforts be made to study the structural performance of the hull under full-scale testing, mainly to verify the assumptions that governed the design. Accordingly, a program for testing a number of hulls was agreed to. Plans were made to check the hull girder strength, to study the strength of the framing system, to evaluate the strength of large unstiffened panels under hydrostatic loads, and to ascertain the stress concentrations in the way of the main deck hatch corners for the dry-cargo vessels [3.4].

These tests were carried out at the construction yards with the hulls structurally complete. Six concrete vessels were tested, covering four of the five designs. The B7D1 dry-cargo barge design was the only one not tested because sufficient reliable information had already been collected from previous work to indicate that this design would be structurally sound. In most cases, the applied loading was obtained by filling certain designated spaces with water. With the oil barges, this operation was a simple matter because the vessels were designed for liquid cargo. In the tests of the dry-cargo ships, attention had to be given

to the stability of the vessels due to the large free surfaces resulting from filling the cargo spaces with water. In the case of the C1SD1 built at Tampa, advantage was taken of the launching of the vessel to measure the stress field around a cargo hatch by the change in bending moment induced on the structure as the vessel became waterborne. Two tests were made on the oil barges to determine the strength of a typical midship transverse frame when loaded with an internal head of water 8 ft above the main deck while the hull was supported on docking blocks. Two additional tests were made to determine the hull girder strength concurrently with the local behavior of a few specific structural members [3.4].

The first tests were conducted on the West Coast oil barge design B7A2. The results from these tests were most encouraging and created considerable confidence in the analytical methods used in the structural design. The distribution of stresses followed the predicted pattern. The measured steel stresses, however, were about 50 percent smaller than those predicted from calculations based on the conventional design practice of neglecting the tensile value of the concrete. Although the applied loads approached closely the design values, they did not produce any tension cracks in the concrete. Yet, concrete stresses of the order of 700 psi were measured. Presumably, concrete and steel were acting as a homogeneous material in resisting both tension as well as compression [3.4].

In general, the results of these structural tests confirmed the behavior predicted by theory on the assumption of a homogeneous structure. This means that the structure behaved as an "uncracked" girder with steel tensile stresses not exceeding 8000 psi. The latter value is considerably below the design stress of either 12,000 or 16,000 psi and reflects the significant contribution provided by the concrete proper [3.4].

The monolithic action of the hull structure under high applied loads that approach design values undoubtedly gives a margin of strength over that considered in the design. However, the ability of the concrete to take tensile stresses, though encouraging, could not be utilized in subsequent designs. To rely on concrete to resist tensile forces consistently would have meant departing radically from accepted standards in reinforced concrete design. It is suspected that after concrete reaches a certain age, shrinkage cracks may develop which will destroy the homogeneity of the structure. It is at this stage that the tensile load on the structure is resisted by steel only. Although ordinary shore concrete structures generally develop such cracks, it is not definitely established that similar behavior is experienced by a floating hull structure, which has a much larger percentage of reinforcing steel (6 to 8-1/2 percent by volume) than most land installations, and which has a better opportunity to remain moist most of the time [3.4].

3.2.6 Construction Costs

The construction cost of the reinforced concrete ship program was higher than had been estimated at the beginning of the program. There were many factors contributing to this high cost. The work was new, with no background of knowledge and experience to indicate proper procedure that might serve as a guide. The early efforts to save weight in order to improve the deadweight efficiency led to the adoption of a design featuring a thin shell reinforced with many closely spaced longitudinal stiffeners. The design was found to be difficult to form and presented many concrete pouring problems aggravated by the highly congested sections. The use of lightweight aggregates introduced problems which affected the handling of the material and the curing of the concrete. Moreover, since the program started as an experimental venture, the facilities and equipment in the initial yards were inadequate. Labor costs ran higher than anticipated. The oil barges had to be relined with expensive protective coating in order to make them suitable for carrying high octane aviation gasoline. The tank testing procedure as a requirement for classification was too rigorous and severe. The crews' quarters requirements were expanded, and additional equipment became necessary over and above the amounts specified in the original contract. Conversion of nearly completed vessels to special uses for the Armed Forces involved additional costs. This affected most of the San Francisco dry-cargo barges and most of the Tampa self-propelled vessels [3.4].

Table 3.8 shows the cost breakdown for these World War II concrete ships. In the Savannah and Houston yards, where only 11 of the original 43 contracted barges were completed, the vessel cost per deadweight ton was \$550.

The more efficiently managed yards, however, demonstrated not only a lower unit cost, but a schedule of production considered highly satisfactory. At National City, where almost 50 percent of the ships were built, modern methods of construction were adopted which cut the costs to a value that compares favorably with the more efficient yards engaged in production of steel ships [3.4].

3.2.7 Service and Experience

All vessels constructed under the Maritime Commission program were in service to some extent. They carried a variety of cargoes, including sugar, wheat, coffee, diesel oil, and aviation gasoline. Some of the small 4000-ton displacement lighters were provided with refrigeration and carried perishable cargo [3.4].

The 24 self-propelled dry-cargo vessels, intended originally for the sugar trade between Cuba and the Atlantic seaboard, were delayed in completion and only four of them were used in this trade. The first two, after operation for a short period, were withdrawn from commercial service and delivered to the Navy at English Channel ports. They were later sunk as part of the Normandy Beach breakwater. Five more were removed from private operation and delivered to the Army, which used them for training ships. The remaining 17 were later converted into floating storehouses for small stores and were operated by the Army [3.4].

TABLE 3.8 COST SUMMARY - CONSTRUCTION AND FACILITIES (FROM [3.4])

| Shipyard | Savannah | Houston | National City | San Francisco | Tampa | National City | National City | National City |
|---|-------------|-------------|---------------|---------------|-------------|---------------|---------------|---------------|
| Design | B7A1 | B7A1 | B7A2 | B7D1 | C1SD1 | B5BJ1 | B5BJ2 | B5BJ3 |
| Number Of Ships Built | 7 | 4 | 22 | 20 | 24 | 22 | 3 | 2 |
| No. Of Building Ways | 6 end | 2 side | 4 basins | 6 basins | 3 basins | - | - | - |
| Size Of Ways Length x Width In Feet | 373x75 | 783x87 | 425x76 | 1195x60 | 405x82 | - | - | - |
| Average Cost Per Vessel | \$3,250,000 | \$2,529,000 | \$1,326,000 | \$1,234,000 | \$2,099,000 | \$ 403,000 | \$1,084,000 | \$1,268,000 |
| Total Cost Yard Facilities | \$1,794,000 | \$2,567,000 | \$2,672,000 | \$2,964,000 | \$5,515,000 | - | - | - |
| Total Deadweight Tons Built | 59,730 | | 140,250 | 114,600 | 130,320 | | 43,200 | |
| Vessel Cost Per dwt | \$550 | | \$208 | \$215 | \$387 | | \$339 | |

3.19

486-328

(51)

(57)

These ships suffered no catastrophic failures due to hull bending despite the fact that the self-propelled vessels experienced rough seas. It should be remembered that these were reinforced concrete hulls and no prestressing was used. For example, the *S.S. Aspdin* experienced a hurricane off Cape Hatteras in 1944. The wind was estimated at 193 km/hr (120 miles/hr) and the waves from 15.25 to 30 m (50 to 100 ft). The captain reported the ship pitched somewhat, but there was no rolling, panting, weaving, or pounding, nor any injuries to the crew [3.7].

All of the 80 barges went into government service and were not kept in class. The Navy operated the 33 oil barges (B7A1 and B7A2) in the South Pacific area and used them as floating oil storage tanks at advanced bases. Reports from the 11th Naval District indicated that these barges performed in a very satisfactory manner, showing themselves especially resistant to fire, bomb hits, and near misses [3.4].

Of the 20 dry-cargo barges (B7D1) initially designed as bulk carriers, 18 were converted into floating storehouses for dry-cargo stores. These vessels were operated by the Navy in the Southwest Pacific area at advanced bases as mobile storehouses. The remaining two barges were taken over by the Army, which operated them also at advanced bases in the South Pacific. The 27 lighters (B5BJ), two of which were equipped as machine shops and three as refrigerator ships, were operated by the Army at the same theater of war [3.4].

A dramatic demonstration of the durability of these World War II concrete barges was reported in U.S. papers in descriptions of the 1946 Bikini Atoll nuclear bomb tests [3.8]:

"In the Bikini test two concrete fuel barges and a concrete drydock survived the blast, which sank five ships and damaged at least three score. One barge, No. 2160, was badly charred when the bomb ignited cargo fuel oil stored on her, but she was apparently in good shape otherwise with her decks well above the water line. The remaining yard oiler and the drydock, both farther removed from the blast center, suffered no apparent damage. Oiler 2160 was moored only a hundred yards from the *Nevada*, the bullseye for the test. Today the oilers were being towed in for a closeup inspection by naval construction men. In this same target area the carrier *Independence* was all but destroyed by the blast and subsequent fires, the cruisers *Pensacola* and *Salt Lake City* emerged with smashed stacks and superstructure, and the battleships *Pennsylvania* and *Arkansas* were so wrecked above the waterline they would have been useless in a naval engagement."

In its report on these lightweight concrete ships, the U.S. Maritime Commission noted that the hulls appeared to be completely watertight, with good riding qualities and little vibration. In addition,

the interiors were cooler and more comfortable. The report concluded by saying:

"There is ample evidence that concrete hulls are dependable, seaworthy and structurally as sound as hulls of any other material used for seagoing vessels. Concrete hulls have been put to as severe tests as have been given any other vessels and it has been shown conclusively that when properly designed, properly built and well equipped, they will perform on an equal basis with comparable steel vessels." [3.6]

3.3 CONDEEP North Sea Platforms

3.3.1 Background

Of the 17 large concrete structures, either under construction or installed in the North Sea, six have been of the CONDEEP type (Table 3.9). All of the platforms, except the Frigg TCP2, are involved in drilling, production, and storage of oil from the North Sea fields. Storage capacities vary from 0.93 to 2.0 million barrels. The Frigg TCP2 is designed for treatment, compression, and production in an already producing field and has no storage capacity. Design water depths for the six CONDEEP platforms range from 104 m to 149 m (340 ft to 490 ft).

A graphical representation of the overall geometry and locations of these structures is given in Figure 3.5. The CONDEEP concept was developed by A/S Høyer Ellefsen and the Aker Group [3.10]. The designs of all six structures are similar, with changes made to account for variations in water depth, design wave height, soil condition, and functional requirements. The Norwegian Contractors were the general contractors for the civil engineering work on all platforms. Their duties included construction of the concrete structure, some mechanical design and installation, deck mating to the structure, towing to the site, and offshore installation. The first five CONDEEP platforms were concrete gravity structures consisting of a base of 19 cylindrical cells and three concrete shafts supporting a steel deck [3.9]. The sixth, Statfjord B, has 24 cells and four concrete shafts. This increased base diameter, from 100 m (330 ft) to 169 m (555 ft), was due primarily to the reduced soil capacity at the Statfjord B site.

3.3.2 Main Features of the CONDEEP Structures

The general features of a three-tower CONDEEP structure are given in Figure 3.6.

o Foundation

The foundation of the platform consists of a lower dome of star cells and a cantilevered slab which extends outside the external

53

TABLE 3.9 CONDEEP STRUCTURES (FROM [3.9, 3.12])

| Type of Design Location | Main Function | Design Wave Height (m) | Water Depth (m) | Approx. Concrete Volume (m ³) | Base Diameter (m) | Storage Capacity (Mill. bbl) | Deck Size LxBxH* (m) | Area (m ²) | Self-Weight (tons) | Maximum Weight (tons) | Installation Year |
|---------------------------|-----------------------------------|------------------------|-----------------|---|-------------------|------------------------------|----------------------|------------------------|--------------------|-----------------------|-------------------|
| 1 CONDEEP BERYL A (UK) | Drilling, Production, Storage | 29.5 | 120 | 55,000 | 100 | 0.93 | 72 x 70 x 10 | 3,650 | 6,500 | 32,000 | 1975 |
| 2 CONDEEP BRENT B (UK) | Drilling, Production, Storage | 30.5 | 142 | 65,000 | 100 | 1.0 | 72 x 70 x 6 | 3,650 | 4,200 | 26,000 | 1975 |
| 3 CONDEEP BRENT D (UK) | Drilling, Production, Storage | 30.5 | 142 | 65,000 | 100 | 1.0 | - | - | - | - | 1976 |
| 4 CONDEEP STATFJORD A (N) | Drilling, Production, Storage | 30.5 | 149 | 88,000 | 110 | 1.3 | 86 x 83 x 10 | 5,000 | 7,000 | 42,000 | 1977 |
| 5 CONDEEP FRIGG TCP2 (N) | Treatment, Compression Production | 29.0 | 104 | 50,000 | 100 | - | 84 x 63 x 10 | 4,500 | 3,500 | - | 1977 |
| 6 CONDEEP STATFJORD B (N) | Drilling, Production, Storage | 32.0 | 149 | 135,000 | 169 | 2.0 | 116 x 88 x 28 | - | - | 50,000 | 1981 |

UK = United Kingdom

N = Norway

* = Length x Breadth x Height

3.22

486-328

(54)

(54)

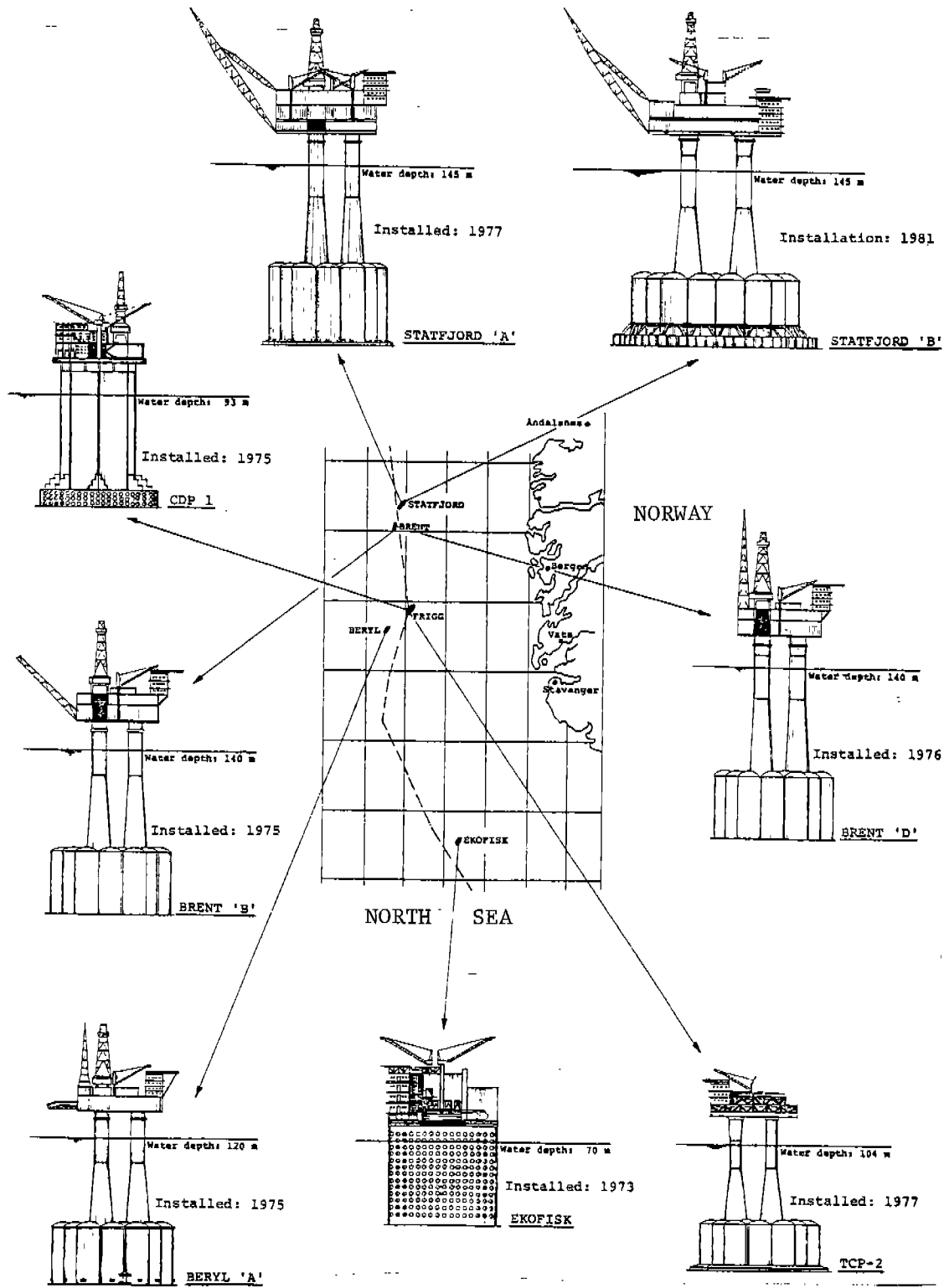
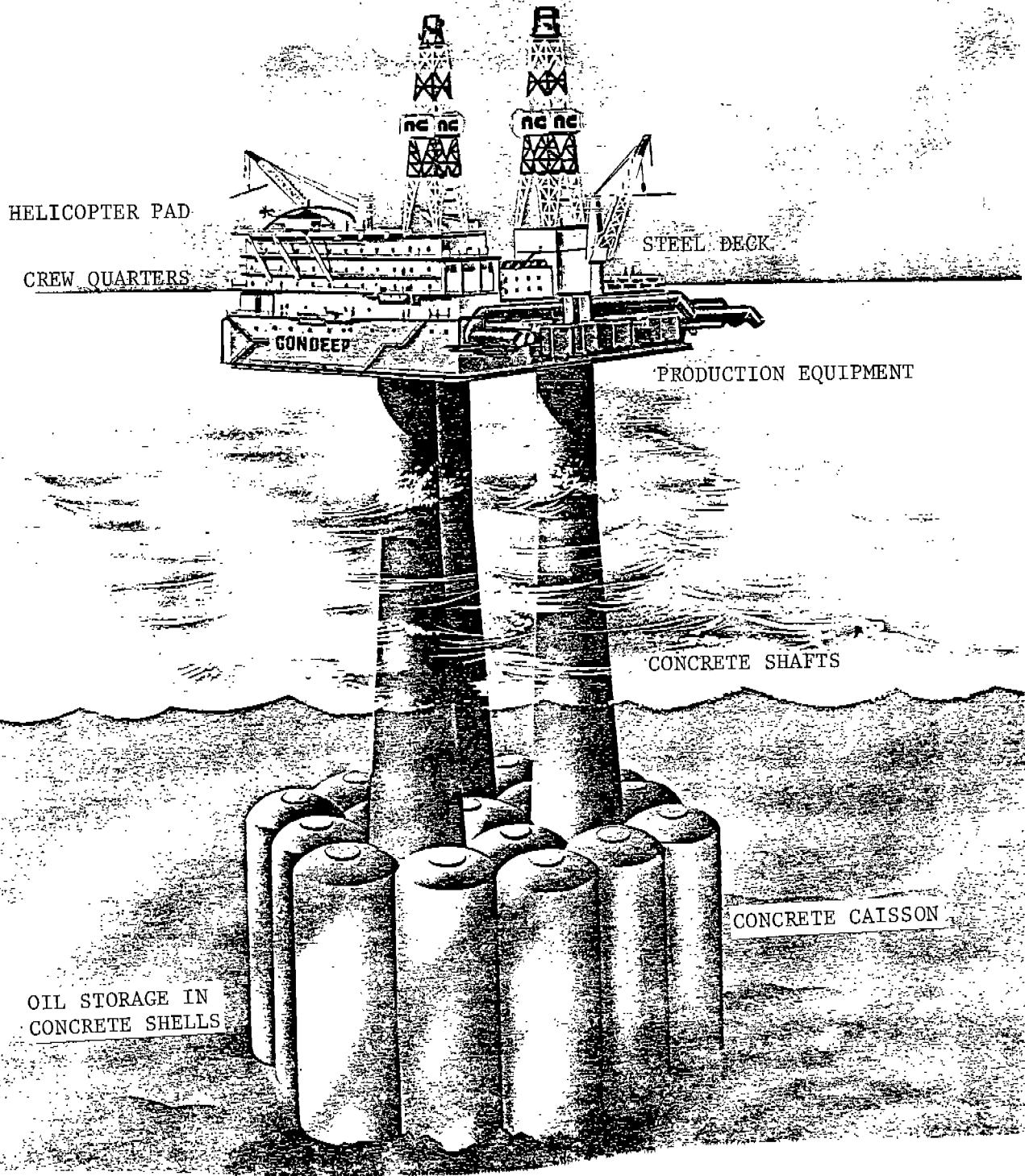

FIGURE 3.5 CONDEEP PLATFORMS, GEOMETRY AND LOCATION (FROM [3.10])



10
A.T.

FIGURE 3.6 GENERAL FEATURES OF A 3-TOWER CONDEEP PLATFORM

cells. The slab size and reinforcing details were adjusted to meet the soil conditions and seabed unevenness. Cell walls go somewhat below the lower domes to form a concrete skirt. The central cell, 12 outer cells, and cantilevered slabs were provided with a steel skirt. The skirts increase the connection between the structure and the ground on which it is laid and prevent the platform from sliding during the installation phase [3.11].

- o Caisson

The caisson consists of 19 or 24 cylindrical cells with a diameter of 20 m or 23 m and a cell wall thickness of 0.60 m. The cells are constructed of reinforced concrete and are capped with hemispherical domes. These cells provide ballast during the towing stage, and oil storage facilities during production.

- o Columns

The three or four columns are extensions of the caisson cells and are designed to support the deck. They are constructed of reinforced concrete with longitudinal prestressing. The columns have a conical shape with typical dimensions of 20 m to 10.4 m for the outside diameter and 0.85 m to 0.50 m for the wall thickness [3.11].

- o Deck

All the concrete gravity platforms constructed to date have steel decks to minimize topside structural weight [3.12]. Some of the typical dimensions of these decks are given in Table 3.9.

3.3.3 Design Considerations

Design of a structure as complex as the CONDEEP concrete gravity platforms is extremely complicated. The variety of functional requirements, environmental loads, site geology, and structural systems accounts for this complexity. A flow chart of the design procedure is shown in Figure 3.7 [3.13].

The functional requirements as defined in Table 3.9 are drilling, production, treatment, compression, and storage. Each of these has slightly different requirements. For drilling, one must be able to provide a drill string from the surface, i.e., steel deck, to the field below the platform. In all CONDEEP designs, the drill string is located in one of the major support columns. Production, treatment, and compression require large amounts of machinery. These are located on the decks, in the columns, and in the caisson. The CONDEEP platforms use the cylindrical cells in the caisson for oil storage.

Environmental data are required to determine the loads that the structure must be designed to withstand. The ocean waves and currents

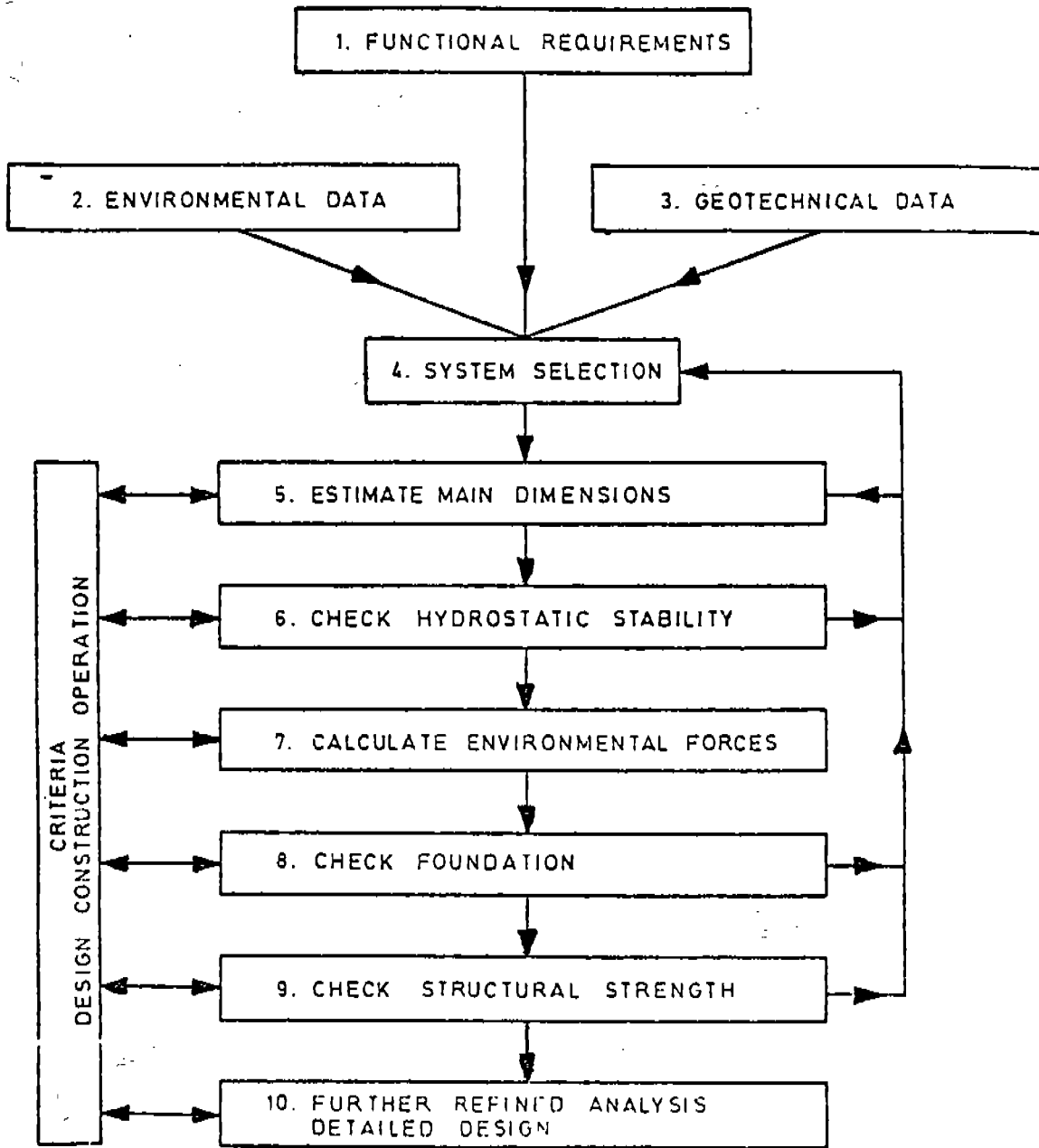

FIGURE 3.7 GENERAL DESIGN PROCEDURE
(FROM [3.13])

58

act as dynamic pressures on the submerged members of the structure, while the wind acts on the equipment and modules of the deck. These environmental loads make up the major contributions to the total overturning moment and transverse shear at the mudline of an offshore platform. The design values of the extreme loads are generally based on statistical data taking a recurrence period of 100 years for the ultimate limit state. The 100-year design waves for the CONDEEP platforms ranged from 29 to 32 meters, which is representative of the extreme weather in the North Sea region [3.9].

Geotechnical data are required to design the foundations of these gravity structures. The soil structure and strength were determined through site investigation. The site investigations may include a survey of the sea bottom topography, site geology, geophysical investigation; in situ determination of soil parameters by means of sounding, vane shear, and cone penetration tests; and sampling in bore holes with laboratory investigation of these samples [3.12]. Since this report deals primarily with floating structures, no details will be given concerning the required soil structure and strengths.

The design of a concrete gravity structure must incorporate the above requirements and information into a realistic and cost effective design. During preliminary design of a concrete platform, three types of requirements should be satisfied. They relate to [3.14]

1. the construction of the platform;
2. the platform as a floating body during installation;
3. the platform as a part of the production unit for oil and gas;

and are addressed below.

1. Temporary load conditions during construction have more influence on the dimensions of an offshore concrete structure than for an onshore structure. During the dry dock phase of construction, one must consider dead loads of partially completed structural elements, prestressing forces, and construction equipment loads. These loads are generally not critical for main dimensions, but may govern for certain local areas, for example, construction crane support pads [3.13].

Depending on the ballasting program, loads introduced can be governing for certain wall thicknesses. If an air cushion is applied to reduce the draft during flotation, the skirts will be exposed to lateral forces which may be larger than those experienced during service [3.13]. The weight of the structure may also be unevenly distributed, and the bottom section will be subjected to moments due to its own self-weight. These bending moments are generally large and should not be neglected during design of the bottom section [3.14].

Immersion for deck installation produces the maximum external compression on the columns, roof, and walls of the caisson. This means that the inner walls should be checked for compression to ensure that local stresses do not overload the concrete [3.13].

2. The requirements of the platform as a floating body were very important in the design and were critical to the concrete volume and price of the platform. A brief look at the CONDEEP platforms (Figure 3.6), indicates that large deck loads must be balanced by ballast near the bottom to maintain overall equilibrium. Otherwise, the platform would not be stable while floating. The CONDEEP design uses the large caisson as ballast during towing as well as storage during the production lifetime. This dual purpose design helps reduce the overall cost of the structures. Allowable draft during tow-out is also an important factor influencing the size of the caisson. The depth of water at the construction site and any shallow water through which the platform must travel have to be considered, as well as the shape of the caisson. A high caisson gives good stability and therefore a smaller volume. On the other hand, the wave forces may be high, requiring a larger foundation. The CONDEEP design with cell heights varying from 45 to 65 m attempted to optimize these various parameters.

The primary load on the floating platform is due to hydrostatic pressure. With concrete as the building material, it is sensible to utilize structural shapes which mainly give membrane compression. The cylindrical shape of the cells does this naturally and is also well suited for slip-forming. Domes at the upper and lower ends are also well suited for carrying distributed loads. However, edge stress discontinuities at the junction between the cells and domes are unavoidable. The resulting tensile force in the edge member is accounted for by prestressing the area. It is, however, far too expensive to prestress to achieve the membrane stress in the entire edge member. For this reason, moments and shears in the cylinder and dome near the edge must be accounted for. The shear in particular represents a problem. According to the contract, the design must satisfy the Norwegian Code NS 3473 [2.3] for concrete structures, which defines this shear force as a tensile stress problem. Therefore, the members had to be designed to have tensile strengths greater than the applied loads.

For a caisson of finite length, the displacement in the end caps under hydrostatic pressure will be less than that in the walls. Since the cells are connected, there must necessarily be tensile forces between the cells as a result of the hydrostatic pressure. These tensile forces were the cause of the cracks developed on Statfjord A [3.15]. This and earlier platforms had cylinders tangent to each other at the outside of the wall, as shown in Figure 3.8, and the star cells contained water under full external pressure. The caisson forces between the cells must have resultants directed from solid to solid. Since the wall between two solids

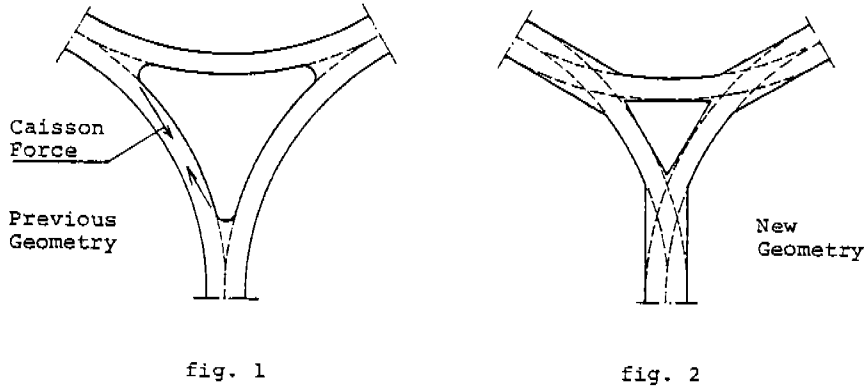

1 : 200

FIGURE 3.8 STAR CELL GEOMETRIES (FROM [3.14])

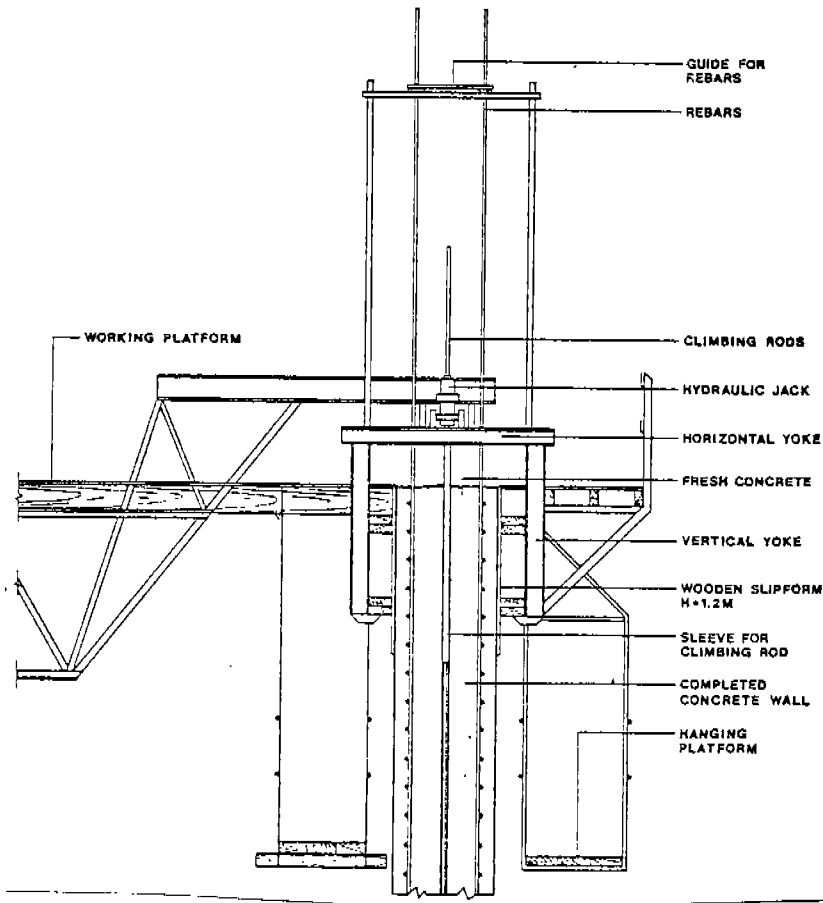

FIGURE 3.9 SLIP FORMING OF CELL WALLS (FROM [3.16])

is curved, the linear caisson force causes moments on the solid and at the middle of the wall. The caisson forces are larger for short cells than for long ones, and larger for many cells than for few. An alternative solution was chosen for Statfjord B, where the insides of the walls are tangent to each other, as shown in Figure 3.8. The walls in the triangular cell are kept empty. The total caisson force is somewhat larger for this geometry, but the directions of the caisson force and the normal resultant due to hydrostatic pressure coincide. The result is that the normal compressive resultant is reduced, but never becomes tensile, and the moment is almost zero. This wall configuration increases the volume of the concrete walls by 0.5 percent, but the displacing volume is also increased by approximately 7.5 percent. As for previous CONDEEPs, the walls of this configuration have the advantage of being able to carry the hydrostatic load even if one cell is damaged by an accident [3.14].

3. Among the requirements of the platform as a part of the production unit, the most important is to have a strong foundation able to resist forces from wind and waves during the lifetime of the structure, preferably without the need for maintenance. There are other functional requirements as well, such as housing of pumps, tubes and pipes, protecting risers and conductors, and storing of oil. The requirements to the platform as a foundation are:

- a. The soil pressure must not be excessive.
- b. Tension between the seabed and the platform is undesirable.
- c. The foundation must be big enough to transfer shear forces from waves without sliding, i.e., the shear stress must not exceed the shear capacity of the soil.

For good seabed conditions, requirement a is governing; for poor conditions, requirement b is governing [3.14]. For bottom-supported structures, foundation considerations influence the dimensions of the caisson and the skirt depth, and they are also decisive for the total weight (amount of ballast). The designer probably had to face the fact that very limited soil information was available at the stage of preliminary design. This means that conservative assumptions had been taken in the choice of design soil data. The base diameters of the CONDEEP platforms have ranged from 100 to 169 m (330 to 555 ft). The steel skirts penetrate into the soil between 1 and 2 m (3.3 and 6.6 ft).

The caisson dimensions are influenced by oil storage requirements. It is common practice to establish a prestressing of the caisson walls by keeping a lower pressure inside than outside the caisson. This procedure is especially favorable for oil storage caissons where the overpressure reduces the danger of leakage through the walls. The leakage will be further reduced by using the inner cells only for oil storage, thus establishing a barrier between the oil and sea water [3.13].

The in-service conditions are the controlling factors on the design of deck support towers. The lower tower diameter is governed by strength

and stiffness requirements. The main factors in the determination of the diameter are the wave height, the height of the tower, and the weight of the deck with equipment. The towers are tapered to reduce weight and to match the required strength. In addition to strength, fatigue must be considered in the design of the towers due to the dynamic wave loading. The towers must be designed for zero or negligible tension stresses, due to the combined effect of membrane stresses and local moments. This is especially important in the region near the connection between the tower and the deck. So far the oil companies have not been in favor of concepts with less than three towers, and some companies require four towers [3.13].

The dynamic response of the structure is one of the main features to be checked to evaluate the concept feasibility. Dynamic effects that may exclude a design are excessive movements or excessive dynamic magnification of the quasistatic forces and moments. Furthermore, fatigue, especially of the deck structure, should be checked with special view to the dynamic amplification of the numerous waves of moderate height, up to 65 percent of a 100-year wave. These sea states will have a peak frequency on the order of 0.05-0.20 Hz. Thus, the natural frequency of the structure should not be within this range [3.13]. For the CONDEEP platform, the first natural frequencies range from 0.25 to 0.50 Hz [3.12].

A CONDEEP-type platform is a large structure consisting of many structural elements. The only realistic approach to analyzing the structure is the use of a finite element model (FEM). The results are often verified by scale model tests of the entire structure as well as local regions of concern. Several models are used to obtain the required results. A coarse global model is used to obtain the basic strength requirement of the major structural elements. Resultant forces and displacement are taken from the global analysis and applied at the boundaries of local, fine-mesh models. The fine-mesh models are developed for regions of high stress gradients such as the upper and lower corners of the caisson cells, at the base of the main support column, at the connection between the columns and caisson, and at the connection between the columns and the deck [3.14].

3.3.4 Construction Procedure

All of the CONDEEP structures followed similar procedures in construction [3.10]. The lower portions of the structure---steel skirt, concrete skirt, lower domes, base slab, and first portion of the cell walls---were built in a dry dock. Mechanical installation in the base raft was performed while still in dry dock. The dock was then flooded, and with the aid of an air cushion the base raft was floated out and moored at a deep-water construction site. There the following main activities were carried out: slip-forming of cells, Figure 3.9; casting of upper domes; slip-forming of the towers; casting of transition ring beams at

the top of the towers; and ballast filling in the base raft. Mechanical outfitting in the shafts and cells was performed at the deep-water site after completion of the cell wall slip forming.

The steel decking, which was under concurrent construction in a dry dock, was installed by ballasting the structure so that only a small portion of the columns remained above the water. The deck was floated on barges and attached to the columns. The structure was then allowed to rise to towing depth. The final phase of the construction process was towing to the site and installation.

Table 3.10 shows the construction figures of the CONDEEP TCP2 platform. Each of the six platforms has slightly different design and construction features, depending on the location and site conditions of operation.

During construction of the Staffjord A CONDEEP platform, a problem was encountered with leakage in two of the storage cells. On September 10, 1976, two days after the maximum load was imposed on the cell walls due to installation of the steel deck, water leakage was discovered in cell no. 6 and subsequently in cell no. 2. Upon inspection, the damage in cell no. 6 was found to consist of a spalled area approximately 50 cm wide, 25 cm high, and 2 cm deep near the center of the juncture of cell no. 6 to cell no. 3. Two horizontal cracks ran across the lower part of the spalled area. The cracks, which appeared to dip steeply down into the wall, yielded a flow of some 15 m³/hr. In cell no. 2, a spalled area approximately 40 cm wide and 10 cm high was found near the center of the juncture of cell no. 2 to cell no. 1. One crack running across the area, again dipping steeply down into the wall, was estimated to yield 5-10 m³/hr of water [3.15].

Although the total leakage of approximately 25 m³/hr was very small compared to the available pumping capacity of 1,200 m³/hr, it was decided at this stage to regard the damage as potentially serious until further knowledge had been gained [3.15].

To obtain the required information, the following procedures were used [3.15].

1. Carry out a survey by underwater TV camera of all star cells adjoining cells no. 6 and no. 2.
2. Study the flow pattern by means of dye in the star cells adjoining the two leakages.

Extensive finite element analysis and model testing were also performed in an attempt to determine the source of the problem.

The conclusions of the structural investigations were [3.15]:

1. Cracking of the solid sections occurred due to a very local tensile stress zone which developed under the increased water pressure

64

TABLE 3.10 MAIN FIGURES ON THE CONSTRUCTION OF THE TCP2 PLATFORM
(FROM [3.11])

| | Form works (m ²) | Slipforming (m ²) | Reinforcement (tons) | Prestressing (tons) | Concrete (m ³) | Total Weight (tons) |
|------------------------------------|---------------------------------|----------------------------------|-------------------------|------------------------|-------------------------------|---------------------------|
| Steel Skirts | | | | | | 776 |
| Concrete Skirts | 4,350 | | 730 | | 1,230 | 3,805 |
| Lower Domes and Starcells | 6,000 | | 3,250 | | 11,250 | 31,375 |
| Cantilever Slab and Riser Supports | 3,070 | | 2,150 | 85 | 5,700 | 16,485 |
| Cell Walls | | 2,200 | 4,400 | | 28,300 | 75,150 |
| Upper Domes | 7,000 | | 1,000 | 100 | 3,900 | 10,850 |
| Columns | | 376 | 1,700 | 335 | 7,400 | 20,535 |
| Ballast Cylinder | | | | | 1,600 | 4,000 |
| Condensate Tank | | | | | 400 | 1,000 |
| TOTAL STRUCTURE | 20,420 | 2,576 | 13,230 | 520 | 59,780 | 163,976 |

3.33

486-328

65

65

during deck mating. Even a substantial increase of transverse reinforcement could not have prevented cracking of the concrete, but would have prevented crack propagation into the solid.

2. At deck mating, the main concrete membrane stresses in the cell walls are compressive both vertically and horizontally. Tensile stresses due to local moments and temperature differentials during curing or prestressing are of minor magnitude and do not fully explain why the crack deviated into the storage cell.

Based on the observations and the results from the analyses, a repair program was proposed which consisted of [3.15]:

- o Reducing the leakage by pumping a mixture of cement, asbestos fibers, and cinders into the star cells adjoining the cracked junctures, gradually clogging the entry into the cracks.
- o Sealing the cracks by injecting a low viscosity two-component epoxy.
- o Corrosion-protecting of any transverse rebars exposed by the cracks by filling the adjacent star cells with a gel consisting of fresh water, waterglass, and sodium bicarbonate.

The repair work had to be carried out under difficult conditions. The main problems were: the acting head of water (initially in excess of 125 m), the volume of the leakage (some 20-25 m³/hr), the lack of access to the star cells, and the difficult access inside the main cells [3.15].

After completion of the investigations, structural documentation, concrete repair program, and corrosion protection of any exposed reinforcement, the decision was taken to deeply submerge the platform a second time in order to mount the 800-ton living quarter modules on top of the deck by means of crane barges. Although the leakage had been completely stopped and full structural integrity had been documented by structural calculations, it was decided to perform the additional precaution of applying compressed air in the caisson cells [3.15].

In April 1977, the platform was submerged to a draft of 161 m with 4.2 atmospheres air pressure in the cells. No indications of any reopening of leakages were observed during this or any other subsequent operation, such as towing, installation, and offshore outfitting. Since the repair, the platform has been subjected to a number of heavy storms with wave heights approaching the design wave. These observations, together with the conclusions from the theoretical evaluations, support the conclusion that the structural integrity and serviceability of the platform have been effectively and permanently restored [3.15]. This problem was not observed in any of the other CONDEEP platforms.

3.3.5 Materials

It is generally accepted that good concrete is well suited to resist the severe exposure conditions of a marine environment. Adequate durability, however, can only be ensured through careful selection of materials, proper attention to a number of design aspects, and satisfactory workmanship [3.16].

In general terms, there is little controversy regarding the minimum requirements that must be satisfied for materials and workmanship to ensure adequate strength and durability for concrete in a marine environment. These are [3.17]:

- o constituent materials that satisfy chemical and physical requirements and are mutually compatible;
- o a minimum cube strength of 40 MPa;
- o a water/cement ratio less than 0.45 or 0.40;
- o adequate workability for proper placing and compacting to give high density and low permeability;
- o adequate cover to the steel and freedom from cracks, cold joints, and other imperfections;
- o adequate freeze-thaw resistance in the splash zone.

The strength requirements have varied from Grade C45* to C55 (characteristic 28-day cube strength of 45 to 55 MPa, respectively). The required and obtained strengths for several platforms are given in Table 3.11, together with the corresponding standard deviations. In all cases, the test results show a near normal distribution, with standard deviations ranging from 2.8 to 4.2 MPa. The latter values suggest very uniform production, bearing in mind that they cover periods of up to 2 years and include a number of variables brought about by adjustments to the mix design [3.17].

The main factor affecting the durability of the concrete is the quality and composition of the cement, assuming that any clearly undesirable materials such as alkaline-reactive-aggregate or chloride-contaminated materials are eliminated by standard control procedures according to general Codes of Practice. On the CONDEEP projects, ordinary portland cement (SP 30) from Norcem, Dalen, had been used up to 1978, when a special type of OPC (SP 30-4A) was developed, primarily for the

* C45, for example denotes a cube strength of 45 MPa.

TABLE 3.11 MIX PARTICULARS AND COMPRESSIVE STRENGTHS
FOR SEVERAL NORTH SEA CONCRETE PLATFORMS
(FROM [3.17])

| PLATFORM | MIX PARTICULARS | | 28 day COMPR. STRENGTH* (Mpa) | |
|-------------|-------------------------------|---------------|-------------------------------|-------------------------|
| | Cement Type/Typical Dosage | Admixtures | Specified | Obtained St. Dev. |
| BERYL A | Norcem SP 30/430 | Betokem LP | 45 | 56 (4.1) |
| BRENT B | Norcem SP 30/420 | Betokem LP | 45 | 54 (3.9) |
| BRENT D | Norcem SP 30/420 | Betokem LP | 45 | 53 (2.8) |
| | Norcem SP 30/440 | | 50 | 55 (2.9) |
| STATFJORD A | Norcem SP 30/420 | Betokem LP | 45 | 55 (4.2) |
| | Norcem SP 30/440 | Betokem LP | 50 | 55 (3.2) |
| STATFJORD B | SP 30 - 4A/360 | Betokem PA(B) | 50 | 65-70 |
| | | +R | 55 | --- |
| FRIGG TCP2 | SP 30/420 or 480 | Betokem LP+R | 45 ⁽¹⁾ | 56 ⁽¹⁾ (3.8) |
| | | Betokem LP | | |

*100-mm Cubes, Unless Marked

(1) 150-mm Cubes

3.36

486-328 (68)

(68)

specified high strength (C55) and low curing temperatures for Statfjord B. The data show that the SP 30-4A cement has low heat and sulphate-resistant properties which, in addition to its improved strength, makes it well suited for platform construction. The main characteristics for the Norcem cements are given in Table 3.12.

From a mix design point of view, the main objective is to produce high strength and high workability at low water/cement (w/c) ratio and low cement content. Water-reducing admixtures are essential aids to achieve this and are also required to retard the setting time of the concrete and to entrain air in the splash zone. From Table 3.11 it can be seen that the obtained strengths were close to the specified minimum, and consequently a high dosage of admixture had to be maintained for strength reasons. The resulting retarding effect was at times undesirable for production, particularly for the slip-forming of the shafts, where a compromise solution consisted of partly offsetting the retardation by heating the mixing water to 60°C [3.17].

The available results from Statfjord B show that for cement contents (SP 30-4A) of 360 kg per m³, the given admixtures, a w/c ratio of 0.42/0.43, and high workabilities (slump 150-100 mm), 28-day cube strengths of 65-70 MPa are obtained. The aggregates used are sand, 0-10 mm (mainly quartz), and coarse aggregate, 10-25 mm (mainly of granitic origin), from a large glaciofluvial deposit in Totlandsvik, Norway [3.17].

The specified minimum concrete cover of the principal reinforcement is generally 50-60 mm in the submerged zone and 60-70 mm in the splash zone. This cover is obtained by means of concrete spacer blocks and steel spacer guides on the slip-form. The main problems occur with splicing bars at construction joints, particularly the starter bars for vertical slip-formed walls. Due to overriding geometrical tolerance requirements, little or no allowance can be made for misaligned bars during the erection of the slip-forms. Consequently, areas of inadequate cover may occur. Any such deficient cover has been remedied by means of gunite or epoxy coatings. Tests on applied gunite have shown cube strengths of 50-60 MPa and bond strengths (direct tension) of 1-2 MPa at 28 days [3.17].

The corrosion hazards are particularly severe in the splash-zone, and some platforms have received an additional protective coating on the upper part of the shafts. This has consisted of a sprayed-on epoxy membrane in one or two layers of 0.3 mm or a 3-mm-thick coating of a thixotropic solvent free epoxy applied by trowel. The latter, which also has a certain impact strength, has been found to give bond strengths to the concrete of 1.6 to 2.5 MPa. The long-term performance remains to be seen, but visual observations have not yet revealed any bond failure or flaking [3.17].

The quality of the construction joints is a principal durability factor which received considerable attention during construction. Opinions

TABLE 3.12 TYPICAL PROPERTIES OF CEMENTS FROM NORCEM
(FROM [3.17])

| PROPERTY | NORCEM CEMENT | | |
|--|---------------|-------|------------|
| | SR | SP 30 | SP 30 - 4A |
| Fineness (Blaine) | 3200 | 3000 | 3100 |
| Setting Time (Initial) Min. | 220 | 120 | 140 |
| (Final) Min. | 250 | 180 | 200 |
| Compr. Strength MPa 7 Days | 36 | 37 | 35 |
| 28 Days | 46 | 46 | 54 |
| Mineral Composition % C ₂ S | 19 | 18 | 28 |
| C ₃ S | 57 | 55 | 50 |
| C ₃ A | 1 | 8 | 5.5 |
| C ₄ AF | 16 | 9 | 9 |

3.38

486-328

(70)

(70)

and test results differ regarding the best procedures for obtaining maximum bond. For horizontal joints, the procedure generally consists of laitance removal by means of high-pressure water jetting or sand blasting, sometimes in combination with a surface retarder sprayed on the joint immediately upon completion of concreting. Care is required not to cut too deeply into the hard concrete and dislodge or disturb the aggregate particles. The quality of the concrete being placed against the joint is important, and the tendency is to use an "oversanded" mix with a high workability in a thickness of 250 mm minimum to achieve efficient compaction with the poker vibrators. For vertical joints the emphasis is placed on removing any loose or porous concrete and shaping the joint so as to obtain a good mechanical key and easy access with the poker vibrator in the adjoining pour. Bonding agents are only used for special applications, such as anchor boxes, and need careful supervision with regard to surface preparation [3.17].

Protection of the prestressing cables and the anchorages was another paramount durability factor. The tall vertical cables with lengths up to 130 m required special grouting techniques to ensure complete filling of the entire length of the ducts. The chosen solution has consisted of a two-stage method with initial grouting from the bottom. Subsequent regrouting or topping-up was eliminated by a small stand pipe extension of the ducts. Careful mix design for high fluidity and pumpability at low w/c ratios is essential for a good result, together with detailed procedures for workmanship [3.17].

The main parameters governing the long-term performance of concrete in a marine environment are today well understood and defined in terms of requirements on material and workmanship. Experience has shown that the concrete required can be produced on site in large volumes and over long periods to exceptionally high and uniform standards, meeting the demands of stringent specifications and critical time schedules [3.17].

A range of tests have been carried out to determine several basic properties of a typical mix, and some of the results are given below [3.16]:

Modulus of elasticity: 2.8 ~ 3.0 x 10⁴ MPa

Poisson's ratio: 0.18 ~ 0.24

Creep: At a 25-MPa stress and 10 percent relative humidity (RH), 150-day creep strain was 1.2 percent. At 100 percent RH and 15-MPa stresses, the 150-day creep strain was 0.6 percent. Estimated ultimate creeps for the two above cases were 1.4 percent and 0.8 percent.

Shrinkage: Specimens were dried at 50 percent RH after 3 and 7 days of water curing. After 49 days of drying out, the shrinkage observed was 0.41 percent for the 3-day water cured specimens and 0.34 percent for the 7-day water cured specimens.

Air-void content: Air-entrained concrete, containing 200 mil per m³. Total air content 4-6 percent. Tests according to ASTM C 457 (modified point count method):

Spacing Factor: 0.24 mm
Specific Surface: 25 mm⁻¹

All concrete was vibrated by means of high frequency (12,000 revs/min) poker vibrators. Generally, 70-mm-diameter vibrators were used, but occasionally 40-mm pokers were required in the most congested areas. Particular emphasis has been placed on proper use of the vibrators and thorough revibration of each lift in conjunction with the placing of the subsequent layer [3.16].

Curing of the concrete was done by water spray (fresh water) or the application of a curing compound. Water curing was inconvenient in certain sections as the work progresses, due to other activities such as posttensioning and grouting taking place below the spray [3.16].

3.3.6 Experience

The size of concrete gravity platforms immediately imposes practical restrictions on the selection of areas and elements to be inspected on the structure. As an example, the CONDEEP Statfjord A-platform has an external surface area on the concrete substructure of approximately 50,000 m². Inspection is typically carried out by the following means [3.18]:

Atmospheric Zone:

- o visual inspection from removeable working platforms, cages, boats etc.

Submerged Zone:

- o visual inspection by means of
 1. remote controlled television equipment
 2. divers
 3. submarine
- o instrumentation

It seems fair to assume that all major damage to concrete structures will be visible before it reaches an extent jeopardizing the integrity of the structure. Examples are [3.18]:

- o overloading - results in excessive cracking
- o rebar corrosion - surface staining, cracking and spalling

- o deterioration ~ loose concrete vulnerable to scraping, etc.
- o sulphate attack ~ crumbling of the surface.

Actual inspections revealed the following [3.18]:

- o Inspection of the caisson roof and inside of drilling shafts has been hampered by debris and drilling mud.
- o The splash zone and upper part of the shafts have been covered by soft marine growth.
- o Embedded steel plate inserts and appurtenances are corroded, but seemingly not seriously impaired.
- o Steel appurtenances are in certain cases incomplete.
- o The concrete surfaces showed an excellent condition without any harmful cracks or defects.
- o Possible cracks have a tendency to heal by sedimentation of magnesium and chalk compounds.

Minor damage has been observed on several platforms, mainly caused by external impact. Examples of such cases are [3.18]:

- o In one case a 36-in. drain caisson was dropped on the concrete cell roof and locally spalled off the concrete to a maximum depth of about 10 cm.
- o A riser, improperly fixed, rubbed the shaft wall and caused minor abrasion.
- o On several occasions, accidental ship impacts have resulted in score marks of a few cm depth.
- o In one case the formwork, which was made of plain concrete and which was not removed, eventually spalled off after a few years of splash-zone exposure. This spalling had no structural significance and did not reduce the quality of the structure.
- o In one case, 1-2 cm of concrete spalled off during a fire inside one of the shafts.

The majority of these cases have been repaired, even if a study of their possible consequences might have concluded them to be completely harmless. In general, the influence of minor defects seems to be overestimated by personnel not skilled in concrete structural design. In certain cases, large volumes of reports and investigations have been prepared to study defects obviously lacking any practical significance [3.18].

To obtain an understanding of the performance of the offshore concrete structures, a full-scale measurement project was carried out to monitor their behavior in service. The principal purpose of this project was to collect data from the Brent B CONDEEP platform which could be used [3.18]:

- o to verify the soundness of the design principles currently in use for concrete gravity structures in the North Sea;
- o to improve the quality and accuracy of the design methods used for such structures;
- o to predict possible damages of this and other platforms of similar design.

The design of the shafts on the platform was based on considerations of the ultimate strength, fatigue strength, and serviceability requirements. As it turned out, the serviceability requirements had the most significant influence on the design. The bending moments at the bases of the shafts were estimated for a 100-year design condition, based on moments calculated from observed strains and on extrapolation of the wave condition. Bearing in mind the uncertainties in this procedure, it was concluded that the measurements showed that at the design sea state the shafts are expected to experience load effects of the same or slightly smaller magnitude than assumed in the design. The design capacity, however, is more than twice the assumed load effect. Hence, the safety of these concrete sections is considerably higher than required by the design code. The measurements indicated that the shafts will experience only compressive stresses, except for possible small stresses in tension due to local bending at the base of the shafts. The cyclic stress variation in the reinforcement will, therefore, be limited and well below the fatigue stress endurance [3.18].

A general conclusion of the project is that there is no indication in the measurements or the analyses that the platform will perform less satisfactorily than anticipated at the design stage. This conclusion is valid for the foundation soil, as well as for the structure itself. There are strong indications that the design to ensure the durability, e.g., related to rebar corrosion, is a conservative one. Recent research has confirmed that the loads experienced during the phases of construction and installation exceed service load conditions or the design has considerable reserve strength. For this reason, it is likely that in the future the amount of in-service inspection of concrete structures may be reduced, that maintenance will be found unnecessary, and that repairs will be restricted to accidental damage such as that associated with ship impacts [3.18].

3.4 Concrete Ships Built During World War I

This section briefly describes the shipbuilding program of World War I and the experience of four of the vessels constructed in the U.S. and Great Britain.



Major losses in allied merchant shipping due to submarine action and the resultant increased demand for replacement ships caused a shortage of steel plate for military use. Great Britain and the U.S. turned to reinforced concrete as an alternative hull material, and emergency shipbuilding programs were established [3.7]. The development, design, construction, and operation qualities of many large vessels built in several countries during the war are described in references 3.19-3.22. Most of the big ships came from the United States, including the biggest built up to that time, the 6340-ton *Selma*. In Great Britain a few oceangoing vessels were built, and the 1150-ton *Armistice* was afloat until 1969. Shipyards were set up in many parts of the United Kingdom to build 1000-ton capacity barges, and one such barge, the *Creteravine*, built in 1919 in Gloucester, is reported still afloat in a Norwegian fjord.

About 85,000 tons of ships were built in this period, not counting several hundred barges, lighters, pontoons, and a few floating docks. Reference 3.7 reports that about 69,000 tons was constructed in the U.S., with the remaining 15,000 tons built in Great Britain and the Scandinavian countries. A glut of merchant shipping followed the end of hostilities, and the concrete shipbuilding program eventually stopped. No new concrete vessels were built between 1922 and World War II.

A brief description of four of the vessels follows:

Name: *Selma*
Country: United States
Built: 1919
Size: 6340 ton, 130 m (434 ft) long
Material: Cast, reinforced concrete
Disposition: Scuttled in shallow water in Galveston Bay after a few years of service.
Experience: The expanded shale aggregate concrete in the 100-mm (4-in.) hull was examined in 1953. From reference 3.23:

Specimens were taken in the band, which was alternately exposed to seawater and salt air by action of wind and tides. Specimens from the compartment ribs had been exposed to salt air only. The concrete was in excellent condition in both of these areas. The report [3.23] further states that some of the hull concrete was chipped out to a depth of 1/4 in., and at this depth the concrete appeared to be dry and there was no discoloration from absorbed water. An examination of the interior of the hull showed that the concrete was in very good condition, and no cracks were visible. The report finds the reinforcing steel in excellent condition, with no pitting of the bars, and concludes that the slight coating of rust could well have been

on the bars when they were placed. The report also points out that in many places there was only 5/8 in. of concrete over the reinforcing steel.

Name: *Armistice*
Country: Great Britain
Built: 1919
Size: 1150 ton, 62.5 m (205 ft) long
Material: Reinforced concrete
Disposition: Operated for many years and scuttled in 1969.
Experience: *Armistice* was surveyed in 1968; reported were a badly spalled outer hull and internal frames almost devoid of concrete, with the steel corroded [3.7]. Fougner [3.19] was critical of the *Armistice* and said: "The concrete used was not rich enough...the additional cost of cement is a trifling matter compared with the total cost of a seagoing ship." Fougner suggested a mix no leaner than 1:2-1/2, using well-graded aggregates up to 1/2-in. maximum. Morgan [3.7] reports that the plasticity and watertightness necessary in concrete ships can be assured only by reducing the amount of aggregate, especially the coarse type, considerably beyond what laboratory investigation may often indicate. Some of these concrete ships built during World War I with Fougner guidance are still afloat, whereas the concrete in *Armistice* had severely deteriorated, both inside and outside.

Name: *Peralta*
Country: United States
Built: 1921
Size: 6380 ton
Material: Reinforced concrete
Disposition: Serving, along with other ships of the World War I and II periods, as part of the Powell River breakwater in British Columbia.
Experience: Reported in good condition.

Name: *Cape Fear*
Country: United States
Built: 1919
Size: 2795 ton
Material: Reinforced concrete
Experience: Sank in 1920 after a collision at sea. A survivor reported, "She shattered like a teacup when hit." [3.7, 3.22]

3.5 Other Fixed Structures

3.5.1 Ekofisk One

This oil storage facility was the first fixed-gravity structure designed and constructed for the North Sea environment. It was installed in June 1973 at a 70-m water depth and provided the impetus for the subsequent structures listed in Table 2.1.

The original concept was to develop an oil storage and production facility to allow for continued production during periods of severe weather when tankers could not be moored. Because of the severe weather conditions and the location, 270 km (170 miles) from Stavanger, Norway, in situ construction was ruled out. Following competitive design, in which both steel and concrete structures were proposed, a posttensioned concrete structure, built inland, was selected on cost and operational grounds [3.24].

The tank was designed by a French company, C. G. Doris, and has the shape of a square with rounded corners, Figure 3.10. The crude oil, stored in nine compartments in the center of the tank, is surrounded by a perforated breakwater designed to reduce the wave loading on the interior storage compartments. The base of the structure consists of a concrete mat with a skirt and ribs designed to penetrate the sandy soil upon installation. The structure consists of a combination of precast and cast-in-place concrete with standard and posttensioned reinforcement. Reference 3.24 gives a good description of the construction procedures used.

The unique feature of this design is the perforated breakwater. The 100-year design wave, a 24-m (79-ft) high wave, will result in a pressure of 60 tons/m² (12,300 psf). The breakwater is designed such that a portion of the wave's energy is reflected and the remainder goes through the perforations. A large portion of the remaining energy is dissipated in the large fluid mass located between the breakwater and the reservoir wall. The breakwater consists of a series of precast concrete spools. To withstand the constant water movement and potential cavitation and erosion problems, the spools were precast in steel forms to obtain a smooth, dense finish. With the low water-cement ratio and rich concrete mix, strengths of 62 to 69 MPa (9,000 to 10,000 psi) with the desired erosion resistance were obtained. The spools were then placed on circumferential rings and cast in place, with concrete used to tie the system together. Both passive and posttensioned reinforcements were used in the breakwater. Figure 3.11 shows the structure during the construction phase. The breakwater and oil storage systems can be easily recognized.

Extensive instrumentation was installed during construction to determine the response of the structure due to environmental loads [3.25]. The instrumentation was designed to measure the oceanographic and meteorologic data as well as the load and response data. In November 1973, six months after installation, Ekofisk One survived a major storm with waves up to 90 percent of the 100-year design wave. The measured response of structure was well within the design limits. The analytical results and actual measurements compare favorably throughout the entire installation and operational phases of the structure. The overall performance of Ekofisk One indicated that the use of reinforced concrete structures in the severe North Sea environment is very practical.

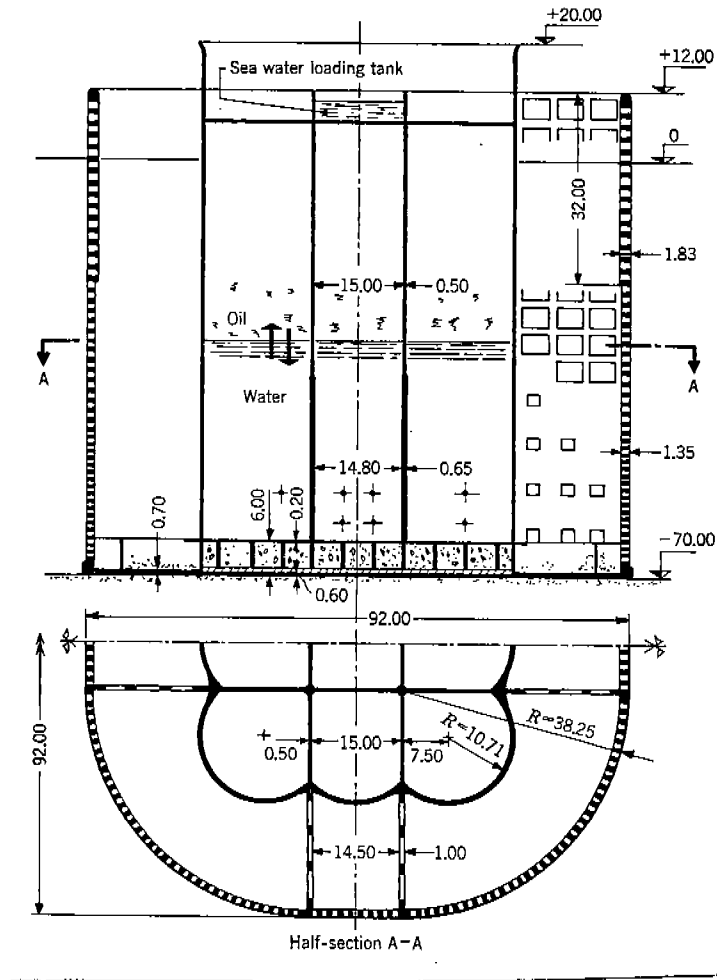

FIGURE 3.10 VERTICAL CROSS-SECTION AND HORIZONTAL HALF-SECTION OF THE EKOFISK ONE FACILITY (FROM [3.24])

2a

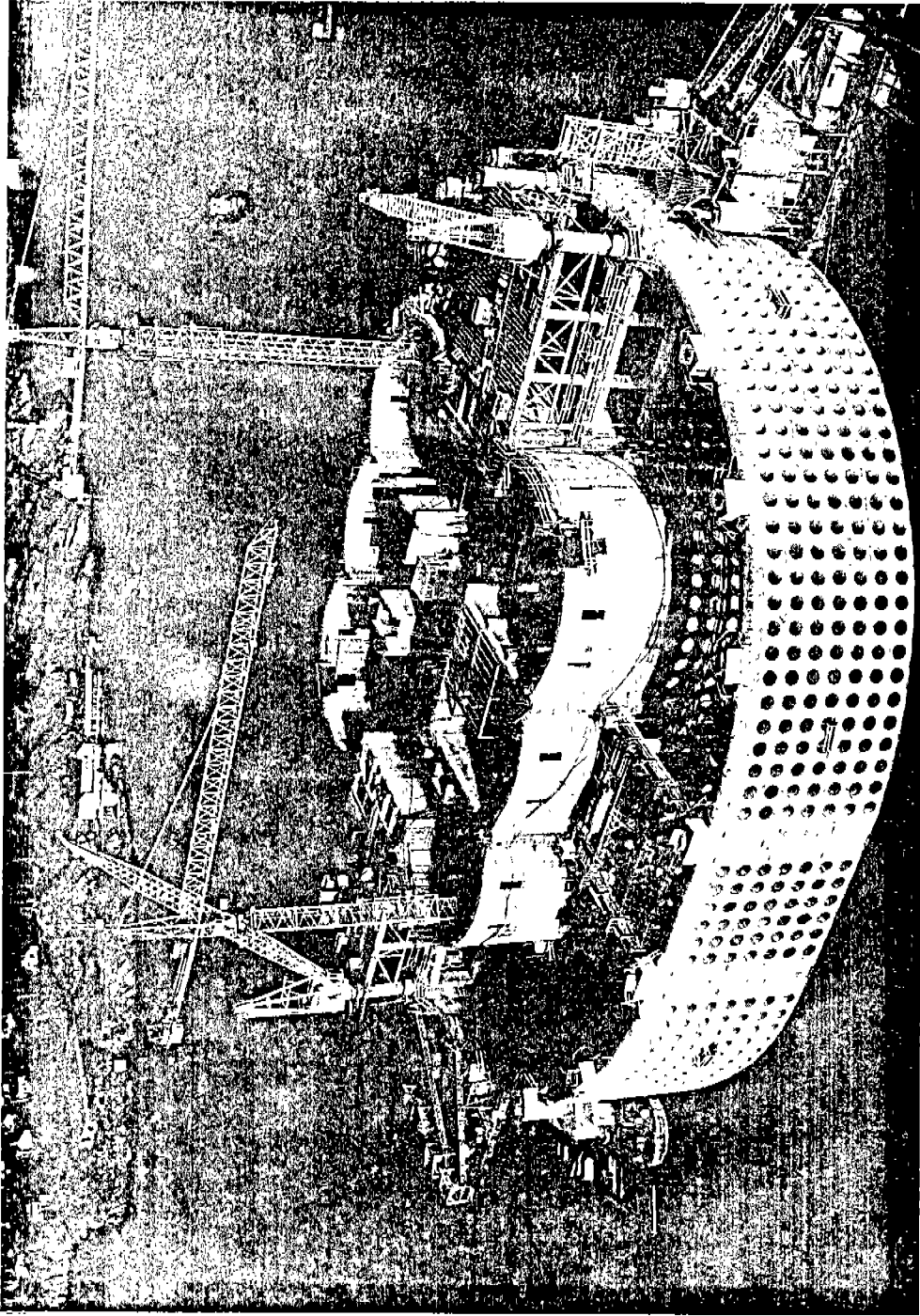

FIGURE 3.11 EKOFISK OIL STORAGE CAISSON UNDER CONSTRUCTION (FROM [3.24])

3.5.2 Gulf of Mexico Gravity Structures

Reference 1.4 reports that Belden Concrete Products and Marine Concrete Structures, New Orleans, and Ingraham Concrete Structures, Slidell, Louisiana, have built over 500 reinforced concrete hulls of various sizes for use in the Gulf of Mexico since 1955. These barges serve as bases for a variety of uses such as compressor stations, production facilities, and oil separation and storage. However, in the United States, particularly in the Gulf, the use of concrete gravity offshore structures is limited because the preference is for regular pile-driven steel platforms. Marine Concrete Structures in Louisiana has been active in the design and construction of a number of gravity type installations for use in coastal areas and inland waters of the Gulf.

One structure that has been installed is the ARCO oil production platform, the first concrete gravity structure in U.S. offshore waters. Figure 3.12 shows an elevation view of this platform, and the design data are given below.

| | |
|--------------------------|---|
| Base Structure: | 23.5 m x 34.2 m (77 ft x 112 ft) |
| Deck Elevation: | 11.9 m (39 ft) |
| Deck Area: | 24.4 m x 24.4 m (80 ft x 80 ft) |
| Design Wave: | 100-year storm |
| Live Load Design: | 1000 psf for deck area 500 psf for beams and columns |
| Oil Storage Capacity: | 7800 bbl |
| Production Capacity Oil: | 5,200 BPD |
| Natural Gas: | 10,000 MCFD |

These platforms are designed for the relatively shallow depths of the Gulf of Mexico as compared with the much deeper waters of the North Sea.

3.5.3 Permanently Moored Barges

3.5.3.1 ARCO LPG Floating Facility

Designed by ABAM Engineers, Inc., and constructed by Concrete Technology Corporation of Tacoma, Washington, this moored barge structure was the first large prestressed concrete offshore facility for liquefied petroleum gas (LPG). Overall dimensions are:

| | |
|----------------|--------------------|
| Length overall | - 140.5 m (461 ft) |
| Beam | - 41.5 m (136 ft) |
| Depth | - 17.2 m (56.5 ft) |

(80)

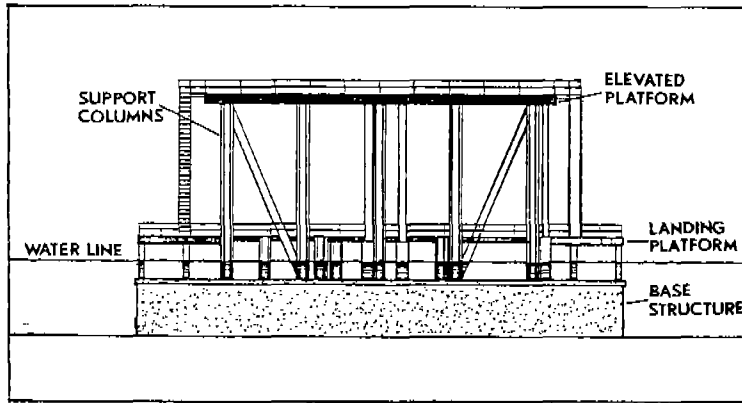

FIGURE 3.12 CONCRETE GRAVITY PLATFORM FOR GULF OF MEXICO
(FROM [3.26])

References 3.27 and 3.28 contain detailed descriptions of the design and construction of this moored facility. Design criteria were based on requirements established by the American Bureau of Shipping. The design was based on maximum allowable stress and load factors for the delivery voyage (U.S. West Coast to the Java Sea), normal service, and 100-year storm conditions given in Table 3.13. Construction loads were also analyzed to ensure hull integrity during all phases of the construction.

TABLE 3.13 ASSUMED WAVE HEIGHTS AND STRESS LIMITS, ARCO FACILITY
(FROM [3.28])

| <u>Sea Conditions</u> | <u>Delivery Voyage</u> | <u>Normal Service</u> | <u>100-Year Storm</u> |
|------------------------|---|---|-----------------------|
| Wave height | 23 ft (7 m) | 11 ft (3.3 m) | 27 ft (8.2 m) |
| Maximum allowed stress | zero tension 0.45 f'_c compression | zero tension 0.45 f'_c compression | - |
| Cracking load factor | 1.65 | 2.00 | - |
| Ultimate load factors: | | | |
| Required | 2.0 | 2.6 | 1.3 |
| Actual | 2.1 | 3.5 | 2.0 |

*Note that f'_c is the symbol for cylinder compression strength in psi.

A cross section of the hull is shown in Figure 3.13. The bottom consists of three cylindrical barrel shells designed to resist the 14.6-ton/m² (3,000-psf) hydrostatic pressure. The 375,000-barrel storage capacity is supplied by 12 cylindrical steel tanks, 11.6 m (38 ft) in diameter and 51.2 m (168 ft) long, with hemispherical ends. Six tanks are located below and six tanks above deck.

81

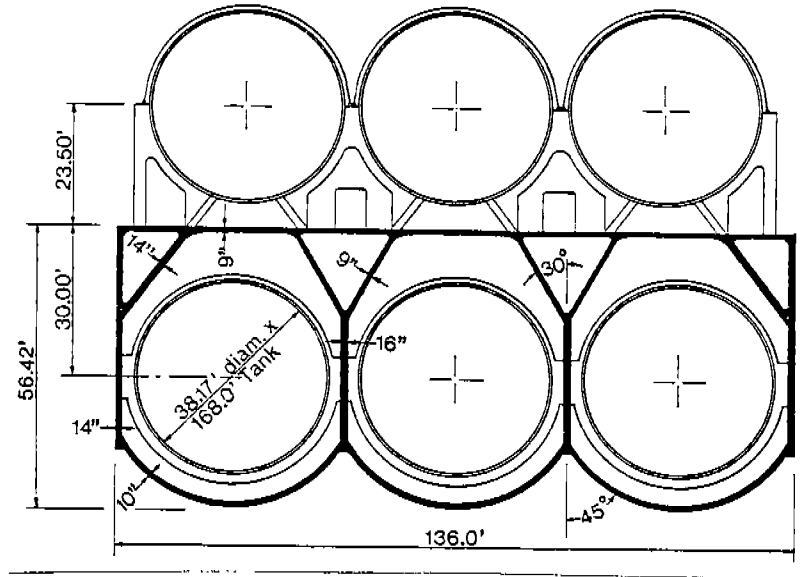

FIGURE 3.13 MIDSHIP SECTION, 65,000-TON CONCRETE LPG FACILITY (FROM [3.28])

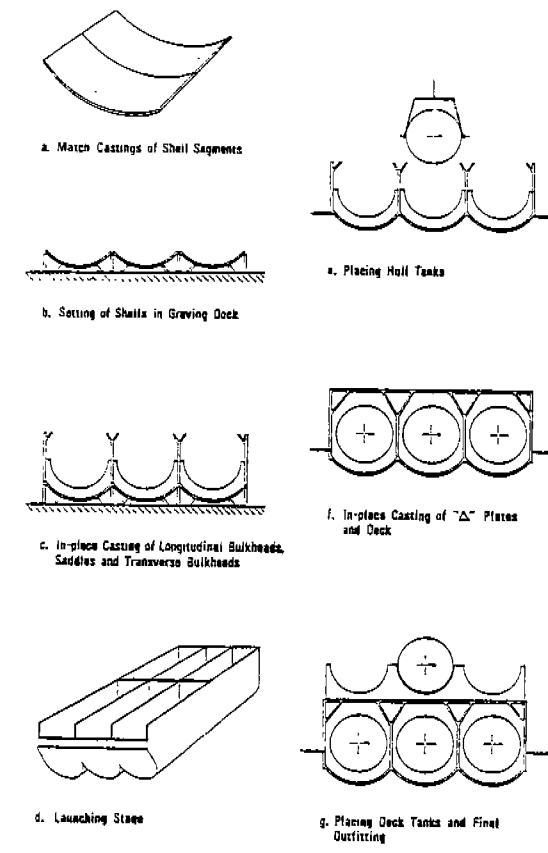

FIGURE 3.14 HULL CONSTRUCTION SCHEME OF ARCO LPG BARGE (FROM [3.28])



The general hull construction procedure is shown in Figure 3.14. The hull bottom is made of precast concrete shells which were match-cast in steel forms (a). The shells have standard reinforcement as well as ducts for longitudinal and transverse tendons. Epoxy adhesive was used on all joints to ensure watertightness. Following assembly of the bottom shells in the graving dock (b), the longitudinal bulkheads and vertical sides were cast in place (c). The hull was then launched (d), and the lower six tanks installed (e). The upper portion of the hull was constructed using cast-in-place concrete with movable steel forms (f). Finally, the upper tanks and mechanical equipment were installed (g). Quality control during the entire construction phase was rigorous. The average 28-day compressive strength of 66 MPa (9800 psi) was obtained. Performance of the LPG facility during towing and operational conditions has proved satisfactory to date [3.28].

Anderson [3.28] cites the following advantages for using prestressed concrete for barges and floating structures:

- o Lower initial construction cost;
- o Superior durability in sea water environment;
- o Ductile behavior when severely overloaded;
- o Freedom from damage under fatigue-type loads;
- o Excellent properties at extremely low (cryogenic) temperatures;
- o Superior behavior when exposed to fire;
- o Ease of repair when damaged by collision, etc.;
- o Dry-docking at regular intervals for inspection, repair, and maintenance not necessary.

3.5.3.2 Japanese Barge Programs

Several organizations in Japan are involved in the development of barges for a variety of applications. Mitsui Engineering and Shipbuilding Co., Ltd. (MES), and Taisei Corporation have performed extensive analytical studies as well as model and prototype testing.

The MES design is a hybrid-steel prestressed concrete design [3.29]. The bottom and side plates are prestressed concrete. The internal stiffeners and upper deck plate are constructed of steel, which has the advantage of reducing hull weight. Testing was performed on a composite prestressed concrete and steel beam as well as a prototype barge designed to Nippon Kaiji Kijokai specifications [2.14], and results indicate responses within design limits [3.30].

The Taisei concrete barge is similar in design to the MES system, consisting of concrete bottom and sides with a steel upper deck [3.31]. Three different barges have been developed to date:

- (1) G-Boat 500 -- 37 m x 9 m x 3.1 m (121 ft x 30 ft x 10 ft). A 500 deadweight ton prestressed concrete barge used as a floating berth at Honshu-Shikoku Bridge construction site.
- (2) JSF-01 -- 24 m x 6 m x 3 m (79 ft x 20 ft x 10 ft). Prestressed concrete floating berth at the Japanese Oceanic Science and Technology Center.
- (3) Tokyo University of Fisheries' Pontoon -- 10 m x 3 m x 1.7 m (33 ft x 10 ft x 6 ft).

3.6 Harbor and Coastal Structures

In sheer numbers HSC type of structure represents the largest use of concrete in the marine environment. Application includes buoys, caissons for floating bridges, docks, ship locks, production facilities, and breakwaters. In the vast majority of these structures, the additional weight involved in the use of concrete as the primary construction material is an advantage rather than a hindrance, as is the case for concrete ships. Low maintenance cost is a primary consideration in the decision to build these types of concrete facilities.

3.6.1 Harbors and Docks

A number of concrete docks and harbor facilities have been designed and constructed. One recent example is a prestressed concrete floating dock for the harbor of Genoa, Italy. The main geometric characteristics are [3.32]:

| | | |
|------------------|---------------------|------------|
| Length overall | 350.5 m | (1,150 ft) |
| Width overall | 79.3 m | (260 ft) |
| Width internal | 65.7 m | (216 ft) |
| Lifting capacity | 100,000 metric tons | |

The structure consists of concrete slabs separated by steel tubes in a tetrahedral arrangement (Figure 3.15). The upper nodes of the tubes are connected by steel girders, while the lower nodes are connected by prestressed concrete beams. The prestressing tendons are evenly distributed inside the slabs in both orthogonal directions. A finite element analysis of the dock was performed for a wide variety of loading conditions, and Reference 3.2 contains a detailed description of the analysis procedure and results.

A second example is the East Tomakomai Industrial Development Project where construction began in 1976. The project consists of a public wharf, a berthing facility for large petroleum tankers, a breakwater and waterway, and a mooring basin [3.33]. The breakwater consists of a series

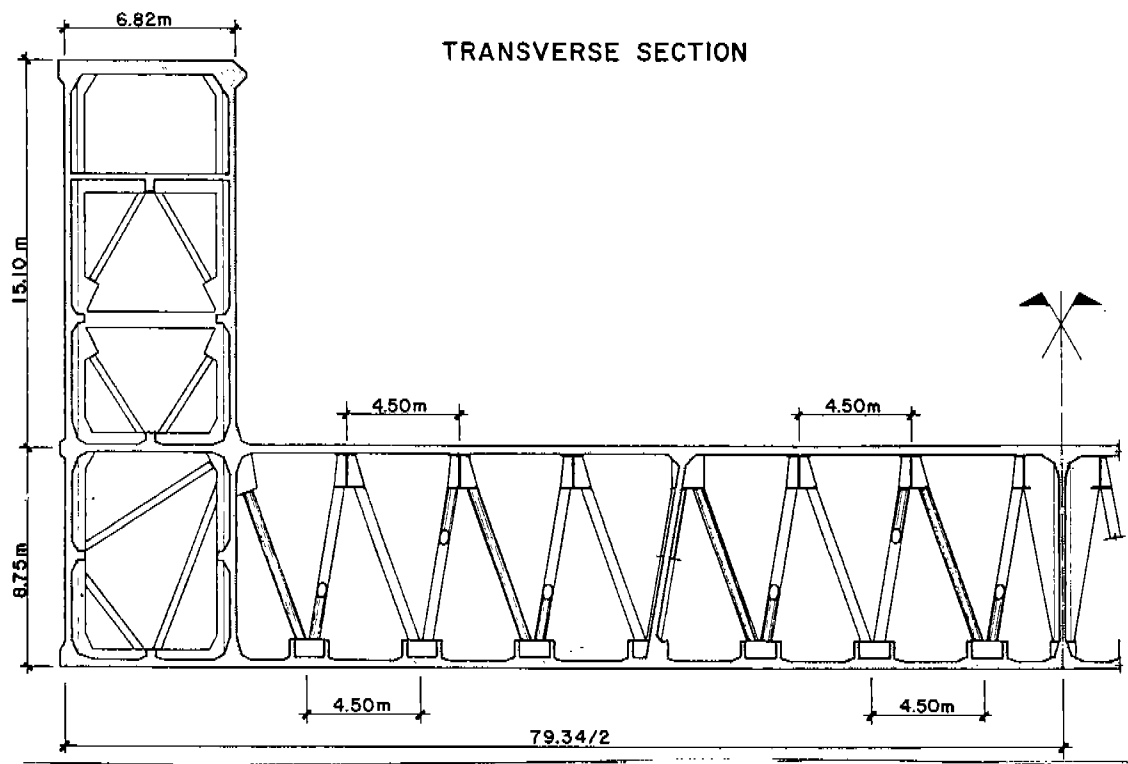
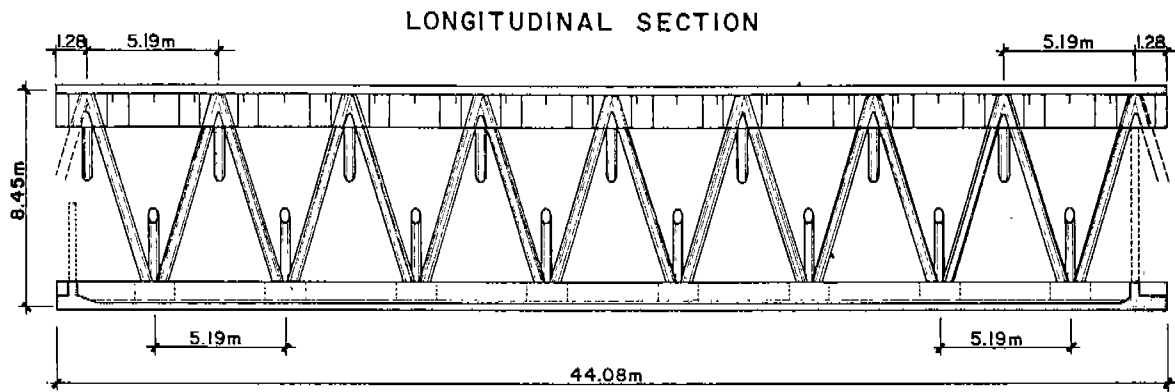

FIGURE 3.15 LONGITUDINAL AND TRANSVERSE SECTIONS
OF GENOA'S FLOATING DOCK (FROM [3.32])

of concrete caissons 26 m long, 21 m wide, and 18 m high resting on a steel H-beam mattress and rubblestone. After being filled with sand, the caissons were capped with concrete to form an integral unit. The total breakwater length was 9,930 m, which represented a significant portion of the construction. The precast caissons, weighing up to 3,000 tons, are examples of the large units which can be built for either harbor or barge structures.

The offshore coal loading terminal for 120,000-dwt ships at Hay Point, Australia, used similar construction techniques [3.34]. The ten prestressed concrete caissons used were constructed using precast wall panels with in situ joints, floors, and roofs. Three large, 37.5-m x 46-m x 8.5-m, caissons were used to support the steel deck of the berth, and seven smaller, 17.5-m x 17.5-m x 8.5-m, caissons were used to support a conveyor roadway and two mooring dolphins. An average prestressing of 5 MPa was used throughout the structure, with the ducts running along the centerline of the slabs. Several minor problems were encountered during construction of the caissons that resulted from cracking along the lines of the cable ducts. They were repaired using thin coats of epoxy resin. After the caissons were completed, the cast-in-place reinforced concrete columns, 12 m square by 18.5 m high, were constructed by slip-forming. The steel deck structure was then installed, and the assemblies were ready for towing to the site [3.34].

3.6.2 Bridges

Floating concrete bridges are representative of the type of structure required to withstand dynamic wave loading conditions and resist long-term corrosion problems. Three examples are multi-pontoon bridges constructed in 1939, 1955, and 1962 for the state of Washington. The service record of the first two bridges was good, while the third, the Hood Canal Bridge, failed during a storm in 1979. The following discussion addresses several points in the failed bridge's design, construction, and service history.

The bridge was 2,396 m (7,860 ft) long, which included about 253 m (830 ft) of fixed approach spans, a 1,972-m (6,470-ft) floating portion, and 171 m (560 ft) of transition spans between the fixed and floating portions. The floating portion of the Hood Canal Bridge consisted of 25 reinforced, prestressed concrete pontoons supporting a reinforced concrete roadway viaduct. The pontoons were connected rigidly together to form a continuous floating hull with a gap at the navigation channel. The train of concrete pontoons was linked with steel truss transition spans. The 25 concrete pontoons include: [3.35]

- 2 - Auxiliary pontoons for anchoring prestressing tendons
- 2 - Cross pontoons (transverse to roadway) which support the canal end of the transition spans

- 11 - Standard 110-m (360-ft) long pontoons
- 2 - Flare pontoons (transition pontoons between standard and flanking pontoons)
- 4 - Flanking pontoons at the navigation channel
- 4 - Draw pontoons at the navigation channel

A standard 110-m (360-ft) long pontoon is 15.0 m (50 ft) wide; it is 4.34 m (14 ft 3 in.) deep along the longitudinal centerline and slopes downward in each direction to 4.27 m (14 ft) deep along the exterior faces. The top slab of the pontoon is 18 mm (7 in.) thick while the bottom slab and exterior walls are 23 mm (9 in.) thick. The pontoons are cellular in construction, with three longitudinal interior walls about 3.65 m (12 ft) apart and transverse walls every 4.57 m (15 ft). Every second transverse wall is a solid wall; intermediate transverse walls and all longitudinal interior walls have access openings. The wall arrangement thus produces watertight cells which measure the full 15-m (50-ft) width of the pontoon by 9.1 m (30 ft) longitudinally. A 0.61 m (2 ft) by 1.22 m (4 ft) manhole, or hatch, in the top slab is provided for access into each watertight cell. Hinged steel covers are provided for each hatch. The pontoon walls and top and bottom slabs are reinforced with conventional deformed bars. Each pontoon is also prestressed internally with 43 longitudinal tendons, each consisting of eight 3/8-in.-diameter strands. Of the 43 tendons, five are located in each of the exterior walls, three in each of the three interior longitudinal walls, and 24 in the bottom slab. The designed prestress force provided by the 43 tendons totaled 4,403 kips [3.35].

A major modification was made during construction to strengthen the complete bridge, including the addition of 24 longitudinal prestressing tendons running full length (in segments) through the floating sections of the bridge, Figure 3.16. The purpose of these added tendons was to increase the longitudinal bending capacity of the full floating sections. Twelve of the added prestressing tendons were installed just under the top slab, and the other twelve tendons, just above the bottom slab. Each of the tendons consisted of forty 1/4-in.-diameter wires. Special anchorages for these tendons were constructed inside the pontoons. These added tendons were exposed within the pontoon cells over much of their length [3.35].

Each butt joint between two pontoons was bolted together with eighty 1-1/2-in.-diameter bolts. The original design specified that the bolts conform to ASTM Designation A-325-53T. The later design review resulted in changing 34 of these bolts at each joint to alloy steel bolts conforming to ASTM Designation A-192-58T, Grade B7. In addition to changing these bolts, the design modification further required that the bolted joints be grouted with an epoxy grout [3.35].

The pontoons were anchored transversely by 42 steel cables running to concrete gravity anchors resting on the canal bottom in water depths up to 104 m (340 feet) [3.35].

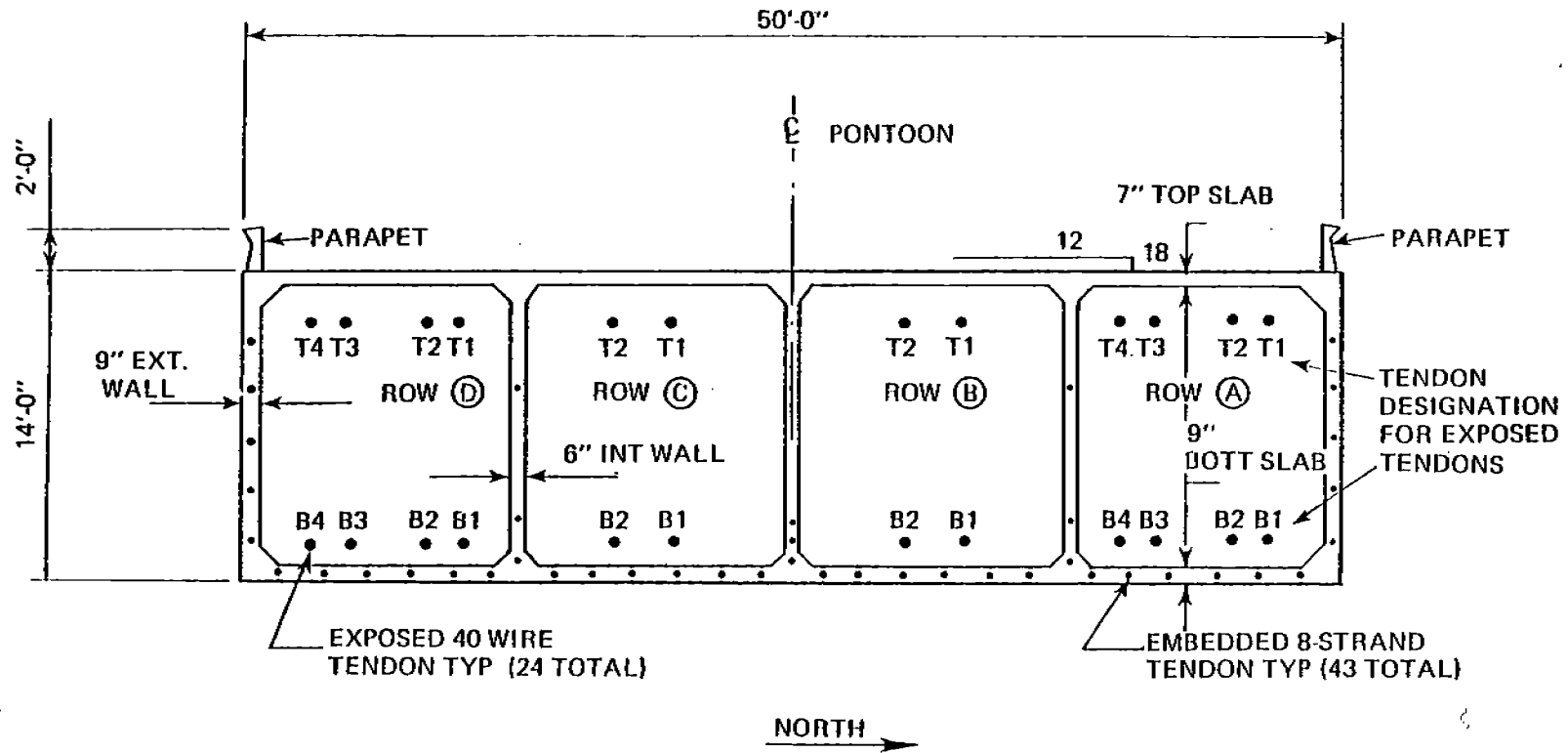

FIGURE 3.16 TYPICAL PONTOON SECTION (FROM [3.35])

3.56

486-328

88

(2)
(X)

Each anchor is a hollow concrete box, 12.2 x 5.8 x 4.8 m (40 x 19 x 15.75 ft), high with an immersed weight, when ballasted, of approximately 530 tons. The anchor cables are 1-3/4-in.-diameter bridge strand. The center point of each cable passed around a cable yoke at the anchor with both ends socketed and connected to anchorage units in the pontoons. Cable tension could be adjusted at these anchorages with a design pretension of 60 kips per cable [3.35].

After construction of the Hood Canal Bridge, a research program on the response of floating bridges was carried out from 1966 to 1972 by the University of Washington [3.36]. Problems with the maintenance of the prestressing tendons were noted. Since these tendons were open to the air over the majority of their length, they were susceptible to corrosion. Twenty of the tendons had been replaced, while individual wires on the other tendons had been mechanically spliced together. At the time of the bridge failure, February 13, 1979, records show that three tendons were missing, two in the west section and one in the east section. In addition to the three missing tendons, two tendons had been slacked to approximately 50 percent of their design load due to problems with the sockets. The three missing tendons were to have been replaced soon [3.35].

The anchors and anchor cables were reported to be in good condition before the failure. The cables were protected against corrosion by an impressed-current cathodic protection system, which appears to have performed satisfactorily [3.35].

Each standard pontoon had 13 access hatches. The covers for these hatches were not watertight. On the west section of the bridge, 12 of the 13 covers were located on the south side of the bridge and were hinged to open from the south. Only one of the 13 covers on the east section of the bridge was hinged to open from the south. This is important because the direction of the wind during the failure was from the south. The hatch covers were not provided with any positive hold-down devices [3.35]. Thus, water could enter the pontoons easily.

During the severe storm on February 13, 1979, the entire westerly section of the floating portion of the bridge sank. The sunken section, 1,151 m (3,775 ft) long from the center of the cross pontoon to the end of the draw pontoon in the extended position, included all 14 pontoons from the west end to the navigation channel. As identified on the State's drawings, these consist of [3.35]:

- 1 - Auxiliary Pontoon
- 1 - Cross Pontoon A
- 7 - Standard 110-m (360-ft) long Pontoons B through H
- 1 - Flare Pontoon I

2 - Flanking pontoons J and K

2 - Draw pontoons L and LL

In addition to the loss of the westerly floating bridge section, the canal end of the westerly transition truss span came off the supporting tower on the cross pontoon and fell into the canal. The landward end of the truss was still supported by the fixed pier until the truss was later removed by the State [3.35]. After failure of the Hood Canal Bridge, the cause of the failure was investigated by two groups [3.35, 3.37]. Results indicate that the failure was the possible result of a combination of poor maintenance, severe weather conditions, dynamic bridge response, and anchor movement. Recommendations have been made to rebuild the bridge using a floating concrete design, although the level of analysis required is still debated [3.38, 3.39].

A second study on the performance of a concrete bridge was performed at the Civil Engineering Research Institute in Japan [3.40]. A test program, performed during demolition of the bridge, was designed to determine the (1) material properties of the concrete, grout, prestressing tendons, and reinforcing bars, (2) the accuracy of the arrangement of the tendons, and (3) ultimate load of the beams. The results indicated a good comparison between calculated and test loads. The primary problem observed was corrosion of the prestressing tendons due to poor quality grout.

3.7 Barge Studies

3.7.1 Background

From the literature, it appears that increasing attention is being given to plant barges. For example, the first International Conference on Floating Plants was held in Paris, France, in October 1980, and the second Conference is scheduled for late 1982. This report has already mentioned several examples of the use of concrete such as in the Exxon Oil Refinery in Libya (Section 1.2), The Gulf of Mexico barges (Section 3.5.2), and the ARCO LPG Facility (Section 3.5.1). However, as Table 3.14 indicates, most of the recent process plant barges appear to be fabricated from steel rather than concrete.

Reference 3.41 presents some conceptual designs for large barges to be used for processing plants, and Reference 3.42 discusses the results of a detailed comparative study of 300-m-long concrete and steel barges designed to carry LPG. The tasks involved were:

- (a) Design a prestressed concrete [2.10] and a steel [3.43] barge according to current ABS rules for unrestricted service as LPG storage vessels.
- (b) Compare the strength and safety of the steel and the concrete hulls, including all likely modes of failure under a variety of loading conditions.

TABLE 3.14 PLANT BARGES (FROM [3.31])

| PLANT | DIMENSIONS (m) | MATERIAL | INSTALLATION | COMP. DATE | FABRICATION | OPERATION SITE |
|---|-----------------|----------|--------------|------------|--|---------------------------|
| Power (15MW Gas Turbine) | 62×15×— | Steel | Floating | 1959/1960 | Creole Petroleum | Maracail Lake (Venezuela) |
| Oil Refinery (10,000bbbls) | 55×24.5×5.35 | Concrete | Grounded | Nov. 1962 | Exxon (Belgium) | Marsa El Brega (Libya) |
| Power (155MW Gas Turbine) | 66×24×3.7 | Steel | Floating | 1971 | Marine Industries Soral Newport News (Canada/U.S.A.) | Brooklyn (U.S.A.) |
| Power (121MW Gas Turbine) | 66×24×3.7 | Steel | Floating | 1974 | Bath Iron Works (USA) | Brazil |
| Plywood Factory | 87×18×8 | Steel | Floating | Feb. 1976 | Alpi-Cam (Italy) | Cameroon |
| Refrigeration & Storage (60,000m ³ LPG) | 140.5×41.5×17.2 | Concrete | Floating | Sept. 1976 | Concrete Technology Corp. (U.S.A.) | Java Sea (Indonesia) |
| Pulp Plant (850 ton/d) | 230×45×14.5 | Steel | Grounded | 1978 | I.H.I. (Japan) | Brazil |
| Power (75MW Diesel) | 45×24×9 | Steel | Floating | 1978 | Astilleros Espanoles (Spain) | — |
| Mortal Plant (350m ³ /h) | 90×32×7.5 | Steel | Floating | 1978 | Mitsui (Japan) | Japan |
| Desalination (682 ton/d×3) | 65×20×6 | Steel | Floating | 1978 | K.H.I. (Japan) | Saudi Arabia |
| Bagging & Storage (Cement) (2,200 Bags/h×2) | 102.5×21×10.7 | Steel | Floating | 1979 | A.G. Weser (W. Germany) | — |
| Desalination (20,000 ton/d) | 70×40×12.5 | Steel | Floating | 1981 | Hitachi (Japan) | Saudi Arabia |
| Polyethylene Plant | 89×22.5×6 | Steel | Floating | 1981 | I.H.I. (Japan) | Argentina |
| Liquefaction & Storage (1,070,000m ³ NG/d) | 198.6×85.1×25 | Steel | Floating | 1981 | Moss-Rosenberg (Norway) | — |

TABLE 3.15 COMPARISON BETWEEN CONCRETE AND STEEL HULL CHARACTERISTICS (FROM [3.42])

| | <u>Main Dimensions</u> | <u>Concrete</u> | <u>Steel</u> |
|--------------------------------------|------------------------|-----------------|--------------|
| Length Overall | m (ft) | 296.8 (974) | 296.8 (974) |
| Length B.P | m (ft) | 292.0 (958) | 283.3 (930) |
| Breadth | m (ft) | 54.0 (177) | 54.0 (177) |
| Depth | m (ft) | 21.3 (70) | 21.3 (70) |
| Draft (full load) | m (ft) | 16.8 (55) | 8.8 (29) |
| Block Coefficient at Mean Water Line | | 0.966 | 0.966 |
| Total Displacement (metric tons) | | 261,660 | 134,830 |
| Deadweight (metric tons) | | 90,230 | 90,230 |
| Deadweight-Displacement ratio | | 0.34 | 0.67 |
| <u>Natural Frequencies</u> | | | |
| Heave frequency, Hz | | 0.095 | 0.097 |
| Pitch frequency, Hz | | 0.087 | 0.089 |
| Two-node frequency, Hz | | 0.478 | 0.313 |

The remainder of this section will present and discuss results from this comparative study.

Gerwick [3.42] indicates the following advantages of using prestressed concrete in these facilities:

"The use of prestressed concrete for constructing storage-processing vessels and oceangoing liquefied gas carriers may show certain advantages. Although concrete vessels have a lower deadweight/displacement ratio than a comparable-size steel ship, it is not necessarily a disadvantage for gas storage vessels. Because liquefied gas has such a low specific gravity (approximately 0.5), the cargo capacity of a steel ship is limited by volume rather than by weight. A heavier concrete hull of the same dimensions may still carry the same cargo volume, although at a greater draft. Thus a concrete vessel loaded with liquefied gas is not necessarily limited in cargo capacity by its own weight.

Since an offshore storage vessel will most likely be permanently moored at a single production site, it will make very few voyages in its lifetime. The additional expense of towing a heavier concrete hull on a limited number of voyages will be of little consequence in comparison to the total life cycle cost.

The brittleness of conventional shipbuilding steels at the extremely low temperatures necessary to maintain liquefied gas [-250 F (-157 C) for liquefied natural gas (LNG) and -45 F (-43 C) for liquefied petroleum gas (LPG)] raises difficult problems in the use of steel ships for transporting and storing liquefied gas. In contrast, prestressed concrete has good fatigue and brittleness properties at cryogenic temperatures. In addition, the greatest advantages of a concrete hull are its inherent durability, low maintenance cost, and safety under accident conditions. A concrete vessel could remain in service for 20 years or more without needing to be dry docked for painting, which is particularly beneficial in remote locations. Under maximum credible accidents, such as collision and fire, a properly designed and constructed prestressed concrete vessel has a better inherent safety than a comparable steel vessel."

3.7.2 Comparison of Design

Table 3.15 gives a comparison between the concrete and steel hull characteristics. The overall length, breadth, and draft were kept



constant for comparison purposes. The major difference is associated with the extra weight of the concrete structure, resulting in the large draft and displacement.

"The Proposed Method for Analyses of Prestressed Concrete Vessels," as given by ABS (1967) [2.10], was used as a guide for designing the concrete barge. The hull is designed to be classified for unrestricted service, that is, any ocean, any season. Factors of safety against longitudinal bending failure under design conditions were:

- (a) Concrete crushing 2.22
- (b) Concrete cracking 2.0, subsequently reduced to 1.5
- (c) Ultimate tension $1.95 = (1.3 \times 1.5)$

These factors of safety are with respect to the maximum stresses encountered in operational life. The load criterion used in the provisional rules is the quasistatic bending moment, with the vessel poised on a wave with an ABS effective height. A summary of the allowable stresses for the concrete and the prestressing steel is given in Table 3.16 [3.42].

The following iterative procedure was used in sizing the concrete members [3.42]:

1. All joints were assumed fixed against rotation, and the corresponding fixed-end moments (FEM) were calculated.
2. Each member was initially sized to carry, at the appropriate stress level, the largest FEM, or the largest moment expected.
3. From the initial member sizes, stiffnesses and joint-moment distribution factors were determined.
4. Actual moments were found by the moment distribution method.
5. Actual end and midspan moments were summarized for the six loading conditions, governing values were determined, and the members were resized accordingly.
6. The actual member sizes and corresponding moment distribution factors were compared with those initially estimated, or adjustments made until satisfactory agreement was obtained.
7. Shear stresses were examined in all the loading conditions in order to ensure that the allowable shear stress is not exceeded.

After the members were sized, a strength analysis was conducted on the complete concrete hull. Both conventional quasistatic analysis and more sophisticated calculations for the dynamic loads and thermal stresses were undertaken.

TABLE 3.16 SUMMARY OF ALLOWABLE STRESSES (FROM [3.42])

| <u>CONCRETE</u> | |
|--|-------------------------------------|
| <u>Given/Defined Strengths</u> | |
| $f'_c = 8,100$ psi | |
| $f_{cr} = 7.5 \sqrt{f'_c} = 675$ psi | ACI 318-71 Sec. 9.5.2.2 |
| $\tau = 10 \sqrt{f'_c} = 900$ psi | ACI 318-71 Sec. 11.16.5 |
| $E_c = 5.13 \times 10^6$ psi reduced to 3.6 x 10 ⁶ psi for cyclic loading | ACI 318-71 Sec. 8.3.1 |
| <u>Allowable Stresses</u> | |
| $-f_{c\lambda} = 0.45 f'_c = 3,545$ psi | $f_v = \frac{\tau}{1.65} = 545$ psi |
| $+f_{c\lambda} = 3.75 \sqrt{f'_c} = 337$ psi | $f_{pt} = 220$ psi |
| <u>Coefficient of Thermal Expansion</u> | |
| $\gamma_c = 4.26 \times 10^{-6}$ in/in - °F | |
| <u>PRESTRESSING STEEL</u> | |
| <u>Given/Defined Strengths</u> | |
| $f_u = 250,000$ psi | $E_s = 30 \times 10^6$ psi |
| $f_y = 200,000$ psi | |
| <u>Allowable</u> | |
| $P_I \leq 0.8 f_u = 200,000$ psi | $f_s \leq 0.6 f_u = 150,000$ |
| or | or |
| $P_e \leq 0.6 f_u = 150,000$ psi | $f_s \leq 0.8 f_y = 160,000$ |
| <u>Coefficient of Thermal Expansion</u> | |
| $\gamma_s = 6.30 \times 10^{-6}$ in/in - °F | |
| <ul style="list-style-type: none"> f'_c - ultimate compressive strength of concrete f_{cr} - ultimate tensile strength of concrete τ - ultimate shear strength of concrete E_c - modulus of elasticity of concrete $-f_{c\lambda}$ - allowable compressive stress under design load $f_{c\lambda}$ - allowable tensile stress under transverse loads f_v - allowable shear stress f_{pt} - allowable tensile stress under principal tension f_u - ultimate strength of steel f_y - yield strength of steel E_s - modulus of elasticity of steel P_I - allowable initial prestress P_e - allowable effective prestress f_s - allowable stress due to flexure and prestress | |

The static balance calculations consisted of balancing the vessels on a wave of an "effective wave height" specified by the 1977 ABS Rules for the Classification of Steel Vessels [3.43]. Loads, shear forces, and bending moments were computed for the still-water, hogging, and sagging wave profiles with the still-water draft corresponding to the following conditions:

- (a) Full load, 16.8-m (55-ft) draft
- (b) Empty, 10.7-m (35.03-ft) draft
- (c) Half-loaded, 13.8-m (45.33-ft) draft

The ABS effective wave height used in the calculations was 26.36 ft (8 m). The results of the computation are given in Table 3.17.

Analyses of the wave bending moments and shear forces were carried out. The calculations were done for the fully loaded draft using the SPRINGSEA II program [3.44]. The program uses structural elasticity and strip-theory results for the case of a steady wave excitation and the normal mode approach to determine the major vertical displacements. The computed natural frequencies are given in Table 3.15.

The analysis of the steel hull was made to compare certain aspects of the strength of the steel design with the concrete barge. The form and dimensions used were the same as for the concrete barge. It was also assumed that the general arrangement was the same [3.42].

The standard static balance calculations were carried out for the steel barge, with the results given in Table 3.17 for the fully loaded condition. These results can be used for comparison with the corresponding concrete version values. Although the calculations were not repeated for the ABS effective wave height, estimates were made and the results given in Table 3.17. They are well within the values implied in the ABS-required section modulus [3.42].

The program SPRINGSEA II, used for the dynamic analysis of the concrete hull, was also used for the steel hull. The inertia and shear area distribution were assumed similar in form to the concrete version. Calculations were conducted for both a towing speed of 4 knots and a stationary service speed of zero knots. The free vibration frequencies and mode shapes were computed with the frequencies listed in Table 3.15 [3.42].

The primary difference in the two resulting designs is the weight of the structures (Table 3.15). The concrete hull is 6.42 times heavier per unit length than the steel hull at midship. Table 3.15 indicates that the total displacement ratio between the concrete and steel hulls is 1.94. As noted earlier, this is not a great disadvantage when considering the weight of the cargo. There is no significant difference in the maximum bending moment and shear forces for both designs (Table 3.17) [3.42].

TABLE 3.17 STATIC BALANCE COMPARISON OF CONCRETE
AND STEEL HULLS (FROM [3.42])

| | Concrete | | Steel | |
|------------------------------|---|-------------------------------|------------------------------|-------------------------------|
| | ABS H_{eff} (26.36 ft) | $H_w=0.6L^{0.6}$ (36.9 ft) | ABS H_{eff} (26.36 ft) | $H_w=0.6L^{0.6}$ (36.9 ft) |
| Stillwater | | | | |
| Bending Moment, Ft-ton | 1.355×10^6 (hog) | 0.446×10^6 (hog) | 1.671×10^6 (hog) | 1.061×10^6 (hog) |
| Shear Force, Tons | 10,992 | 7,336 | 9,988 | 8,405 |
| Sagging Wave | | | | |
| Bending Moment, Ft-ton | 1.528×10^6 (3.2×10^6)* | 3.98×10^6 | 4.22×10^6 | 2.833×10^6 |
| Shear Force, Tons | 14,178 (18,372)* | 20,048 | 16,126 | 16,750 |
| Hogging Wave | | | | |
| Bending Ft-ton | 4.253×10^6 | 4.66×10^6 | 4.22×10^6 | 4.953×10^6 |
| Shear Force, Tons | 17,915 | 18,090 | 16,126 | 19,900 |

*Denotes the half-load condition. All other figures are for the full-load case.

From the results of the dynamic analyses, it is noted that the stiffness/mass ratio, EI/Δ , in the case of the concrete hull is approximately 22×10^6 and that for the steel, 1.45×10^6 . This is reflected in the natural frequencies of the two hulls, namely, 0.48 Hz for the two-noded mode of the concrete versus 0.31 Hz for the steel. This means that the steel vessel is likely to experience more dynamic effects than its concrete counterpart. In addition to the difference in the stiffness/mass ratio, the structural damping in the case of the steel hull is much less than in the concrete hull. This results in dynamic load factors for the concrete hull which are smaller than those for the steel hull [3.42].

3.7.3 Comparison of Margins of Safety

The first phase of the comparison was a study of the margins of safety for the concrete and steel designs. Two types of failure were considered [3.42]:

Service failure occurs when the structure is damaged so that its long-term strength is impaired, but the hull is still able to function in normal service and the ultimate strength is not reduced. Service failure is defined for:

1. Concrete hull - cracking due to flexure or shear.
2. Steel hull - yielding of local structural elements.

Collapse or fracture failure occurs when the structure is damaged so that it can no longer serve its intended function and could be called the "ultimate condition." It is defined for:

1. Concrete hull - concrete crushes, steel tendons break, fails in shear.
2. Steel hull - steel fractures or progressive inelastic buckling occurs.

The results of a deterministic calculation of the factors of safety are given in Table 3.18. It can be seen from the table that the factors of safety associated with the concrete hull are larger than those associated with the steel version.

In addition, a long-term probabilistic and semiprobabilistic safety analysis was performed. The results are given in Table 3.19. Although each safety method may have its own approximation, they were equally applied to the concrete and steel versions. The table shows that in all cases the concrete design has a higher safety margin than the ABS steel design.

TABLE 3.18 COMPARISON BETWEEN DETERMINISTIC FACTORS
OF SAFETY - CONCRETE VERSUS STEEL HULLS
(FROM [3.42])

| | Concrete | Steel |
|--|-----------------------------------|-------|
| Crushing of concrete versus yielding of steel | 1.78 | 1.42 |
| Ultimate concrete versus ultimate steel | 2.0 (ultimate) 4.48 (crushing) | 1.70 |

TABLE 3.19 COMPARISON OF PROBABILITIES OF FAILURE
AND SAFETY INDICES (FROM [3.42])

| | Concrete | Steel |
|--|--------------------------------|--------------------------------|
| <u>Probabilistic Analysis</u> | | |
| a. Most probable 21-year bending moment (ft-tons) | 1.430×10^6 (70.8%) | 1.817×10^6 (70.8%) |
| b. Still-water bending moment (SWBM) + the average $\frac{1}{1000}$ highest wave bending moment | 4.408×10^6 | 5.280×10^6 |
| c. Risk of tensile crack of the concrete hull versus yield of the steel hull | 2.71×10^{-7} | 7.51×10^{-7} |
| <u>SemiProbabilistic Safety Indices</u> | | |
| a. Concrete cracking versus steel yielding | 7.13 | 6.90 |
| b. Ultimate concrete and steel | 7.56 | 7.51 |

Note: Figures in parentheses indicate the probabilities of exceeding the given statistic.

3.7.4 Fatigue Characteristics of Concrete Hulls

The two barge designs were also evaluated for their long-term behavior under cyclic loading. For the concrete barge, the cyclic loading imposes stress ranges in axial (membrane) stress, shear, and bond which may result in cracking of the concrete. Provisions must be incorporated in the design to prevent deterioration due to this cracking and the resulting possibility of reinforcement corrosion. A prestressed concrete hull has extremely favorable behavior under long-term cyclic loading typical of the sea state history. In some cases the cracks tend to heal themselves. High-cycle fatigue does not appear to be a problem for uncracked concrete, nor for concrete with very small cracks (0.2 mm or less). Cracking should be restricted by using proper construction procedures and by using adequate degrees of prestress. Reference 3.42 indicates that providing up to one percent ordinary reinforcement in addition to the prestressing steel will give adequate resistance to crack propagation and hence prevent low-cycle fatigue of concrete and steel.

3.7.5 Summary of Barge Designs

In summary, the concrete and steel barges were analyzed, and the loads, stresses, strength, and safety margins were determined and compared. The loads and stresses were examined using the traditional static balance procedure with a variety of wave heights as well as the more advanced quasistatic and dynamic procedures, which are based on ship motion computation, with consideration given to the hulls' flexibilities. Thermal stresses were also determined for a range of air and water temperatures with radiant sun heat on the deck, as well as the cooling effect of storm winds and rain [3.42].

A variety of failure modes was considered in the comparative study, and the corresponding margins of safety were determined. The failure modes included cracking, crushing, or shearing and rupture of the steel tendons of the prestressed concrete hull as well as yielding and ultimate strength of the steel hull. Failure modes under repeated loading conditions were also evaluated for the concrete vessel, assuming a long-term history of sea states and the application of the consequent stress ranges to the determination of cumulative fatigue according to the Miner-Palmgren summation [3.42].

The safety margins were then computed for both hulls using three different approaches. The first was based on the static balance loads and deterministic factors of safety. The second approach was based on the quasistatic and dynamic loads and probabilities of failure computed from pure probabilistic procedures. The third approach was also based on the quasistatic and dynamic loads, but with safety indices computed from semiprobabilistic analysis. Each approach to the margin of safety has its own approximations, but reference 3.42 indicates since each was applied equally to both hulls, the approximations are not very important. The different approaches are used as a measure for showing the relative degree of safety.

Reference 3.42 concludes that once the economic problem associated with the low deadweight/displacement ratio of a concrete hull is overcome by carrying a low-density cargo such as LPG, the prestressed concrete hull was found to have adequate strength and safety to justify its use for vessels in hazardous cargo service.

3.8 Floating Platform Studies

3.8.1 General

The use of a permanently moored floating concrete platform for drilling, production, and storage of oil in deep water locations has been studied by several groups [3.45-3.47]. CONPROD [3.45] is based on the CONDEEP gravity platform design for use in the North Sea in water depths of 150 to 1000 m. It is a production platform with up to 800,000 barrels of storage capability. The F51 Platform [3.46] has similar design and service requirements as the CONPROD platform. A detailed design of the F51 platform was performed for a 200-m-deep site with the following environmental conditions:

100-year wave -- height: 32 m
 ~ period: 14 sec to 18 sec
Maximum wind -- 50 m/sec at 10 m above sea level
Current ~ 1 m/sec uniformly

Extensive design, analysis, and model testing have been performed on these two platforms. The third platform concept, the Arctic Caisson [3.47], is designed to function under ice loads of the low Arctic and will be discussed in some detail.

3.8.2 Arctic Caisson Design

3.8.2.1 Overview

The Arctic Caisson is designed for drilling, production, and storage of oil in the moderate ice conditions of the low Arctic. The platform was to be capable of carrying out developmental drilling and subsequent production of 100,000 barrels of oil per day. Storage of up to 500,000 barrels of oil was required for periods when ships are unable to reach the platform. The following environmental design criteria were assumed:

| | |
|-----------------------------|---|
| Water Depth | 300-1000 m |
| Operational Sea States | wave height 6 m, period 12 seconds wave height 4 m, period 7 seconds |
| Extreme Sea State | wave height 30 m, period 16.5 seconds |
| Surface Current | 0.6 m/sec |
| Tidal Range | 1-5 m |
| Maximum Wind Speed | 40 m/sec |
| Bedrock Acceleration | 0.25 g's |
| Annual Ice Thickness | 1.5 m |
| Multiyear Ice Thickness | 3 m |
| Unconsolidated Ridge Height | 30 m |
| Consolidated Ridge Height | 16 m |

Under these conditions, performance requirements of the platform were established. Pitch, roll, and heave were limited to the following values to permit drilling and processing to be carried out: roll and pitch to 7 degrees; heave to 1.5 m (single amplitude); and surge to 6 percent of the water depth (single amplitude). For extreme conditions, roll and pitch are limited to 12 degrees. Using these environmental and operational conditions, the platform was designed [3.47] based on the Det norske Veritas "Rules for Design, Construction and Inspection of Offshore Structures" [2.1] and the American Bureau of Shipping "Rules for Building and Classing Offshore Mobile Drilling Units" [3.48].

Figure 3.17 shows the general characteristics of the Arctic Caisson. The large base counteracts the wind and wave forces on the deck and column, reducing dynamic response as well as providing the oil storage area. Storage and some heavy equipment will be located in the lower portion of the shaft in an attempt to lower the center of gravity. Production equipment is located in the upper portion of the shaft and the drilling equipment and crew quarters are located on the upper deck. The unique design feature is the hourglass portion of the shaft at the waterline. This design was adopted to act as an icebreaker. High-strength concrete with either a steel plating or a polymer-impregnated concrete surface is used in this region to reduce ice abrasion. The small diameter at the throat, 15 m, will also reduce the loads due to ice passage. The structure is moored with a spread mooring consisting of sixteen 114-mm (4-1/2-in.) lines with clump weights, the latter serving to prevent overstress of any one line and progressive failure of the mooring system [3.47].

The seas under consideration are seasonal in character: ice covered in the winter and spring, open water in summer and fall. Thus the platform must be able to resist storm wave conditions as well as sea ice. The response of the structure to waves is determined to a large extent by the relationships between draft, base diameter, and shaft diameter. An optimum can be found for a specific configuration which will reduce the response to within acceptable limits during both service and extreme conditions. The responses to waves were calculated by a program which had been correlated with previous preliminary model tests on a floating caisson vessel system [3.47].

Open-water response characteristics for an intermediate size (200,000 tons) icebreaking caisson similar to the configuration shown in Figure 3.17 are given in Table 3.20. Further calculations showed that these responses, particularly heave response, could be further reduced, if desired, by ballasting down to a slightly deeper draft during a severe storm, although adequate freeboard must be maintained. These response data give a general indication for the motion characteristics of caisson vessels of the type under consideration. Detailed testing of accurately scaled models, both in open and ice-covered water, is required to obtain more definitive data on each specific caisson configuration and its associated mooring system [3.47].

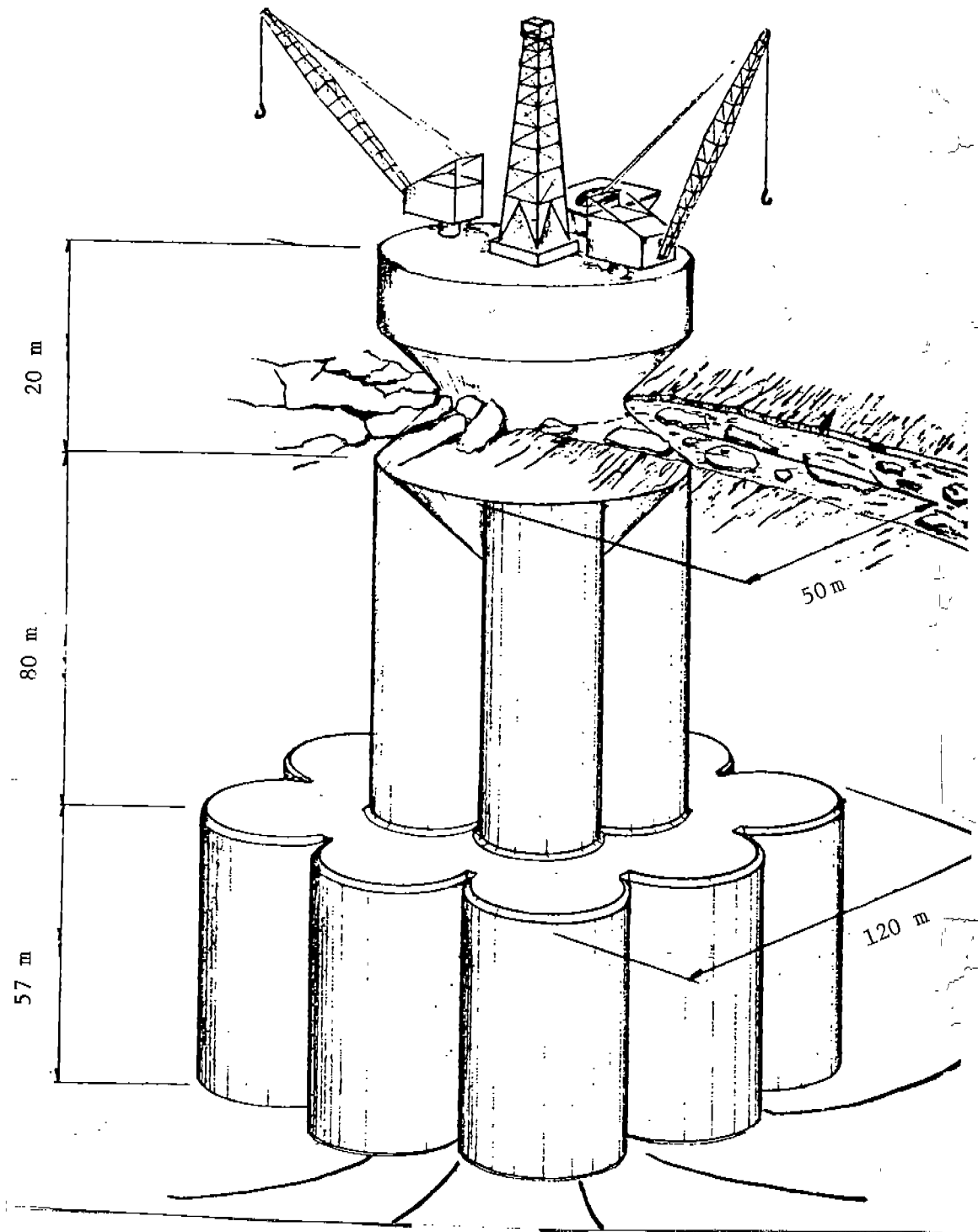

FIGURE 3.17 ISOMETRIC VIEW OF PROPOSED ARCTIC CAISSON
(FROM [3.47])

TABLE 3.20 PERFORMANCE IN OPEN WATER
FOR 200,000-TON DISPLACEMENT CAISSON
(FROM [3.47])

| Period (Sec.) | Heave 2 x Amp.* (Meters) | Roll + Pitch 2 x Amp. (Degrees) | Surge 2 x Amp. (Meters) | Horizontal Deck Motion 2 x Amp. (Meters) | Maximum Mooring Line Tension (KN) |
|---|--------------------------------|--|-------------------------------|--|---|
| A. Operating Condition | | | | | |
| <u>Maximum Wave Height, 12 m, $H_S = 6$ m</u> | | | | | |
| 8 | 0.3 | 2 | 1 | 5 | 900 |
| 9 | 0.5 | 2.5 | 1 | 6 | 910 |
| 12 | 1 | 3 | 2 | 9 | 920 |
| 14 | 2 | 3.5 | 3 | 11 | 940 |
| 16 | 4 | 4 | 4 | 13 | 960 |
| B. Survival (Extreme Design) Condition | | | | | |
| <u>Maximum Wave Height, 30 m, $H_S = 16$ m</u> | | | | | |
| 15 | 6 | 7.7 | 7 | 22 | 1,030 |
| 16 | 7.5 | 7.9 | 8 | 24 | 1,040 |
| 17 | 9 | 8.1 | 9 | 25 | 1,060 |

Note: The above calculations are for an intermediate version with a displacement of approximately 200,000 tons, a GM of 6 m, and a mooring system having sixteen 114-mm lines, in 500-m water depth.

* 2 x Amp. = Double Amplitude
GM = Metacentric Height
 H_S = Significant Wave Height

3.8.2.2 Ice Forces

For a structure that is either fixed or moored to the bottom, ice moving past the structure exerts substantial forces on the structure. The reaction of the structure on the ice causes the ice sheet to fracture in compression, shear, or tension. Cracks are propagated, and the broken ice is deflected upward or downward and also sideways from the structure. Finally, the broken ice fragments must be cleared past the structure. With the hourglass design the structure will operate as an icebreaker in both the upward and downward breaking modes. While the adopted configuration appears efficient in breaking the ice sheet, pressure ridges within the ice may offer large resistance (Table 3.21) which may require dynamic breaking, using the heave mode and the mass of the structure. To augment the dynamic capability of the structure, heave can be induced by setting up a resonant action at the natural period of the structure. To induce heave, several mechanisms may be feasible. One is a periodic pull-down on taut tension-leg mooring lines, using long-stroke hydraulic jacks such as the Lucker Intermittent Pulling Machines with a 1-2 m stroke. Preliminary calculations indicate that about 1200 horsepower, applied in proper cyclic sequence, would be able to induce the resonant heave response of the caisson [3.47].

A study of the various means of avoiding collision with icebergs led to the conclusion that, while tugs might be used for moderate-sized icebergs in the open-water season, lateral movement capabilities should be provided to take care of the exceptional iceberg and the case of icebergs embedded in annual ice. This movement could be imparted by use of the mooring system, augmented by the tugs and/or built-in thrusters. If necessary, the active heaving system may be used to reduce towing resistance in ice. However, as long as there is a possibility of collision with a large iceberg, provisions will have to be made to permit quick disconnect from the mooring system. Obviously, the moored-caisson concept is applicable only in those areas where the frequency of large icebergs is sufficiently low that the need to disconnect would arise only on rare occasions [3.47].

3.8.2.3 Model Tests

In addition to the design and analysis, a series of model tests was performed. Preliminary tests were carried out in the ARCTEC model basin at Columbia, Maryland, for a simplified caisson-vessel of the same general configuration, but substantially smaller in mass (170,000 tons versus 270,000 tons displacement for the caisson vessel shown in Figure 3.17). The 1:75 scale model permitted tests of either upward or downward icebreaking. The caisson was moored with two linear springs in a manner simulating a spread mooring system in 500-m water depth with a spring constant of about 200 KN/m. Provisions were installed for pneumatic and mechanical variations in ballasting in order to simulate the effect of actively induced heaving [3.47].

TABLE 3.21 PERFORMANCE IN ICE-COVERED WATERS
(FROM [3.47])

| Mode | G.M. | Ice Characteristics | | | Surge Meters | | Heave Meters | | Pitch Degree | |
|-------------------|------|--|-----------------------------------|-----------------|------------------|-----------------|------------------|------------------|------------------|------------------|
| | | Thick- ness Meters | Strength and Modulus Mpa | Velocity M/S | Passive Heave | Active Heave | Passive Heave | Active Heave | Passive Heave | Active Heave |
| Down- breaking | 6.1 | 2.5 | 1.1 | 0.01 | 37 | 13 | 1.2 | 2.1 | 6.5 | 3.2 |
| | | | | 0.05 | 22 | 11 | 1.4 | 2.1 | 4.4 | 2.1 |
| | | | | 0.11 | 18 | 6 | 1.3 | 2.1 | 3.3 | 2.2 |
| Up- breaking | 6.1 | 2.3 | 0.8 | 0.01 | 35 | 16 | 2.5 | 3.0 | 4.8 | 0 |
| | | | | 0.05 | 33 | 21 | 2.8 | 3.3 | 4.9 | 2.7 |
| | | | | 0.11 | 26 | 18 | 3.0 | 3.3 | 4.3 | 2.5 |
| Up- breaking | 6.1 | 2.3 plus 14M Ridge ¹ | 0.8 140 | 0.11 | 36 | 22 | 2.8 | 3.3 | 4.0 | 2.7 |
| Down- breaking | 6.1 | 2.5 plus 37M Ridge ¹ | 1.1 - | 0.11 | 58 ² | 65 ² | 0 | 1.4 ² | 7.5 ² | 8.9 ² |

Notes:

¹Ridges are unconsolidated ridges embedded in ice sheet.

²Test terminated when surge stops were reached. Values are limiting values at end of run.

³The above values are full-scale values as determined by tests with a model simulating a 170,000-ton caisson.

3.73

486-328

105

105

Results indicate that the downward-breaking mode was clearly superior to the upward-breaking mode, and active heaving was found to be beneficial in both cases, particularly at low ice sheet velocities. Vessels' motions in both heave and pitch were within allowable limits. With actively induced heave, the maximum heave amplitudes were 3.5 m in the upward-breaking mode and 2 m in the downward-breaking mode; these heave amplitudes proved adequate to break the ice continuously. Also, with active heaving, pitch amplitudes were in the range from 2 to 3 degrees for both configurations. In general, the downward-breaking mode effectively reduced the structure's response by a factor of 1.5 to 3 [3.47].

A few model tests were conducted to study the effect of unconsolidated pressure ridges on a moored caisson. Ridges were constructed by piling broken ice both on top and below the solid ice sheet. The ridge sail and keel had triangular profiles of the same width, but of different angles of repose: 4 degrees and 32 degrees, respectively. The heaving system was again found to be very effective. The downward-breaking version broke through a 14-m-thick ridge with 22-m excursion. The upward-breaking version was tested only with a 37-m-thick ridge, which it could not penetrate without exceeding the allowable excursion. Table 3.21 summarizes the results of the model tests. These data were utilized in the design of the mooring system for the structure shown in Figure 3.17 and for environmental conditions given previously. This required some extrapolation of the model results for (1) from 2.5- to 3-m sheet ice thickness, (2) from 14- to 30-m ridge thickness, and (3) for an increase in the caisson size. Extrapolated values for the maximum tension in the proposed 16-line mooring system with 114-mm (4-1/2-in.) lines were within allowable limits [3.47].

3.8.2.4 Arctic Caisson Results

The conclusions of the Arctic Caisson study are listed below [3.47]:

1. A moored, floating caisson is a practical production concept for deep water in subarctic environments, having moderate ice conditions in winter and extreme storms during the open-water summer season.

The model tests indicate that a caisson can be designed to have satisfactory performance and safety under the operating and extreme environmental conditions considered in this study.

2. The hourglass, or double-cone, configuration forces the ice to break in tension and shear, and thus reduces total forces. Both upward-breaking and downward-breaking modes can be adopted, the latter being the more effective in reducing mooring-line tensions and increasing

stability. An alternative configuration, with downward-breaking cone only and with a straight shaft, may also be attractive.

3. Actively induced heaving is an effective means of breaking the ice sheet and ridges and reduces the responses in surge, pitch, and mooring-line tensions significantly. This heaving will be at the natural period of the structure and can be induced by hydraulic pull-down on vertical mooring lines or by periodic release of compressed air or gases.
4. The structure should be constructed of reinforced and prestressed concrete. Particular attention needs to be devoted to providing sufficient shear resistance in the throat region, which can be accomplished by use of very high-strength concrete, axial post-tensioning, and cross-wall stirrups. Abrasion resistance and a low-friction surface can be best provided by use of an armor of polymer-impregnated concrete.
5. A study of construction methods and costs showed that the structure is practicable and is within current state-of-the-art capabilities.
6. It appears that the basic concept can be extended, with appropriate modifications, to heavier (Arctic) ice conditions.

REFERENCES

- 3.1 Anderson, Arthur R., "Prestressed Concrete Floating Structures (State of the Art)," paper presented at SNAME Spring Meeting, Vancouver, British Columbia, May 1975.
- 3.2 Tuthill, Lewis H., "Concrete Operations in the Concrete Ship Program," Journal of the American Concrete Institute, Vol. 16, No. 3, Jan. 1945.
- 3.3 Campbell, R. A., Chang, K. T., and Stiansen, S. G., "Classification of Concrete Ships: Historical Background and Current Practice," Concrete Afloat, The Concrete Society, London, 1977.
- 3.4 Vasta, John, "The Concrete Ship Program of World War II," Paper presented before the Chesapeake Section of SNAME on May 8, 1952.
- 3.5 Anderson, Arthur R., "The Development of Concrete Ships and Vessels," Conference on Concrete Ships and Floating Structures, University of California, Berkeley, Sept. 1975.
- 3.6 Structural Lightweight-Aggregate Concrete for Marine and Offshore Applications, Concrete Society Technical Report No. 16, London, May 1978.

- 3.7 Morgan, R. G., "History of and Experience with Concrete Ships," Conference on Concrete Ships and Floating Structures, University of California, Berkeley, Sept. 1975.
- 3.8 "Concrete Ships May be Safe Against Atom Bomb," Scripps-Howard Press, July 3, 1946.
- 3.9 Furnes, Olav, and Loset, Oystein, "Shell Structures in Offshore Platforms, Application and Design," IASS-20th Anniversary World Congress, Madrid, September 1979.
- 3.10 "Statfjord B CONDEEP," Brochure from Norwegian Contractors.
- 3.11 Norge, Elf, "Frigg Field Treatment and Compression TCP2 Platform," Jan. 1976.
- 3.12 Graff, William J., and Chen, Wai F., "Bottom-Supported Concrete Platform: Overview", ASCE Journal of the Structural Division, Vol. 107, No. ST 6, June 1981.
- 3.13 Fjeld, Svein, "Concrete Structures," Publication of Det norske Veritas.
- 3.14 Olsen, Olav, "Design of CONDEEP Concrete Structure," Symposium at Norwegian Institute of Technology, Trondheim, Oct. 1978.
- 3.15 Naesje, K., Dahl, P.C., and Moksnes, J., "Structural Damage in an Offshore Concrete Platform, the Cause and the Cure," 8th FIP Congress, London, May 1978.
- 3.16 Moksnes, J., "CONDEEP Platform for the North Sea - Some Aspects of Concrete Technology," OTC Paper No. 2369, Houston, Texas.
- 3.17 Moksnes, J., "Concrete in Offshore Structures," Concrete Structures, Symposium at Norwegian Institute of Technology, Trondheim, Oct. 1978.
- 3.18 Fjeld, Svein, "Experience from In-Service Inspection and Monitoring of 11 North Sea Structures," Colloque, A.F.P.C. - A.R.B.E.M., Brent, Oct. 1980.
- 3.19 Fougner, N. K., "Seagoing and Other Concrete Ships," Frowde and Hodder and Stoughton, Oxford Technical Publications, London, 1922.
- 3.20 Højgaard, K., "The Development of Reinforced Concrete Shipbuilding During the War," Paper read to Danish Society of Engineers, Feb. 1920.
- 3.21 Thurston, T. G., Owens, "On the Design and Construction of a Self-Propelled Reinforced Concrete Seagoing Cargo Steamer Now Building in Great Britain," Transactions Institution of Naval Architects, Vol. 60, pp 154, 1918.

- 3.22 Haviland, Jean, "American Concrete Steamers of the First and Second World Wars," American Neptune Magazine, Vol. 22, No. 3, pp 157-183, 1962.
- 3.23 "A Report of an Investigation on the Condition of Physical Properties of Expanded Shale Reinforced Concrete after 34 Years Exposure to Sea Water," Expanded Shale, Clay and Slate Institute, Washington, D.C., Nov. 1953 (2nd Edition 1960).
- 3.24 Gerwick, B. C., Jr., and Hognestad, E., "Concrete Oil Storage Tank Placed on North Sea Floor," Civil Engineering, ASCE, Aug. 1973.
- 3.25 Clausen, C. J. F., Dibiagio, E., Duncan, J. M., and Andersen, K. H., "Observed Behavior of the Ekofisk Oil Storage Tank Foundation," Offshore Technology Conference, OTC Paper 2373, May 1975.
- 3.26 "Concrete Gravity Structures," Technical Brochure, Marine Concrete Structures, Inc., New Orleans, Louisiana.
- 3.27 Anderson, A. R., "World's Largest Prestressed LPG Vessel, Design-Construction-Marketing," Journal of Prestressed Concrete Institute, Vol. 22, No. 1, Jan.-Feb. 1977.
- 3.28 Anderson, A. R., "A 65,000 Ton Prestressed Concrete Floating Facility for Offshore Storage of LPG," Marine Technology, SNAME, Vol. 15, No. 1, Jan. 1978, pp 14-26.
- 3.29 "Technical Brochure for MARS (MES Assembled Plant System) and Concrete/Steel Hybrid Marine Structure," Mitsui Engineering & Shipbuilding Co., Ltd., Tokyo, Japan, July 1979.
- 3.30 Emi, H., Kobayashi, R., and Noguchi, K., "Study of the Structural Design Method of Concrete Barge," International Symposium on Offshore Structures, Brazil Offshore '79, Oct. 1979.
- 3.31 "Taisei Concrete Barge System," Technical Brochure Taisei Corporation, Tokyo, Japan.
- 3.32 Giuffre, A., and Pinto, P. E., "Genoa's Floating Prestressed Concrete Dock, Computer Aided Design Analysis of Creep and Shrinkage Effects," Sogene, Rome, 1974.
- 3.33 Oda, T., "Outline of the East Tomakomai Industrial Development Project," Civil Engineering in Japan, circa 1979.
- 3.34 Eddie, A. G. F., "Lesson learned from two major floating concrete structures projects in Australia," Concrete Ships and Floating Structures Convention, Rotterdam, Nov. 1979.
- 3.35 "Hood Canal Floating Bridge, Phase I, Report on Determination of the Cause of Failure," for State of Washington Dept. of Transportation, Tokola Offshore and Earl and Wright Consulting Engineers, Aug. 1979.

- 3.36 Hartz, B. J., "Summary Report on Structural Behavior of Floating Bridges," University of Washington, Department of Civil Engineering for the Washington State Department of Highways, Contract Y-909, June 1972.
- 3.37 Hartz, B. J., "The Hood Canal Bridge Failure, A Report of an Independent Investigation," private communication, Sept. 1979.
- 3.38 "Hood Canal Floating Bridge Study, Phase II, Report on Recommendations for Replacement Structure," for State of Washington Department of Transportation, Tokola Offshore and Earl and Wright Consulting Engineers, Oct. 1979.
- 3.39 Hartz, B. J., "Hood Canal Bridge Failure and Replacement," private communication, Nov. 1979.
- 3.40 Kakuta, K., and Ohta, T., "Investigation on the Prestressed Concrete Highway Bridge Which Stood 20 Years Under Traffic," FIP 8th Congress, 1978.
- 3.41 Eddie, A. G. F., Shin, D. S., Sanders, T. G., and Hawrych, J. R., "Proposal for the Construction of Prestressed Concrete Super-Barges for Process Plants," Concrete Ships and Floating Structures Convention, Rotterdam, Nov. 1979.
- 3.42 Gerwick, B. C., Jr., Mansour, A. E., Price, E., and Thayanballi, A., "Feasibility and Comparative Studies for the Use of Prestressed Concrete in Large Storage/Processing Vessels," Transactions SNAME, Vol. 86, 1978.
- 3.43 "Rules for Building and Classing Steel Vessels," American Bureau of Shipping, New York, 1977.
- 3.44 Stiansen, S. G., Mansour, A., and Chen, Y. N., "Dynamic Response of Large Great Lakes Bulk Carriers to Wave-Excited Loads," Transactions, SNAME, Vol. 85, 1977.
- 3.45 Kure, G., "CONPROD, a floating concrete oil production platform," Concrete Ships and Floating Structures Convention, Rotterdam, Nov. 1977.
- 3.46 "Introducing F51 Concrete Floating Platform," Sea Tank Co, Technical Brochure, Paris.
- 3.47 Gerwick, B. C., Jr. and Johns, H. O., "Conceptual Design of Floating Drilling Production and Storage Caisson for Arctic Waters," Port and Ocean Engineering Under Arctic Conditions, Norwegian Institute of Technology, 1979.
- 3.48 "Rules for Building and Classing Offshore Mobile Drilling Units," American Bureau of Shipping, New York, 1973.

110

4.0 SUMMARY OF RESEARCH ACTIVITIES

4.1 Introduction

The state-of-the-art review conducted as part of this program revealed significant research activities, both in the U.S. and abroad, dealing with concrete for marine applications. While the majority of the research does not specifically address floating concrete structures, the results are applicable to this technology.

Sections 4.2 - 4.5 of this chapter* describe several of the large, coordinated research programs in the United States, the United Kingdom, the Netherlands, and Norway. Only research programs which the investigators feel are directly applicable to floating concrete structures are included. Further information concerning this research can be obtained from the appropriate sources given below:

American Concrete Institute
P.O. Box 19150
Detroit, Michigan 48219

Portland Cement Association
Research and Development Laboratories
Old Orchard Road
Skokie, Illinois 60076

Concrete Laboratory
U.S. Army Engineer Waterways Experiment Station
P.O. Box 631
Vicksburg, Mississippi 39180

Science Research Council
Marine Technology Directorate
Garrick House
3-5 Charing Cross Road
London WC2H 0HW
United Kingdom

UK Concrete in the Oceans Program
Marine Technology Support Unit
AERE, Harwell, Oxon OX110RA
United Kingdom

or

Construction Industry Research and
Information Association (CIRIA)
6 Storey's Gate
Westminster, London SW1P 3AU
United Kingdom

*Some information in this chapter is quoted directly from published documents. In such cases, the appropriate reference will be noted at the end of each paragraph.

Cement and Concrete Association
The Director of Research and Development
Wexham Springs
Slough, SL3 6PL
United Kingdom

Netherlands Industrial Council
for Oceanology (IRO)
P.O. Box 215
2600 AE
Delft, The Netherlands

Det norske Veritas
P.O. Box 300
N-1322 Høvik
Oslo, Norway

The University of Trondheim/
The Foundation of Scientific and Industrial Research at
The Norwegian Institute of Technology
N 7034 Trondheim - NTH
Norway

Sections 4.6 - 4.11 describe the research efforts and results of several programs which are particularly applicable to floating concrete technology.

This chapter, along with Chapters 1.0 - 3.0, will serve as the basis for the recommendations presented in Chapter 5.0.

4.2 United States

4.2.1 American Concrete Institute

A research report form developed by American Concrete Institute (ACI) Committee 115, Current Research, was published in issues of the 1978 and 1979 ACI JOURNAL. The form was developed because the committee believed that an annual listing of active research projects in concrete materials, structures, and construction would make an important contribution to healthy growth and innovation in the concrete industry. The purpose of the form was to collect data on current research projects, publish a compilation of the data, and make copies of the original report forms (abstracts) available to interested individuals and institutions at a nominal charge.

The research report forms asked for information on the project title, principal investigator(s), reporting institutions, sponsors, and the current status of the project. The form contained an index list which divided the many areas of concrete research into categories; reporting agencies were asked to select a category for their project, and also to outline the objectives, scope, and potential applications of the project. Each report form was assigned a code number and sorted into the assigned category. Many projects, of course, could not be neatly categorized into a single area. For this compilation, the most appropriate category was selected.

The two ACI committees on research, 114 and 115, have been recently merged into a single unit, Committee 123, to consolidate the research activities.

The August 1978 [4.1] and December 1979 [4.2] issues of the ACI Journal list research projects by (1) project category, (2) project title, and (3) principal investigator and application. In these two years, some 533 projects were reported in 17 countries according to Tables 4.1 and 4.2. Collecting data on worldwide concrete research activity has been suspended by ACI; reference 4.2 contains the latest information published.

The 533 projects reported in references 4.1 and 4.2 were reviewed, and Table 4.3 lists those most directly applicable to marine concrete structures.

4.2.2 Portland Cement Association

The Research and Development Laboratories of the Portland Cement Association (PCA) over the years has sponsored a large number of research programs. PCA is an organization of cement manufacturers whose objective is to improve and extend the use of portland cement and concrete through scientific research, engineering field work, and market development. Reference 4.3 contains a list with abstracts of the PCA Research Department Bulletins 1-227, which cover 227 projects in the period 1939-1968. Abstracts of the 49 projects from 1968-1978 (Bulletins RD001 - RD049) are reported in reference 4.4. While the main thrust of the PCA activities is not specifically directed at the use of concrete in floating marine structures, many of the programs concerned with material properties and the effect of the ocean environment are applicable.

One project, an "Inspection Guide for Reinforced Concrete Vessels" [4.5], was completed for the U.S. Coast Guard in October 1981. Part 1 contains a checklist for inspectors and covers such topics as (1) preliminary inspection, (2) materials, (3) batching and mixing concrete, (4) inspection before concreting, (5) inspection during concreting, (6) inspection after concreting (7) in-service inspection, (8) in situ testing of hardened concrete, and (9) repairs. The appendices contain a list of applicable standards, guides, and recommended practices. Part 2 contains the technical commentary on the above listed topics as well as a historical background of concrete vessels and design and construction considerations. In many areas, reference 4.5 and this report overlap. However, this report's emphasis is on experience, design, and applicable research, while reference 4.5 is directed towards construction.

4.2.3 Concrete Laboratory, U.S. Army Engineer Waterways Experiment Station (WES)

For a number of years the Concrete Laboratory has been active in research programs to meet the needs of the Corps of Engineers. The scope of such studies includes concrete materials, methods, and equipment; laboratory and field investigations of concrete control; and concrete, grouts, and grouting. Reference 4.6 indicates that the Corps has been very interested in research and technology transfer. Much time and effort

TABLE 4.1 RESEARCH IN PROGRESS AS REPORTED
BY ACI COMMITTEE 115

| | 1978 | 1979 |
|---|------------|------------|
| Materials for Concrete | | |
| Admixtures | 12 | 17 |
| Aggregates | 12 | 8 |
| Cements | 8 | 8 |
| Cement Paste | 2 | 4 |
| Mortars | 2 | 0 |
| Resins | 3 | 4 |
| Water | 1 | 0 |
| Production of Concrete | | |
| Curing | 3 | 2 |
| Formwork | 1 | 2 |
| Quality Control | 2 | 8 |
| Placing | 0 | 4 |
| Proportioning | 0 | 3 |
| Properties of Plain Concrete | | |
| Mechanical | 34 | 31 |
| Moisture-dependent | 2 | 6 |
| Thermal | 2 | 7 |
| Reinforcing Materials and Their Properties | | |
| Fibers | 8 | 5 |
| Reinforcing Steel | 6 | 1 |
| Prestressing Steels | 2 | 0 |
| Structural Concrete - Behavior, Analysis, Design | | |
| Bridges | 16 | 12 |
| Buildings | 12 | 13 |
| Cast-in-Place Concrete | 1 | 0 |
| Dams | 2 | 1 |
| Elements | 3 | 18 |
| Foundations | 2 | 0 |
| Joints | 7 | 8 |
| Offshore Structures | 2 | 5 |
| Precast Concrete | 6 | 4 |
| Prestressed Concrete | 22 | 16 |
| Reactors (Nuclear) | 4 | 2 |
| Reinforced Concrete | 21 | 32 |
| Concrete Construction | | |
| Concrete Pavements | 10 | 6 |
| Construction Projects | 1 | 4 |
| Special Materials | 2 | 6 |
| Sealants | 1 | 1 |
| Special Techniques | 8 | 5 |
| Durability | 19 | 18 |
| Earthquake Resistance | 5 | 21 |
| Fire Resistance | 5 | 1 |
| Wear | 0 | 1 |
| TOTALS | 249 | 284 |

TABLE 4.2 RESEARCH BY COUNTRY AS REPORTED
BY ACI COMMITTEE 115
(FROM [4.2])

| Country | Number of Reports | |
|--------------------------|-------------------|------------|
| | 1978 | 1979 |
| Canada | 32 | 2 |
| England | 15 | 37 |
| Germany | 16 | 15 |
| Israel | - | 18 |
| Italy | - | 2 |
| Japan | 3 | 86 |
| Mexico | 1 | - |
| Netherlands | 29 | - |
| New Zealand | - | 29 |
| North Ireland | 2 | 2 |
| Norway | - | 1 |
| South Africa | 18 | - |
| Spain | - | 1 |
| Sweden | 8 | 12 |
| Switzerland | 1 | - |
| United States of America | 123 | 79 |
| Venezuela | 1 | 1 |
| | 249 | 284 |

4.4

486-328

114

114

TABLE 4.3 RESEARCH PROJECTS DIRECTLY APPLICABLE TO MARINE CONCRETE STRUCTURES AS REPORTED BY ACI COMMITTEE 115

| <u>Project No.</u> | <u>Title</u> |
|---|---|
| <u>1 - Materials for Concrete</u> | |
| <u>1.3 Cements</u> | |
| 1.3-170-78 | "Cement Based Systems for Repair," National Research Council of Canada (Canada). |
| <u>2 - Production of Concrete</u> | |
| <u>2.1 Curing</u> | |
| 2.1-053-79 | "Properties of Structural Concrete in Cold Weather," Technical Research Institute, Ohbayashi-Gumi Ltd.(Japan). |
| <u>3 - Properties of Plain Concrete</u> | |
| <u>3.3 Mechanical</u> | |
| 3.3-100-78 | "Investigation on the Strength of Lightweight Concrete with Very Low Density Under High Sustained Load - F98," Institut fur Bauforschung (Germany). |
| 3.3-114-78 | "Tensile Impact Strength of Concrete," Delft University of Technology, Stevin Laboratory (The Netherlands). |
| 3.3-187-79 | "Behavior of Concrete Under Single and Repeated Impact Loads," Department of Architecture, Kyushu University (Japan). |
| <u>4 - Reinforcing Materials and Their Properties</u> | |
| <u>4.1 Fibers</u> | |
| 4.1-212-78 | "Static and Fatigue Properties of Ferrocement," University of Illinois at Chicago Circle (USA). |
| <u>4.2 Reinforcing Steel</u> | |
| 4.2-269-79 | "Long-Term Fatigue of High-Strength Reinforcing Steel," Portland Cement Association (USA). |
| <u>5 - Structural Concrete - Behavior, Analysis, Design</u> | |
| <u>5.8 Offshore Structures</u> | |
| 5.8-161-78 | "Analysis of Concrete Cylinder Structures Under Hydrostatic Loading," School of Civil Engineering, Purdue University (USA). |

TABLE 4.3 RESEARCH PROJECTS DIRECTLY APPLICABLE TO MARINE CONCRETE
STRUCTURES AS REPORTED BY ACI COMMITTEE 115 (Cont'd)

- 5.8-248-78 "Stability of Concrete Shells," Institute TNO for Building Materials and Building Structures (IBBC - TNO) (The Netherlands).
- 5.8-252-79 "Analysis of Concrete Cylindrical Hulls with Actual End Conditions," School of Engineering, Purdue University (USA).
- 5.8-289-79 "Concrete Cylindrical Structures Under Hydrostatic Loading," Civil Engineering Laboratory, Naval Construction Battalion Center, Port Hueneme, California (USA).
- 5.8-290-79 "Concrete Spherical Structures in the Deep Ocean Environment," Civil Engineering Laboratory, Naval Construction Battalion Center, Port Hueneme, California (USA).
- 5.8-035-79 "Temperature Gradients," Cement and Concrete Association (England).

5.12 Reinforced Concrete

- 5.12-291-78 "Development of Reinforcing Bar Splice Details," Portland Cement Association (USA).

6 -- Concrete Construction

6.5 Special Techniques

- 6.5-082-79 "Development of New Placing Method of Underwater Concrete," Research Laboratory, Shimizu Construction Company (Japan).

7 -- Concrete Performance

- 7.1-201-78 "Effects of Low Temperatures on Concrete," Canada Centre for Mining and Energy Technology, Department of Energy, Mines and Resources (Canada).
- 7.1-051-79 "Long Term Performance of Concrete in Structures," Cement and Concrete Association (England).

is spent keeping abreast of concrete research being performed by others so that duplicate programs will not be funded. The Concrete Laboratory publishes a number of documents which include:

- Bulletins and Handbooks
- Miscellaneous Papers
- Technical Memoranda
- Technical Reports
- Concrete Technology Information Analysis Center Reports
- Contracts Reports

Reference 4.7 lists the publications of the Concrete Laboratory, and Table 4.4 contains those which are most applicable to the use of concrete in floating marine structures. The reports can be obtained, using the given AD number, from the National Technical Information Service, U.S. Department of Commerce, Springfield, Virginia.

The Corps of Engineers also operates a facility at Treat Island, Maine, for natural weathering of concrete materials. Past and present research activities are described in Section 4.6.

4.3 United Kingdom

4.3.1 United Kingdom's Science Research Council (SRC) Marine Technology Program [4.8]

The Science Research Council was set up in 1965. It was charged to support research in science and technology at universities and to make grants for postgraduate education and training in relevant fields. Part of SRC's function is to consider important, topical fields of activity and determine the need for the Council to take specific action which will encourage academic interest and develop academic expertise as an investment on behalf of the United Kingdom.

The importance of the oceans as a natural resource was apparent long before North Sea oil production began. For some years, beginning in 1970, the SRC undertook investigations of the potential role of academic institutions in marine technology. Following the report of a Task Force, the Council made special arrangements to develop academic involvement in the area and set up a Marine Technology Directorate in May 1977.

The main part of the present program comprises awards to six major Centers which have enabled a start to be made towards the development of wide-ranging multidisciplinary research programs and expertise that will attract the continuing interest and involvement of industry.

The total Marine Technology Program is divided into the following areas:

- A Structures (i): Materials, Fabrication, and Repair
- B Structures (ii): Performance and Response
- C Surface and Underwater Systems
- D Electronics and Instrumentation

TABLE 4.4 RESEARCH PROJECTS DIRECTLY APPLICABLE
 TO MARINE CONCRETE STRUCTURES AS REPORTED BY
 CONCRETE LABORATORY, U.S. ARMY WATERWAYS EXPERIMENT STATION
 (FROM [4.7])

| <u>Number</u> | <u>Date</u> | <u>Title</u> | <u>AD Number</u> |
|--|-------------|--|------------------|
| <u>Miscellaneous Papers</u> | | | |
| C-70-3 | Jan 1970 | Behavior of Concrete Exposed to the Sea, by Bryant Mather | AD A029 801 |
| C-75-4 | Jun 1975 | Use of Fiber-Reinforced Concrete in Hydraulic Structures and Marine Environments, by G.C. Hoff | AD A010 640 |
| C-77-12 | Oct 1977 | Concrete Ships and Vessels - Past, Present, and Future, by T. C. Liu and J. E. McDonald | AD A045 706 |
| <u>Technical Reports</u> | | | |
| 6-782 | Jun 1967 | Freezing-and-Thawing Tests of Concrete of Various Strengths and Air Contents, by E. C. Roshore | AD 654 800 |
| C-72-2 | Aug 1972 | Cement Durability Program, Long-Term Field Exposure of Concrete Columns, by E. C. Roshore | AD 747 355 |
| C-74-3 | Jul 1974 | Laboratory Investigation of Slipform Construction for Use in Mass Concrete Structures, by K. L. Saucier | AD 784 094 |
| C-76-3 | Sep 1976 | Evaluation of Admixtures for Use in Concrete to be Placed Underwater, by W. O. Tynes | AD A031 002 |
| C-78-4 | Sep 1978 | Maintenance and Preservation of Concrete Structures, Report 1, Annotated Bibliography 1927-1977, by T. C. Liu, E. F. O'Neil, and J. E. McDonald | AD A062 694 |
| <u>Concrete Technology Information Analysis Center Reports</u> | | | |
| CTIAC-9 | Dec 1972 | Use of Recycled Concrete as Aggregate, by A. D. Buck | AD A029 832 |
| CTIAC-10 | Feb 1974 | Research and Development of Fiber- Reinforced Concrete in North America, by G. C. Hoff | AD A029 823 |

(118)

TABLE 4.4 RESEARCH PROJECTS DIRECTLY APPLICABLE
 TO MARINE CONCRETE STRUCTURES AS REPORTED BY
 CONCRETE LABORATORY, U.S. ARMY WATERWAYS EXPERIMENT STATION
 (FROM [4.7]) (Continued)

| <u>Number</u> | <u>Date</u> | <u>Title</u> | <u>AD Number</u> |
|---------------|-------------|---|------------------|
| CTIAC-11 | Dec 1972 | Concrete Technology Information Analysis Center (CTIAC), Evaluation of Pilot Study, by Bryant Mather | AD 755 837 |
| CTIAC-16 | May 1975 | Use of Regulated-Set Cement in Cold Weather Environments, by G. C. Hoff, B. J. Houston, and F. H. Sayles | AD A011 265 |
| CTIAC-21 | Jun 1976 | Selected Bibliography on Fiber-Reinforced Cement and Concrete, by G. C. Hoff, C. M. Fontenot, and J. G. Tom | AD A032 082 |
| CTIAC-24 | May 1977 | Creep of Concrete Under Various Temperature, Moisture, and Loading Conditions, by J. E. McDonald | AD A040 655 |
| CTIAC-26 | Aug 1977 | The Effect of Alkalies on the Properties of Concrete, <u>edited</u> by A. B. Poole | AD A044 565 |
| CTIAC-35 | Jan 1979 | US-USSR Scientific Exchange Program in the Field of Polymer Concrete, by J. M. Scanlon | AD A065 318 |
| CTIAC-36 | Jan 1979 | Quality Control During Hot and Cold Weather Concreting, by J. M. Scanlon | AD A066 989 |
| CTIAC-37 | May 1979 | High-Strength Concrete, Past, Present, Future, by K. L. Saucier | AD A069 881 |
| CTIAC-40 | Jun 1979 | Repair of Concrete Surfaces Subjected to Abrasion and Erosion Damage, by J. E. McDonald and T. C. Liu | AD A073 085 |

- E Fluid Mechanics
- F Sea-bed Studies/Soil Mechanics
- G Petroleum Engineering
- H Environmental Sciences
- J Other (currently comprising: Economics and Management, Marine Engineering, Diving, Training and Ocean Mining)

Appendix B summarizes, as of September 1979, the objectives and status of research programs which are relevant to the use of concrete in marine structures.

4.3.2 Concrete in the Oceans Program

In March 1976 the UK Government Department of Energy and twenty-four industrial firms through the Construction Industry Research and Information Association (CIRIA) jointly funded a program of seven projects. Their purpose was to provide additional knowledge to improve the design, construction, and long-term performance of concrete oil production platforms and other marine structures. Participation in the program is open to all international oil companies and to certifying authorities approved by the UK Department of Energy, as well as to all UK industrial, professional, and research organizations.

The program is managed by a three-man committee which represents the sponsors. Each sponsoring organization also has a representative on one of three technical steering groups which advise on the work on the various projects.

The projects are undertaken by research design or construction organizations under contract to CIRIA and cover the following topics: (1) the fundamental mechanisms of the corrosion of reinforcement in concrete in seawater, (2) the relationship between crack width and corrosion, (3) corrosion and fatigue of precracked reinforced concrete beams at 150-m depth in seawater and at the surface, (4) surveys of the condition of reinforced concrete in existing maritime structures, (5) the effect of temperature gradients on the walls of oil storage structures, (6) the strength of large prestressed members in shear, and (7) a study of the modes of failure of concrete platforms [4.9].

Table 4.5 summarizes the projects in Phase I and indicates that a number of confidential reports have been issued to the program participants. The five non-confidential reports, which are available to the general public, are described in Table 4.5.

The program was extended to Phase II in late 1979. The seven current projects and their scope are listed in Table 4.6.

4.3.3 Cement and Concrete Association

The Cement and Concrete Association is financed by the United Kingdom's six portland cement manufacturing companies. It is organized into six divisions: Research and Development, Advisory, Training, Information, Publishing, and Administrative Services.

TABLE 4.5 PHASE I OF UK CONCRETE
IN THE OCEANS PROGRAM

Project No.: 1
Title: FUNDAMENTAL MECHANISMS OF CORROSION OF STEEL REINFORCEMENT
IN CONCRETE IMMersed IN SEAWATER.
Contractor: Harwell Corrosion Center
Scope: Potential/time behavior, anodic and cathodic polarization
and corrosion currents are investigated under different
exposure conditions, including deep water (350m).
Reports: Confidential - Available Only to Sponsors
Part 1: Theoretical and experimental approach
Part 2: Experimental results and their significance
Part 3: The effects of concrete quality and of cracks in the concrete
on electro-chemical behavior

Project No.: 2
Title: DESIGNING AGAINST CORROSION IN OFFSHORE CONCRETE STRUCTURES
Part 1: Evaluating methods for design against excessive cracking
and examination of the relationship between corrosion and
design crack width.
Contractor: Cement and Concrete Association
Part 2: Influence of environment, stress, and materials on corrosion
of reinforcement in concrete.
Contractor: Wimpey Laboratories
Scope: Exposure tests to provide bases for improved design methods
against corrosion in concrete structures, and for the
inspection and maintenance of existing installations in the
North Sea.
Reports: Confidential - Available Only to Sponsors
o Interim Report to experimental work
Non-Confidential - Available from Cement and Concrete
Association
o "Cracking and Corrosion" by A. W. Beeby
Summary: This report summarizes the current state of knowledge on
crack control and the relation of cracking to corrosion in
order to provide information which may help in defining the
correct procedures for the control of corrosion in offshore
concrete gravity structures.

The various methods of controlling crack widths that have
been, or are likely to be, employed in the design of offshore
gravity structures are considered, and it is shown that the
influence on design of these various methods is very different.
Two basic approaches to crack control have been discerned.
The first of these, characterized by the "CEB Recommendations,"
is to require that cracks be controlled only at points on
the member surface directly over a main bar. The second
approach, characterized by the British CP110:1972 method,
requires that crack widths be limited at all points on the

TABLE 4.5 PHASE I OF UK CONCRETE
IN THE OCEANS PROGRAM (Continued)

surface of a member. Comparison of the various methods with test data suggests that the CP110 formula and the proposed new CEB formula give reasonable predictions of what they set out to predict but that the approach given in the 1970 "CEB Recommendations" is largely valueless.

An attempt has been made to gather together the existing data from exposure tests on cracked concrete members. In total, the six investigations described in the report give results from close to 500 specimens exposed for periods ranging from 2 to 15 years [4.10].

Project No.: 3
Title: EXPERIMENTAL INVESTIGATION OF THE EFFECTS OF TEMPERATURE GRADIENTS ON THE WALLS OF OIL STORAGE STRUCTURES
Contractor: Cement and Concrete Association
Scope: Several tests on 2-m deep portions of a wall 0.6 m thick subjected to cyclical temperature differences of up to 45°C.
Reports: Confidential - Available Only to Sponsors
 o Interim Reports 1, 2, and 3
 o Deformation Properties of an Oil Storage Vessel: Concrete Subjected to Fluctuating Stresses and Temperatures
 Non-Confidential - Available from Cement and Concrete Association
 o "Effects of Temperature Gradients on Walls of Oil Storage Structures" by J. L. Clarke and R. M. Symmons
Summary: The walls of undersea storage vessels are subjected to temperature differences across the faces of the order of 45°C, caused by cold sea water on one face and hot oil on the other. When the walls are restrained, this temperature difference may cause cracking. This report gives details of a test program carried out on seven specimens in a specially constructed test rig erected at the Cement and Concrete Association's research laboratories. The following variables were considered: steel percentage, level of prestress, temperature gradient, and cycle time. In parallel with the main investigation, an analytical method was developed and creep tests were carried out.

The report includes detailed results from all the specimens tested, results from the analytical work which are compared with the measured values, details of the creep data obtained, and limited information on relevant work carried out elsewhere. The work has shown that cracking due to local temperature effects is unlikely to be a problem under current operating conditions with a realistic level of draw down. It is

TABLE 4.5 PHASE I OF UK CONCRETE
IN THE OCEANS PROGRAM (Continued)

suggested that it may be possible to increase operating temperatures in future designs [4.10].

Project No.: 4
Title: SURVEY OF EXISTING REINFORCED CONCRETE MARINE STRUCTURES
Contractor: Taylor Woodrow Research Laboratories
Scope: Survey of a 35-year-old concrete fort to investigate degradation above and below the waterline, the penetration of chlorides, and the corrosion of the steel reinforcement.
Reports: Confidential - Available Only to Sponsors
o General Report for Phase I
o Tongue Sands Tower-Preliminary Study of the Pundit as a Surface Survey Instrument
o Investigation of Electrolytic Potential Techniques in Detecting Corrosion of Steel in Concrete Structures
o Marine Durability Survey of the Tongue Sands Tower-An Evaluation of Survey Procedures
Non-Confidential - Available from Cement and Concrete Association
o "Marine Durability Survey of the Tongue Sands Tower," by R. D. Browne
Summary: These reports present a detailed analysis of the non-destructive test measurements made and the results obtained from 150-mm-diameter cores and drillings taken from the 34-year-old Tongue Sands Tower, one of four old Naval Forts located at the mouth of the Thames estuary.

The analysis is presented in four sections:

- o Assessment of deterioration from visual survey records
- o Assessment of deterioration from the analysis of in situ nondestructive test results to determine concrete quality and extent of reinforcement corrosion
- o Assessment of deterioration from laboratory analysis of retrieved samples
- o Assessment of structural performance

The report also contains a detailed description of the inspection techniques developed and relates the importance of the findings to current offshore design and inspection [4.10].

Project No.: 5
Title: STRENGTH OF LARGE PRESTRESSED CONCRETE MEMBERS IN SHEAR
Contractor: Polytechnic of Central London
Scope: A series of tests on model elements of towers and caisson walls of offshore concrete structures containing realistic distributions of steel and prestress.

TABLE 4.5 PHASE I OF UK CONCRETE
IN THE OCEANS PROGRAM (Continued)

- Reports: Confidential ~ Available Only to Sponsors
- o Axial Tensile Tests of Reinforced Concrete
 - o Reinforced Concrete Deep Beams With Thin Webs
 - o Hollow Cylindrical Members in Combined Shear and Bending
- Non-Confidential ~ Available from Cement and Concrete Association
- o "Behavior of Concrete Caisson and Tower Members," by P. E. Regan and Y. D. Harnadi
- Summary: This report is divided into three parts and relates to the structural behaviour of two of the major elements of concrete gravity platforms - the walls of the caissons which rest on the sea bed and the towers which rise above them to support the production platforms.

Part 1 deals with "Reinforced concrete deep beams with thin webs" and concentrates on questions arising particularly in deep beams with flanges and stiffeners. There is little published information on this type of member. Part 2 on "Axial tensile tests of reinforced concrete" reports on tests designed to investigate the cracking of the tensile zones of large concrete members such as the towers of North Sea oil production platforms, while Part 3 on "Hollow cylindrical members in combined shear and bending" describes tests which were designed to provide information on such members and contains secondary information obtained on resistance to punching and on flexural behaviour at large rotations [4.10].

- Project No.: 6
- Title: FATIGUE STRENGTH OF REINFORCED AND PRESTRESSED CONCRETE IN SEAWATER
- Part 1: Corrosion fatigue of reinforcing steel in offshore structures
- Scope: A review of existing information
- Contractor: Cranfield Institute of Technology
- Part 2: Experimental program
- Contractor: John Laing Research and Development Limited
- Scope: Thirty reinforced beams tested to failure under a range of cyclic loading conditions at seawave frequency with some under hydrostatic pressure.
- Reports: Confidential ~ Available Only to Sponsors
- o Corrosion Fatigue of Reinforcing Steel in Offshore Structures - A Review of Existing Information
 - o Fatigue Strength of Reinforced Concrete in Seawater -- Part 1, Research Programme and Test Equipment

TABLE 4.5 PHASE I OF UK CONCRETE
IN THE OCEANS PROGRAM (Continued)

Project No.: 7
Title: MODES OF FAILURE OF CONCRETE PLATFORMS
Contractor: Ove Arup and Partners
Scope: A study of possible causes and modes of failure, including fire, impact, and foundation failure.
Reports: Non-Confidential - Available from Cement and Concrete Association
Summary: ○ "Modes of Failure of Concrete Platforms" by D. J. Dowrick
The report is essentially a state-of-the-art review in which an attempt has been made to identify those failure modes which were not well understood, or areas where previously unrecognized failure modes may exist. A definition of modes of failure is given, and failure risks are reviewed in relation to availability of data and probabilistic analysis.

Failure modes and effects were studied for a number of failure considerations including fire, ship impact, dropped objects, foundation displacements, earthquakes, gas explosions, and various stress states in the shafts and caissons of concrete platforms. Recommendations are made for research and design procedures for improving safety and serviceability [4.10].

TABLE 4.6 PHASE II OF UK CONCRETE
IN THE OCEANS PROGRAM

Project No.: 1

Title: CRACK AND CORROSION CRITERIA

Scope: To identify the fundamental conditions causing corrosion of steel reinforcement in concrete immersed in sea water by investigating the electrochemical behavior of the materials. The rate of penetration through concrete of the materials causing corrosion will be investigated, and the location of corrosion cells in marine structures will be identified so that more durable and economic structures can be designed. Exposure tests at Portland and Loch Linnhe will be continued to give experimental verification of the fundamental theories of corrosion.

Project No: 2

Title: IMPLOSION STRENGTH

Scope: To back up, with experimental evidence, the theoretical methods of designing concrete shell elements to resist combined loadings including high hydrostatic pressure.

Project No.: 3

Title: PUNCHING SHEAR AND IMPACT RESISTANCE

Scope: To extend and consolidate existing knowledge to promote the design of marine structures that are more resistant to accidental damage.

Project No.: 4

Title: TEMPERATURE GRADIENTS

Scope: To investigate the effects of temperature gradients on curved shell elements with various percentages of reinforcement.

Project No.: 5

Title: FATIGUE AND CORROSION FATIGUE

Scope: To extend the original Concrete in the Oceans corrosion fatigue investigation by further experimental and theoretical studies.

Project No.: 6

Title: SURVEY OF EXISTING STRUCTURES

Scope: To survey additional maritime concrete structures to provide long-term performance data.

Project No.: 7

Title: COORDINATING REPORT

Scope: To bring together the results of both Phase I and Phase II and to present them in a form which can be readily used by the designers and constructors of marine structures.

The Research and Development Division has five departments: Materials Research, Design Research, Construction Research, Operational Research, and the Development Unit. The research program is drawn up with the advice of three committees - Materials, Structures, and Construction - composed of leading engineers, architects, contractors and representatives of other research organizations, universities and closely allied industries. These committees also ensure liaison with all other organizations concerned with concrete research in Britain. Through its membership of international organizations concerned with concrete materials and construction, the Association maintains close contacts with those carrying out research in other countries. Table 4.7 shows the research areas of the Association.

Table 4.8 lists several specific research projects, ongoing in 1980 at the Cement and Concrete Association, which are most applicable to floating marine structures.

The Publishing Division is responsible for three of the Association's journals. The monthly Concrete has a wide-ranging content covering the subject in all its aspects and includes a rich cross-section of authors and contributors. It is the official journal of the Concrete Society. Precast Concrete, also monthly, provides up-to-date information on all aspects of precast concrete: materials, plant, manufacturing methods, and products. World Cement Technology, published eight times a year, is an international journal covering all aspects of portland cement manufacture from the quarrying of raw materials to the transporting of the finished product. The Division also publishes The Concrete Year Book, an annual reference guide to suppliers of concrete materials, services, equipment, and products available in the United Kingdom. The Publishing Division is responsible for the Viewpoint series of publications, established in 1976 as an imprint for works mainly by outside authors, and also acts as publisher for the Fédération Internationale de la Précontrainte and for many of the Concrete Society's publications. Several references directly applicable to floating structures are Concrete Afloat [4.12], Prestressed Concrete Ships First Report - Considerations for Design [4.13], Structural Lightweight - Aggregate Concrete for Marine and Offshore Applications [4.14], Recommendations for the Design and Construction on Concrete Sea Structures [4.15], and FIP State of the Art Report: Lightweight Aggregate Concrete for Marine Structures [4.16].

4.4 Netherlands Industrial Council for Oceanology (IRO) Program

The Netherlands Industrial Council for Oceanology, better known as IRO (Industriële Raad voor de Oceanologie), was formed as a foundation in May 1971 and is financially supported by industries whose interest is in offshore activities. IRO's primary task is to guide research collectively carried out by its members and others. Research funds are provided by the Ministry of Economic Affairs, but the study proposals generally come from within the industry. A Ministry representative sits in as a member of each study committee.

TABLE 4.7 RESEARCH AREAS OF THE CEMENT AND CONCRETE ASSOCIATION

1. Basic Materials
2. Fresh Concrete and Mortar
 - 2.1 Rheology of cement pastes, mortars, and concretes
 - 2.2 Constitution of fresh concrete
3. Properties of Hardened Concrete
 - 3.1 Early age properties
 - 3.2 Strength measurements and testing
 - 3.3 Dimensional change and movement
 - 3.4 Thermal properties
4. Construction Methods
 - 4.1 Formwork
5. Codes, Standards, Design Methods, and Management
6. Behavior of Concrete Elements
7. Concrete Block Masonry
8. Buildings
 - 8.1 Housing
 - 8.2 Floors
 - 8.3 General
9. Bridges
10. Pavements
11. Durability
12. Structures in Service



TABLE 4.8 RESEARCH PROGRAMS OF THE CEMENT AND CONCRETE ASSOCIATION
 APPLICABLE TO FLOATING MARINE STRUCTURES (FROM [4.11])

| <u>Project Reference Number</u> | <u>Title</u> | <u>Objective</u> |
|---|--|---|
| <u>1. BASIC MATERIALS</u> | | |
| M1.4 | Special concretes | To evaluate the performance of concretes modified by the inclusion of polymers, fibers, or other admixtures. |
| M1.5 | Blended cements | To establish acceptance criteria for pulverized fuel ashes which are suitable for blending with portland cement. To determine the effect of blended cement on the workability, strength, and durability of concrete. |
| <u>3. PROPERTIES OF HARDENED CONCRETE</u> | | |
| <u>3.1 Early age properties</u> | | |
| M3.1.3 | Strength development-temperature relationships | To determine the effect of temperature and change in temperature on the development of compressive strength and on the volume expansion of cement paste compacts during water curing. |
| M3.1.4 and C3.1.4 | Heat of hydration | To improve the prediction of temperature rises due to hydration and to provide design data for various concrete sections. |
| C3.1.5 | Strength of concrete in large pours | To study the difference in strength between concrete within a large pour subjected to an adiabatic temperature rise and concrete cured at normal temperatures. |
| <u>3.2 Strength measurement and testing</u> | | |
| C3.2.4 | In situ testing of concrete | To compare in situ methods of estimating concrete strength in structures and to define test methods, including the interpretation of results. |
| <u>3.3 Dimensional change and movement</u> | | |
| M3.3.3 | Prediction of movements in concrete | To undertake experiments that will improve prediction of the shrinkage and creep of structural concrete. |

(129)

TABLE 4.8 RESEARCH PROGRAMS OF THE CEMENT AND CONCRETE ASSOCIATION
 APPLICABLE TO FLOATING MARINE STRUCTURES (FROM [4.11]) (Continued)

| Project Reference Number | Title | Objective |
|---|------------------------|---|
| 4. <u>CONSTRUCTION METHODS</u> | | |
| 4.1 <u>Formwork</u> | | |
| C4.1.2 | Formwork pressures | To understand the mechanisms which determine the maximum concrete pressure on formwork. |
| 5. <u>CODES, STANDARDS, DESIGN METHODS AND MANAGEMENT</u> | | |
| D5.1 | Probability studies | To survey and evaluate current developments in the field of probabilistic design. |
| 6. <u>BEHAVIOR OF CONCRETE ELEMENTS</u> | | |
| D6.3 | Impact | To establish limits within which conventional static design methods can be used for impact loading on structural members, initially to study rate of loading on failure modes of beams. |
| D6.6 | Cracking in tension | To improve our knowledge of cracking and hence to rationalize its treatment in design. In particular, to provide information on cracking in large tension members with relatively widely spaced bars. |
| D6.8 | Temperature gradients | To determine the effect of temperature gradients and to investigate the cracking mechanisms involved in concrete cylinders. |
| D6.11 | Tunnel linings | To develop design methods for reinforcement in precast elements, adjacent to the dry knuckle joints. |
| 11. <u>DURABILITY</u> | | |
| M11.1 | Durability of concrete | (i) To study the dependence of durability on strength or cement content. |
| M11.2 | | (ii) To examine the durability of concrete containing cement ground with grinding aids. |
| D11.5 | Corrosion | To improve understanding of the corrosion of steel in concrete and, in particular, of its relation to cracking. |

In 1974 the IRO, together with the underwater technology division of the Royal Institution of Engineers and the Economic Affairs Ministry, set up the steering committee on problems associated with offshore structures known as StuPOC [4.17]. About 11 projects were conducted concerning the design, construction, and installation of jacket-type and gravity structures. Table 4.9 lists two StuPOC studies that were directly related to the use of concrete in the marine environment.

StuPOC proved the value of this type of research and led to the launching of the second program, Netherlands Marine Technological Research (MaTS). The MaTS programs, whose first phase began in 1978, gathers industry support, both technical and financial. So far, the MaTS program has initiated studies on 35 different subjects. The programs which deal with concrete in the ocean are listed in Table 4.9.

Although the IRO gets cooperation from other organizations concerned with concrete, welding, and materials, about 95 percent of the research work is performed at the TNO institutes in The Netherlands. Also involved are such organizations as the Delft Soil Mechanics Laboratory, the Delft Hydraulics Laboratory, and the Netherlands Ship Model Basin in Wageningen.

The MaTS programs are in various stages of completion, and the final reports will be published by The Netherlands Industrial Council for Oceanology. An increasing number of the reports will be available in the English language.

4.5 Norway

4.5.1 Det Norske Veritas (DnV)

The rapid development of offshore concrete structures has led to a variety of different designs. Of the 17 concrete gravity platforms in the North Sea, DnV has served as certifying authority or as consultants for 14.

In the United Kingdom Sector, DnV, engaged as the certifying authority, has issued certificates of fitness (valid for five years) to seven of the ten platforms on behalf of the UK Department of Energy. In the Norwegian Sector, the detailed evaluation and control of the offshore structures have been delegated by the Norwegian Petroleum Directorate (NDP), and DnV is active in this capacity. However, the formal approvals are issued by NDP.

Det norske Veritas is active both as a certifying and research organization in fixed and floating concrete structures. References 2.1 and 2.2 contain rules and guidelines for design, construction, and classification. DnV is a participant in the UK Concrete in the Oceans Program described in Section 4.3.2 and in the Norwegian/German COSMAR effort discussed in Section 4.5.3. In addition, DnV conducts a number of internally and externally sponsored confidential research projects which are briefly described in Table 4.10.

TABLE 4.9 PAST AND CURRENT NETHERLANDS MARINE TECHNOLOGICAL RESEARCH IN CONCRETE (FROM [4.16])

| <u>Project No.</u> | <u>Description</u> |
|------------------------|--|
| <u>StuPOC Projects</u> | |
| StuPOC-III-3 | <p><u>Fatigue of concrete</u> To obtain a better understanding of the behavior of plain concrete in compression under varying repeated stresses, constant-amplitude tests and programmed-stress tests were done to verify the Palmgren-Miner rule. Applicability of this rule for concrete gives the possibility of making reliable estimates of the lifetime of concrete loaded with irregularly varying compressive stresses.</p> |
| StuPOC-III-3-1 | <p><u>Fatigue of concrete, safety considerations</u> The main intention for the safety considerations associated with fatigue is to indicate a direction which the investigations should follow to set up a reliable probabilistic calculation of fatigue. These considerations are based on the experience and insight gained from the investigation of fatigue of concrete (StuPOC-III-3).</p> |
| <u>MATS Projects</u> | |
| BK-1 | <p><u>Fatigue of concrete structures</u> To obtain a better insight in the deterioration of reinforced concrete in a marine environment, preparations are made for research into</p> <ul style="list-style-type: none"> - stationary and nonstationary random stresses under compression - stationary and nonstationary random stresses under tension and bending forces. |
| BK-2 | <p><u>Inspection and monitoring methods</u> Methods will be investigated by which it will be possible to detect cracks in concrete and corrosion or fracture of steel reinforcement bars at inaccessible parts of offshore structures.</p> |
| BK-3 | <p><u>Repair and protection of concrete</u> A state-of-the-art report on underwater repair and protection of concrete will be prepared indicating those techniques which merit further research and development.</p> |
| BK-4 | <p><u>Influence of oil on concrete</u> Based on a literature review and interviews with industry, a proposal will be prepared for further investigation into possible harmful effects of oil and oil/seawater on reinforced concrete.</p> |



TABLE 4.9 PAST AND CURRENT NETHERLANDS MARINE TECHNOLOGICAL RESEARCH IN CONCRETE (FROM [4.16]) (Cont'd.)

| <u>Project No.</u> | <u>Description</u> |
|--------------------|--|
| BK-5 | <u>Influence of temperature changes on concrete</u> An inventory of available research in this field will be prepared. There is some question regarding the conclusions of French and British research on the magnitude of observed cracks. |
| BK-6 | <u>New materials for concrete</u> A state-of-the-art report will indicate the applicability of new materials to concrete structures. |
| BK-7 | <u>Concrete in the deep sea environment</u> Application of reinforced and prestressed concrete at depths greater than 100 m requires investigation of the behavior of concrete at such depths. A proposal for further research will be prepared. |
| BK-8 | <u>Stress-corrosion of prestressing steel wires</u> There is insufficient knowledge on this phenomenon, and a proposal for further research will be prepared. |
| ST-1 | <u>Dynamic behavior of offshore structures</u> Based on a review of available information, a proposal will be prepared for further research into: <ul style="list-style-type: none"> - Definition of actual loads on offshore structures - Relative importance of loads caused by different phenomena - Influence of damping effects on the dynamic behavior of offshore structures. |
| ST-2 | <u>Guidelines for deciding on the optimum configuration of a structure under predetermined conditions</u> Based on existing configurations and their environmental conditions, an optimization procedure for configurations at future locations with known environmental conditions will be developed. |
| ST-3 | <u>Probabilistic safety analysis for offshore structures</u> Developing and testing of a probabilistic safety analysis procedure for gravity and jacket structures, taking into account wave loads, own weight and deck loading, and foundation characteristics. |
| ST-4/5/6 | <u>Buckling and collapse calculations on floating, fixed, and gravity structures</u> State-of-the-art reports will be prepared on buckling and collapse research into steel and concrete shell structures. As a result, proposals for further research may be expected. |

TABLE 4.9 PAST AND CURRENT NETHERLANDS MARINE TECHNOLOGICAL
RESEARCH IN CONCRETE (FROM [4.16]) (Cont'd.)

| <u>Project No.</u> | <u>Description</u> |
|--------------------|--|
| ST-18 | <u>Nondestructive inspection of offshore structures</u> Development of NDT techniques for inspection during construction and monitoring of installed structures. |
| VM-2 | <u>Mathematical simulation methods for floating structures</u> The various phenomena will be listed, and the possibility of describing their effects in mathematical terms will be analyzed. Treatment of these aspects in existing simulation techniques will be reviewed, including restrictions. |

TABLE 4.10 RESEARCH PROGRAMS AT DET NORSKE VERITAS
APPLICABLE TO FLOATING MARINE STRUCTURES
(FROM [4.18])

TITLE: Computer Programming for Reinforced Concrete

OBJECTIVE: Develop a computer program (NLCON) for reinforced concrete based on the nonlinear behavior of the concrete in service and ultimate limit conditions. The program will be based on already existing nonlinear programs for reinforced concrete available within DnV.

TASKS: Theoretical evaluation, programming, testing, and reporting.

APPLICATION: Offshore

STATUS: Started in 1978 and planned to terminate in 1981. User's manual for NLCON is written. At present an extension of NLCON is being planned.

REPORTS: User's manual for NLCON.

SPONSORS: Det norske Veritas

CONFIDENTIALITY: No distribution without permission from the responsible department at Det norske Veritas.

TITLE: Shear Test on Concrete Plates

OBJECTIVE: Analyze the effect of water pressure in cracks on the shear capacity of concrete.

APPLICATION: The permanent high hydrostatic pressure acting on the offshore concrete structures will force fluid into cracks as soon as they start to develop. Together with combined loadings from moments, axial forces, and shear forces, the presence of high water pressure in cracks may significantly influence the ultimate shear capacity. Present designs do not adequately consider this. The present experimental work will supplement the current research work on ultimate shear capacity in offshore concrete structures.

STATUS: Test results are being reported.

REPORTS: Not yet published.

TABLE 4.10 RESEARCH PROGRAMS AT DET NORSKE VERITAS
APPLICABLE TO FLOATING MARINE STRUCTURES
(FROM [4.18]) (Cont'd.)

SPONSORS: Det norske Veritas.

CONFIDENTIALITY: No distribution without permission from the responsible department at DnV.

TITLE: Corrosion and Material Reliability of Offshore Concrete Structures

OBJECTIVE: Define relevant data on the behavior of reinforced concrete in the marine environment with respect to corrosion, i.e.,

- define the need for protection and the criteria for workmanship and design
- describe the material behavior of corrosion with respect to electrochemistry
- obtain a basis for inspection and methods of recording.

TASKS:

- (1) Field experiments
- (2) Laboratory experiments
- (3) Field exposure

APPLICATION: Defining the serviceability requirements and the corrosion hazards on offshore structures will result in final recommendations and criteria for various methods of protection systems. This will give a higher level of confidence in the safety of the offshore structures and reduce the maintenance cost.

STATUS: Seventy reinforced concrete specimens have been submerged in a fjord near Bergen, Norway. Precracks in the specimens vary from 0 to 0.5 mm, with covers of 20 mm and 50 mm.

Measurements recorded after one year of exposure in sea water indicate that the reinforced concrete specimens become nearly "passive," possibly due to:

- precipitation of CaCO_3 and Mg(OH)_2 from the alkaline environment into the concrete
- an organic layer covering the concrete surface
- eventual end of hydration

TABLE 4.10 RESEARCH PROGRAMS AT DET NORSKE VERITAS
APPLICABLE TO FLOATING MARINE STRUCTURES
(FROM [4.18]) (Cont'd.)

TITLE: Damage of Offshore Platforms - Analysis and Repair

OBJECTIVE: The primary objective is to classify types of damage to offshore concrete and steel platforms. Establishment of criteria concerning the necessity and quality of repair work is required to prevent progressive expansion of various types of damage. Further development of uniform methods for a systematic analysis of various types of damage and the study of the reliability of present repair work is necessary. Repaired damage on present platforms will be followed up in addition to model testing of simulated damage and repair work.

TASKS:

- (1) Study and pursue records of damage and repair on offshore concrete and steel platforms. Structures under similar environment and loading conditions will be examined so findings can be extrapolated to offshore conditions.
- (2) Develop methods for systematic and uniform analysis of present damage and associated consequences in order to classify damage and repair.
- (3) Study present methods of repair of offshore structures below the waterline.
- (4) Test quality and reliability of alternative methods of repair under simulated damage conditions on test models.
- (5) Establish a system of classification for registration of platform damage for future reference.
- (6) Establish criteria for acceptable size and type of damage and the resulting need for repair and control.

APPLICATION: Various types of damage have already occurred and more are likely to happen in the future. To have requirements for reliable repair and control, it is necessary to establish uniform methods of classification and analyses of damage. The choice of repairing damage may influence the future safety of the platform and prevent unnecessary breaks in production or inefficient methods of repair.

STATUS: Due to start in 1979 and terminate at the end of 1981.

SPONSORS: Royal Norwegian Council for Scientific and Technical Research (NTNF) and Det norske Veritas.

TABLE 4.10 RESEARCH PROGRAMS AT DET NORSKE VERITAS
APPLICABLE TO FLOATING MARINE STRUCTURES
(FROM [4.18]) (Cont'd.)

| | |
|------------|--|
| TITLE: | <u>Impacts and Collisions Offshore</u> |
| OBJECTIVE: | To obtain knowledge about: (i) The probability of impacts and collisions between fixed offshore structures and mobile vessels. (ii) The capacity of offshore structures against ship impacts. (iii) Design criteria for impact loads on steel and concrete offshore structures. |
| TASKS: | <ol style="list-style-type: none">1. Study of literature, with an overall survey of the available theory and experiments.2. The probability of collision - Apply various statistical methods to obtain the probability of collisions between an offshore structure and ship. The probability level will be related to various offshore structures, ships, offshore field locations, relative velocities, and various impact mechanisms. The statistical distributions will be related to existing data from the North Sea.3. Energy absorption/deformability of ships - Classify various types of impact mechanisms related to damage and consequences. Establish the energy absorption/deformation characteristics of the ships most likely to operate offshore. If necessary, perform static/dynamic testing.4. Impact capacity of concrete platforms - Theoretical investigation supported with model testing to obtain the capacity against impacts under service and ultimate conditions.5. Impact capacity of steel platforms - Theoretical investigation supported with experimental work to establish the serviceability and ultimate conditions against impact loads.6. Frequency of collisions and damage - A systematic recording of data from collisions and damages in the North Sea.7. Design criteria - Establish recommendations and design criteria against impact loads on offshore structures including various methods of protections. |

TABLE 4.10 RESEARCH PROGRAMS AT DET NORSKE VERITAS
APPLICABLE TO FLOATING MARINE STRUCTURES
(FROM [4.18]) (Cont'd.)

STATUS:

A study of offshore fender systems investigated the likelihood and nature of offshore collisions, their probability, and fendering efficiency. The work is presented in a report which gives recommendations for the protection of offshore structures, covering both design criteria and possible fender systems. See (1) below.

Alternative statistical methods of obtaining reliable probabilities for offshore collisions between platform/ship have been studied. For future work, a simulation technique will be preferred. See (2) below.

A pilot impact test on concrete cylinders has been performed, giving new and useful information for the benefit of further studies of the physical phenomena occurring during impact. Prior to the impact tests, the models had been used in another project at DnV, where they were tested to failure under hydrostatic pressure. See (3) below.

An analysis of the structural ship behavior under possible collisions with various types of offshore installations in the North Sea has been reported, including also the effect of eccentric impact against a ship's side and its superstructure. See (4) below.

REPORTS:

1. Offshore Fendersystems.
Collisions and Fendering Offshore, DnV Report No. 77-156
2. Impacts and Collisions Offshore.
Simulation Applied to Analysis of the Probability of Collision Between Ships and Offshore Structures.
Progress Report No. 1, DnV Report No. 78-037.
3. Impacts and Collisions Offshore.
Pilot Tests with Pendulum Impacts on Fendered/Unfendered Concrete Cylinders.
Progress Report No. 2. DnV Report No. 7-106.
4. Impacts and Collisions Offshore.
Impact and Energy Absorption of Ships (only in Norwegian).
Progress Report No. 4, DnV Report No. 78-433.
5. Impacts and Collisions Offshore.
Analysis of Penetration of Hulls.
Progress Report No. 4, DnV Report No. 78-433.

TABLE 4.10 RESEARCH PROGRAMS AT DET NORSKE VERITAS
APPLICABLE TO FLOATING MARINE STRUCTURES
(FROM [4.18]) (Cont'd.)

| | |
|------------------|--|
| | 6. Impacts and Collisions Offshore. Computer Simulation Analysis of the Collision Probability Offshore. Progress Report No. 5, DnV Report No. 78-624. |
| | 7. Impacts and Collisions Offshore. Computer Simulation Study of the Collision Probability Between Tanker/Platform. Progress Report No. 6, DnV Report No. 79-0192 |
| SPONSORS: | Royal Norwegian Council for Scientific and Technical Research (NTNF) and Det norske Veritas. |
| CONFIDENTIALITY: | No distribution without permission from the responsible department at Det norske Veritas. |
| TITLE: | <u>Reliability of Offshore Structures</u> |
| OBJECTIVE: | To assess available tools and data in order to recommend procedures for calibration of the rules for offshore concrete and steel structures. |
| TASK: | (1) Establishment of a data bank on accidents and failures of offshore structures. (2) A study of failure modes of offshore structures. (3) Development of a computer program to calculate the reliability of a system with multiple variables. (4) Calibration of the performance of a limited number of failure modes in order to evaluate the proposed process. Studies of the most suitable rule format for a probabilistic base. (5) Summary and recommendations. |
| APPLICATIONS: | Development of codes and rules for offshore concrete and steel structures. |
| STATUS: | Completed in 1979. |
| REPORTS: | Five reports have been completed and further reports are in progress. |
| SPONSORS: | Part of the project sponsored by the Norwegian Scientific Research Council. |
| CONFIDENTIALITY: | Unrestricted distribution. |



4.5.2 Norwegian Institute of Technology (NTH)/The Foundation of Scientific and Industrial Research (SINTEF)

4.5.2.1 Norwegian Institute of Technology

Over the years, the technical divisions at NTH have been active in research dealing with both steel and concrete structures. Much of the involvement is naturally directed offshore because of Norway's involvement in the North Sea oil exploration and production. Both the international conference on the Behavior of Offshore Structures (BOSS '76) [4.19] in 1976 and the symposium Concrete Structures [4.20] in 1978 were held at NTH.

The Division of Structural Mechanics at NTH is involved in the development of the theory and computer codes for nonlinear analysis of structures including concrete. Examples of such published research are given in references 4.21 - 4.24.

A joint effort is being conducted by Det norske Veritas and NTH to develop a finite element code called FENRIS (Finite Element of Nonlinear Reinforced Integrated Structures), which will supplement the DnV program SESAM. FENRIS will include both nonlinearities in geometry and material constitutive relationships. It will also consider static and dynamic loading and response.

NTH and SINTEF already have several programs for the linear and nonlinear analysis of concrete structures such as the North Sea platforms. Two codes CYLSHELL and CONSYM3 are briefly described below:

CYLSHELL [4.25] - A program for the static analysis of structures composed of an arbitrary system of cylindrical shells. The shells are assumed to be simply supported along the curved edges. Along the straight edge, which may have arbitrary boundary conditions, a particular shell may be connected to other shells, directly or via an edge beam.

The program can handle several kinds of loading: gravity load, loads parallel to local shell axes, temperature loads, and loads arising from prestressing. The loads may vary both in the axial and circumferential directions (described by Fourier expansions).

CONSYM3 [4.26] - For nonlinear analysis of axisymmetric concrete structures loaded axisymmetrically, structures may be modeled by both shell elements and solid elements. In the coupling of the two element types, the master-slave technique is used. Both cracking of the concrete and nonlinear stress-strain relations are included. Creep of concrete can also be taken into account. Prestressing is included and may be analyzed in several steps. The load history can be simulated by using load increments and independent load vectors.

NTH is not only active in structural analysis, but also conducts experimental programs in concrete material properties, corrosion of imbedded steels, and field surveys, [4.27-4.29]. Reference 4.27 is particularly interesting because it gives the results of a 5-year program to survey and report the durability of reinforced concrete wharves in Norwegian waters. Information on some 716 structures, some dating to 1910, was collected; 429 of these were slender-pillar quays. One-hundred seventy structures were selected for direct inspection. The objectives and main results are quoted below from reference 4.27:

The Specific Norwegian Problem

In Norwegian harbours, particularly in those of middle size, a steadily increasing proportion of wharves and piers during the last half century have been constructed as so-called "slender-pillar" reinforced concrete structures. This was due to the practice of concreting such pillars under water by the special tremie method introduced in Norway about 1910 by Mr. August Gundersen of the firm A/S Høyer-Ellefsen, Oslo. Combined with a simple system of prefabricating the wooden forms on shore and placing them with the reinforcement as complete units on foundations prepared in the sea bed, the method made such structures less costly than most other types of quays for relatively heavy traffic, provided the soil conditions were not too unfavourable. A particular advantage, especially in the older days, and also during the reconstruction after 1945, was that heavy equipment, like large barges, cranes and pile drivers could, if not readily available, be dispensed with.

Many engineers were doubtful about the pouring of concrete under water. Although apparently satisfactory performance of existing structures created increasing confidence, still one did not know what the realistic economic life expectancy for these quay structures would be.

The Concrete Committee of the Norwegian Society of Professional Engineers, appointed in 1926, primarily to investigate the concrete in dams and similar structures, therefore after 1930 extended its work to maritime structures, including also some slender-pillar wharves and piers. Mr. Kristen Friis, member of the present committee, was the secretary of the committee of 1926, who conducted the investigation and wrote the report. Due to lack of funds the scope of the investigation had to be rather restricted. Only a couple of structures were inspected under water. The general conclusions stated on page 30 of the report were nevertheless very interesting. All concrete which had been permanently submerged kept well. Damage occurs primarily in the tidal zone, particularly on lean concrete*

**Den Norske Ingeniørforenings Betongkomite', Meddelelse Nr. 3: "Betong i Sjøvann," Oslo 1936.*

and at construction joints. Leaving the wooden forms in place on pillars as well as on more massy structures was found to be advantageous. The beam and slab types of quay decks in many cases showed damage due to rusting of reinforcement, attributed to the concrete covering over the steel being too shallow. The use of structural steel frame as reinforcement and at the same time as support for the forms had proved inadvisable.

Altogether the investigation in the early 1930's gave the slender-pillar reinforced concrete quays only a somewhat qualified bill of health, except as regards the permanently submerged part of the pillars. Nevertheless the use of such structures continued to increase, as may be seen from Fig. 16 of the report* of Mr. Gjr, attached hereto.

Outside of Norway, however, this type of quay structures [sic] has hardly been used at all, and the method of concreting usual in Norway seems to be viewed with little confidence in other countries, as far as it is being considered at all.

Already in the middle of the 1950's the state of affairs described above made Norwegian engineers feel the need of a new investigation of our particular type of quay structures. If we had for some 50 years been using this type, it seemed to be high time that we ascertain beyond doubt what the result of such practice had been. The Nordic initiative mentioned above provided the incitement to get on with the job.

Main Results of the Investigation

The author of the present book has, in the opinion of the Committee, adequately and correctly stated the results of his investigation and the conclusions they justify.

Nevertheless, the Committee feels it expedient to emphasize briefly in this report some points which seem to be of special practical importance.

The purpose of the investigation was to detect and describe any damage inflicted until now on Norwegian reinforced concrete wharves and piers. Consequently the report in this book must dwell somewhat on such damage as has been found. This should not, however, obscure the most important overall result of the investigation, namely that on the whole the reinforced concrete wharves and piers have stood the test of time remarkably well, as seen from the diagrams of Fig. 170 a and b.

*See reference 4.27.

Remarkable is also [sic] the agreement between the conclusions drawn in the 1930's, summed up above, and those now arrived at: Below low tide level there is very little damage. In the tidal zone deterioration takes place, at a rate which is highly dependent on the quality of the concrete. Leaving the forms in place on pillars and walls gives effective protection. Corrosion of steel in the structure above high water level is a serious cause of damage, but even the oldest and the most seriously attacked structures are still in service, partly after some repairs.

The fact that the overall picture of the structures built before 1930 changed so little during the thirty-odd years from the first to the second investigation indicates that even where serious deterioration occurs, the process appears to be quite slow. The same conclusion is indicated by the apparently small effect of age of structures, as seen from Fig. 170 a and b.*

The results of the present investigation should definitely settle any doubt about the reliability of tremie poured underwater concrete in slender pillars. Most pillars (87%) were in good condition independently of age. Such damage as was found, was clearly attributable to deviations from the well known and simple rules of practice. Such deviations unfortunately occur in concreting, above as well as below water. In the latter case, the rules are in fact more clearcut and simpler to follow than in many cases of concreting above water.

The deplorable fact that even in 1960-65 serious defects in the under-water pillars of one structure was caused by faults in concreting, probably due to overconfidence in personal judgement, emphasizes the necessity of strictly following the accepted rules. The author's recommendations should be carefully noted.

As to the durability of pillars in the tidal zone, the importance of using high quality, frost resistant concrete should be emphasized. Still, the precaution of leaving pressure impregnated forms in place should be taken, as additional cost is very small.

The most vulnerable part of the usual quay structure definitely is the part above high water, especially the deck beams and slabs. Although the process of breaking down the bearing capacity of the decks seems to be very slow, as stated above, design and construction should aim at counteracting such development to the greatest possible extent. The results of the investigation and the discussion thereof indicate certain precautions which may well be briefly enumerated here:

*Figures 170a and b refer to figures found in reference 4.27.

- a. Use of high quality concrete with very low permeability and high frost resistance.
- b. Adequate and uniform thickness of the concrete covering the reinforcement.
- c. Leaving as much clearance as practical between the bottom of the beams and slabs and the high water level.
- d. Providing adequate horizontal support to prevent cracks opening due to impact of ships.
- e. Avoid serious overloading, for the same reason as d.

The results do not give basis for a definite choice between beam and slab versus flat slab decks. The data certainly indicate more extensive and more serious damage on beams than on slabs. Also the precautions enumerated above under a, b and c, can all somewhat more easily be taken care of with a flat slab deck, than with one of beams and slab. This is particularly true as regards point c, which is an important one.

In practice the choice will depend on what value will be placed on a longer economic life expectancy as against a minor saving in first cost.

Repairs of damage due to corrosion have been made in many cases, but durable results have not been attained. Repairs should be made under careful consideration not only of structural, but also of electrolytical and chemical relations, as discussed by the author.

4.5.2.2 The Foundation of Scientific and Industrial Research at the Norwegian Institute of Technology

SINTEF is a nonprofit organization performing research under contract to corporations, industrial associations, public service agencies, government departments, and other clients. SINTEF was established in 1950 as a free foundation by the action of the Norwegian Institute of Technology (NTH) in close cooperation with interested parties within Norwegian industry.

The Cement and Concrete Research Institute (FCB) is an affiliated institute in SINTEF and conducts a variety of programs dealing with concrete. Examples of research concerned with marine concrete structures include:

- o Quality characteristics of cement
- o Impact loads on concrete shells
- o Concrete exposed to high water pressure
- o Characterization of structure in hardened concrete

- o Evaluation and control of steel corrosion in concrete
- o Sulphate resistance of cement
- o Effects of temperature.

FCB is engaged in a program called "Concrete Ships in Norway." It is a survey of four concrete ships which are 35-60 years old. The scope of work includes an evaluation of the concrete and a review of the designs. This study is jointly funded by the Norwegian Council for Scientific and Industrial Research (NTFT) and private organizations. As such, any results are presently confidential. However, some information concerning the ships surveyed is reported below:

Vessel No. 1: Dredger
 Built: 1945
 Service: Still operational
 Construction: Ordinary reinforced concrete (Outer shell 90 mm thick, inner walls 60 - 70 mm thick, deck 100 mm thick)

Vessel No. 2: Coal and Sand Barge
 Size: 10 m wide, 56 m long, 6 m deep
 Built: 1918 in England
 Service: Stranded in Norway in 1942
 Construction: Prefabricated panels 60 mm thick

Vessel No. 3: Description unknown
 Size: 4.5 m wide, 16 m long, 2.5 m deep
 Built: About 1919
 Service: 40 or 50 years
 Construction: Used sprayed concrete and constructed as a wooden vessel with double curvature
 Status: Damaged by ice, and reinforcements in damaged area are corroded. Owner would like to repair, but method of repair is uncertain.

Vessel No. 4: Description unknown
 Built: During World War I
 Service: 15 or 20 years
 Construction: Similar to Vessel No. 3
 Status: Particular interest in this vessel because it has been subjected to Arctic conditions for the past 35 or 40 years.

CEB is also a participant in the Norwegian/German COSMAR Program, which is discussed in the next section.

4.5.3 Norwegian/German COSMAR Program

The Norwegian/German COSMAR Program (Concrete Structures for Marine Prediction, Storage and Transportation of Hydrocarbons) is a large, international research effort dealing with concrete structures in the marine environment. The four projects include:



- (1) Investigation of offshore concrete structures with respect to static strength.
- (2) Investigation of offshore concrete structures with respect to fatigue strength.
- (3) Development of concrete structures for storage and transportation of LNG and oil, including thermal effects.
- (4) Concrete offshore structures subjected to ice and Arctic conditions.

The participants originally consisted of West German and Norwegian groups which included:

German Group

Dyckerhoff and Widmann, Munich
 Bilfinger und Berger, Mannheim
 Hochtief, Essen
 Philipp Holzmann, Hamburg
 Meerestechnik und Seebau, Hamburg
 Hamburgische Schiffbau
 Versuchsanstalt, Hamburg

Norwegian Group

Det norske Veritas, Oslo
 Cement and Concrete
 Research Institute, Trondheim
 Norsk Hydro, Oslo
 Norwegian Contractors, Oslo
 Den Norske Stats, Stavanger
 Exxon Production Research
 Company, Houston
 Mobil Research and
 Development Corporation,
 Dallas
 Shell International Petroleum,
 The Hague, Netherlands

Later participants include the United Kingdom Department of Energy and Mitsui in Japan. COSMAR is also supported by the European Communities, the West German Bundesministerium fur Forschung und Technologie, and the Royal Norwegian Council for Scientific and Industrial Research.

Table 4.11 gives the objectives and status of each project. The COSMAR program was scheduled to end at the middle of 1981, with the results being confidential to the program participants.

4.6 Treat Island, Maine, Concrete Exposure Station

4.6.1 Description of the Test Facility

Since the placement of the first specimens in 1936, the Treat Island, Maine, exposure station has been used for studies on the natural weathering of concrete and concreting materials. The severe weathering station presently consists of a wooden exposure rack 37 m x 12 m (120 ft x 40 ft) and a portion of beach 61 m (200 ft) long. The station is exposed to a twice daily 5.5-m (18-ft) tide and to severe winters. Specimens are installed at mean-tide elevation, and the alternate conditions of immersion of the specimens in sea water, then exposure to cold air, provide

TABLE 4.11 NORWEGIAN/GERMAN COSMAR PROGRAM
(FROM [4.18])

PROJECT NO: 1

TITLE: Investigation of Offshore Concrete Structures With Respect to Static Strength

PROJECT LEADER: Cement and Concrete Research Institute, Trondheim

OBJECTIVE: To obtain knowledge required to determine the ultimate load-carrying capacity of complex reinforced and prestressed concrete structures composed of shells, plates, frames, etc., for load combinations typical for offshore structures. Further, to develop procedures which can be used for design of more demanding structures than those being designed today.

STATUS: A pilot test on four concrete shell models has been performed by DnV, investigating the intersection of a dome and cylinder, implosion due to excessive hoop compressive stresses in the cylinder walls, and the reliability of tests carried out at the fairly small scale of approximately 1:10. The project plans to concentrate its effect on the concrete strengths with respect to shear, materials, and implosion.

PROJECT NO.: 2

TITLE: Investigation of Offshore Concrete Structures with Respect to Fatigue Strength

PROJECT LEADER: Det norske Veritas, Oslo

OBJECTIVE: To obtain improved information on the fatigue strength of concrete under hydrostatic pressure, in order to promote development of reinforced concrete structures exposed to a marine environment. The fatigue compressive strength of reinforced concrete will be investigated, including the effects of external hydrostatic water pressure, frequency of loading, different strain gradients, cumulative damage, and cracked or uncracked sections.

STATUS: Pilot testing of 14 reinforced concrete specimens was planned and executed at DnV in the period 1975-1976.

TABLE 4.11 NORWEGIAN/GERMAN COSMAR PROGRAM
(FROM [4.18]) (Cont'd)

PROJECT NO: 3

TITLE: Development of Concrete Structures for Storage, and Transportation of LNG and Oil Including Thermal Effects

PROJECT LEADER: Dyckerhoff und Widmann, Munich

OBJECTIVE: To develop and construct reinforced and prestressed concrete structures in the offshore area for the production, storage and transportation of LNG and oil, detailed knowledge of the characteristics of concrete and reinforcement under the effect of LNG and oil is necessary. It may well be necessary to develop special concretes with the required properties, considering the process of manufacture and the final product subject to offshore environment and its particular use. In addition, it will include a study of thermal structural effects. The influence of differences in temperature and the resulting stresses and forces are of special interest.

STATUS: Planned to terminate by the middle of 1981.

PROJECT NO.: 4

TITLE: Concrete Offshore Structures Subject to Ice and Arctic Conditions

PROJECT LEADER: Bilfinger und Berger, Mannheim

OBJECTIVE: Study the external load developed by floating ice on concrete structures and the surface behavior of concrete interacting with ice (abrasion and durability) in order to arrive at new proposals for offshore structures suitable for the production, storage, and transportation of oil and gas in Arctic waters. Feasible concrete structures will be selected for intensive theoretical and experimental investigation of forces from drifting plate ice, pack ice, and ridges.

STATUS: Planned to terminate by the middle of 1981.

numerous cycles of freezing and thawing of the concrete during the winter. During an average winter, the specimens are subjected to over 100 cycles of freezing and thawing [4.30].

All exposed specimens are inspected visually by the resident contractor each week during the period that freezing and thawing cycles occur, usually October through March. The condition of each specimen is recorded on an inspection form which is forwarded to the Structures Laboratory, U.S. Army Corps of Engineers Waterways Experiment Station (WES), along with the time-temperature history for that week. During the summer of each year, an inspection and testing team from the WES visits the exposure station for the purpose of performing the annual inspection and testing of all specimens by visual and other nondestructive methods. During this annual visit, photographs are taken of all programs in progress, with special emphasis on programs of particular interest at the time and any specimens exhibiting significant or inordinate deterioration [4.30].

In addition to visual observation, for those specimens whose shape, size, and condition permit, the resonant frequency of the test items is determined. From this testing, the dynamic Young's modulus of elasticity is determined and used as a measure of the deterioration of the specimen. The specimens are also subjected to pulse velocity tests which can be related to the dynamic Young's modulus of elasticity. Specimens are regarded as having failed when they separate into pieces, when the percent Young's modulus relative to the original value is 50 or less, or when deterioration has progressed to such a point that reliable determination of fundamental frequency and pulse velocity cannot be obtained. Specimens that have been broken in handling are so listed and are not classified as "failed" [4.30].

4.6.2 Past Research

Specimens of various sizes and shapes have been used from time to time in the outdoor exposure tests. There have been spheres, cylinders, cubes, prisms, and beams varying in weight between 2 and 454 kg (5 and 1000 lb). Some 600, 89 x 114 x 406 mm (3.5 x 4.5 x 16 in.) concrete beams with aggregate sizes up to 19 mm (0.75 in.) have been exposed and tested. A composite of about 1450, 152 x 152 x 762 mm (6 x 6 x 30 in.), 152 x 152 x 914 mm (6 x 6 x 36 in.), and 152 x 152 x 1219 mm (6 x 6 x 48 in.) prisms with aggregate sizes up to 38 mm (1.5 in.) have been exposed. Some 610-mm (24-in.) cubes representing concrete mixtures, containing 152-mm (6-in.) maximum size aggregate, have been exposed. However, in 1963 it was decided that specimens for outdoor exposure of mass concrete mixtures would be 457 mm (18 in.) in height and depth, and 914 mm (36 in.) in length. The 457 x 457 x 914 mm (18 x 18 x 36 in.) prism was selected instead of a 610-mm (24-in.) cube because it (a) afforded a longer path length for pulse velocity readings, (b) contained less concrete and therefore weighed less, and (c) was more amenable to tests for fundamental transverse frequency. In 1968, with the 457 x 457 x 914 mm (18 x 18 x 36 in.) prisms as the standard outdoor exposure specimen and with enough exposure rack space available for the proper installation of a large number of prisms on their nodal points, large mass concrete specimens were tested for both fundamental flexural frequency and pulse velocity on a regular basis for the first time at Treat Island, Maine [4.30].

150

Exposure data are updated annually, giving Corps of Engineer Engineering, Construction, and Operations Divisions information on the relative ability of various concretes and concreting materials to withstand weathering. Reports describe the exposure stations, test methods used, the specimens, and list test results to date. The results of various investigations which include severe weathering durability and performance have been reported over the years. The analysis of data collected over the years on selected research programs has been initiated in preparation for reporting significant developments related to long-term exposure of concrete to severe weathering.

4.6.3 Study of Reinforced Beams at Treat Island

A study was begun in 1950 to determine the effects of severe natural weathering on stressed, reinforced concrete beams of various compositions and degrees of stress. The objective of the study was to obtain information on the long-term weathering of air-entrained and non-air-entrained concrete beams containing steels of different compositions, types of deformation, and different levels of stress.

A series of 82 beams was fabricated. These beams contained a number of variables that might affect the durability of the concrete and the steel used as reinforcement. Eighteen of the 82 beams were made with air-entrained concrete; the rest were made from a similar mixture without air entrainment to evaluate the desirability of air entrainment in severe environments. Thirty-nine percent of the beams were cast with 50-mm cover over the reinforcement, while the remaining beams had 19-mm cover to evaluate depth of cover. The reinforcing steel in the 82 beams conformed to ASTM Designation A 16-50T for "Rail-Steel Bars for Concrete Reinforcement," or to Designation A 15-50T for "Billet-Steel Bars for Concrete Reinforcement," intermediate grade. The billet-steel bars conformed to ASTM Designation A 305-50T for "Minimum Requirements for the Deformations of Deformed Steel Bars for Concrete Reinforcement." Some of the rail-steel bars had deformations conforming to ASTM Designation A 305-50T, and the others had old-style deformations that did not meet these requirements. The different types of steel and types of bar deformations were used to evaluate the resistance to deterioration of rail steel versus billet steel and to see if old-style deformations or ASTM Designation A 305 type deformations provided better pullout resistance. Thirty-three percent of the beams were cast in an inverted position with their steel reinforcement in the top of the form, and the rest were cast in the upright position with the steel in the bottom of the forms. This was done to determine if the steel cast in the bottom of the beam would weather better than steel cast in the top, due to greater amounts of cement segregation at the bottom of the beam during casting. All the beams, with the exception of the control beams, were loaded to put the tensile steel under stress. Beams requiring the same amount of load were yoked together in three-point flexural loading. The beams were loaded such that the various levels of stress in the steel were 0, 138, 207, 276, and 345 MPa [4.31].

The beams were placed on the beach at the natural weathering exposure station on the south side of Treat Island, where they were subjected to twice-daily tidal cycles and, during the winter months, to cycles of freezing and thawing. Annual inspections were performed during

the exposure period and the results evaluated by a team of inspectors rating the degree of deterioration. Maximum crack widths were measured each year from 1956 to 1975, when the exposure period was concluded.

Sixty of the 82 beams in this series were nonair-entrained beams. Since all of these beams deteriorated to a point of total failure within five years after initiation of testing, some of the variables were eliminated because of failure of the specimens and lack of parameters for comparison. The nonair-entrained beams contained all the billet-steel reinforcing bars, all the bars that were protected by 50 mm of cover, and all the reinforcing bars that had old-style deformations; consequently, all these variables were lost when the nonair-entrained beams failed. The variables remaining subsequent to January 1956 which could be compared were the degree of stress in the reinforcing steel, the amount of corrosion to the bar, and the effect of casting the reinforcement in the top or bottom of the beam [4.31].

At the conclusion of the exposure period in December 1975, 13 of the 18 air-entrained beams were still in testable conditions. Eleven of these 13 beams were returned to the WES for structural testing and autopsy to evaluate the condition of the beams after 25 years of exposure. A typical beam as it was received in the laboratory is shown in Figure 4.1. Seven of the 11 beams were tested to failure in three-point flexural loading. All the beams failed in diagonal tension, with six of the failures initiated by pullout of the reinforcement from the concrete at the end experiencing the diagonal tension failure. The results of the testing are given in Table 4.12. No definite relationship can be drawn from the data with respect to ultimate moment and stress level. However, it can be stated that the ultimate moments were not reduced below design levels over the 25-year period due to level of stress, corrosion of the reinforcement, or loss of bond length from spalling except in the control beam [4.31].

An additional parameter was added to the evaluation of the exposure tests. This was the relation of crack width to the amount of corrosion on the steel. Also, the loss of cross-sectional areas of steel and chloride content determination tests were added to the testing program. As a general remark, the steel beneath the 19-mm cover was not heavily rusted. There were areas that did receive corrosion where the concrete cover was still intact, such as the tips of the reinforcing bars. But on the whole, areas where the bars were not directly exposed to oxygen and sea water remained only lightly rusted. Where the concrete cover had spalled, the steel was heavily rusted from direct exposure to the harsh environment [4.31].

The data gathered by the teams of observers on the measurements of crack widths over the period 1957 through 1975 indicate an increase in crack width with respect to both length of time under load and level of stress applied to the reinforcement. It was observed that there was more corrosion on the bars at the higher stress levels. This was due to the larger crack widths and the greater exposure to oxygen and sea water. Also, the results of the chloride content tests revealed concentrations of chlorides ranging from 0.12 to 0.70 percent by weight of concrete sample, a chloride concentration high enough to severely reduce the passivating

152

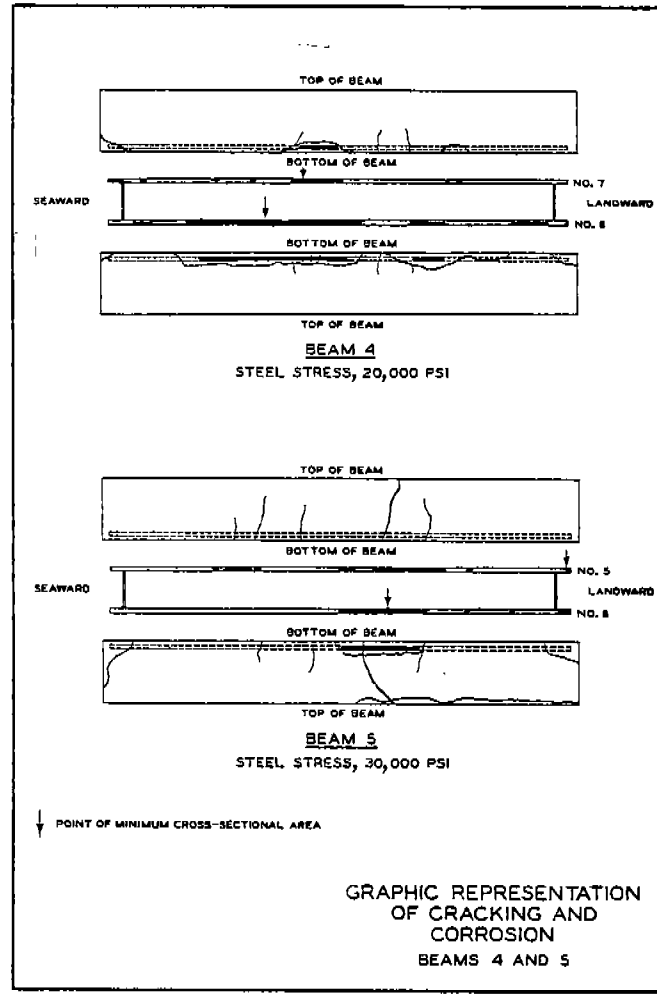

FIGURE 4.1 GRAPHIC REPRESENTATION OF CRACKING AND CORROSION--
BEAMS 4 AND 5 (FROM [4.31])

TABLE 4.12 ULTIMATE LOAD PROPERTIES OF BEAMS TESTED IN FLEXURE
(FROM [4.31])

| Beam No. | Stress Level, MPa | Stress Position | Failure Load, kN | Midspan Deflection, mm | Moment Developed at Ultimate Load, N·m | Design Ultimate Moment N·m | Ratio $\frac{M'_u \text{ Actual}}{M'_u \text{ Design}}$ |
|----------|-------------------|-----------------|------------------|------------------------|--|----------------------------|---|
| 2 | 138 | Top | 177 | 11.2 | 63,696 | 58,748 | 1.084 |
| 4 | 138 | Bottom | 169 | 13.1 | 60,795 | 58,748 | 1.035 |
| 5 | 207 | Top | 154 | 20.1 | 55,521 | 45,664 | 1.216 |
| 7 | 207 | Bottom | 127 | 20.3 | 45,759 | 45,664 | 1.002 |
| 8 | 207 | Bottom | 168 | 12.4 | 60,469 | 45,664 | 1.324 |
| 12 | 276 | Bottom | 150 | 40.8 | 53,989 | 30,791 | 1.753 |
| 18 | Unstressed | Bottom | 137 | 6.1 | 49,270 | 58,748 | 0.839 |

coating on the reinforcing steel. However, no relationship between stress level and loss of cross-sectional area due to corrosion could be established. This was because the control beam, under no steel stress, had a cross-sectional area reduction of 33 percent, which was the second largest reduction observed. With respect to stress level and corrosion to the steel, it appears that they are not related except through the fact that the higher stress levels produced larger crack widths, which allowed greater influx of the corrosive environment [4.31].

4.6.4 Current Research at Treat Island

There are 36 active programs concerned with natural weathering at Treat Island. They include areas of investigation such as prestressed concrete, fiber concrete, polymer concrete, sulfur-infiltrated concrete, and superplasticizers. Specimens currently installed at Treat Island include those from the U.S. Water and Power Resources Service; the Canadian Department of Energy, Mines, and Resources; the U.S. Corps of Engineers Waterways Experiment Station; and many other civil engineering projects [4.6].

Many Corps offices are using some of the more exotic concretes such as fiber-reinforced concrete without adequate knowledge of the properties, especially as they affect quality in hydraulic structures. Investigations pertaining to strength, durability, erosion and cavitation resistance, corrosion, and long-time durability need to be undertaken. In January 1975, 30 concrete beams (89 by 114 by 406 mm) which formed a part of the Civil Engineering Research Laboratory (CERL) Fibrous Concrete Program were installed at half-tide elevation on the exposure rack at Treat Island, Maine, to determine the effects of the sea water and the freezing and thawing action on the flexural strength and other properties of various fiber concretes. Half the beams were cracked prior to testing. These beams were exposed until July 1976, at which time 20 beams were returned to CERL for laboratory tests. The remaining 10 beams are still under exposure. Under a second program initiated in July 1975, 50 concrete beams, a part of the WES Fibrous Concrete Program, were installed on the exposure rack at Treat Island. The number and types of beams exposed are: twelve, 152 by 152 by 762 mm; twenty-one, 152 by 152 by 914 mm; and seventeen, 229 by 229 by 1143 mm. The 229- by 229- by 1143-mm beams are yoked and stressed by three-point loadings to working loads of 35 percent of ultimate. Exposure of these beams is continuing. They are inspected and tested each year, and the loads are checked and adjusted if necessary. So far, sufficient deterioration has not occurred to draw definite conclusions [4.6].

Polymers are being used in concrete in the field for both restoration and new construction. Little is known, however, about the characteristics of the polymer-concrete composites and the proper manner in which they are to be applied and used. Attempts to use them occur

routinely, however. To resolve this problem, research on developing the necessary information for implementation in the field of polymer-impregnated concrete, polymer or resin concrete (no cement), or polymer portland-cement concrete (latex type) is needed. A program was installed in July 1978 for the Water and Power Resources Service (formerly U.S. Bureau of Reclamation) for the purpose of investigating the durability and performance of polymer and polymer-impregnated concrete. The polymer concrete specimens represent two mixtures, one using methyl methacrylate (MMA) and one using vinyl ester. The polymer-impregnated specimens are portland-cement concrete that were impregnated with MMA by vacuum and pressure soak. The program also includes control specimens of portland-cement concrete with no treatment [4.6].

In July 1977, six roller-compacted concrete beams representing two mixtures were installed on the Treat Island exposure rack for the North Pacific Division Materials Laboratory. The two mixtures were considered as interior and exterior mixes and were designed and tested for Zintel Canyon Optimum Gravity Dam (Walla Walla District), Kennewick, Washington. These specimens were almost completely disintegrated after one winter of exposure [4.6].

In January 1976, the Canada Centre for Mineral and Energy Technology received permission from the Office, Chief of Engineers, to install specimens of sulfur-infiltrated concrete at the Treat Island Exposure Station. In August 1976, 54 sulfur-infiltrated concrete specimens were installed at half-tide elevation on the exposure rack. The cylinders were made from nine different concrete mixtures that included air-entrained and nonair-entrained concrete. In July 1977, 15 sulfur-infiltrated precast concrete elements were installed as additions to the program. This program is still underway [4.6].

High-range water-reducing admixtures have recently been developed which permit as much as 25 percent water reduction in a concrete mixture, resulting in approximately an increase of 40 percent in 28-day compressive strength at the same cement content when placed at the same slump. Some tests have shown that the resulting concrete has a deficient air-void system and consequent inadequate resistance to freezing and thawing. Also, there has been discussion of the possibility of using the slag and fly ash produced in a particular area in the construction of marine structures. In the fall of 1978, a Canadian program including 102 concrete cylinders and 36 prisms was installed to investigate the effect of cement replacement with slag and the effect of high-range water reducers on the performance of concrete in severe weathering environments. Some of the variables include three water-cement ratios, two types of portland cement (with and without slag replacement), air and nonair-entrainment, and two high-range water reducers [4.6].

Future plans are to include more specimens, the evaluations of which can contribute to the Corps' knowledge of various concreting

materials' relative resistance to such severe weathering conditions. Another area requiring much work is to correlate the Treat Island results with in situ concrete structures; in the past, many of the results reported on could be visually determined by inspection; in the future, a greater in-depth analysis will need to be developed so that the contribution of all of the parameters, including concrete constituent properties to deterioration, may be analyzed [4.6].

4.7 Civil Engineering Laboratory, Port Hueneme, California

4.7.1 Introduction

The Civil Engineering Laboratory, Naval Construction Battalion Center, at Port Hueneme, California, has been involved in a number of research programs concerned with the use of concrete in the marine environment. One area has been the development of analytical methods for the design of cylinders and spheres subjected to hydrostatic loads. The aim has been to develop such methods and verify the results with experiments. The early research was concerned with spherical structures. Later studies also considered concrete cylinder structures under hydrostatic load.

4.7.2 Spherical Structure

The experimental work on spheres has been restricted to thick-walled spheres whose failure is determined by the implosive strength and the compressive strength of the concrete. Thin-walled spheres are limited by buckling of the spheres. Experimental specimens have been (1) 16-in. outside diameter (OD) spheres with a wall thickness (t) to OD (D_o) ratio from 0.062 to 0.25, and (2) 66-in. OD spheres with a 4.12-in. wall thickness ($t/D_o = 0.062$). The smaller spheres were constructed using a concrete mix with a water-to-cement ratio from 0.56 to 0.65 and an aggregate to cement ratio of 3.30, resulting in concrete strengths from 6000 to 11,000 psi.

The larger diameter spheres were primarily designed for long-term exposure tests to real environmental conditions. The objectives of the program were to obtain data on the time-dependent failure, permeability, and durability of the concrete spherical structures. The 18 spheres were placed in the ocean at depths varying from 560 to 1550 m (1840 to 5075 ft). Sixteen of the spheres were unreinforced concrete, eight of which were coated on the exterior with a phenolic compound to act as a waterproofing agent; the other eight spheres were left uncoated. The remaining two spheres were lightly reinforced with 13-mm (0.5-in.) diameter steel bars. The concrete design was Type II portland cement, a water-to-cement ratio of 0.41, a sand-to-cement ratio of 1.86, and a coarse aggregate-to-cement ratio of 2.28. The depth range of the spheres corresponded to a relative load level of 0.36 to 0.83. The relative load level, P_s/P_{im} , is defined as the ratio of the sustained pressure to predicted short-term implosion pressure. Periodically during the exposure period, 1971

156

to 1978, the condition of the spheres was determined by the use of a submersible. In March of 1978, the spheres were retrieved for future inspection. Surface inspection of the spheres revealed tube worms and a grass-like animal growth on the coated spheres, as well as a few small anemones and a grouping of small scallops. The concrete surfaces, whether coated or uncoated, had considerably less grass-like growth than the steel chains. These spheres were subsequently tested in the laboratory where they provided data on the actual quantity of water permeating to the inside of the spheres, the short-term implosion pressure and strain behavior of preloaded spheres, and the chemical compounds present in the concrete [4.32, 4.33].

The design equation for thick-walled sphere implosion is from [4.34]:

$$P_{ULS} = \frac{\lambda}{\gamma_{mc} \gamma_f} \left[K f'_c \left(1 - \left(1 - \frac{2t}{D_o} \right)^2 \right) \right] \quad (4.1)$$

where

P_{ULS} = ultimate limit state pressure

λ = long-term loading factor

γ_{mc} = partial material factor for concrete

γ_f = partial load factor

f'_c = uniaxial compressive strength of 6 in. x 12 in. concrete control cylinder

K = strength increase factor.

The strength increase factor is given by

$$K = 1.22 + 0.014 \exp (13.5 t/D_o) \quad (4.2)$$

which was a curve fit of experimental data (Figure 4.2). In addition to implosion, the design must consider in-plane cracking which is initiated on the inner surface where the material is under biaxial loading and not confined by triaxial stresses as in other locations. The pressure at initiation, P_{p1} , is given by [4.34]

$$P_{p1} = 0.9 f'_c \left[1 - \left(1 - \frac{2t}{D_o} \right)^3 \right] \quad (4.3)$$

for

$$\frac{t}{D_o} \geq 0.10$$



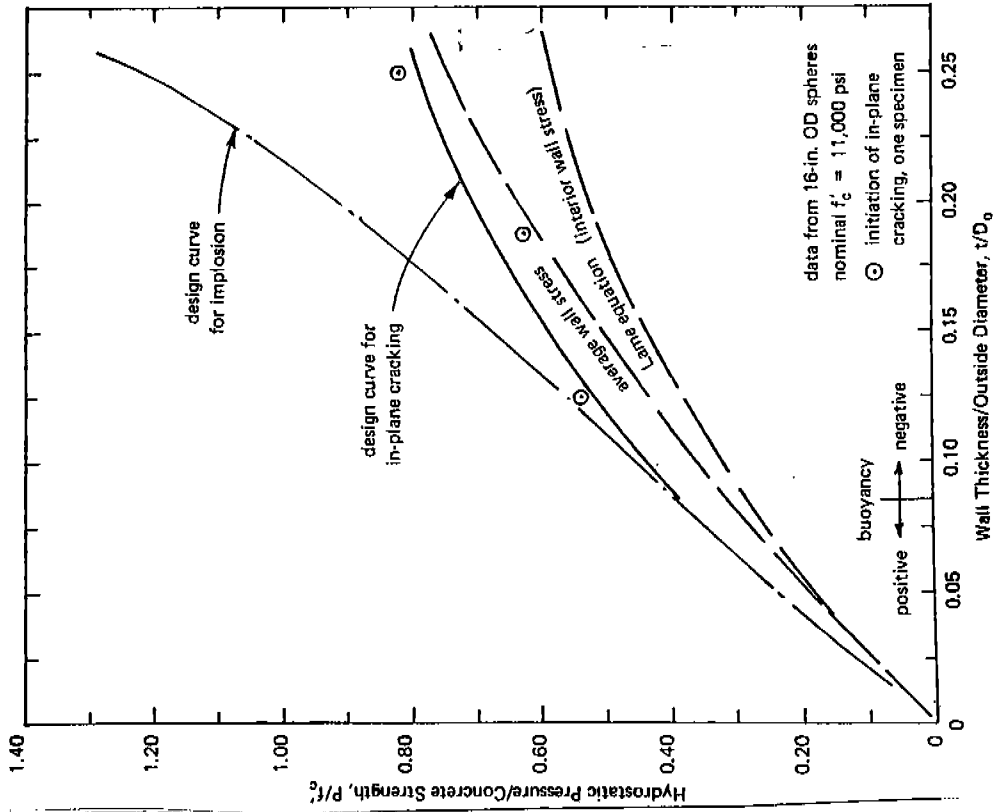

FIGURE 4.3 IN-PLANE CRACKING OF THICK-WALLED NEGATIVELY BUOYANT SPHERES (FROM [4.33])

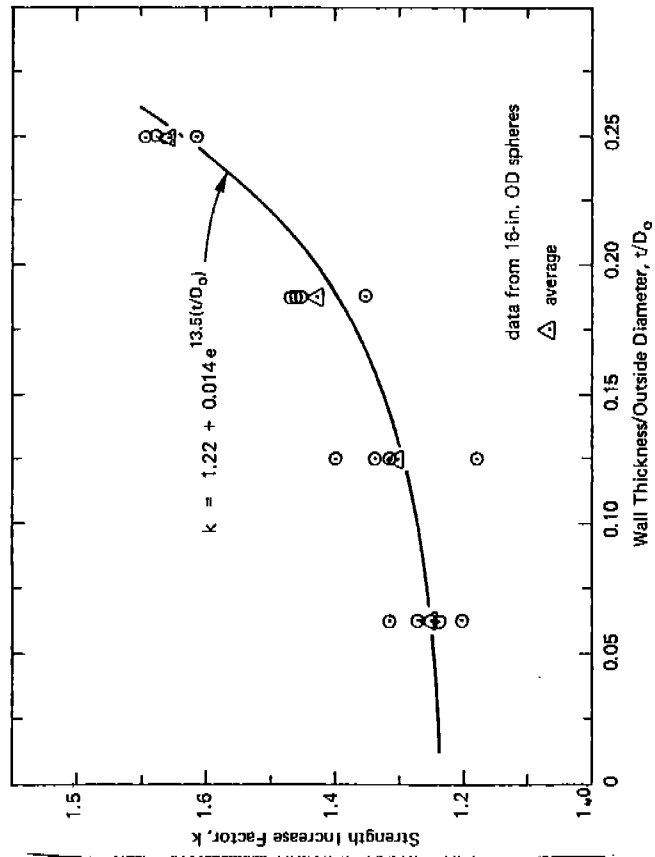

FIGURE 4.2 STRENGTH INCREASE OF CONCRETE IN SPHERICAL STRUCTURES (FROM [4.33])

Experimental results (Figure 4.3) seem to verify the formulation.

The results of the test program on spherical shells at the Civil Engineering Laboratory are summarized from reference 4.33.

1. Concrete that was placed in the ocean decreased in compressive strength by at least 10 percent due to saturation. A time period of from 1 to 2 years in the ocean was required to regain a strength equal to that of the 28-day fog-cured strength (Figure 4.4).
2. After 5.3 years in the ocean, concrete showed a compressive strength that was 15 percent greater than its 28-day fog-cured strength. However, this strength was still 15 percent less than companion concrete continuously fog-cured (Figure 4.4).
3. Three spheres were retrieved from the ocean where they had been exposed to a preload of 50 percent of their ultimate strength for 5.3 years. These preloaded spheres were tested in the laboratory under short-term loading and, in general, behaved similarly to that of non-preloaded spheres. Whether preloaded or non-preloaded, the saturated (uncoated) concrete spheres had a tendency to fail at lower pressures than those of dry (coated) concrete spheres.
4. Three of the original 18 spheres have imploded in the ocean under long-term loading. The remaining spheres have withstood load levels of 0.3 to 0.8 of their predicted short-term strength.
5. The permeability of concrete in uncoated spheres has shown a decrease in rate with time and, in several cases, the permeation of sea water through the concrete wall has stopped. Coated (waterproofed) spheres remained dry on the interior (Figure 4.5).
6. X-ray diffraction analysis of the fog-cured and ocean-cured concrete has shown the 5.3-year ocean-cured concrete, whether coated or uncoated, to be essentially unchanged from the fog-cured concrete.

The results from this study show undersea concrete structures to behave exceptionally well at deep ocean depths. The strength, permeability, and durability of the spheres are within or exceed engineering acceptability limits. Confidence in using concrete for undersea structures is substantiated and enhanced by the results of this ocean test [4.33].

4.7.3 Cylindrical Structures

Failure of concrete cylindrical structures under hydrostatic loading can be described by one of three equations: (1) an average wall

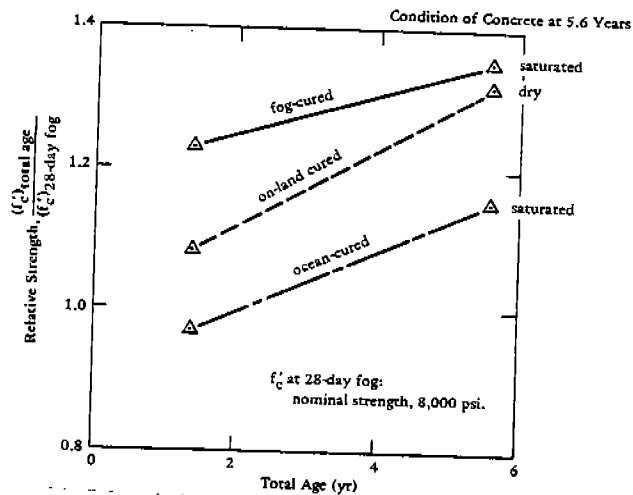

FIGURE 4.4 COMPRESSIVE STRENGTH GAIN OF CONCRETE IN DIFFERENT ENVIRONMENTS (FROM [4.34])

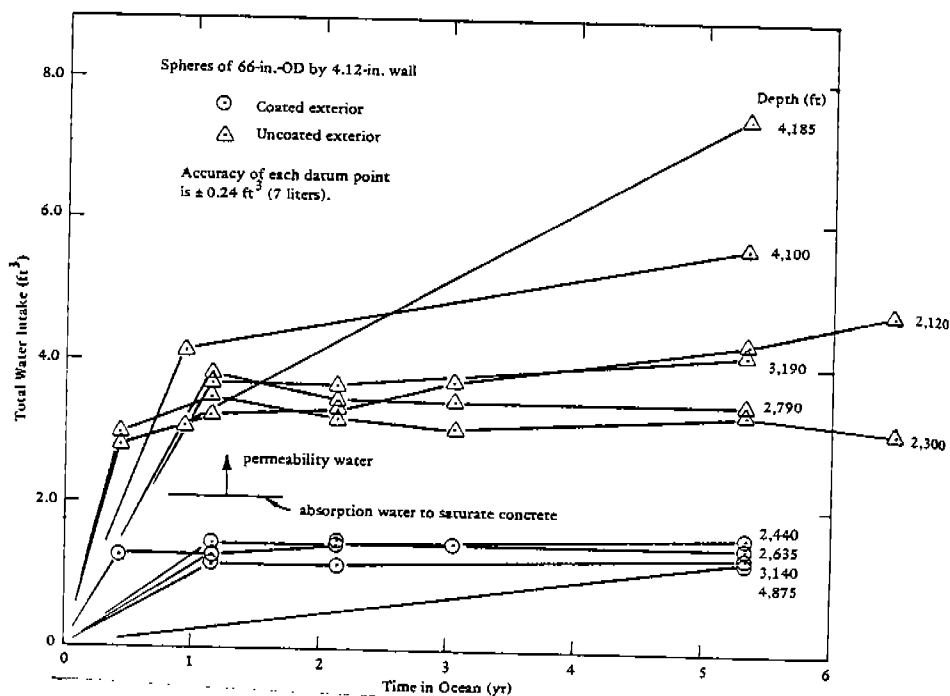

FIGURE 4.5 TOTAL WATER INTAKE FOR SPHERES IN THE OCEAN FOR LONG TIME PERIODS (FROM [4.34])

stress equation applies to thick-walled cylinders; (2) Donnell's equation [4.35] to moderately long, thin-walled cylinders; and (3) Bresse's equation [4.36] to long thin-walled cylinders. A series of tests was performed at the Civil Engineering Laboratory to determine the empirical parameters used in each equation to obtain agreement between the experimental results and theoretical expression. This section discusses the analytical and experimental work which led to a design guide for predicting the implosion of concrete cylinders with a wide range of geometries. (Figure 4.6).

The design approach for unreinforced, thick-walled cylinders is based on an average stress distribution across the wall of the cylinder at implosion. The expression used to predict implosion pressure, P_{im} , for thick-walled cylinders is from [4.37]:

$$P_{im} = 2 k_c f'_c \left(\frac{t}{D_o} \right) \quad (4.4)$$

where

$$k_c = 1.25 - 0.12(L/D_o) \text{ for } L/D_o < 2$$

$$k_c = 1.0 \quad \text{for } L/D_o \geq 2 \text{ (L = cylinder length)}$$

was determined empirically. Results for thick-walled cylinders are incorporated into the design guide (Figure 4.6).

Thin-walled cylinders are divided into two categories: (1) moderately long cylinders which are influenced by end closures which restrain the cylinder from instability failure, and (2) long cylinders which are not influenced by end closures and behave as infinitely long cylinders. Donnell's equation is the basis of the determination of the implosion pressure, P_{im} , for moderately long cylinders, and Bresse's equation is used for long cylinders. Under the assumption that Poisson's ratio (ν) equals 0.2 and that the mean radius is approximately equal to the outside radius of the cylinder, the equations become

Moderately Long Cylinders

$$\sigma_{im} = \frac{1.25 E_i \eta \left(\frac{t}{D_o} \right)^{1.5}}{L/D_o} \quad \text{(Donnell)} \quad (4.5)$$

Long Cylinders

$$\sigma_{im} = 1.04 E_i \eta \left(\frac{t}{D_o} \right)^2 \quad \text{(Bresse)} \quad (4.6)$$

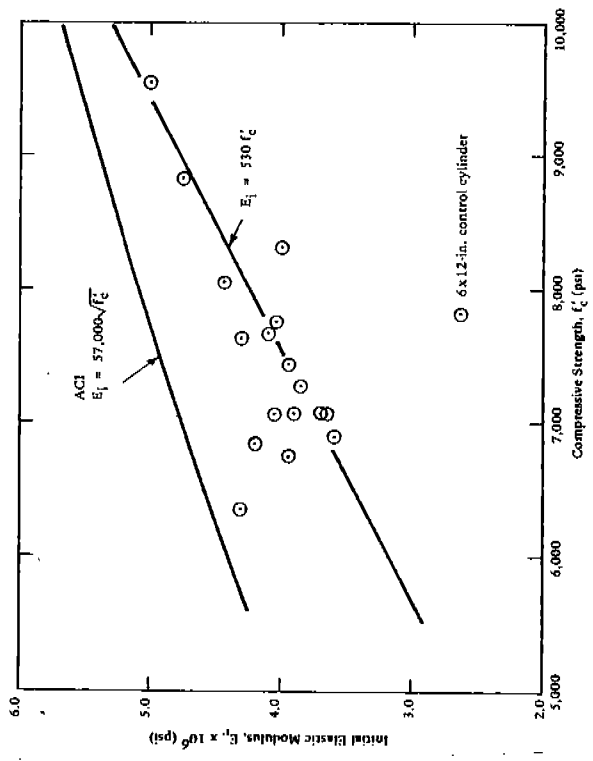

FIGURE 4.7 RELATIONSHIP BETWEEN E_1 AND f'_c
(FROM [4.37])

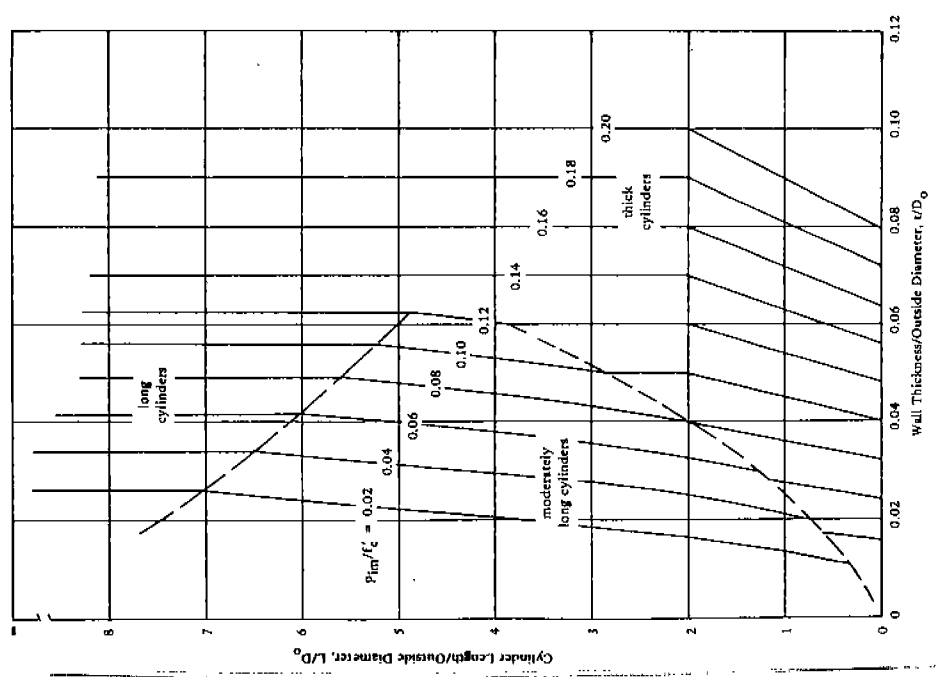

FIGURE 4.6 DESIGN GUIDE FOR PREDICTING
IMPLOSION OF CONCRETE CYLINDER
(FROM [4.37])

where

E_i = initial elastic modulus

η = plasticity reduction factor.

The initial elastic modulus, E_i , was not measured for each specimen so an empirical relationship was developed to calculate its value. Figure 4.7 shows the experimental initial elastic moduli data as a function of compressive strength. The American Concrete Institute (ACI) expression for elastic modulus is shown for comparison, along with the following empirical expression developed in reference 4.37.

$$E_i = 530 f'_c \quad (4.7)$$

A plasticity reduction factor, η , is used in both equations to account for inelastic behavior of concrete and specimen out-of-roundness. Values of η were determined by calculating the elastic stress at buckling and dividing this stress into the experimental stress at implosion. From representative data, a design η curve was selected, which is applicable to both moderately long and long cylinders. The η expression is, from [4.37],

$$\eta = 1.65 - 1.25 \left(\frac{\sigma_{im}}{f'_c} \right) \quad 0.52 < \frac{\sigma_{im}}{f'_c} < 1 \quad (4.8)$$

By substituting expressions (4.7) and (4.8) into equations (4.5) and (4.6), the following results are obtained:

Moderately Long Cylinders

$$\frac{\sigma_{im}}{f'_c} = \frac{1090 \left(\frac{t}{D_o} \right)^{1.5}}{\frac{L}{D_o} + 830 \left(\frac{t}{D_o} \right)^{1.5}} \quad (4.9)$$

Long Cylinders

$$\frac{\sigma_{im}}{f'_c} = \frac{910 \left(\frac{t}{D_o} \right)^2}{1 + 690 \left(\frac{t}{D_o} \right)^2} \quad (4.10)$$

The stress level at implosion, σ_{im}/f'_c , is calculated by knowing the geometry of the cylinder structure. The following conditions determine the next step:

- (a) If $\sigma_{im}/f'_c > 1.0$, thick-wall analysis, equation (4.4), is used to predict implosion,

(b) If $0.52 < \sigma_{im}/f'_c < 1.0$, then η is calculated by equation (4.8),

(c) If $\sigma_{im}/f'_c < 0.52$, then $\eta = 1.0$.

If conditions (b) or (c) control, the implosion pressure can be computed by substituting equations (4.9) or (4.10) into the expression

$$\sigma_{im} = P_{im} \frac{R_o}{t} \quad (4.11)$$

where

σ_{im} = wall stress at implosion

P_{im} = implosion pressure

R_o = outside radius

t = average wall thickness.

Equation (4.11) assumes that, near implosion, the stress distribution across the wall is nearly uniform. The final results for conditions (b) and (c) are

Moderately Long Cylinders

$$P_{im} = \frac{1320 \eta f'_c \left(\frac{t}{D_o}\right)^{2.5}}{L/D_o} \quad (4.12)$$

Long Cylinders

$$P_{im} = 1100 \eta f'_c \left(\frac{t}{D_o}\right)^3 \quad (4.13)$$

All analytical results for the three cylinder types are presented in Figure 4.6. To determine the P_{im}/f'_c ratio, enter the chart with the structure's L/D_o and t/D_o ratio. Reference 4.37 indicates that the moderately long cylinders are assumed to have simple-support end conditions. If fixed-support end conditions are present, an increase of about 6 percent in implosion strength can be expected.

The reader should refer to references 4.33, 4.34, and 4.37 for a complete description of the analytical work and test program conducted at the Civil Engineering Laboratory on subsea spherical and cylindrical structures.

4.8 Fatigue

4.8.1 Introduction

Research in the area of fatigue of concrete structures in the marine environment has been conducted by a large number of organizations. A typical concrete sea structure or ship may be subjected to about 1×10^8 waves in its lifetime (20 years), of which about 1×10^7 may create significant changes in stress [4.38]. The fatigue characteristics of the reinforcements and concrete in air are well known, but the influence of the marine environment is not accurately defined. The major factors that influence concrete fatigue strength are [4.39]

- o Stress range, history, gradient, and rate
- o Environmental conditions
- o Material properties

Evaluating the fatigue capacity of prestressed concrete members in marine floating structures is complex because the random wave load does not correspond to the uniform load cycling of experimental tests. To perform an adequate evaluation requires the integration of at least three steps [4.39]:

- o Selection of locations where fatigue stresses may be critical.
- o Projection of a load histogram for the structural member.
- o Determination of critical fatigue stresses and comparison of these to allowable stresses.

4.8.2 Research in the United States

The majority of fatigue research in the U.S. has been associated with reinforced concrete in an air environment. The ACI Abeles Symposium [4.40] contains a large number of papers describing research on the fatigue strength of reinforcements. The Portland Cement Association (PCA) has published a design bulletin concerning the design of reinforced concrete for fatigue (reference 4.41). The major findings of this report were:

- (1) Presently the effects of cyclic stressing on reinforcing bars are sufficiently well known that safe limits may be placed on their usage in ordinary structures and under ordinary circumstances.
- (2) Little or no information is yet available to guide the designer in the use of products such as galvanized reinforcing bars and in applications where environmental extremes or time-dependent effects prevail. Additionally, the effects of bar cutoffs and bent-up bars on fatigue strength have not been fully clarified.

- (3) The recent change to the Load Factor method in bridge design specifications has brought forth a fresh awareness of serviceability criteria as major design factors. Most design procedures are sufficiently developed that serviceability criteria are adequate. The influence of serviceability requirements on the final design in some cases has pointed out the need for an improved definition of what service loadings actually consist of and how they should be applied, for instance, in fatigue design. Service load magnitudes and conditions are often based on those previously used in Working Stress Design and do not always reflect the reality of extreme service conditions. There is, therefore, a need for code writing bodies to address themselves to such problems.

The Prestressed Concrete Institute (PCI) and Society of Naval Architects and Marine Engineers (SNAME) both have documents on prestressed concrete for ocean structures [4.38] and [4.39]. Both reports give general discussion and references for fatigue considerations. SNAME has also published a bulletin specifically on the fatigue of concrete ship structures [4.42]. General conclusions of this report are:

- (1) Prestressed concrete subjected to axial loadings with stresses within current design limitations will not suffer failure from high-cycle fatigue under a normal service life. The probable life history of a typical vessel generates stress ranges well below the endurance limits of prestressed concrete and its components (Figures 4.8 and 4.9). Concern should therefore be directed to low-cycle, high-intensity fatigue, with cracking occurring at any time in the life history of the vessel. This low-cycle fatigue can either be the design storm or a nominal 15-day storm history, with the stress range varying from the maximum at one cycle to zero at 2×10^5 cycles.
- (2) Any fatigue investigation needs to consider shear (direct shear plus torsional shear) under cyclic loadings. For critical sections, all shear should be carried either by the concrete in permanent compression under prestress or by stirrups. For the typical concrete vessel, the provision of substantial vertical prestress in the sides and longitudinal bulkheads will usually be found to be the optimum solution.
- (3) Bond failure under cyclic loading is a primary concern. It can be prevented by doubling the code bond length in all critical areas and by confinement of splices.
- (4) Submergence can adversely affect the fatigue life for members which have reopening cracks under cyclic loads. This can and

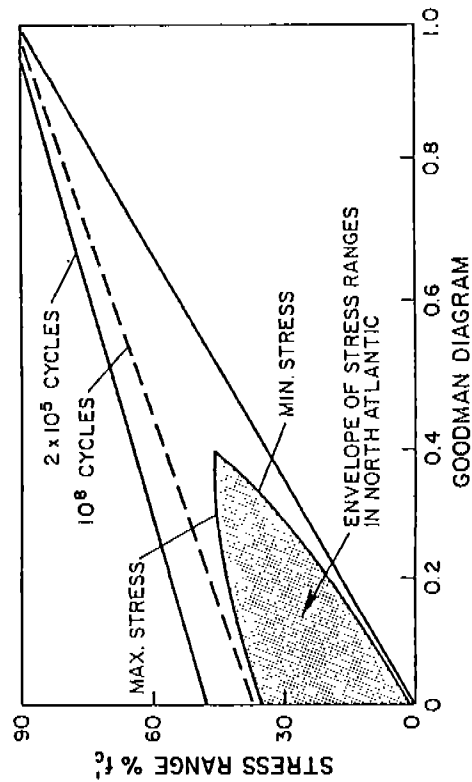
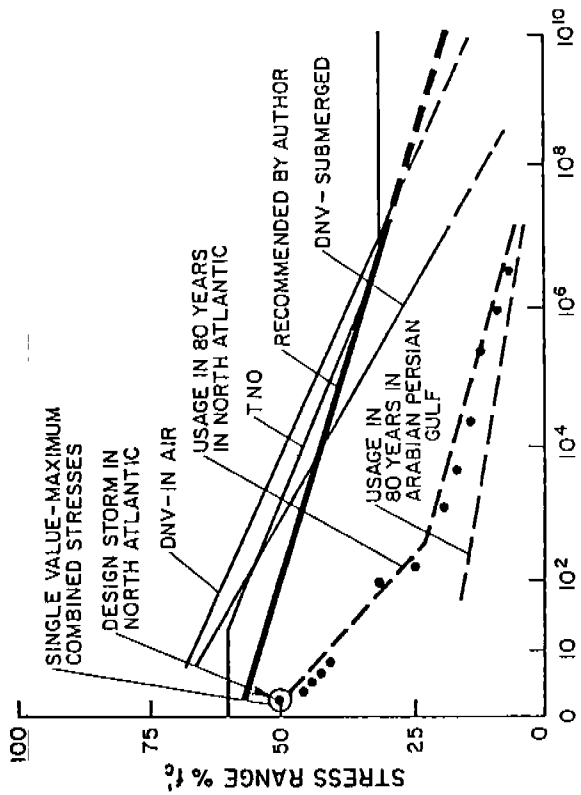

FIGURE 4.8 FATIGUE ENDURANCE OF CONCRETE IN PRESTRESSED CONCRETE HULL (FROM [4.42])

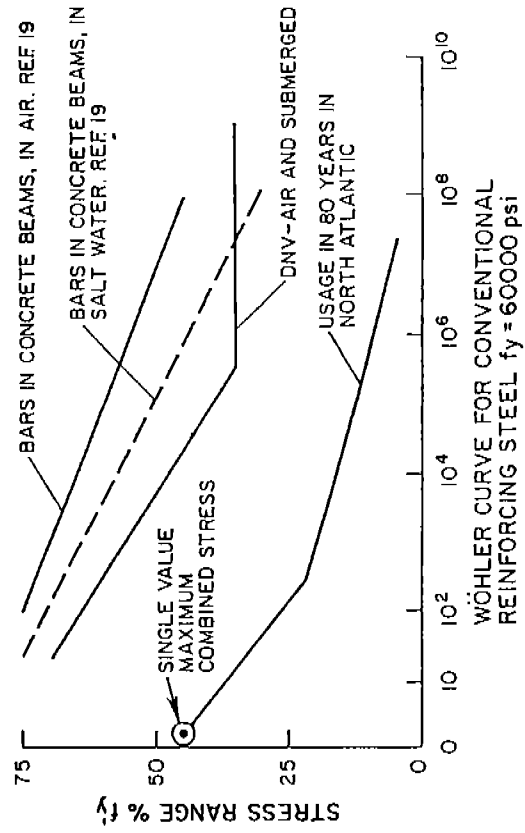
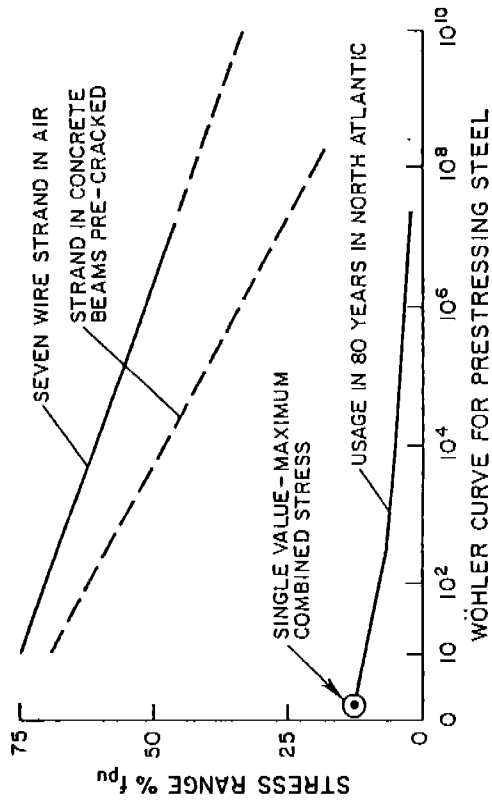

FIGURE 4.9 FATIGUE ENDURANCE OF REINFORCEMENT IN PRESTRESSED CONCRETE HULL (FROM [4.42])

should be prevented by providing crossing or confining steel, prestressed or passive. For a typical vessel's hull, the transverse prestress in the deck and bottom will effectively prevent the splitting along the longitudinal tendons. There should be sufficient steel area in all critical areas to ensure that if the concrete does crack for any reason, the force can be transferred to the steel without exceeding the yield strength of the tendons. This generally requires a total steel percentage of at least 0.8 percent. These provisions for minimum steel area and confinement will effectively prevent low-cycle high-intensity fatigue.

- (5) Structural lightweight aggregate concrete performs similarly, but slightly less effectively than normal concrete in resisting fatigue. In particular, cracking may start at lower tensile stresses; hence, excursions into the tensile range should be limited by reducing maximum tensile stresses. Diagonal tension cracking should be prevented by providing adequate stirrups.
- (6) Prestressing steels have satisfactory fatigue properties at cryogenic temperatures. Conventional steel in the form of stirrups, etc., may have sharply reduced fatigue strength at very low temperatures; hence, the use of cold-drawn wire and unstressed prestressing steel should be considered.
- (7) With proper design and construction practice, prestressed concrete vessels can be built which have an acceptably low probability of fatigue damage to any component and an extremely low probability of significant global fatigue failure a wide range of environmental and service conditions.

Reference 4.2 indicates that, based on a survey of existing test and field data, fatigue for a prestressed concrete vessel is only a critical criterion at the low-cycle, high-intensity end of the spectrum.

Because of the lack of data on the effects of submergence, frequency, and cracking, reference 4.42 recommended that a research test program should be conducted on concrete both in air and submerged in salt water to a head of 10 to 20 m (32 to 64 ft.). Such a program would consider prestressed concrete slabs, posttensioned longitudinally and transversely to about 8 and 5.5 MPa (1,200 and 800 psi), respectively. Mild steel reinforcement would be installed on both faces in both directions. Testing would be at a frequency of about 0.1 Hertz, representative of storm waves. The concrete would be axially stressed to cracking in the tensile range (so as to produce cracks of width 0.1 to 0.5 mm (0.004 to 0.02 in.) and to 40 percent to 60 percent f'_c in the compressive range.

Reference 4.42 also recommends that similar tests be conducted in cyclic shear (so as to simulate the action on the side of the vessel). The loading would produce cracking in diagonal tension, thus simulating the extreme loads anticipated during a vessel's lifetime.

4.8.3 Research in the European Countries

Various European codes and recommended design procedures have incorporated fatigue considerations. For example, the Det norske Veritas rules [2.1] introduces its section on fatigue with the following paragraph.

"The fatigue strength of reinforced and prestressed offshore concrete structures is presently not well documented. Earlier experience on structures cannot easily be extrapolated since structural parts of offshore structures are exposed to more dynamic and complex loading than other structures, including the effect of hydrostatic pressure."

These rules cover the areas of (1) cumulative fatigue damage, (2) concrete compressive, flexural and shear strengths, (3) bond between reinforcement and concrete, and (4) reinforcement and tendon strength. Waagaard [4.43] at DnV, project leader for the COSMAR program on fatigue, published an article on the fatigue strength of offshore concrete structures, in which the following rules and guidelines were reviewed:

- o Det Norske Veritas "Rules for the Design, Construction and Inspection of Offshore Structures," Appendix D - Concrete Structures" [2.1]
- o FIP "Recommendations for the Design and Construction of Offshore Sea Structures" [4.13]
- o ACI "Guide for the Design and Construction of Fixed Offshore Concrete Structures" [2.8]
- o Norwegian Petroleum Directorate "Regulation for the Structural Design of Fixed Structures on the Norwegian Continental Shelf" [4.44].

The above were reviewed with respect to the following parameters:

- o S-N curves for concrete in compression
- o Cracking limitations
- o S-N curves for reinforcement
- o Transverse shear capacity
- o Cumulative fatigue life

Major conclusions from [4.43] were:

- (1) The random nature of environmental loading on an offshore installation has made it necessary for the designer to go into greater detail in fatigue strength evaluations. Cumulative analyses with the help of Miner's hypothesis has shown that the variation in the Miner sum is both a variable of concrete strength variation and of loading sequence. The Miner sum should, for random loading when applied to concrete structures, be less than one.
- (2) In converting experimental data into design, one should ensure that the same method is used in evaluating the test data as is used in design. Fatigue curves will, for example, be method dependent, and direct comparisons of levels of fatigue curves may not adequately represent an evaluation of the safety for different requirements.
- (3) It is important to note that the marine environment has a deteriorating influence on the fatigue properties of both concrete and reinforcements. From an evaluation of actual stress and cracking conditions, the behavior of concrete and tendons in fatigue will need the most careful consideration. In concrete, both the effect of pumping water in and out of cracks and the effect of pore pressure should be included in the analysis.

A number of experimental efforts on the fatigue behavior of concrete are being conducted under the auspices of the European research programs described in Sections 4.3 ~ 4.5. Recent results are reported in references 4.43 and 4.45 - 4.48. The European work currently in progress does address some of the questions concerning fatigue raised by Gerwick [4.42] and mentioned in Section 4.8.2; namely,

- o the effect of sea water corrosion
- o the effect of loading frequency.

The interaction between corrosion and the loading frequency is a complex phenomenon. For example, it has been well established that in steels, corrosion fatigue is frequency dependent. Fatigue tests in air are generally frequency independent, but tests conducted in sea water at about 0.1 to 0.2 Hertz (typical ocean wave frequencies) show a decrease in fatigue life by a factor of about of two to five. If the frequency of the sea water tests is increased to above about one Hertz, the corrosion fatigue effect on steel essentially disappears, and the fatigue life is restored to the in-air value. Therefore, it is important to conduct such tests under the expected loading frequencies. The process is further complicated by the buildup, with time, of deposits in the cracks of the

concrete. These deposits consist primarily of calcium carbonate (CaCO_3) and/or magnesium hydroxide ($\text{Mg}(\text{OH})_2$). In fatigue tests on reinforced concrete beams, European investigators [4.45, 4.46] have found a marked decrease in deflections due to blockage of cracks by these deposits. Figures 4.10 and 4.11 show typical reinforced concrete beam specimens and loading arrangement for unidirectional and reverse bending. The center portion of the concrete beam is immersed in a tank containing the sea water. Controls are generally established on water salinity, temperature, pH level, and flow rate.

The tests generally reveal a deleterious effect of the sea water corrosion on the fatigue life of the reinforced beams. Figure 4.12 shows some interesting results from reference 4.45. Under unidirectional bending, the fatigue life (O) in sea water (conducted at 0.17 Hz) appears to be enhanced, even over the expected life in air (X). The investigators attribute this to blockage of the cracks on the tension side, which reduces the stress range in the reinforcing bars. However, under reverse bending, blocking of the cracks on both sides of the beam occurs with an increase in mean stress but no decrease in stress range. Hence, the fatigue life is reduced compared with in-air tests. This last observation is confirmed by other investigators [4.47, 4.48]. The increased fatigue life in water under unidirectional loading reported in reference 4.45 has not been confirmed, and work is still ongoing to resolve these differences.

Only a limited number of fatigue tests have been conducted under a simulated water depth. Reference 4.45 indicates that in two tests completed at 30-m depth, at a stress range of 360 MPa and 0.1 Hertz, there was no evidence of any greater spalling of the concrete at cracks than had occurred in the tests at atmospheric pressure in a sea water environment.

4.9 Strength

4.9.1 Introduction

Reinforced concrete used in floating marine structures will be subjected to a variety of loading conditions. The primary deflection and stress response of the entire hull behaving as a beam, the secondary response of a local stiffened panel, and tertiary response of the shell between stiffeners, must be analyzed during the design of the structure. A primary consideration in the design is the strength, usually defined as a function of the ultimate compressive strength of the concrete elements. When considering a floating structure, the strength/weight ratio of the concrete is the controlling factor rather than strength alone.

Concrete for marine applications can be divided into several major categories according to its weight and strength (Table 4.13).

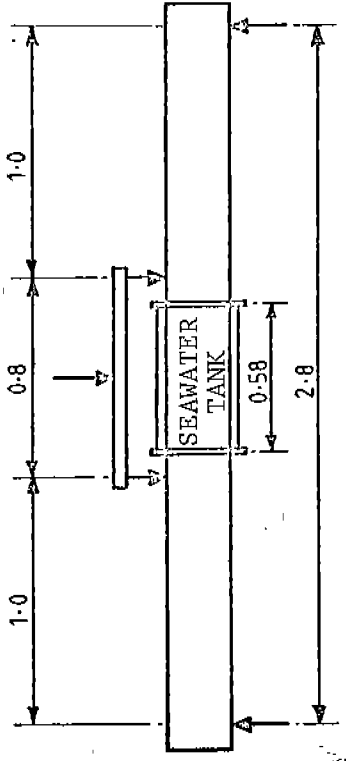

a. Unidirectional Bending

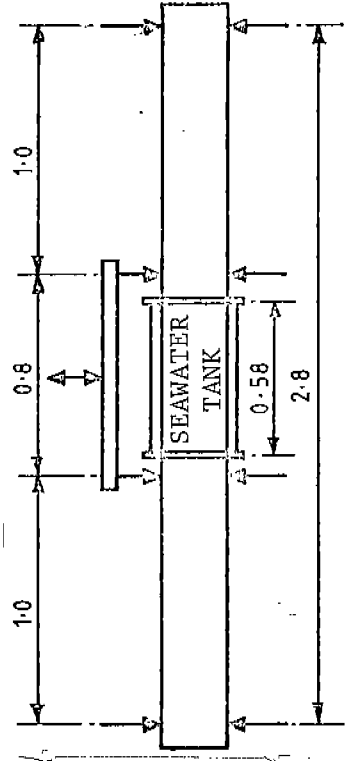

b. Reverse Bending

DIMENSIONS IN METERS

FIGURE 4.11 FATIGUE TESTS LOADING ARRANGEMENTS (FROM [4.45])

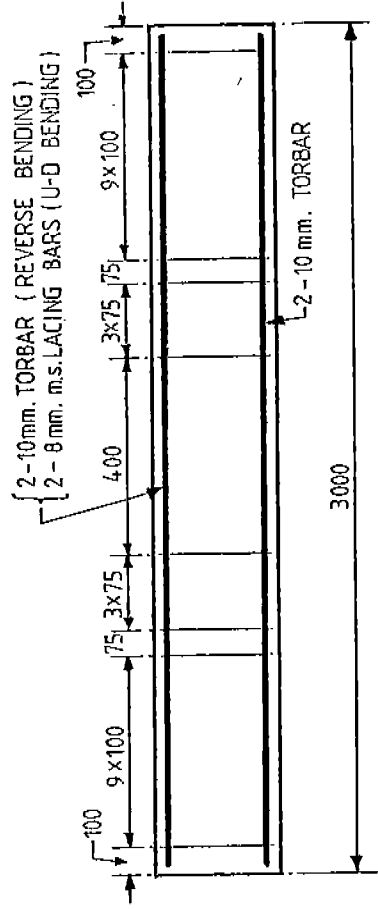
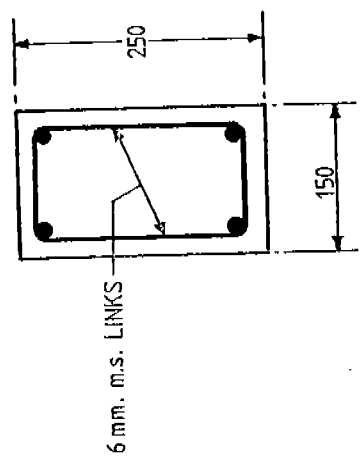
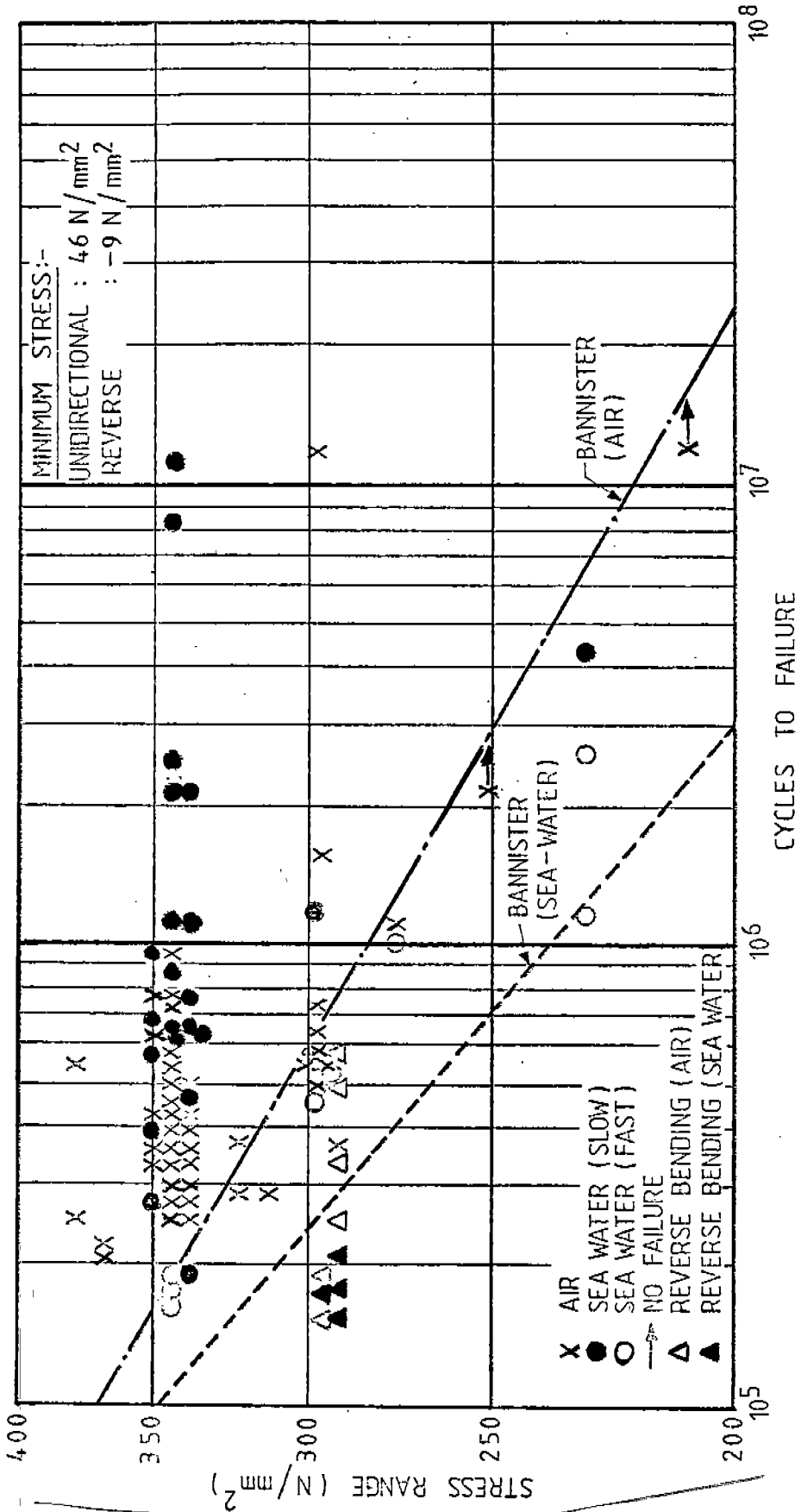

FIGURE 4.10 REINFORCING DETAILS OF TEST BEAM (FROM [4.45])



BANNISTER, REF. [4.48]

FIGURE 4.12 FATIGUE TEST RESULTS ON REINFORCED CONCRETE BEAM IN SEA WATER (FROM [4.45])

TABLE 4.13 TYPE OF CONCRETE

| Type | Unit Weight | | Compressive Strength | |
|------------------------|----------------------|-----------------------|----------------------|----------------|
| | (Kg/m ³) | (lb/ft ³) | (MPa) | (psi) |
| Lightweight | 240-1840 | (15-115) | <17 | (<2500) |
| Structural Lightweight | 1200-1840 | (75-115) | 17 to 40 | (2500 to 6000) |
| Normal Weight | 1840-3600 | (115-225) | 17 to 55 | (2500 to 8000) |
| Heavyweight | >3600 | (>225) | 17 to 55 | (2500 to 8000) |

The first type is primarily used for insulation and fill and therefore has minimal application to floating marine structures. One possible exception is for use as an insulation in LNG tankers. The majority of research into the use of concrete in the marine environment has been concentrated in structural lightweight concrete. A summary of some of the research being carried out in this area is given in Section 4.9.2. The largest body of research information currently available is for normal weight concrete. More recent research in the United States is concerned with high-strength concrete, with ultimate strengths in the range of 100 MPa (14,500 psi) [4.49]. Similar research in high-strength concrete has been carried out in Europe [4.50]. The objectives of these types of studies are to produce high-strength concrete for use in areas of high loading and to reduce the weight of the structure. Heavyweight concrete is not applicable to floating concrete structures.

In conjunction with strength, temperature effects and impact behavior must also be considered. Low temperature (e.g., LNG application) and high temperature (e.g., hot oils) ranges may be present in the structure. Impact resistance is critical when considering collision with other marine structures, falling objects, and ice. Each of these subjects will be discussed in some detail in the following sections. The reader should also refer back to Sections 4.2 to 4.5 for a summary of the research programs that have been carried out in the United States, United Kingdom, Netherlands, and Norway.

4.9.2 Structural Lightweight Concrete

The use of structural lightweight concrete has had a significant influence on the construction of floating marine structures. The majority of ships constructed during WWI and WWII were built using structural lightweight concrete [3.22]. During WWI the Emergency Fleet Corporation used expanded shales and clay aggregates resulting in concretes with 28-day compressive strengths greater than 27.6 Mpa (4000 psi) and unit weights of approximately 1760 Kg/m³ (110 pcf) [4.5]. This was a weight reduction of approximately 25 percent when compared to normal weight concrete. Significant improvements were made on the ships constructed during WWII. Concrete weights and strengths varied from 1728 to 2048 Kg/m³ (108 to 128 pcf) and 35.1 to 47.7 Mpa (5085 to 6920 psi), depending on the specific yard at which the concrete was mixed [4.51]. Some additional data on the specific aggregates used can be found in Section 3.2. Most applications since WWII have been concerned with gravity platforms where the weight of concrete is not critical. One area where structural lightweight concrete has been studied has been associated with the OTEC concept. Studies have been performed in the United States to look at a lightweight concrete

using a polymer-filled aggregate (PFA) [4.52]. In addition, several review studies have appeared in Europe [4.14, 4.16].

T. A. Holmes has compiled a summary of the performance of structural lightweight concrete in the marine environment [4.53]. This American Concrete Institute publication addresses both the historical aspects and several areas of research. Work in freeze-thaw testing such as discussed in Section 4.6 at the Treat Island, Maine, Concrete Exposure Station, is briefly summarized by Holmes:

The results of these major problems that include hundreds of laboratory tests may be simplistically summarized by noting that air-entrained lightweight concretes proportioned with a high quality binder provide satisfactory durability results when tested under usual laboratory freeze-thaw programs.

One interesting characteristic of structural lightweight concrete was that the elastic moduli of the mortar, aggregate, and concrete were similar. By contrast, normal weight concrete has a much larger aggregate modulus, and the strength is limited by the mortar strength. The resulting overall strengths of the two types are therefore often similar. Holmes points out that the compressive strength of structural lightweight concrete is limited by the "particle strength of the largest piece of lightweight aggregate." In most instances the long-term strength of lightweight concrete was "equal to or greater than normal weight concretes with equal binder content."

One example of a program designed to improve the strength of the lightweight aggregate was that performed at the Civil Engineering Laboratory in connection with the OTEC program [4.52]. In this program the voids in the aggregate were impregnated with polymeric material with a specific gravity near one. In this way the weight of the polymer-filled aggregate concrete when submersed in water would not be any larger than that of normal structural lightweight concrete, but its strength would be improved. The results of this study are summarized in Table 4.14. The compressive strength increased by 26 percent, with failure occurring in the bond between the aggregate and cement matrix. Both the split tensile strength and elastic modulus of PFA showed only slight increases over normal structural lightweight concrete. Although the lightweight concrete can offer a savings in the total weight of marine structures when compared to normal weight concrete, additional costs associated with production of lightweight aggregate should be considered.

Two summaries of the use of lightweight concrete for marine applications have been published by the European community [4.14, 4.16]. These reviews consider the density, strength under various loads, deformation behavior, creep and shrinkage characteristics, thermal properties, durability, design, and construction. As noted earlier, the strengths of structural lightweight concretes are controlled by both the strengths of the individual aggregate as well as the aggregate to mortar bond. Concretes of strengths greater than 70 MPa (10,000 psi) with densities less than 2,000 Kg/m³ (125 pcf) are obtainable [4.16]. Several areas of research recommended include [4.16]:

TABLE 4.14. COMPARISON OF LIGHTWEIGHT AND NORMAL WEIGHT CONCRETE.
FROM [4.52]

| Mix No. | Compressive Strength ^a (psi) | | | Split Tensile Strength ^b (psi) | | | Elastic Modulus (x 10 ⁶ psi) | | | Poisson's Ratio | | |
|---------|--|--------------|------------------------------|--|------------|-----------------|--|-------------|-----------------|-----------------|--------------|-----------------|
| | Regular | PFA | % ^d Difference | Regular | PFA | % Difference | Regular | PFA | % Difference | Regular | PFA | % Difference |
| 1 | 3,840 4.6 ^c | 4,450 3.6 | +15.8 | 420 5.0 | 430 2.6 | +2.3 | 1.78 4.4 | 1.78 2.0 | 0 | 0.26 16.8 | 0.21 0.0 | -19.2 |
| 2 | 4,700 5.7 | 5,940 1.3 | +26.4 | 470 2.3 | 500 3.7 | +6.4 | 1.96 3.8 | 2.03 0.0 | +3.6 | 0.25 6.0 | 0.27 2.1 | +8.0 |
| 3 | 5,180 2.7 | 6,400 6.1 | +23.6 | 480 5.9 | 500 5.0 | +4.2 | 2.08 0.0 | 2.14 8.3 | +2.9 | 0.25 11.4 | 0.28 12.4 | +12.0 |
| 4 | 5,200 11.1 | 6,580 3.8 | +26.5 | 500 11.2 | 520 5.5 | +4.0 | 2.19 1.3 | 2.41 1.4 | +10.0 | 0.24 3.6 | 0.22 10.3 | -8.3 |

^a Average of six specimens.

^b Average of five specimens.

^c Average of three specimens.

$$\text{\% difference} = \frac{\text{PFA} - \text{Regular}}{\text{Regular}} (100)$$

^e Coefficient of variation.

4.66

486-328

176

176

- (1) Behavior when subjected to multiaxial loads occurring in marine structures.
- (2) Studies of thick-walled lightweight ($<1500 \text{ Kg/m}^3$, 95 pcf) concretes when subjected to a low temperature LNG environment.
- (3) The long-term strength and density of lightweight concrete when subjected to long-term hydrostatic heads.
- (4) Studies of surface impregnation of polymers subjected to increased corrosion and abrasion.

Reference 4.14 contains the following summary of the advantages and disadvantages of structural lightweight concrete.

Advantages

- (1) Additional buoyancy can be achieved by the use of a lighter concrete in floating structures.
- (2) Reinforcement and prestressing steel economy can be made in structures where a lighter concrete is used, particularly where the ratio of dead load to superimposed load is high.
- (3) Lighter structures afford savings in foundations and piling work.
- (4) Lightweight aggregates are porous and stable. They are better than dense aggregates where insulation is required, as in cryogenic design and for fire resistance.
- (5) Lightweight concrete exhibits better crack behavior due to shrinkage, creep, and thermal expansion.
- (6) Lightweight concrete has better energy absorption characteristics from impact and cyclic loading.
- (7) Lightweight concrete in construction can show considerable savings on transport, formwork, concrete placement, and plant maintenance.
- (8) The ability to cut, drill, and fix attachments to structural lightweight concrete is enhanced.

Disadvantages

- (1) Lightweight aggregates are more expensive than naturally occurring dense aggregates.
- (2) High-strength lightweight concretes may require more cement content in the mix, depending upon the aggregate chosen.

- (3) Larger prestressing losses arise from the lower modulus of elasticity and larger shrinkage and creep.
- (4) Greater care is required in controlling water content, mixing of lightweight concretes, and supervision to maintain strength and workability requirements.
- (5) Porous aggregates require special measures to pump the concrete.

4.9.3 Temperature Effects

Concrete used in marine structures will be exposed to a wide variety of temperatures from both cargo and the exterior environment. A large number of research programs have been carried out concerning the influence of the external environment on concrete structures. These include the durability studies carried out at Treat Island described in Section 4.6. Durability of concrete is influenced by both external environmental conditions, to be discussed in a later section, and internal conditions, to be discussed here.

A number of studies related to this subject have already been noted in this report.

- (1) Table 4.5 Project No. 3
Experimental Investigation of the Effects of Temperature Gradients on the Walls of Oil Storage Structures
- (2) Table 4.6 Project No. 4
Temperature Gradients
- (3) Table 4.6 Project No. D6.8
Temperature Gradients
- (4) Table 4.9 Project No. BK-5
Influence of Temperature Changes on Concrete
- (5) Table 4.11 Project No. 3
Development of Concrete Structures for Storage, and Transportation of LNG and Oil Including Thermal Effects

Investigators [4.54] studied the use of prestressed concrete as both primary and secondary barriers for LNG and LPG ships and barges and reported, "Prestressed concrete is the only material normally used at ambient temperature conditions that can also be used structurally at cyrogenic temperatures." Results of this work indicate that concrete has advantages when compared to steel for LNG/LPG application because its thermal response is slower, thereby resulting in less thermal shock and local temperature effects. As noted earlier in this report, additional effort is required to study the influence of temperature variations on thick shell structures. The European studies should provide some additional knowledge in this area.

4.9.4 Impact Behavior

An important consideration in the design of any floating marine structure is its resistance to impact loads. The loads can be the result of collisions with other vessels, stationary structures, icebergs or accidental loads such as fallen drilling pipe. As has been noted in Sections 3.2, 3.3 and 3.4, concrete structures have been found to be resistant to impact. A number of studies concerned with the impact resistance of concrete in conventional nuclear power plant design are available. These studies explore the impact resistance of concrete when struck by missiles such as hurricane-thrown telephone poles. In most cases analytical analysis of the problem is performed using either finite element or finite difference methods [4.55]. Additional studies on ocean structures are being carried out in conjunction with the Concrete in the Ocean Program (Tables 4.5 and 4.6).

4.10 Durability of Reinforced Concrete

4.10.1 Introduction

A practical consideration in the use of reinforced concrete for floating marine structures is its durability. In fact one of the main advantages of concrete over steel is the minimum maintenance required for a well-designed concrete structure. This section will look at some of the recent research programs examining the long-term durability of concrete and related subjects such as permeability, corrosion, abrasion, and resistance to chemical attack and marine organisms. The durability of concrete is a function of both the external conditions and the material characteristics of the hardened concrete and reinforcing steel.

Environmental exposure of a marine structure can be classified as occurring in three zones: (1) Atmospheric, (2) Tidal, and (3) Submerged [4.56]. Each of these zones has specific processes of deterioration associated with them, Figure 4.13. They include cracking due to corrosion of steel reinforcements, cracking due to freeze/thaw cycles, physical abrasion, and chemical decomposition. The material characteristics of the concrete plays an important role in its durability. The most important aspect is the permeability of the concrete which can be controlled by the permeability of the cement paste and the choice of aggregate. The mix must be designed for a high cement content and low water/cement ratio with additives to increase workability. In addition to a good mix, it is necessary to ensure that good construction practices are followed so that the concrete is compact, homogeneous, and has a smooth surface. If the proper mix is used, good construction practice followed, and a design to prevent local cracking generated, reinforced concrete will produce a durable floating marine structure.

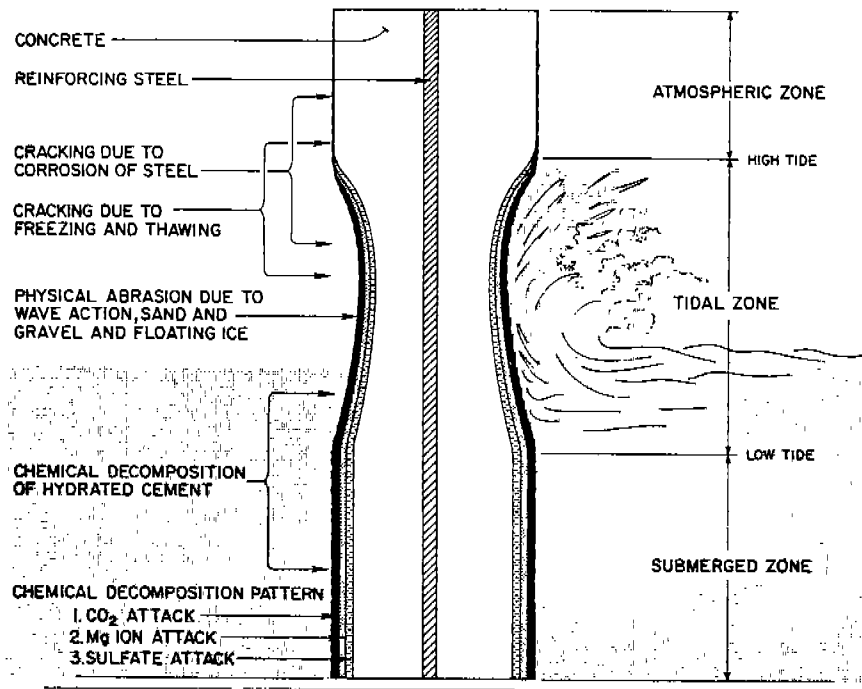

FIGURE 4.13. DETERIORATION OF A CONCRETE STRUCTURE IN SEA WATER (FROM [4.56])

The American Concrete Institute has published two books concerned with the durability of concrete [4.57, 4.58], which describe in detail a number of research programs on the subject. In the introductory paper in the second book, Mehta presents a review of the durability of concrete in sea water [4.56]. The following excerpt from this paper summarizes the results of case histories of concrete exposed to the marine environment.

The first lesson from the case histories of concrete damage in sea water is that portland-cement concretes invariably contain seeds of potential deterioration. These seeds are present in the form of the hydration products of portland cement, especially calcium hydroxide, which being basic in nature, are vulnerable to chemical decomposition as a result of chemical interaction with certain components of sea water, namely $MgCl_2$, $MgSO_4$, and CO_2 .

Whether these seeds turn into deleterious products depends mainly on the ability of a concrete to keep water from penetrating into the interior. Thus, the second lesson from the above case histories of concrete failures is that permeability of concrete is the most important property determining long-term durability. Again, from the case histories of deteriorated concretes, the following causes for lack of water-tightness can be identified:

(i) *Improper mix design:* Permeability of concrete is derived mainly from the permeability of cement paste. Low cement content and high-water cement ratio produce a readily permeable product on hydration. Poorly graded aggregate can also be a source of lack of water-tightness.

(ii) *Poor Concreting Practice:* Even a high quality concrete mixture can yield a permeable concrete if the concrete is not properly compacted. Poorly constructed joints can also permit percolation of water. Carelessness in placement, such as segregation of concrete mixture and formation of thick layers of laitance at joints, or dilution of concrete mixture with additional water, has frequently been identified as a source of concrete permeability.

(iii) *Cracks in Concrete:* Despite good quality of concrete and proper workmanship, concrete structures may yet be permeable to sea water if they develop cracks during the course of their service life. Among the common sources of cracking are excessive deflection due to load, carelessness in transporting precast members and driving precast piles, thermal stresses due to temperature gradient in thick concrete structures, freeze-thaw cycles on non-air-entrained concrete, corrosion of reinforcing steel and expansive chemical reactions such as these involving formation of ettringite and alkali-silica gel.

Another lesson from the case histories of concrete deterioration in sea water is that, depending on the tidal lines, the individual processes of deterioration tend to limit themselves to different parts of a structure. From this standpoint a structure can be divided into three zones (illustrated by Figure 4.13). The uppermost part, which is above the high-tide line, is not directly exposed to sea water. However, it is exposed to atmospheric air, winds carrying sea salts, and frost action. Consequently, cracking due to corrosion of reinforcement in concrete and/or freezing and thawing of concrete are the predominant deleterious phenomena in this zone. The structure in the tidal zone, which is between high-tide and low-tide mark, is not only vulnerable to cracking and spalling of concrete due to wetting and drying, frost action, and corrosion of reinforcement, but also to loss of material due to chemical decomposition of hydration products of cement, and impact of waves containing floating ice, sand, and gravel. The lower part of the structure, which is always submerged in sea water, is vulnerable to strength retrogression and loss of material as a result of the chemical reactions between sea water and hydration products of cement. Due to the absence of frost action and due to lack of oxygen, cracking of concrete due to freeze-thaw cycles and corrosion of the reinforcing steel is seldom a problem here.

115

A number of research programs have already been discussed in Section 4.6 concerning the environmental aspects of the durability of concrete. The other major area of concern is the chemical mechanisms involved in the deterioration of concrete exposed to the three environmental zones. Sea water contains approximately 3.5 percent soluble salt by weight including $MgCl_2$ and $MgSO_4$. These, in conjunction with concentrations of CO_2 in the sea water, can chemically attack the portland cement resulting in a loss of material and strength. The chemical processes, described in reference 4.56, attack the $Ca(OH)_2$ in the portland cement and produce salts which are soluble and can be leached out. As the deterioration continues, additional lime is leached out and the strength is further reduced. To increase the durability of concrete it is necessary to develop a mix that resists this chemical attack by such techniques as (1) producing cements with less $Ca(OH)_2$ (Metha [4.58]), (2) adding pozzolans to reduce the amount of free lime (Regourd [4.58]), and (3) the use of aluminous cement instead of portland cement containing C_3A (Georye [4.58]). Regourd [4.59] lists the following conclusions concerning the durability of concrete in the marine environment.

Physico-chemical and microstructural studies of concrete and mortar cement pastes exposed to a marine environment have shown that:

- 1. The chemical attack of sea water on cement only occurs in the case of permeable concretes (low cement content, high w/c ratio, insufficient impermeability). A high porosity of the material aids in the diffusion of the aggressive ions, Cl^- , SO_4^{2-} , CO_3^{2-} , Mg^{2+} which results in a series of chemical reactions, leading to the degradation (erosion, cracking) and finally the destruction of concrete.*
- 2. C_4AF , in contrast to C_3A , does not act deleteriously. Though it forms ettringite, this through-solution ettringite is more dispersed and needles of Fe-substituted trisulfoaluminate do not ever grow very big. With C_3A , the expansive ettringite is more localized, gathering around the aluminate grains because of the very large supersaturation of the solution in alumina. C_6A_2F , richer in alumina than C_4AF , is less desirable.*
- 3. Portland cements lower than 10 percent C_3A resist to the immersion in sea water. An amount of C_3A higher than 10 percent leads to a greater expansion in cements rich in C_3S .*
- 4. Cements containing more than 65 percent slag have the greatest resistance to the sea.*
- 5. The stability of cements containing 20 percent pozzolana depends upon the mineralogical composition and the reactivity of the pozzolana. This stability in sea water is not always directly related to the lime absorption of the pozzolana.*

6. *Compressive or flexural strengths do not serve as a good basis for concrete durability once deterioration starts. The measure of expansion seems better suited for the evaluation of the corrosion.*

Abrasion and marine organism attacks can also affect the durability of concrete. The abrasion resistance of concrete is a function of the compressive strength, aggregate properties, and finishing and curing methods [4.5, 4.60]. For most marine concrete structures, the compressive strength is adequate to prevent abrasion. Finishing should be such that the surface concrete is smooth, compact, and strong. The main problem with marine organisms is due to fouling, which increases hull weight and frictional resistance. There is little chance of damage due to attack of organisms. Reference 4.60 is a good general reference on the durability of concrete.

4.10.2 Permeability

Permeability is the most important characteristic determining the long-term durability of concrete exposed to sea water [4.56]. Permeability, defined as the rate at which a liquid will penetrate the concrete, controls the rate of chemical attack, the amount of freeze-thaw damage and the rate of reinforcement corrosion [4.5]. The permeability of concrete is a function of the size, distribution, and continuity of voids in the hardened material. Voids in concrete can be divided into several groups [4.61].

- (1) Air voids due to mix and placing or the addition of air entrainers to reduce susceptibility to freeze-thaw cycles.
- (2) Submicroscopic capillary voids that are created by space originally occupied by the mix water.
- (3) Submicroscopic gel voids that are created as cement hydrates.
- (4) Voids found in normal and lightweight aggregate particles.
- (5) Internal cracks due to loading.
- (6) Voids around aggregate due to bleed water in high water-to-cement ratio mixes.
- (7) Honeycomb voids due to dry mixes and poorly compacted concrete.

In most cases, air voids are discrete and therefore have little influence on the permeability. During the process of hydration the capillary void volume due to the water decreases as the result of the formation of calcium-silicate-hydrate gel, whose volume is 60 percent greater than the original size of the cement grain. The net result is a replacement of capillary voids by gel voids which are smaller in size. The largest voids in hardened concrete are those that occur in the

aggregate. The last three types of voids listed above can be eliminated, to a great extent, by proper design, mixing, and placing [4.61].

The important aspects in limiting the permeability of concrete are mixes that have water-cement ratios near 0.4 and have sufficient amounts of cements. These will limit the amount of capillary and gel voids, thereby reducing the permeability of concrete. The effect of the water-cement ratio can be easily seen from Figure 4.14. Another interesting fact is that the permeability of concrete immersed in sea water tends to decrease with time, adding to its durability.

4.10.3 Corrosion

Another factor that must be considered is the corrosion of the steel reinforcing in the concrete. Corrosion of steel in concrete is an electrochemical process which depends on electrical resistivity of the material, pH of the cement paste in contact with steel, and diffusion of chlorides and oxygen into the concrete [4.56]. For structures exposed to a humid environment, the electrical resistivity has only minor influence and RH and chloride diffusion tend to control the rate of corrosion. The corrosion process can be divided into initiation, propagation, and final phases. The process of hydration of the cement results in the formation of a passive iron oxide film on the surface of most of the steel. This film and the free lime ($\text{pH} \approx 12.5$) protects the steel from further corrosion until the permeability allows chloride and oxygen to infiltrate the concrete to the steel and propagation begins. During the initiation phase the anodic reaction

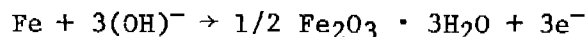

produces the protective film [4.56]. As the concentration of chlorides increases relative to the $(\text{OH})^-$ concentration, the anodic reaction becomes [4.56]:

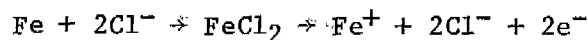

with a corresponding cathodic reaction if oxygen is present

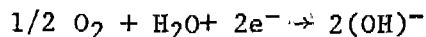

As this process continues, the area of the steel is slowly reduced. The final phase occurs when the formation of rust, which has a larger volume than the iron, causes the concrete to crack and spall, further increasing the corrosion rate.

Tuutti [4.63] has done extensive research into procedures designed to indicate the service lifetime of a reinforced concrete structure including the initiation and propagation phases. The four steps in this procedure are:

- (1) Compile the relevant materials, structural, and environmental data.

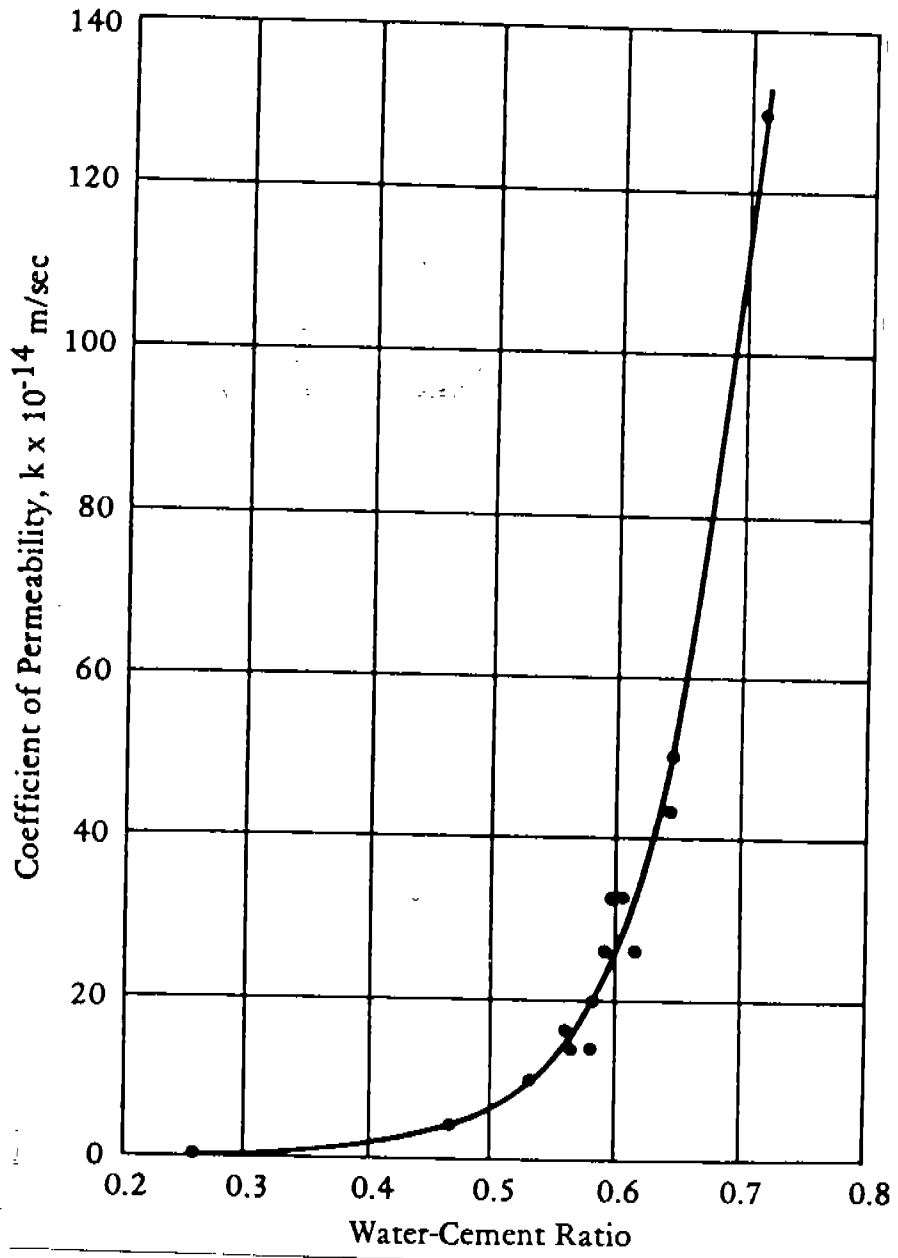

FIGURE 4.14. EFFECT OF WATER-CEMENT RATIO ON PERMEABILITY (FROM [4.62])

- (2) Calculate initiation time including carbonation and chloride initiation.
- (3) Calculate the relevant corrosion rate in the propagation stage.
- (4) Calculate the maximum corrosion depth.

These procedures, described in reference 4.63, are based on analysis, testing, and observation of structures.

Browne [4.64] describes the mechanisms involved and measurements made in looking at the corrosion of steel in concrete. The procedures he describes to predict the initiation and propagation times are similar to those described by Tuutti. Some of the conclusions of this paper are:

The approach described in the paper enables the time (t_0) to activate the steel to be estimated, of value to the design for life specification, as well as, the time to spall (t_1). Further collection of data on actual structures will add to the confidence in using this approach.

From this approach it is hoped that in the near future, a stronger basis can be formulated in national codes for the design for durability related to:

- (a) *the thickness of cover*
- (b) *the quality and type of concrete required in the cover zone*
- (c) *the curing of the concrete surface layers*
- (d) *the coating of potentially vulnerable areas*

The above items are interrelated. Thus for a specified design life in the aggressive atmospheric zone, in the future a low diffusion concrete, well cured, might be specified to enable the cover to be reduced. Thereby, the size of structural cracks may be reduced and obtain a saving in weight--provided, of course, it is not further reduced in the actual structure by poor workmanship. Further a surface coating to inhibit chloride ingress could be applied to provide an additional safety factor and substantially enhance the life, or alternatively, allow reductions in concrete quality or cover thickness for the same design life.

Underwater, conventional concrete structures in seawater are less vulnerable due to lack of oxygen. Offshore structures have to be considered more carefully as unique situations exist due, for example, to availability of oxygen from internally dry shafts, to more onerous dynamic wave loading conditions, to applied large scale cathodic protection systems and to the macro-scale of these structures.

It is hoped that in the future the civil engineer will become more aware that an understanding of the electrochemical nature of the problem is essential to appreciate the implications of specification for durability, and to aid inspection and evaluation of remedial techniques where damage has occurred.

4.11 Inspection and Repair

4.11.1 Introduction

As more and more concrete structures are built for use in the marine environment, the subject of inspection and repair becomes important. To ensure the continued safe operation of floating concrete structures, periodic inspection should be made. If signs of concrete cracking or spalling and reinforcement corrosion are observed, the extent of damage must be determined and its effect on the structural performance analyzed. Prior to repair of the structure, the cause of the damage must be determined and resolved, if possible, so that future problems can be eliminated. The materials and practices used to repair the structure must be of a sufficient quality to ensure that the structure will continue to satisfy its design requirements.

Inspection of concrete structures has been performed in all phases of the concrete construction industry. A recent review [4.5] looks at the specific requirements of reinforced concrete vessels. Two areas where the repair of damaged structures has been studied have been those exposed to abrasion as the result of moving fluids and earthquake damaged structures. The unique aspect of marine structures is that three zones of environmental conditions must be considered for inspection and repair: atmospheric, splash, and submerged. Each of these regions offers slightly different problems.

4.11.2 Inspection

Periodic inspection of marine structures is required by classification societies, and these inspections are designed to ensure the continued safe operation of the structures. Inspections are performed during construction as well as periodically during the service life.

(1) Inspection Before Concreting [4.5]

Prior to placement of concrete it is essential that reinforcement, prestressing tendons, formwork and embedments, and construction joints be inspected. This inspection is intended to ensure that all reinforcement and embedded items are properly placed and secured in position, and that formwork is correctly positioned to obtain final dimensions within tolerance limitations of the construction specifications. Once concrete is cast it is extremely difficult to correct deficiencies that may have occurred during fabrication and placing of reinforcement, embedments, and formwork.

(2) Inspection During Concreting [4.5]

General recommendations for measuring, mixing, transporting, and placing concrete are given by ACI Committee 304 [4.65]. These recommendations are applicable to use of concrete in marine structures. Checks of the batching, mixing and transportation procedures must be made to ensure that concrete of uniform quality and meeting construction specification is produced. Placing practices should be controlled to ensure the development of a uniform mix. In addition, control tests, including slump, unit weight, air content, temperature, and strength should be conducted as required.

(3) Inspection After Concreting [4.5]

After concreting is completed it is necessary to ensure that concrete is properly finished and cured and that formwork removal does not damage the young concrete or threaten safety of construction workers. Additional operations after concreting include evaluation of strength of hardened concrete, post-tensioning, and grouting.

(4) In-Service Inspection [4.5]

After a vessel has been constructed and put into service, it should be surveyed on a periodic basis for signs of deterioration of concrete, corrosion of reinforcement, and damage from overload, impact, abrasion, or fire. A well-designed and properly constructed concrete vessel should have a long service life.

It is this last phase that is unique to the marine concrete structure. There are three zones that will require inspection. Conditions in the atmospheric zone are similar to land-based structures. Inspection in the splash zone becomes more difficult with the alternating wet and dry conditions and waves. The submerged region requires inspection by divers or vessels with cameras attached. The most widely used means of inspection of both the concrete and steel is a visual inspection. These will give an indication of surface conditions as well as potential problems that exist under the surface.

The following procedures can be used to determine the characteristics of the concrete [4.66]:

- (1) Coring - Core samples can be taken and used to determine the strength, porosity, permeability, chloride content, chemical attack, mix proportion, and frost damage.
- (2) Impact Devices - A nondestructive method of obtaining the surface strength of concrete.
- (3) Ultrasonic Pulse Velocity - Used to determine the strength of concrete as well as the presence of voids and cracks.

- (4) X-ray Photography - Used to locate voids.
- (5) Gamma Radiography - Used to locate voids.

There are several methods available to determine the state of embedded steel in the concrete [4.66].

- (1) Visual - Observation of rust-staining, cracking, and spalling of the surface concrete.
- (2) Reinforcement Location - A common method used to determine the location of reinforcing bars is to measure the magnetic field and how it is distorted by the presence of steel.
- (3) Chloride Content - Determined by the coring procedure described above.
- (4) Electrochemical Potential - Measured using reference electrodes and a high impedance voltmeter.
- (5) Resistivity of the Concrete - Measured using a probe technique and an alternating current soil resistance meter.

The procedures described above are used to evaluate the state of both the concrete and reinforcing steel. Additional research in these areas is being conducted under the Concrete in the Oceans program in Europe. Additional research is required to develop procedures and equipment that can be used in each of the three zones of exposure that exist for marine structures.

4.11.3 Repair

Following inspection to determine the location and extent of damage, it is then necessary to determine what is required to insure the continued safe operation of the structure. The purpose of the repair can be any of the following [4.67, 4.68]:

- (1) Prevent corrosion of rebars and other imbedded steel
- (2) Restore full structural strength
- (3) Prevent leakage
- (4) Maintain or improve durability
- (5) Increase the strength of a structural element
- (6) Make additions to the structure

The type of materials used in the repair, preparation procedures, and repair techniques all depend on the purpose of the repair.

There is limited information on the strength and durability of materials and repair procedures as applicable to marine structures. Humphrys [4.67], Billington [4.68], and Browne [4.69] each describe some work that they have been involved with in conjunction with repair materials and procedures. Humphrys looked at two groups of materials, cementitious and epoxy based, that were considered suitable for repair and protection

of concrete under water. The cementitious grout was based on portland cement with a variety of admixtures to increase workability. The performance of the material was found to be satisfactory. The epoxy based resins were also found to be acceptable because of their low shrinkage, high strength, and good adhesive bond. The following points are noted concerning the choice of materials for repair [4.67]:

- (a) Cementitious grouts are very similar to concrete in all respects in their hardened state and would have to be used where the repair is required to replace concrete and reinstate the full strength of the structure.
- (b) Cementitious materials cannot be mixed under water at the work site; therefore, the period between mixing and placing is important.
- (c) Resin materials are stronger than concrete in tension, more elastic and resistant to impact. They are not suitable to replace concrete to reinstate full structural strength because of differences in mechanical properties (modulus of elasticity, thermal expansion, compressive strength).
- (d) Resins can be mixed as part of the placing operation.
- (e) Resins are less permeable and more inert than cementitious materials in sea water.
- (f) The bond of cementitious grouts is generally stronger than resins and less affected by microbial surface contamination.
- (g) Resins have lower viscosity than cementitious grouts and therefore are more suitable for injecting into narrow cracks.
- (h) The high exothermic reaction of epoxy resin materials restricts the volume/surface area ratio that is acceptable for a satisfactory repair; the higher the ambient temperature, the smaller the volume/surface ratio must be. The introduction of a filler, such as very coarse aggregate, into a void before injection of resin will reduce the heat generated and permit its satisfactory use in larger volumes of damage.

Billington [4.68] describes a research and development program to develop proven underwater techniques for repairing cracked and spalled areas on concrete offshore structures. The test included the materials used for primary surfaces, crack sealing prior to injection, crack injection, patching and bonding steel to concrete. The program was divided into five phases: (1) State-of-the-art review, (2) Evaluation of materials by small scale testing, (3) Evaluation of equipment for underwater surface preparation and application of repair materials, (4) Laboratory development

of proven repair techniques, and (5) Offshore trials. At the time the paper was written, Phases 1 and 2 had been completed, with work being continued on Phases 3 and 4. The results obtained were [4.68]

- (1) Prior to this project, no proven techniques were known to be available for the underwater repair of concrete offshore structures.
- (2) No proprietary materials tested during the course of this research have fully restored the strength of high-strength concrete underwater, although materials developed during the course of the work have achieved strengths consistently of 40 MPa when used for crack injection and 34 MPa when used for patching in the form of mortars.
- (3) Materials exist for the successful sealing of cracks underwater prior to injection.
- (4) An underwater repair system has been developed capable of use at any depth in which concrete structures are currently installed and which can be operated remotely without risk of danger to divers arising from medical aspects associated with the repair materials.

In reference 4.69, Browne describes the inspection program associated with the inspection of Total Oil Marine Ltd. platform MCP-01. The inspection procedures were designed to minimize the time required offshore and still ensure that a comprehensive and accurate survey was undertaken. Nondestructive testing was successfully used in the atmospheric zone, although no reliable procedure was used for the submerged zone. The authors concluded that methods for inspection of prestressing steel and the repair of major damage were insufficient. A continuing program to look at repair was to include [4.69]:

- (1) Methods of effectively joining reinforcement by lapping and coupling. Associated with these techniques, other problems such as straightening bars are being considered.
- (2) The structural requirements on the prestress to restore a structure to a safe operations condition.
- (3) Methods of replacing prestress in various structural layouts.
- (4) Development of methods for large placements of concrete underwater.
- (5) Assessing access techniques which would be required to complete repairs.
- (6) Development of computer-based techniques for assessing the damage caused by impact from loading history.

REFERENCES

- 4.1 "Research in Progress - 1978," Reported by ACI Committee 115, Title No. 75-43, Journal of the American Concrete Institute, Proceedings V. 75, No. 8, Aug. 1978, pp 404-413.
- 4.2 "Research in Progress - 1979," Reported by ACI Committee 115, Title No. 76-54, Journal of the American Concrete Institute, Proceedings V. 76, No. 12, Dec. 1979, pp 1305-1342.
- 4.3 "Index of Research Bulletins 1-227," Bulletin 228, published by Research and Development Laboratories, Portland Cement Association, Skokie, Illinois, July 1969.
- 4.4 "Index of Research and Development Bulletins RD000 through RD049," Bulletin RD050.0IT, published by Research and Development/Construction Technology Laboratories, Portland Cement Association, Skokie, Illinois, 1978.
- 4.5 Fiorato, R. E. and Johal, L. S., "Inspection Guide for Reinforced Concrete Vessels," Volume 1 - Inspection Guide, Volume 2 - Commentary, Construction Technology Laboratories, Portland Cement Association, Report CG-M-11-81, United States Coast Guard, Oct. 1981.
- 4.6 Scanlon, J. M., Jr., "Current Program and Future Corps of Engineers Plans for the Treat Island Exposure Station," International Conference on Performance of Concrete in Marine Environment, ACI SP-65, New Brunswick, Canada, Aug. 1980.
- 4.7 Peck, P. M., "List of Publications of the U.S. Army Engineer Waterways Experiment Station," Compiled and Indexed in the Special Projects Branch, Technical Information Center, U. S. Army Engineer Waterways Experiment Station, Vicksburg, Miss., June 1980.
- 4.8 "Directory of Marine Technology Research," Science Research Council Marine Technology Directorate, London, Sept. 1979.
- 4.9 Sharp, J. V., and Pullar-Strecker P., "The United Kingdom Concrete-in-the Oceans Program," International Conference on Performance of Concrete in Marine Environment, ACI SP-65, New Brunswick, Canada, Aug. 1980.
- 4.10 "Concrete in the Oceans," Brochure published by CIRIA, London.
- 4.11 "Research Programme 1980," Research and Development Division, Cement and Concrete Association, Wexham Springs, Slough, England.
- 4.12 Concrete Afloat, Proceedings of the Conference on Concrete Ships and Floating Structures, The Concrete Society, London, March 1977.
- 4.13 Prestressed Concrete Ships First Report - Considerations for Design, Fédération Internationale de la Précontrainte, FIP/4/1, Nov. 1975.

- 4.14 Structural Lightweight-Aggregate Concrete for Marine and Offshore Applications, Technical Report No. 16, The Concrete Society, London, 1978.
- 4.15 Recommendations for the Design and Construction of Concrete Sea Structures, FIP Report 6/1, Third Edition, Cement and Concrete Association, July 1977.
- 4.16 FIP State of the Art Report: Lightweight Aggregate Concrete for Marine Structures, FIP Report 8/2, Cement and Concrete Association, April 1978.
- 4.17 Heyning, G. A., "Netherlands Marine Technological Research," Second International Conference on Behaviour of Off-Shore Structures, Held at Imperial College, London, England, Aug. 1979.
- 4.18 "Offshore Concrete Structures - Research Activities - Technical Publications," Det norske Veritas, Høvik, Norway, March 1979.
- 4.19 Proceedings of the International Conference on the Behavior of Offshore Structures (BOSS '76), The Norwegian Institute of Technology, Trondheim, Norway, Aug. 1976.
- 4.20 Concrete Structures, Symposium held at the Norwegian Institute of Technology, Trondheim, Norway, Oct. 1978.
- 4.21 Sørensen, S. I., "Endochronic Theory in Nonlinear Finite Element Analysis of Reinforced Concrete, Report No. 78-1, Institutt for Statikk, Norwegian Institute of Technology, Trondheim, 1978.
- 4.22 Bergan, P. G., "Effects of Geometric Nonlinear Behaviour and Stability in Concrete Structures," IASS Symposium on Nonlinear Behaviour of Reinforced Concrete Spatial Structures, Darmstadt, West Germany, July 3-7, 1978.
- 4.23 Bergan, P. G. and Holand, I., "Nonlinear Finite Element Analysis of Concrete Structures," Computer Methods in Applied Mechanics and Engineering, Vol. 17/18, 1979, pp 443-467.
- 4.24 Arnesen, A., "Analysis of Reinforced Concrete Shells Considering Material and Geometric Nonlinearities," Report No. 79-1, Institutt for Statikk, Norwegian Institute of Technology, Trondheim, 1979.
- 4.25 Løseth, S., and Fiskvatn, A., "CYLSHELL - User's Manual - A Computer Program for Static Analysis of Interconnected Cylindrical Shells," Division of Structural Engineering, SINTEF, Report No. STF71 A95034, Trondheim, Norway, Jan. 1975.
- 4.26 Løseth, S., "CONSYM3 - User's Manual," Division of Structural Engineering, SINTEF, Report No. STF71 A79011, Trondheim, Norway, June 1979.

- 4.27 Gjørsv, O. E., Durability of Reinforced Concrete Wharves in Norwegian Harbours, Report of the Norwegian Committee on Concrete in Seawater, Ingeniørforlaget A/S, Oslo, 1968.
- 4.28 Gjørsv, O. E., "Concrete in the Oceans," Marine Science Communications, Vol. 1, No. 1, 1975, pp 51-74.
- 4.29 Gjørsv, O. E., and Vennesland, Ø., "Diffusion of Chloride Ions from Seawater in Concrete," Cement and Concrete Research, Vol. 9, 1979, pp 229-238.
- 4.30 Thornton, H. T., Jr., "Natural Weathering Exposure Station for Concrete and Concreting Materials - Treat Island, Maine," International Conference on Performance of Concrete in Marine Environment, ACI SP-65, New Brunswick, Canada, Aug. 1980.
- 4.31 O'Neil, E. F., "Study of Reinforced Concrete Beams Exposed to Marine Environment," International Conference on Performance of Concrete in Marine Environment, ACI SP-65, New Brunswick, Canada, Aug., 1980.
- 4.32 Haynes, H. H., "Long-Term Deep Ocean Test of Concrete Spherical Structures - Part I: Fabrication, Emplacement, and Initial Inspection," Civil Engineering Laboratory Technical Report R-805, Port Hueneme, California, March 1974.
- 4.33 Haynes, H. H., and Highberg, R. S., "Long-Term, Deep-Ocean Test of Concrete Spherical Structures - Results After 6 Years," Civil Engineering Laboratory Technical Report R 869, Port Hueneme, California, Jan. 1979.
- 4.34 Haynes, H. H., "Structural Consideration and Configuration III," Conference on Concrete Ships and Floating Structures, Berkeley, California, Sept. 1975.
- 4.35 Brush, D. O., and Almroth, R. B., Buckling of Bars, Plates, and Shells, McGraw-Hill Book Company, New York, 1975.
- 4.36 Timoshenko, S. P., and Gere, J. M., Theory of Elastic Stability, 2nd Edition, McGraw-Hill Book Company, New York, 1961.
- 4.37 Haynes, H. H., "Design for Implosion of Concrete Cylinder Structures under Hydrostatic Loading," Civil Engineering Laboratory Technical Report R 874, Port Hueneme, California, Aug. 1979.
- 4.38 Gerwick, B. C., Jr., "Prestressed Concrete Ocean Structures and Ships," Prestressed Concrete Institute, Chicago, Illinois, Sept. 1975.
- 4.39 Person, A., Chen, S., Hansen, G., Hartt, M., and Ozadogru, Y., "Use of Prestressed Concrete for Ship Hulls, Some Design Considerations and Material Practices," Global Marine Development Inc., Report No. RPT-04074-001B, Sept. 1979.

- 4.40 "Abeles Symposium, Fatigue of Concrete," ACI Special Publication SP-41, Detroit, 1974.
- 4.41 Corley, W. G., Hanson, J. M., and Helgason, T., "Design of Reinforced Concrete for Fatigue," PCA Research and Development Bulletin RD059.01D, ASCE Journal of the Structural Division, Vol. 104, No. ST6, June 1978.
- 4.42 Gerwick, B. C., Jr., and Venuti, W. J., "Fatigue Behavior of Prestressed Concrete on a Ship Hull," SNAME Technical and Research Bulletin 2-24, May 1979.
- 4.43 Waagaard, K., "Fatigue Strength Evaluation of Offshore Concrete Structures," ACI Convention, Dallas, Feb. 1981.
- 4.44 "Regulation for the Structural Design of Fixed Structures on the Norwegian Continental Shelf," Norwegian Petroleum Directorate, 1977.
- 4.45 Arthur, P. D., Earl, J. C., and Hodgkiess, T., "Corrosion Fatigue in Concrete for Marine Application," ACI Fall Convention, San Juan, Puerto Rico, 1980.
- 4.46 Paterson, W. S., "Fatigue of Reinforced Concrete in Sea Water," International Conference on Performance of Concrete in Marine Environment, ACI SP-65, New Brunswick, Canada, Aug. 1980.
- 4.47 Taylor, H. P. J., and Sharp, J. V., "Fatigue in Offshore Concrete Structures," The Structural Engineer, Vol. 56A, No. 3, Institution of Structural Engineers, London, March 1978.
- 4.48 Bannister, J. L., "Fatigue and Corrosion Fatigue of Tor Bar Reinforcement," The Structural Engineer, Vol. 56A, No. 3, Institution of Structural Engineers, London, March 1978.
- 4.49 Kaar, P. H., Hanson, N. W., and Capell, H. T., "Stress-Strain Characteristics of High Strength Concrete," Portland Cement Association Research and Development Bulletin RD051.01D, 1977.
- 4.50 Gjerde, T., "High Strength Prestressed Concrete for Floating Structures," Concrete Ships and Floating Structures Convention, Rotterdam, Nov. 1979.
- 4.51 Tuthill, L. H., "Concrete Operations in the Concrete Ship Program," Journal of the American Concrete Institute, Vol. 16, No. 3, Jan. 1945.
- 4.52 Haynes, H. H., and Eckroth, W. V., "Lightweight Concrete Using Polymer-Filled Aggregate for Ocean Applications - An Exploratory Investigation," Civil Engineering Laboratory Tech Note N-1565, Dec. 1979.
- 4.53 Holm, T. A., "Performance of Structural Lightweight Concrete in a Marine Environment," International Conference on Performance of

Concrete in Marine Environment, ACI SP-65, New Brunswick, Canada, Aug. 1980, pp 589-608.

- 4.54 Closner, J. J., and Marcha, T., "Prestressed Concrete for Primary Storage of LNG or LPG on Ships or Barges and as a Secondary Barrier," Proceedings of Conference on Concrete Ships and Floating Structures, Berkeley, Sept. 1975, pp 151-165.
- 4.55 Davies, I. L., and Mavrides, A., "Assessment of the Damage Arising from Collisions Between Ships and Offshore Structures," Second Interaction Symposium on the Integrity of Offshore Structures, Glasgow, Scotland, 1981.
- 4.56 Mehta, P. K., "Durability of Concrete in Marine Environment - A Review," Performance of Concrete in Marine Environment, ACI Publication SP-65, 1980, pp 1-20.
- 4.57 Durability of Concrete, American Concrete Institute SP-47, 1975.
- 4.58 Performance of Concrete in the Marine Environment, American Concrete Institute SP-65, 1980.
- 4.59 Regourd, M., "Physico-Chemical Studies of Cement Pastes, Mortars, and Concretes Exposed to Sea Water," Performance of Concrete in Marine Environment, ACI Publication SP-65, 1980, pp 63-82.
- 4.60 ACI Committee 201, "Guide to Durable Concrete," Journal of American Concrete Institute, Vol. 74, No. 12, Dec. 1977, pp 573-604.
- 4.61 Haynes, H. H., "Permeability of Concrete in Sea Water," Performance of Concrete in Marine Environment, ACI Publication SP-65, 1980, pp 21-38.
- 4.62 Powers, T. C., Copeland, L. E., Hayes, J. C., and Mann, H. M., "Permeability of Portland Cement Paste," Journal of American Concrete Institute, Proceedings, Vol. 51, Nov. 1954, pp 285-298.
- 4.63 Tuutti, K., Corrosion of Steel in Concrete, Swedish Cement and Concrete Research Institute, 1982.
- 4.64 Browne, R. D., "Mechanisms of Corrosion of Steel in Concrete in Relation to Design, Inspection, and Repair of Offshore and Coastal Structures," Performance of Concrete in Marine Environment, ACI Publication SP-65, 1980, pp 169-204.
- 4.65 ACI Committee 304, "Recommended Practice for Measuring, Mixing, Transporting, and Placing Concrete (ACI 304-73)," American Concrete Institute, 1973, 40 pp.
- 4.66 Browne, R. D., Domone, P. L., and Geoghegan, M. P., "Inspection and Monitoring of Concrete Structures for Steel Corrosion," Offshore Technology Conference, Paper OTC 2802, 1977, pp 571-578.

- 4.67 Humphrys, B. G., "Underwater Repair of Concrete," International Symposium on Behavior of Offshore Concrete Structures, Brest, France, 1980.
- 4.68 Billington, C. J., "The Underwater Repair of Concrete Offshore Structures," Offshore Technology Conference, Paper OTC 3464, 1979, pp 927-937.
- 4.69 Browne, R. D., Doyle, V. J., and Papworth, F., "Inspection and Repair of Offshore Concrete Structures," European Offshore Petroleum Conference and Exhibition, Paper EUR220, 1980, pp 103-117.

1/2" To TRIM

5.0 CONCLUSIONS AND RECOMMENDATIONS

5.1 Conclusions

This report has traced the development of floating concrete structures from first use in the 1800's to fabrication of World Wars I and II concrete ships, to current applications in barges, offshore platforms, floating plants, and harbor and coastal structures. The various applications were discussed with respect to design, construction, materials, and service experience.

1/8" To BIND

The review of recent and current research has revealed significant programs in the use of concrete for marine structures. In the United States, the Portland Cement Association, the American Concrete Institute, the U.S. Navy Civil Engineering Laboratory, and the U.S. Army Engineer Waterways Experiment Station are conducting a number of research programs, some of which deal with concrete in the marine environment. For example, the U.S. Army Corps of Engineers operates an experiment station at Treat Island, Maine, where natural weathering tests have been conducted for over 30 years on concrete materials exposed to the ocean. Such research is necessary to evaluate the long-term durability and performance of concrete structures.

Other countries are also actively pursuing the development of fixed and floating concrete structures. Examples include fixed offshore gravity platforms and oil storage facilities, ships, barges, permanently moored processing plants, and floating oil exploration facilities.

The European community is expending a considerable effort on research dealing with the marine use of concrete. Several of the large programs discussed in this report are:

| <u>Program</u> | <u>Funding</u> |
|---|--------------------------------|
| o United Kingdom's Science Research Council Marine Technology Program (For Projects Listed in Appendix B) | \$1.2 Million |
| o United Kingdom's Concrete in the Oceans Program (For the seven projects of Phase I, Table 4.5) (For the seven projects of Phase II, Table 4.6) | \$0.8 Million \$1.2 Million |
| o Netherlands Industrial Council for Oceanology Program (\$1 M for total StuPOC Program of 11 projects; two projects dealing with concrete are listed in Table 4.9) (\$2.2 M for total MaTS Program of 35 projects; 14 projects dealing with concrete are listed in Table 4.9) | \$3.2 Million |

- o Norwegian/German COSMAR Program §4 Million
(For the four projects listed in Table 4.11)

The review of applications and experience with marine concrete structures, coupled with the knowledge of current research activities, has enabled the project investigators to draw certain conclusions regarding the direction of future research.

This study has also identified certain areas, which, in the opinion of the investigators, do not require further development at this time. More precisely, the state of the art is sufficiently advanced so that future progress in the development of floating concrete structures will not be impeded. Observations are:

Areas with Sufficient Knowledge

1. Strength characteristics of various concrete elements (beams, plates, and shells) are adequately known in the elastic regime.
2. Present knowledge associated with the durability of massive concrete structures seems to be adequate.
3. Current construction techniques appear to be adequate for floating concrete structures whose deadweight/displacement ratio is not a primary concern.
4. Current design procedures which follow existing codes for offshore and floating structures result in designs which satisfy service requirements.
5. Techniques for grouting posttensioned tendons in marine structures appear to be adequate.

The areas requiring future research were identified on the basis that current knowledge is not sufficient to fully utilize concrete as a material for floating marine structures. The format for identifying research needs was chosen to be consistent with the Review and Recommendations for the Interagency Ship Structure Committee's Five-Year Research Plan published annually. The recommendations cross-reference sections and pages in this report which contain related background information and service experience as well as describe recent and current research activities. The following recommendations are also keyed to the work parcels identified in the "Ship Structure Committee Long-Range Research Plan - Guidelines for Program Development" (LRRP) published in May 1982.

Areas Requiring Future Research

1. Project Title: Nondestructive Inspection Techniques for Concrete and Reinforcements

SSC Long-Range Goal Area: Materials - Concrete Damage and Repair

200

Objective: To assess the accuracy and reliability of currently available nondestructive inspection techniques for concrete and reinforcements in the above-water, splash, and submerged zones and examine the potential of future NDE technology.

Related Report Sections: 3.3.6, 3.4, 4.11.2

Related Research Activities: Pages 4.14, 4.17, 4.18, 4.22, 4.24

Related SSC 1982 LRRP Work Parcel: M01 - Damage Assessment in Concrete

2. Project Title: Repair of Marine Concrete Structures

SSC Long-Range Goal Area: Materials: Concrete Damage and Repair.

Objective: To develop repair procedures in the case of damage. These procedures must consider (1) the level of damage below which repairs are not necessary; (2) if work is initiated, the extent of repairs made to concrete and reinforcements; and (3) the repaired structure's strength and serviceability.

Related Report Sections: 3.3.4, 3.3.6, 3.6.2, 4.11.3

Related Research Activities: Pages 4.5, 4.8, 4.9, 4.22, 4.28

Related SSC 1982 LRRP Work Parcel: M02 - Guidelines for Repair of Marine Concrete Structures

3. Project Title: Advances in Concrete Materials Applicable to Marine Structures

SSC Long-Range Goal Area: Materials - Improvements in Reinforced Concrete

Objective: To evaluate the advances being made in materials such as ultrahigh-strength, fiber-reinforced, and polymer and polymer-impregnated concrete.

Related Report Sections: 3.2.4, 3.3.5

Related Research Activities: Pages 4.5, 4.8, 4.9, 4.18, 4.23, Appendix B

Related SSC 1982 LRRP Work Parcel: M03- Evaluation of Alternative Reinforcements in Concrete

4. Project Title: Impact Behavior of Concrete Shells

SSC Long-Range Goal Area: Materials - Improvements in Reinforced Concrete

Objective: To improve the impact resistance of thin- and thick-walled concrete shells subjected to environments such as ship collision and operation in Arctic ice.

Related Report Sections: 3.3.6, 3.4, 3.8.2, 4.9.4

Related Research Activities: Pages 4.5, 4.16, 4.17, 4.19, 4.29, Appendix B

Related SSC 1982 LRRP Work Parcel: M03 - Evaluation of Alternative Reinforcements in Concrete

5. Project Title: Improvements in Deadweight/Displacement Ratio

SSC Long-Range Goal Area: Materials - Improvements in Reinforced Concrete

Objective: To increase the deadweight/displacement ratio of concrete vessels so they will be economically competitive with steel ships for transport of cargo by improving materials, design methods, and construction.

Related Report Sections: 2.2, 3.2.4, 3.7.1, 3.7.2

Related Research Activities: Pages 4.5, 4.9, Appendix B

Related SSC 1982 LRRP Work Parcel: M04 - Development of High Strength-to-Weight Concrete and D15 - Viability of Concrete Hulls

6. Project Title: Fatigue of Marine Concrete Structures

SSC Long-Range Goal Area: Materials - Improvements in Reinforced Concrete

Objective: To define the fatigue characteristic of reinforced concrete in a marine environment considering such influences as crack blockage, rate of loading, hydrostatic pressure, and modes of loading (tension, bending, shear)

Related Report Sections: 3.7.4, 4.8

Related Research Activities: Pages 4.5, 4.15, 4.17, 4.22, 4.39, 4.56, Appendix B

Related SSC 1982 LRRP Work Parcel: M05 - Fatigue in Marine Concrete Structures

7. Project Title: Performance of Concrete in the Splash Zone

SSC Long-Range Goal Area: Materials - Improvements in Reinforced Concrete

Objective: To identify the mechanics of failure of concrete in the splash zone, as well as material properties, design and construction procedures necessary to prevent similar failures in floating concrete structures.

Related Report Sections: 3.3.5, 3.3.6, 3.4, 3.6.2, 4.10

Related Research Activities: Pages 4.8, 4.12, 4.17, 4.27

Related SSC 1982 LRRP Work Parcel: M06 - Corrosion in Concrete and Its Inhibition

8. Project Title: Effects of Bulk Cargo on Concrete Performance

SSC Long-Range Goal Area: Materials criteria

Objective: To evaluate the effect bulk cargo (e.g., hot oil, LPG/LNG, corrosive chemicals) has on the performance of concrete structures.

Related Report Sections: 3.2.6, 3.2.7, 3.7.1, 4.9.3

Related Research Activities: Pages 4.6, 4.13, 4.17, 4.19, 4.22, 4.40, Appendix B

Related SSC 1982 LRRP Work Parcel: None

9. Project Title: Freeze-Thaw Performance of Marine Concrete Structures

SSC Long-Range Goal Area: Materials criteria

Objective: To evaluate the durability of thin-walled shells under repeated freezing and thawing conditions.

Related Report Sections: 3.3.5, 3.9.3, 4.10

Related Research Activities: Pages 4.5, 4.6, 4.8, 4.14, 4.38, Appendix B

Related SSC 1982 LRRP Work Parcel: None

10. Project Title: Facilities for Constructing Large Marine Concrete Structures

SSC Long-Range Goal Area: Fabrication

Objective: To develop a plan for designing, construction, and staffing facilities required for the construction of large concrete structures.

Related Report Sections: 3.2.1, 3.2.2, 3.2.6, 3.5.3.1

Related Research Activities: Pages 4.8, 4.9, 4.18, 4.19

Related SSC 1982 LRRP Work Parcel: None

5.2 Recommendations

The investigators believe that additional research is necessary to further develop the technology required to expand the use of concrete in floating marine structures. Section 5.1 presented brief statements of work for 10 candidate programs which would address technical areas requiring further investigation.

The authors of this report also recognize that, throughout the world, there is a great deal of interest accompanied by major research programs into the use of concrete for both fixed and floating structures. The nature of the problem requires that many of these programs be experimental and of long duration. This substantially increases the cost of such research. Therefore, it is important that future programs of the Ship Structure Committee not duplicate efforts being supported elsewhere, but concentrate on research problems which can be meaningfully addressed with available resources.

If the Ship Structure Committee plans to fund additional research programs in floating concrete technology, the investigators recommend that a workshop with a limited number of participants be held. The objectives of such a workshop would be to:

- (1) Establish a research schedule (based upon the areas identified in this document or the recently published SSC Guidelines for Program Development) which is compatible with the goals of the Ship Structure Committee and with other research activities in the world.
- (2) Explore how the Ship Structure Committee may participate in current and future research programs, both U.S. and foreign, which deal with floating concrete structures in order to obtain the greatest knowledge from the SSC-invested research dollar.
- (3) Establish a technical information committee on floating and fixed concrete structures. The purpose of this committee would be to maintain contact between workshop participants so that information could be exchanged about the various ongoing programs in the world dealing with concrete in the oceans. Since many of the participants would already be members of existing professional committees, this could be accomplished through other organizations such as the American Concrete Institute, the Fédération Internationale de la Précontrainte, or the International Ship Structures Congress.

It is recommended that participation in this workshop include:

U.S. Government

- o Ship Structure Committee
- o National Academy of Sciences



- o Concrete Laboratory, U.S. Army Waterways Experiment Station
- o U.S. Coast Guard
- o U.S. Geological Survey
- o U.S. Maritime Administration
- o U.S. Navy
- o U.S. Naval Underwater Civil Engineering Laboratory

U.S. Nongovernment Organizations

- o American Bureau of Shipping
- o American Concrete Institute
- o Portland Cement Association
- o Representative of Concrete Construction Industry
- o Representative of Naval Architects/Consultants
- o Representative of Petroleum/Gas Industry
- o Representative of University Research Groups

Foreign Organizations

- o Det norske Veritas
- o Fédération Internationale de la Précontrainte
- o Netherlands Industrial Council for Oceanology
- o The University of Trondheim/The Foundation of Scientific and Industrial Research
- o United Kingdom Marine Technology Support Unit/Construction Industry Research and Information Association
- o United Kingdom Science Research Council Marine Technology Directorate

It may not be necessary to have an individual unique to each organization, as many already serve on technical committees of professional societies such as ACI, PCA, SNAME, and FIP.

486-328 (205)
 206 BLANK (205)
 205
 205

APPENDIX A

DEFINITIONS AND NOMENCLATURE

Concrete Technology

Admixture - Material other than water, aggregate, or hydraulic cement, used as an ingredient of concrete and added to concrete before or during its mixing to modify its properties.

Aggregate - Inert material that is mixed with hydraulic cement and water to produce concrete.

Aggregate, Lightweight - aggregate with a dry, loose weight of 70 lb per cu ft or less.

Anchored and Non-End-Anchored Reinforcement - Reinforcement anchored at its ends (not anchored) by means of mechanical devices capable of transmitting the tensioning force to the concrete.

Bonded and Unbonded Reinforcement - Reinforcement bonded (not bonded) throughout its length to the surrounding concrete.

Bonded Tendon - Prestressing tendon that is bonded to concrete either directly or through grouting.

Cables - A group of tendons or the center of gravity (c.g.) of all the tendons.

Circular and Linear Prestressing - Circular prestressing refers to prestressing in round members like tanks and pipes; prestressing in all other members is termed linear.

Concrete - Mixture of portland cement or any other hydraulic cement, fine aggregate, coarse aggregate, and water, with or without admixtures.

Concrete, Structural Lightweight - Concrete containing lightweight aggregate and which has an air-dry unit weight as determined by "Method of Test for Unit Weight of Structural Lightweight Concrete" (ASTM C 567), not exceeding 115 lb per cu ft. In the ACI Code, a lightweight concrete without natural sand is termed "all-lightweight concrete," and lightweight concrete in which all of the fine aggregate consists of normal weight sand is termed "sand-lightweight concrete."

Creep - Time-dependent inelastic deformation of concrete or steel resulting solely from the presence of stress and a function thereof.

Effective Prestress - Stress remaining in concrete due to prestressing after all calculated losses have been deducted, excluding effects of superimposed loads and weight of member; stress remaining in prestressing tendons after all losses have occurred excluding effects of dead load and superimposed load.

End Anchorage - Length of reinforcement, or mechanical anchor, or hook, or combination thereof, beyond point of zero stress in reinforcement; mechanical device to transmit prestressing force to concrete in a post-tensioned member.

Ferrocement - Concrete formed of cement and fine aggregate reinforced by small diameter steel wires well distributed throughout the body of the concrete.

Full and Partial Prestressing - Degree of prestress applied to concrete in which no tension (some tension) is permitted in the concrete under the working loads.

Girder Load, Working Load, Service Load, Cracking Load, and Ultimate Load - GIRDER LOAD: The weight of the beam or girder itself plus whatever weight is on it at the time of transfer. WORKING LOAD OR SERVICE LOAD: The normally maximum total load which the structure is specified or expected to carry. CRACKING LOAD: The total load required to initiate cracks in a prestressed-concrete member. ULTIMATE LOAD: The total load which a member or structure can carry up to total rupture.

Guniting - The trade name for a mixture of sand and cement, applied pneumatically with a pressure gun. It acts as a sealing agent to prevent erosion by air and moisture.

Load Factor - The ratio of cracking or ultimate load to the working or service load (sometimes considering only the live load when so specified).

Plain Concrete - Concrete that does not conform to definition of reinforced concrete.

Portland Cement - A hydraulic cement made by finely pulverizing the clinker produced by calcining to incipient fusion a mixture of argillaceous and calcareous materials.

Posttensioning - Method of prestressing in which tendons are tensioned after concrete has hardened.

Precast Concrete - Plain or reinforced concrete element cast elsewhere than its final position in the structure.

Prestressed and Nonprestressed Reinforcement - Reinforcement in prestressed concrete members, which are elongated (not elongated) with respect to the surrounding concrete.

Prestressed Concrete - Reinforced concrete in which internal stresses have been introduced to reduce potential tensile stresses in concrete resulting from loads.

Pretensioning - Method of prestressing in which tendons are tensioned before concrete is placed.

208

Reinforced Concrete - Concrete containing adequate reinforcement, prestressed or nonprestressed, and designed on the assumption that the two materials act together in resisting forces.

Shrinkage of Concrete - Contraction of concrete due to drying and chemical changes, dependent on time but not directly dependent on stresses induced by external loading.

Slip-Form - A narrow section of formwork that can be easily moved as concrete placing progresses.

Slump - The amount by which a concrete drops below the conical mold height; used to determine the consistency of concrete.

Strength, Design - Nominal strength multiplied by a strength reduction factor.

Strength, Nominal - Strength of a member or cross section calculated in accordance with provisions and assumptions of the strength design method before application of any strength reduction factors.

Strength, Required - Strength of a member or cross section required to resist factored loads or related internal moments and forces.

Stress - Intensity of force per unit area.

Tendon - Steel element such as wire, cable, bar, rod, or strand used to impart prestress to concrete when element is tensioned.

Transfer - The transferring of prestress to the concrete. For pretensioned members, transfer takes place at the release of prestress from the bulkheads; for posttensioned members it takes place after the completion of the tensioning process.

Naval Architecture

Bale Cubic - The cubic capacity of a cargo hold measured to the inside of the frames or cargo battens.

Ballast - Any solid or liquid weight placed in a ship to increase the draft, to change the trim, or to regulate the stability.

Ballasted Concrete Pontoons and Barges - Pontoon hulls which are towed to an inshore or offshore location and ballasted down so that the pontoon is sitting on the seabed.

Barge - A large cargo-carrying craft which is towed or pushed by a tug.

Beam or Breadth, Molded - The maximum breadth of the hull measured between the inboard surfaces of the side shell plating of flush-plated ships, or between the inboard surfaces of the inside strakes of lap seam-plated vessels.

Block Coefficient - Ratio of the volume of displacement of the molded form of a vessel up to a given waterline to the volume of a rectangular solid, the length, breadth, and draft of which are equal to the waterline length, the molded breadth at that waterline, and the molded mean draft of the vessel up to that waterline.

Boat - A small water craft.

Bulkhead - A term applied to the vertical partition walls which subdivide the interior of a ship into compartments or rooms. Bulkheads which contribute to the strength of a vessel are called strength bulkheads, those which are essential to the watertight subdivision are watertight or oiltight bulkheads, and gastight bulkheads serve to prevent the passage of gas or fumes.

Buoy - An anchored or moored floating object.

Deadweight - The carrying capacity of a ship at any draft and water density. Includes weight of cargo, fuel, lubricating oil, fresh water in tanks, stores, passengers and baggage, crew and their effects.

Depth, Molded - The vertical distance from the molded baseline to the top of the freeboard deck beam at side, measured at midlength of the ship.

Displacement - The volume of fluid which is displaced by a floating body.

Draft - The depth of the ship below the waterline measured vertically to the lowest part of the hull, propellers, or other reference point. When measured to the lowest projecting portion of the vessel, it is called the extreme draft; when measured at the bow, it is called forward draft; and when measured at the stern, the after draft; the average of the forward draft and the after draft is the mean draft; and the mean draft when in full load condition is the load draft.

Fixed Platform - A drilling, producing or processing structure fixed to the seabed by piles and/or gravity and extending above sea level.

Free-Floating Hulls - Barges and pontoons used for cargo transportation and hulls that are not permanently moored at one location.

Graving Dock - A structure for taking a ship out of water, consisting of an excavation in the shoreline to a depth at least equal to the draft of ships to be handled, closed at the water side end by a movable gate, and provided with large capacity pumps for removing water; blocks support the ship when the dock is pumped out.

Hogging - Straining of a ship that tends to make the bow and stern lower than the middle portion.

Ketch - A fore-and-aft-rigged sailing vessel.

Length, Overall - The extreme length of a ship measured from the foremost point of the stem to the aftermost part of the stern.

Length Between Perpendiculars - The length of a ship between the forward and after perpendiculars. The forward perpendicular is a vertical line at the intersection of the fore side of the stern and the summer load waterline. The after perpendicular is a vertical line at the intersection of the summer load line and the after side of the rudder post or sternpost, or the centerline of the rudder stock if there is no rudder post or sternpost.

Lighter - A large boat or barge, usually having a flat bottom, which is used to load or unload ships not lying at wharves or to carry freight across a harbor.

Metacenter - The intersection of a vertical line drawn through the center of buoyancy of a slightly listed vessel with the centerline plane.

Metacentric Height - The distance from the metacenter to the center of gravity of a ship. If the center of gravity is below the metacenter, the vessel is stable.

Permanently Moored Floating Hulls - Floating process plants, mooring and roll-on roll-off cargo terminals, floating docks, floating bridges, marina pontoons, etc.

Pontoon - A low, flat-bottomed ship, similar to a barge, used to carry machinery or make temporary bridges.

Quay - A stretch of paved bank or a solid artificial landing place beside navigable water for convenience in loading and unloading ships.

Sagging - Straining of a ship that tends to make the middle portion lower than the bow and stern.

Sea Chest - An enclosure, attached to the inside of the underwater shell and open to the sea, fitted with a portable strainer plate. A sea valve and piping connected to the sea chest passes sea water into the ship for cooling, fire, or sanitary purposes. Compressed air or steam connections may be provided to remove ice or other obstructions.

Semi-submersible - Floating marine platform structure that can be partially submerged for added stability.

Ship - Any large vessel which travels over the sea, river, or lakes.

Sloop - A small boat with a single mast and a jib.

APPENDIX B

UNITED KINGDOM SCIENCE RESEARCH COUNCIL
MARINE TECHNOLOGY PROGRAM (From [4.8])

Project Title: PORE PRESSURE EFFECTS IN CONCRETE TRIAXIAL TESTS
SRC Ref: GR/A/7809.6
Location: University of Cambridge

Overall Aims and Use of Results: To investigate the effects of pore pressure on the strength and deformation of concrete as an aid to the design of structures in deep water.

Links With Other Relevant Work: The work will be coordinated with the concrete program at Imperial College London.

Current Work Program: A triaxial testing apparatus for concrete cylinders will be constructed and a short test program measuring strength and deformation will use specimens of different water content. It is hoped that pore pressure will be measured. The tests on cylinders will be accompanied by tests on water penetration and followed by implosion testing of hollow vessels.

Project Title: CONCRETE FOR MARINE TRANSPORT AND STORAGE OF CRYOGENIC LIQUIDS
SRC Ref: GR/A/9277.1
Location: Sunderland Polytechnic

Overall Aims and Use of Results: To study the application of concrete in the marine transport and storage of cryogenic liquids. Certain aspects of design will be investigated and an experimental program undertaken to assess materials' behavior under a range of conditions and its influence on design. Economic factors will also be considered.

Links With Other Relevant Work: Correlation will be made with specific work at Imperial College, and coordination is anticipated with other relevant aspects of the Marine Technology program. It is also intended to relate the work so far as possible to appropriate programs of Construction Industry Research and Information Association - Underwater Engineering Group (UEG) and other organizations.

Current Work Program: There are three main elements: materials, design, and economics. Materials is concerned with the study of mechanical and thermal properties and creep and their relation to design practice. Design deals with factors affecting safety which are peculiar to LNG. Economics involves a critical examination of the specific economical advantages and disadvantages of employing concrete for the particular use under study.

Project Title: POLYMERIC REINFORCED CEMENT AGGREGATES
SRC Ref: GR/A/77839
Location: North Western Universities Consortium
University of Salford

Overall Aims and Use of Results: To improve cement for applications in sea water. Particularly,

- (a) to increase tensile strength so that weight of large structures can be decreased and more can be made of precasting techniques;
- (b) to identify a rapid setting concrete grout;
- (c) to explore methods to minimize shrinkage.

Links With Other Relevant Work: The possibility of collaboration with the Department of Engineering, Manchester University, is being looked into. The Civil Engineering Department at Salford University is also interested in developing fiber-reinforced cement, and collaboration has been arranged with them, particularly as regards access to their testing facilities. Several schools of research (Cement and Concrete Association, Oxford, and Aberdeen University), are known to be working in the general area, but are not using the approach outlined here. Close contacts have been established with these workers so as to avoid unnecessary duplication in the work.

Current Work Program: (1) Laboratory measurement of adsorption properties and strength (to relate porosity to strength of samples which have been stored in seawater), setting time, and shrinkage for samples:

- (a) with polymer chains introduced by adding soluble polymers during hydration;
- (b) with inorganic additives which change morphology and organic additives;
- (c) with added fibers capable of cross-linking to the cement matrix;
- (d) prepared by unconventional methods.

Work on 1a and 1b has begun with earlier funding.

(2) Electron microscopy and thermal analysis using a Calvet microcalorimeter of samples as in (1) above to assess chemical changes during ageing.

Testing of large structures using facilities at Plymouth Polytechnic.

Project Title: EARLY-AGE PROPERTIES OF CONCRETE FOR OFFSHORE STRUCTURE
CONSTRUCTION
SRC Ref: GR/B/2181.2
Location: London Centre
University College

Overall Aims and Use of Results: To provide data on early hardening rates of concrete mixes as modified by various types of commercial admixtures with a view to improving the quality control of concrete offshore construction.

Links With Other Relevant Work: No similar research programs, but close contacts exist with the Cement and Concrete Association who have other programs concerned with early-age properties of concrete.

Current Work Program: The work will be carried out by monitoring the progressive hardening of mortars extracted from appropriate concrete mixes two days after mixing. Hardening of the mortars will be monitored by automatic measurement of ultrasonic pulse velocity in a test system developed over the past year. The ultrasonic pulse velocity variations will be correlated with standard methods of measuring hardening and with the rate of heat evolution using a conduction calorimeter. The parameters to be studied will be water/cement and aggregate/cement ratios, temperature, the effect of commercial retarding admixtures and pulverized fuel ash.

Project Title: BEHAVIOUR OF CONCRETE UNDER DIFFERENT TEMPERATURES AND IN VARIOUS ENVIRONMENTS

SRC Ref: GR/B/2181.2

Location: London Centre
Imperial College of Science and Technology

Overall Aims and Use of Results: To establish the efficiency of concrete as a containment material for liquid natural gas (LNG) and hydrocarbons at elevated temperatures. To investigate the change in properties of concrete in service condition of containment.

Links With Other Relevant Work: This work will run in close cooperation with Sunderland Polytechnic's Offshore Group who are studying the behavior of concrete under cryogenic conditions.

Current Work Program: For each of the substances contained, a series of tests will be carried out using a factorial method of experimental design. The principal factors affecting structural concrete containing these fluids comprise: cement content, type of aggregate, water-cement ratio, type of cement, air entraining agents, cement replacement additives, initial moisture condition, curing history, surface coating, and polymer impregnation. Specimens will be placed in environments simulating conditions in LNG containers and crude oil storage cells. The strength and deformational behavior under steady state and after thermal cycling will be measured nondestructively and destructively. To assess the boiloff/seepage of the fluids, permeability of the concrete to these substances will be measured using a modified form of the cryogenic equipment developed at ICST and a pressurized crude oil cell.

Project Title: DURABILITY OF NORMAL AND SPECIAL CONCRETES
SRC Ref: GR/B/2181.2
Location: London Centre
Imperial College of Science and Technology

Overall Aims and Use of Results: To assess the long-term performance of various concretes under conditions simulating those in a marine environment with particular reference to current specifications for offshore structures.

Links With Other Relevant Work: Cooperation with Cement and Concrete Association, Building Research Establishment, and Taylor Woodrow in the Department of Energy's Program "Concrete in the Oceans."

Current Work Program: A factorial experimental design approach has been adopted to allow nine parameters at three different levels to be investigated such that the optimum information will be obtained from the minimum number of tests. The parameters which are being investigated include cement content, type of aggregate, water-cement ratio, type of cement, content of entrained air, content of pozzalanic admixture, salinity of solution, and curing history. Prismatic specimens with and without steel reinforcement will be subjected to freeze/thaw and wet/dry cycles in a saline environment in specially designed environmental chambers and in test rigs designed for automatic wetting and accelerated drying. Performance will be measured at regular time intervals by nondestructive methods and tests to failure.

Project Title: BEHAVIOR OF COMPOSITE MATERIALS
SRC Ref: GR/B/2181.2
Location: London Centre
Imperial College of Science and Technology

Overall Aims and Use of Results: To study mechanisms of damage and of healing of cement in terms of the microstructure so as to guide the development of repair techniques using fiber-reinforced resins and to lead to the development of higher strength concretes.

Links With Other Relevant Work: This work is linked with the investigation of the durability of concretes in marine environments and related to the Department of Energy program on the use of fiber-reinforced resins for repairs to concrete structures.

Current Work Program: The work involves studies, at the microstructural level, of the mechanisms of the setting of cement, or the mechanisms of damage and of healing of cement, and of the effect of polymeric impregnation of cement upon the subsequent adhesion of fiber-reinforced resin patches. In parallel with these, mechanical tests involve the determination of fracture mechanics parameters of the cement and concrete substrate materials, and measurement of the stresses and strains in patches of fiber-reinforced materials applied to the substrates.

Project Title: INTERACTION BETWEEN CORROSION AND FATIGUE IN REINFORCED
CONCRETE AND IN PRESTRESSED CONCRETE
SRC Ref: GR/B/2184.3
Location: University of Glasgow

Overall Aims and Use of Results: To assess the effect of seawater on the fatigue behavior of reinforced concrete and prestressed concrete members and to study the mechanisms of the fatigue deterioration process and, hence, to provide relevant information to industry on this aspect of the integrity of offshore concrete structures.

Links With Other Relevant Work: Continued contact is maintained with the construction industry, certification bodies and research organizations, particularly with those involved in the Concrete in the Oceans Program. There is representation on the European Working Party on Techniques and Standards for Fatigue Testing of Reinforced Concrete in the Offshore Environment.

Current Work Program: Studies on reinforced concrete:

- (a) To continue the current series of fatigue tests, mainly at 0.15 Hz, but with some at 5 Hz, in seawater and air at one high stress amplitude.
- (b) To undertake microscopical and microanalytical examination of failed samples to elucidate mechanisms of fatigue failure.
- (c) To modify rigs to enable reverse-bending fatigue tests to be carried out.
- (d) To develop a rig to facilitate fatigue tests at high pressure.
- (e) To extend the work to cover other relevant variables which will include lower stress amplitudes, elevated pressure and possibly degree of aeration, temperature, and loading parameters, but with actual priorities being determined by the knowledge obtained in the current phase of the work.

Project Title: RESPONSE OF PRESTRESSED CONCRETE SLABS TO IMPACT LOADING
SRC Ref: GR/B/2181.2
Location: London College
Imperial College of Science and Technology

Overall Aims and Use of Results: To investigate the response of prestressed concrete slabs and shells to impact loading, and recommend procedures for estimating the effect of impacts on fixed and floating prestressed concrete marine structures.

Links With Other Relevant Work: None

Current Work Program: The work will include both experimental and theoretical investigation. Initially the emphasis will be on the experimental work since there is a lack of data. Specimens will be loaded by a dropped mass. Transient effects will be measured including the

(217)

contact load. The effects of variation of the striker, slab or shell characteristics, and of the contact zone stiffness will be investigated. Theoretical studies will continue in parallel with this work.

Project Title: HIGH-PERFORMANCE CONCRETE ELEMENTS
SRC Ref: GR/A/7809.6
Location: London Centre
Imperial College of Science and Technology

Overall Aims and Use of Results: To develop techniques for the use of multiaxially reinforced and prestressed concrete elements with particular reference to their use in massive offshore structures.

Links With Other Relevant Work: The project will maintain strong links with consulting engineers and contractors involved in the offshore field and with the Naval Research Center, Port Hueneme, USA, where some experimental work has been carried out on the effects of hydrostatic pressure on the performance of spherical and cylindrical shells.

Current Work Program: The project will consist of both theoretical and experimental investigations. In the initial phase (1), small scale reinforced and prestressed concrete specimens will be tested under various multiaxial loading conditions and the results compared with those predicted by existing multiaxial deformational and strength data. The results obtained will be used to plan the main series of tests (phase 2) on large scale multiaxially reinforced and prestressed elements which will be tested under various conditions simulating those in service, paying particular attention to the effects of reversed loading and large hydrostatic pressure. Finally, in phase 3, criteria will be proposed for the design of elements for sub-sea structures and for relevant portions of floating or gravity platforms.

Project Title: CYCLIC LOADING OF CONCRETE STRUCTURES
SRC Ref: GR/B/2181.2
Location: London Centre
Imperial College of Science and Technology

Overall Aims and Use of Results: To investigate the response of concrete members subjected to reversible cyclic loading, leading to improved design methods for offshore structures.

Links With Other Relevant Work: The work began in October 1977 with a pilot study with the following objectives:

- (1) Choice of suitable sections for the main testing program
- (2) Completion of preliminary tests
- (3) Development of statistical and individual analysis of results.

Current Work Program: The main testing program will involve a more extensive test program, with variation of concrete strength, steel area, prestressing force and cross-sectional shape, in order to determine optimum design.

APPENDIX C

BIBLIOGRAPHY

Code of Abbreviations for Bibliography

| | |
|--------|---|
| ACI | AMERICAN CONCRETE INSTITUTE |
| ASCE | AMERICAN SOCIETY OF CIVIL ENGINEERS |
| ASME | AMERICAN SOCIETY OF MECHANICAL ENGINEERS |
| BSRA | BRITISH SHIP RESEARCH ASSOCIATION |
| CIA | CONCRETE INSTITUTE OF AUSTRALIA |
| CEB | COMITE EURO-INTERNATIONAL DU BETON |
| DNV | DET NORSKE VERITAS |
| DTMB | DAVID TAYLOR MODEL BASIN (NAVAL SHIP RESEARCH AND DEVELOPMENT CENTER) |
| IASS | INTERNATIONAL ASSOCIATION FOR STEEL AND SPATIAL STRUCTURES |
| IEEE | INSTITUTE OF ELECTRICAL AND ELECTRONICS ENGINEERS |
| IME | INSTITUTE OF MARINE ENGINEERS |
| INA | INSTITUTE OF NAVAL ARCHITECTS |
| ISP | INTERNATIONAL SHIPBUILDING PROGRESS |
| ISSC | INTERNATIONAL SHIP STRUCTURES CONGRESS |
| JPC | JOURNAL OF PRESTRESSED CONCRETE |
| JPT | JOURNAL OF PETROLEUM TECHNOLOGY |
| JSNA | JOURNAL OF THE SOCIETY OF NAVAL ARCHITECTS |
| JSNAJ | JOURNAL OF THE SOCIETY OF NAVAL ARCHITECTS OF JAPAN |
| JSR | JOURNAL OF SHIP RESEARCH |
| MESJ | MARINE ENGINEERS SOCIETY OF JAPAN |
| MTS | MARITIME TECHNOLOGY SERVICE |
| NECIES | NORTH EAST COAST INSTITUTE OF ENGINEERS AND SHIPBUILDERS |
| NSRDC | NAVAL SHIP RESEARCH AND DEVELOPMENT CENTER (DAVID TAYLOR MODEL BASIN) |

Smart Model 2017

CODE OF ABBREVIATIONS FOR BIBLIOGRAPHY

NSRDL NAVAL SHIP RESEARCH AND DEVELOPMENT LABORATORY
NTIS NATIONAL TECHNICAL INFORMATION SERVICE
OTC OFFSHORE TECHNOLOGY CONFERENCE
PCA PORTLAND CEMENT ASSOCIATION
PCI PRESTRESSED CONCRETE INSTITUTE
RINA ROYAL INSTITUTION OF NAVAL ARCHITECTS
SNAME SOCIETY OF NAVAL ARCHITECTS AND MARINE ENGINEERS
SSC SHIP STRUCTURE COMMITTEE
TINA TRANSACTIONS OF THE INSTITUTE OF NAVAL ARCHITECTS

957

486-328 (220)

(220)

SUBJECT: REINFORCED CONCRETE APPLICABLE TO FLOATING MARINE STRUCTURES

1. ABRAMS, M.S., "PERFORMANCE OF CONCRETE STRUCTURES EXPOSED TO FIRE", 9TH NATIONAL SAMPE TECHNICAL CONFERENCE, ATLANTA, GA., VOL. 9, OCT. 1977, (24 REF).
2. ALEXANDER, D.J., "NEWER TECHNIQUES IN THE CONSTRUCTION OF PRE-STRESSED CONCRETE BARGES AND PRESTRESSED FERROCEMENT VESSELS," J. FERROCEMENT, VOL. 4, NO. 6, PP 2-10, 13-15, OCT-NOV. 1975.
3. ALEXANDER, D., "THE LAUNCHING OF A 22 METER HIGH TENSILE WIRE REINFORCED FIBROUS FERROCEMENT TUG FOR LOG HAULING DUTIES," JOURNAL OF FERROCEMENT, VOL. 9, NO. 1, PP 41-42, JANUARY 1979, (0 REF).
4. AL KHALAF, M.N., AND PAGE, C.L., "STEEL/MORTAR INTERFACES: MICRO-STRUCTURAL FEATURES AND MODE OF FAILURE," CEMENT AND CONCRETE RESEARCH, VOL. 9, PP 197-208, 1979, (19 REF).
5. AMIRIKIAN, A., "ANALYSIS AND DESIGN OF FLOATING DRYDOCKS," TRANS. SNAME, VOL. 65, PP 307-361, 1957 (0 REF).
6. ANDERSON, A.R., "A 65,000-TON PRESTRESSED CONCRETE FLOATING FACILITY FOR STORAGE OF LPG," MARINE TECHNOLOGY, VOL. 15, NO. 1, PP 14-26.
7. ANDERSON, A.R., "CONCRETE VESSEL IS STAR OF FIRST TOTALLY OFFSHORE LPG FACILITY," CIVIL ENG. (NY), VOL. 46, NO. 4, PP 58-60, APRIL 1976.
8. ANDERSON, A.R., "DESIGN AND CONSTRUCTION OF A 375,000 BBL PRE-STRESSED CONCRETE FLOATING LPG STORAGE FACILITY FOR THE JAVA SEA," PRGC. DTC, VOL. 1, PP 673-688, 1976, (8 REF).
9. ANDERSON, A.R., "FLOATING LPG STORAGE FOR JAVA SEA," OCEAN ENGINEERING, VOL. 10, NO. 3, NOVEMBER 1976, (1 REF).
10. ANDERSON, A.R., "PRESTRESSED CONCRETE FLOATING STRUCTURES, (STATE OF THE ART)," SNAME, PP 123-144, 1975, (6 REF).
11. ANDERSON, A.R., "WORLD'S LARGEST PRESTRESSED LPG FLOATING VESSEL," J. PRESTRESSED CONCRETE INSTITUTE, VOL. 22, NO. 1, PP 12-31, JANUARY-FEBRUARY 1977.
12. ANDERSON, A.R., "PERFORMANCE OF PRESTRESSED CONCRETE FLOATING STRUCTURES", CONCRETE SHIPS AND FLOATING STRUCTURES CONVENTION, ROTTERDAM, NOV. 1979.
13. ANDERSON, A.R., "THE DEVELOPMENT OF CONCRETE SHIPS AND VESSELS", CONCRETE SHIPS AND FLOATING STRUCTURES CONFERENCE, BERKELEY, SEPT. 1975.

SUBJECT: REINFORCED CONCRETE APPLICABLE TO FLOATING MARINE STRUCTURES

14. "ANDOC'S TWO-CAISSON GRAVITY PLATFORM," CONCRETE PUBLICATION NO. 1, VOL. 11, P 33, JAN 1977, (O REF).
15. ANDREW, C.E., "PROBLEMS PRESENTED BY THE LAKE WASHINGTON FLOATING BRIDGE," PRBC. ACI, VOL. 37, PP 253-268, SEPT. 1940 - NOV. 1941, (O REF).
16. "AN INNOVATION IN OFFSHORE CONCRETE," CONCRETE PUBLICATION NO. 7, VOL. 12, PP 35-39, JULY 1978, (O REF).
17. ANON., "AND NOW - A CONCRETE GAS TANKER," MOTOR SHIP, VOL. 57, NO. 677, PP 88-91, DECEMBER 1976.
18. ANON., "BACKGROUND PAPERS ON SEAFLOOR ENGINEERING, VOL. 1, NATIONAL NEEDS IN SEAFLOOR ENGINEERING, VOLUME 2: STATE-OF-THE-ART IN SEAFLOOR ENGINEERING," PAPER PREPARED FOR NATIONAL RESOURCE COUNC., COMMITTEE ON SEAFLOOR ENG., WASHINGTON, D.C., VOL. 2, P 636, 1975.
19. ANON., "CONCRETE DUE TEST AS BARRIER IN MARINE LNG SERVICE," OIL GAS JOURNAL, VOL. 74, NO. 42, PP 64-66, OCTOBER 18, 1976.
20. ANON., "CONCRETE INSTITUTE OF AUSTRALIA, 7TH BIENNIAL CONFERENCE, 1975," MELBOURNE, AUGUST 20-22, 1975, PUBL. BY CIA., 1975.
21. ANON., "CONCRETE TECHNOLOGY GETS A Foothold ON BRAZIL'S URBARANA FIELD," INT. PET. TIMES, VOL. 82, NO. 2072, PP 21-23, APRIL 1, 1978.
22. ANON., "DOUBLE BARRIER KELLGAS TANK USES CONCRETE, FLEXIBLE MEMBRANE," PIPELINE GAS JOURNAL, VOL. 199, NO. 11, P 69-72, SEPTEMBER 1972.
23. ANON., "FIRST SELF-PROPELLED CONCRETE LNG CARRIER," GAS WORLD GAS JOURNAL, VOL. 181, NO. 4696, PP 618-620, NOVEMBER 1976.
24. ANON., "FOR LNG - A CONCRETE ANSWER," ENERGY DIG., VOL. 5, NO. 6, PP 12-15, DECEMBER 1976.
25. ANON., "LNG TRANSPORT COSTS CUT BY CONCRETE," PET. REV., VOL. 31, NO. 367, PP 15-16, JULY 1977.
26. ANON., "USE OF CONCRETE IN THE NEW TERRASTORE UNDERGROUND STORAGE SYSTEM," PET. REV., VOL. 31, NO. 367, PP 13-14, JULY 1977.
27. ANON., "WORLD'S LARGEST LNG STORAGE TANKS UNDER CONSTRUCTION," PIPELINE GAS JOURNAL, VOL. 199, NO. 11, P 62-64, SEPTEMBER 1972.
28. APELT, C.J., AND MACKNIGHT, A., "DESIGN FOR WAVE ACTION ON LARGE OFFSHORE BERTH STRUCTURES," MARINE TECHNOLOGY SOCIETY, JOURNAL OF MTS, VOL. 12, P 8.

SUBJECT: REINFORCED CONCRETE APPLICABLE TO FLOATING MARINE STRUCTURES

29. "API RECOMMENDED PRACTICE FOR PLANNING, DESIGNING AND CONSTRUCTING FIXED OFFSHORE PLATFORMS", AMERICAN PETROLEUM INSTITUTE RP2A, 9TH EDITION, 1977.
30. ARAFAT, M.Z., "GIANT PRECAST PRESTRESSED LNG STORAGE TANKS AT STATEN ISLAND," JPC INSTITUTE, VOL. 20, NO. 3, PP 22-33, MAY-JUNE 1975.
31. ARNOLD, S.R., "CONCRETE AFLOAT - BRITISH STYLE," ACI JOURNAL, V. 75, NO. 10, PP N17-N18, OCTOBER 1978.
32. ARNOLD, G., "HERVORRAGENDE SPANNBETON-BAUWERKE DES TIEFBAUS: MEERWASSERBAUTEN, ATOMKRAFTWERKE, BEHAELTER UND TUNNEL," BETON UND STAHLBETONBAU, HEFT 2, 1975, (3 REF).
33. ARTHUR, P.D., EARL, J.C., AND HODGKISS, T., "FATIGUE OF REINFORCED CONCRETE IN SEAWATER," CONCRETE, PUBLICATION NO. 5, PP 26-30, MAY 1979, (8 REF).
34. ARUP, H., "GALVANIZED STEEL IN CONCRETE," MATER. PERFORMANCE, VOL. 18, NO. 4, PP 41-44, APRIL 1979.
35. "A \$20 MILLION 'ISLAND' FOR EKOFISK," OCEAN INDUSTRY, VOL. 6, NO. 7, P 21, 1971, (0 REF).
36. BARFOOT, R.J., "A CREEKFUL OF CONCRETE BOATS," CONCRETE PUBLICATION NO. 5, VOL. 11, P 19, MAY 1977, (0 REF).
37. BAUDAIS, D.J., WATTS, J.S., AND MASTERSON, D.M., "A SYSTEM FOR OFFSHORE DRILLING IN THE ARCTIC ISLANDS," PROC. OTC, VOL. III, PP 31-43, 1976, (5 REF).
38. BAUGH, I., "SOME COMMENTS ON THE DESIGN AND CONSTRUCTION OF FERROCEMENT DECKS," JOURNAL OF FERROCEMENT, VOL. 8, NO. 3, PP 195-201, JULY 1978, (3 REF).
39. BAUGH, I, AND BOWEN, G.L., "CORROSION IN FERROCEMENT," J. FERROCEMENT, VOL. 5, NO. 4, PP 13-27, 1975.
40. BAZANT, Z.P., "PHYSICAL MODEL FOR STEEL CORROSION IN CONCRETE SEA STRUCTURES - APPLICATION," ASCE J., STRUCT. DIV., VOL. 105, NO. 6, PP 1155-1166, JUNE 1979, (4 REF).
41. BAZANT, Z.P., "PHYSICAL MODEL FOR STEEL CORROSION IN CONCRETE SEA STRUCTURES - THEORY," ASCE J., STRUCT. DIV., VOL. 105, NO. 6, PP 1137-1153, JUNE 1979, (37 REF).
42. BEN-YAIR, M., "THE EFFECT OF CHLORIDES ON CONCRETE IN HOT AND ACID REGIONS," CEMENT AND CONCRETE RESEARCH, VOL. 4, PP 405-416, PERGAMON PRESS, INC., 1974, (15 REF).

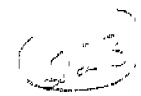

SUBJECT: REINFORCED CONCRETE APPLICABLE TO FLOATING MARINE STRUCTURES

43. BERTRANDY, R., "CORROSION A LA MER DE STRUCTURES EN BETON ARME ET PRECONTRAINTE, (CORROSION AT SEA OF REINFORCED AND PRESTRESSED CONCRETE STRUCTURES," ANNALES DE L'INSTITUT TECHNIQ. DU BATIMENT TRAVAUX PUBLIC, NO 360, PP 61-75.
44. SESLAC, J., BJEGOVIC, D., HRANILOVIC, M. "DURABILITY OF REINFORCED CONCRETE ELEMENTS AND STRUCTURES PLACED BY TREMIE IN THE SEA AND WITH SLIPFORMS BY THE SEA", PERFORMANCE OF CONCRETE IN MARINE ENVIRONMENT, ACI SPECIAL PUBLICATION SP-65, 1980.
45. BEZUKLADOV, V.F., AMELYANOVICH, K.K., VERBITSKY, V.D., AND BOGDYAV-LENSKI, L.P., "REINFORCED CONCRETE SHIP HULLS: DESIGN, STRENGTH AND CONSTRUCTION TECHNOLOGY", " KORPUSA SUDDV IZ ARMOTSEMENTA: KONSTRUKTSIYA, PROCHNOST I TEKHNLOGIYA POSTROYKI", 186 PP, 88 FIG., 29 TAB., SHIPBUILDING PUBLISHING HOUSE, LENINGRAD, 1968, (55 REF).
46. BEZUKLADOV, V.F., AMELYANOVICH, K.K., VERBITSKI, V.D., AND BOGDYAV-LENSKI, L.P., "SHIP HULLS MADE OF REINFORCED CONCRETE (DESIGN, STRENGTH, AND CONSTRUCTION TECHNOLOGY)," NAVAL SHIP SYSTEMS COMMAND, WASHINGTON, D.C., AD-680042, 239 PP, NOVEMBER 1968, NTIS DEFENSE DOCUMENTATION CENTER.
47. "BIBLIOGRAPHIC LIST ON FERROCEMENT," JOURNAL OF FERROCEMENT, VOL. 7, NO. 1, JULY 1977.
48. "BIBLIOGRAPHIC LIST ON FERROCEMENT, PART II," JOURNAL OF FERROCEMENT, VOL. 7, NO. 2, OCTOBER 1977.
49. "BIBLIOGRAPHIC LIST ON FERROCEMENT, PART III," JOURNAL OF FERROCEMENT, VOL. 8, NO. 1, JANUARY 1978.
50. "BIBLIOGRAPHIC LIST ON FERROCEMENT, PART IV," JOURNAL OF FERROCEMENT, VOL. 8, NO. 2, APRIL 1978.
51. "BIBLIOGRAPHIC LIST ON FERROCEMENT, PART V," JOURNAL OF FERROCEMENT, VOL. 8, NO. 3, JULY 1978.
52. "BIBLIOGRAPHIC LIST ON FERROCEMENT, PART VI," JOURNAL OF FERROCEMENT, VOL. 8, NO. 4, OCTOBER 1979.
53. "BIBLIOGRAPHIC LIST ON FERROCEMENT, PART VII," JOURNAL OF FERROCEMENT, VOL. 9, NO. 1, JANUARY 1979.
54. "BIBLIOGRAPHIC LIST ON FERROCEMENT, PART VIII," JOURNAL OF FERROCEMENT, VOL. 9, NO. 2, APRIL 1979.
55. BILLINGTON, C.J., "THE UNDERWATER REPAIR OF CONCRETE OFFSHORE STRUCTURES," PROC. OTC, VOL. II, NO. 3464, PP 927-937, 1979, (15 REF).



SUBJECT: REINFORCED CONCRETE APPLICABLE TO FLOATING MARINE STRUCTURES

56. BILLINGTON, C., AND LEWIS, G.H.G., "THE STRENGTH OF LARGE DIAMETER GROUTED CONNECTIONS," PROC. OTC, VOL. I, NO. 3083, PP 291-302, 1978, (4 REF).
57. BLANKS, R.F., AND ASCE, M., "MODERN CONCEPTS APPLIED TO CONCRETE AGGREGATE," ASCE TRANS., VOL. 115, PP 403-431, 1950, (47 REF).
58. BONDURYANSKII, Z.P., DYACHKOV, M.A., AND MELAMED, E.E., "SEAGOING FERROCONCRETE SHIPS- HULL DESIGN," NAVAL SHIP SYSTEMS COMMAND WASHINGTON, D.C., SCIENTIFIC DOCUMENTATION DIVISION (404028), APRIL 1969.
59. BOON, C., GOUVENOT, D., GAU, M., AND GEFFRIAUD, J.P., "STABILITY OF GRAVITY-TYPE PLATFORMS BY FILLING UNDER THE RAFT," PROC. OTC. VOL. IV, NO. 2963, PP 39-44, 1977, (2 REF).
60. BOOTH, S.H., AND VANCE, R.W., "APPLICATIONS OF CRYOGENIC TECHNOLOGY, VOLUME 8, 1976," CRYOG. SOCIETY OF AM. MINI-CONF., PUBL. BY SCHLUMBERGER INT. INC., FLUSHING, NEW YORK, P. 344, 1976.
61. BOSCH, V.D.V., "PERFORMANCE OF MORTAR SPECIMENS IN CHEMICAL AND ACCELERATED MARINE EXPOSURE", PERFORMANCE OF CONCRETE IN MARINE ENVIRONMENT, ACI SPECIAL PUBLICATION SP-65, 1980.
62. BRAUER, F.E., "STATE-OF-THE-ART SURVEY OF FERROCEMENT," NSRDL ANNAPOLIS, MARYLAND (404 417), REPT. NO. NSRDL/A-8-529, JANUARY 1971.
63. BROUGHTON, P., "OFFSHORE GRAVITY BASED OIL PRODUCTION PLATFORM INTERACTION WITH THE SEA BED," PROC. OTC, VOL. III, PP 337-398, 1975, (29 REF).
64. BROUGHTON, P., "THE INTERACTION OF CELLULAR CONCRETE RAFTS WITH THE SEABED", PROC. OFF-SHORE STRUCTURES, PP 75-84, LONDON, OCT. 1974.
65. BROWNE, R.D., DOMONE, P.L., GEDGHEGAN, M.P., "INSPECTION AND MONITORING OF CONCRETE STRUCTURES FOR STEEL CORROSION," PROC. OTC, VOL. I, PP 571-580, 1977, (21 REF).
66. BROWNE, R.D., "EVALUATING NORTH SEA CONCRETE STRUCTURES" - OCEAN INDUSTRY, PP 63-65, FEB. 1980, (3 REF).
67. BROWNE, R.D., DOMONE, P.L.J., "THE LONG TERM PERFORMANCE OF CONCRETE IN THE MARINE ENVIRONMENT", PROC. OFF-SHORE STRUCTURES, PP 49-60, LONDON, OCT. 1974.
68. BROWNE, R.D., "MECHANISMS OF CORROSION OF STEEL IN CONCRETE IN RELATION TO DESIGN, INSPECTION, AND REPAIR OF OFFSHORE AND COASTAL STRUCTURES", PERFORMANCE OF CONCRETE IN MARINE ENVIRONMENT, ACI SPECIAL PUBLICATION SP-65, 1980.



SUBJECT: REINFORCED CONCRETE APPLICABLE TO FLOATING MARINE STRUCTURES

69. BRUUN, P., "NORTH SEA OFFSHORE STRUCTURES," OCEAN ENGINEERING, VOL. 3, NO. 5, PP 361-373, OCTOBER 1976, (10 REF).
70. BUCKMAN, D., "FRIGG FIELD PLATFORM SET ON SITE, SECOND PLATFORM RAFT CHRISTENED," OCEAN INDUSTRY, VOL. 10, NO. 11, 1975, (0 REF).
71. BUCKMAN, D., "ONE-ATMOSPHERE CONCRETE CONTROL CHAMBERS MOUNTED ON SEABED OIL STORAGE MODULE," OCEAN INDUSTRY, VOL. 12, NO. 9, PP 195-196, (0 REF).
72. BURTON, R.A., "CONCRETE BOATS AND SHIPS," OFFICE OF NAVAL RESEARCH LONDON (ENGLAND)(265 000), REPT. NO. ONRL-73-68.
73. BURY, M.R.C., AND DOMONE, P.L., "THE ROLE OF RESEARCH IN THE DESIGN OF CONCRETE OFFSHORE STRUCTURES," PROC. OTC, HOUSTON, VOL. I, 1974, (22 REF).
74. BUTLER, P., "AN UNSINKABLE CASE FOR CONCRETE VESSELS," ENGINEER (GB), VOL. 244, NO. 6312, PP 38-41, 17 MARCH 1977.
75. CALLIS, C., KNOX, C., SUTTON, D., AND WILEY, S., "AN ASSESSMENT OF GROUTING MATERIALS, PLACEMENT METHODS, AND MONITORING EQUIPMENT FOR OFFSHORE STRUCTURES," PROC. OTC, VOL. IV, NO. 3671, PP 2755-2764, 1979, (6 REF).
76. CAMPBELL, R., "CLASSIFICATION OF CONCRETE VESSELS", CONCRETE SHIPS AND FLOATING STRUCTURES CONVENTION, BERKELEY, SEPT. 1979.
77. CAMPBELL, R.A., AND CHANG, K.T., "CLASSIFICATION OF CONCRETE SHIPS. HISTORICAL BACKGROUND AND CURRENT PRACTICE," CONCRETE SHIPS AND FLOATING STRUCTURES 77, LONDON, PP 22, (27 REF).
78. CARLSEN, K.G., AND VINDVIK, G., "OFFSHORE CONCRETE GRAVITY STRUCTURES - CONSTRUCTION OF A CONDEEP PLATFORM," OCEAN ENG. INF. CENT., ST. JOHN'S, VOL. 1, PP 139-150, 1978.
79. CASTELLI, V.J., "CORROSION AND BIOFOULING ON THE NON-HEAT-EXCHANGER SURFACES OF AN OCEAN THERMAL ENERGY CONVERSION POWER PLANT. A SURVEY," DAVID W. TAYLOR NSRDC, BETHESDA, MARYLAND, REPT. NO. DTNSRDC-79/054, CONTRACT: RL-76-9599, MAY 1979.
80. CHAMBERLIN, R.S., "UNDERSEA OIL STORAGE TANK," ASCE TRANS., CIVIL ENGINEERING ASCE VOL.40, NO. 8, PP 57-60, AUG 1970, (3 REF).
81. CICHANSKI, W.J., AND MAST, R.F., "DESIGN OF A CONCRETE COLD WATER PIPE FOR OCEAN THERMAL ENERGY CONVERSION (OTEC) SYSTEMS," PROC. OTC, VOL. III, NO 3544, PP 1653-1660, 1979, (6 REF).
82. "CLASSIFICATION AND SURVEY OF CONCRETE SHIPS AND PONTOONS", BUREAU VERITAS, GUIDANCE NOTE NI 175 CN4, 1979.

SUBJECT: REINFORCED CONCRETE APPLICABLE TO FLOATING MARINE STRUCTURES

83. CLAUSEN, C.J.F., DIBIAGIO, ELMO, DUNCAN, J.M., AND ANDERSEN, K.H., "OBSERVED BEHAVIOR OF THE EKOFISK OIL STORAGE TANK FOUNDATION," PROC. OTC, VOL. III, PP 399-413, 1975, (7 REF).
84. CLEARY, H.J., "ON THE MECHANISM OF CORROSION OF STEEL IMMERSSED IN SALINE WATER," PROC. OTC, VOL. I, 1969, (48 REF).
85. CLOSNER, J.J., CONVINI, R.H., AND MARCHAJ, T.J., "PURGING, COOL-DOWN, PERFORMANCE TESTING OF PRESTRESSED CONCRETE LNG CONTAINERS," AMERICAN GAS ASSOC. OPER. SECT. PROC. 1976, PAPER 76-T-33, P 9.
86. CLOSNER, J.J., DE BOCK, L.F., LEGATOS, N.A., MARCHAJ, T.J., AND GERWICK, B.C., "PRESTRESSED CONCRETE FOR THE TRANSPORT OF LIQUEFIED NATURAL GAS," ASME PAPER NO. 73-PET-37 FOR MEET. SEPTEMBER 16-20, 1973.
87. CLOSNER, J.J., DE BOCK, L.F., LEGATOS, N.A., MARCHAJ, T.J., AND GERWICK, B.C. JR., "PRESTRESSED CONCRETE PROPOSED FOR LNG CARRIERS," OCEAN INDUSTRY, VOL. 19, NO. 2, P 6.
88. CLOSNER, J.J., MARCHAJ, T., "PRESTRESSED CONCRETE FOR PRIMARY STORAGE OF LNG OR LPG ON SHIPS OR BARGES AND AS A SECONDARY BARRIER", CONCRETE SHIPS AND FLOATING STRUCTURES CONVENTION, BERKELEY, SEPT. 1975.
89. COBBETT, J.S., "DRILLING FROM DEEPWATER, CONCRETE GRAVITY PLATFORMS," JPT. J. PET. TECHNOL., VOL. 31, NO. 7, PP 926-932, JULY 1979.
90. "CONCRETE ARTICULATED PRODUCTION TOWER." OCEAN INDUSTRY, VOL. 12, NO. 3, P 54, 1977, (0 REF).
91. "CONCRETE BARGE HOUSES GRAVITY OIL/WATER SEPERATOR," OCEAN INDUSTRY, VOL. 11, NO. 5, P 38, 1976, (0 REF).
92. "CONCRETE CARGO SUBMARINES ?" OCEAN INDUSTRY, VOL. 6, NO. 11, P 27, 1971, (0 REF).
93. "CONCRETE GOES TO SEA," OCEAN INDUSTRY, VOL. 9, NO. 2, PP 33-34, 1974, (0 REF).
94. "CONCRETE GRAVITY STRUCTURES FOR THE NORTH SEA," OCEAN INDUSTRY, VOL. 9, NO. 3, PP 54-58, 1974, (0 REF).
95. "CONCRETE LNG TANKER IS A NEW CONCEPT," CONCRETE PUBLICATION NO. 11, VOL. 10, PP 22-23, NOVEMBER 1976, (0 REF).
96. "CONCRETE LNG VESSEL HALVES COSTS OF ONSHORE FACILITY," TRANSPORT DEVELOPMENT NEWS, P 29, 1976.



SUBJECT: REINFORCED CONCRETE APPLICABLE TO FLOATING MARINE STRUCTURES

97. "CONCRETE PRODUCTION PLATFORM WILL HAVE 1-MILLION-BARREL STORAGE CAPACITY," OCEAN INDUSTRY, VOL. 10, NO. 8, PP 56-58, 1975, (0 REF).
98. "CONCRETE SEMI-SUBMERSIBLE," OCEAN INDUSTRY, VOL. 9, NO. 10, PP 103-108, (0 REF).
99. "CONCRETE SHIPS FOR HAULING LNG?" OCEAN INDUSTRY, VOL. 12, NO. 5, PP 67-74, 1977, (0 REF).
100. "CONDRILL- CONCRETE SEMI-SUBMERSIBLE FOR SEVERE SEAS," OCEAN INDUSTRY, VOL. 10, NO. 2, PP 200-201, 1975, (0 REF).
101. "CONDRILL II DESIGNED WITH SHALLOW DRAFT," OCEAN INDUSTRY, VOL. 10, NO. 5, P 56, 1975, (0 REF).
102. CONJEAUD, M.L., "MECHANISM OF SEA WATER ATTACK ON CEMENT MORTAR", PERFORMANCE OF CONCRETE IN MARINE ENVIRONMENT, ACI SPECIAL PUBLICATION SP-65, 1980.
103. "CONSTRUCTION GOING SMOOTHLY ON NINIAN CONCRETE PLATFORM," OCEAN INDUSTRY, VOL. 11, NO. 5, PP 82-88, 1976, (0 REF).
104. "CONVERTING A BOOSTER PLATFORM TO A PRODUCTION PLATFORM," OCEAN INDUSTRY, VOL. 11, NO 5, PP 74-78, 1976, (0 REF).
105. COOK, A., "ZINC AND THE PROTECTION OF OFFSHORE STRUCTURES," PROC. OTC, VOL. I, 1969 (12 REF).
106. CORK, H.A., "COATING TREATMENT FOR REINFORCING STEEL." CONCRETE PUBLICATION NO. 1, VOL. 11, PP 31-33, JAN 1977, (2 REF).
107. CORLEY, W.G., HANSON, J.M., HELGASON, T., "DESIGN OF REINFORCED CONCRETE FOR FATIGUE", JOURNAL OF THE STRUCTURAL DIVISION ASCE, VOL. 104, NO. ST6, PP 921-932, JUNE 1978, (8 REF).
108. CORNET, I., PIRTZ, D., POLIVKA, M., GAU, Y., AND SHIMIZU, A., "EFFECT OF STRAY ELECTRIC CURRENT ON THE CORROSION OF PRE-STRESSED CONCRETE IN SEA WATER," PROC. OTC, VOL. 11, NO. 3195, PP 1251-1256, 1978 (13 REF).
109. COVEYDU, T.T., "THE 1973 UNIVERSITY OF MICHIGAN FERRO-CEMENT CANDE PROJECT," MARINE TECHNOLOGY, VOL. 11, NO 2, PP 215-223, APRIL 1974, (1 REF).
110. CRANDALL, P.S., "LARGE FLOATING DRY DOCKS FOR LARGE SHIPS," MARINE TECHNOLOGY, VOL. 13, NO. 2, PP 184-191, APRIL 1976, (0 REF).
111. CUMMINGS, G., "LEARNING CURVE FOR CONCRETE PLATFORMS NOT YET COMPLETED," OCEAN INDUSTRY, VOL. 13, NO. 3, PP 58-60, 1978, (0 REF).

[Handwritten signature]

SUBJECT: REINFORCED CONCRETE APPLICABLE TO FLOATING MARINE STRUCTURES

112. CURRY, R., "CONCRETE AS A SHIP AND BOATBUILDING MATERIAL", SYMPOSIUM ON INDIAN SHIPBUILDING, CALCUTTA, INDIA, FEB 1980, (104 REF).
113. DEAN, R.G., MORAN, G., MANLEY, R.N., SCHMELTZ, E.J., OMOHUNDRO, F., "MODEL STUDIES TO EVALUATE AN OFFSHORE NUCLEAR POWER PLANT DESIGN," PROC. OTC, HOUSTON, VOL. I, 1974, (2 REF).
114. DERRINGTON, J.A., "FLOATING CONCRETE STRUCTURES FOR ENERGY PRODUCTION", CONCRETE SHIPS AND FLOATING STRUCTURES CONVENTION, ROTTERDAM, NOV. 1979.
115. DE PVY, G.W., AND DIKEOU, J.T., "DEVELOPMENT OF POLYMER-IMPREGNATED CONCRETE AS A CONSTRUCTION MATERIAL FOR ENGINEERING PROJECTS," ACI PUBLICATION (SP-40), DETROIT, MICHIGAN, 1973.
116. DERRINGTON, J.A., "MARINE STRUCTURES FOR ENERGY CONVERSION," IEE CONF. PUBL., NO. 171, 1979.
117. DE WINTON, C., "COMPLETION NEAR FOR NINIAN CONTROL PLATFORM," GAS WORLD GAS JOURNAL, VOL. 182, NO. 4699, P. 104, 106, 113, 115, FEBRUARY 1977.
118. DINSENBACHER, A.L., AND BRAUER, F.E., "MATERIAL DEVELOPMENT, DESIGN, CONSTRUCTION, AND EVALUATION OF A FERRO-CEMENT PLANING BOAT," MARINE TECHNOLOGY, VOL. 11, NO 3, PP 277-296, JULY 1974, (5 REF).
119. DOUGHTY, S.C., "DEEP SEA CONSTRUCTION", JOURNAL OF THE CONSTRUCTION DIVISION ASCE, VOL. 101, PP 607-622, SEPT 1975, (2 REF).
120. "DRAFT FOR DEVELOPMENT, FIXED OFFSHORE STRUCTURES", BRITISH STANDARD INSTITUTE, DD 65, 1978.
121. DRISKO, R.W., "EFFECTS OF ENERGY, ECONOMICS, AND ECOLOGY ON MARINE COATINGS," CORROS 76, HOUSTON, TEXAS, PAPER 62, PUBL. BY NACE, MARCH 22-26, 1976.
122. DUGGER, G.L., "WORKSHOP ON OCEAN THERMAL ENERGY CONVERSION (OTEC), 3RD, PROCEEDINGS, 1975.
123. DURABILITY OF CONCRETE, ACI SPECIAL PUBLICATION, SP-47, DETROIT, MICHIGAN, 1975.
124. EDDIE, A.G.F., "CONCRETE REPLACES STEEL IN OFFSHORE COAL-LOADING TERMINAL," ASCE CIVIL ENGINEERING, VOL. 46, NO. 4, PP 60-62.
125. EDDIE, A.G.F., "LESSONS LEARNED FROM TWO MAJOR FLOATING CONCRETE STRUCTURES PROJECTS IN AUSTRALIA", CONCRETE SHIPS AND FLOATING STRUCTURES CONVENTION, ROTTERDAM, NOV. 1979.

229

SUBJECT: REINFORCED CONCRETE APPLICABLE TO FLOATING MARINE STRUCTURES

126. EDDIE, A.G.F., SHIN, D.S., SANDERS, T.G., HAWRYCH, J.R., "PROPOSAL FOR THE CONSTRUCTION OF PRE-STRESSED CONCRETE SUPER-BARGES FOR PROCESS PLANTS", CONCRETE SHIPS AND FLOATING STRUCTURES CONVENTION, ROTTERDAM, NOV. 1979.
127. EDDY, C.A., "ATLANTIC REGION CEMENTS: PAST, PRESENT, AND FUTURE", PERFORMANCE OF CONCRETE IN MARINE ENVIRONMENT, ACI SPECIAL PUBLICATION SP-65, 1980.
128. EIDE, O.T., AND LARSEN, L.G., "INSTALLATION OF THE SHELL/ESSO BRENT 3 CONDEEP PRODUCTION PLATFORM," PROC. OTC, VOL. I, PP 101-114, 1976, (8 REF).
129. "EKOFISK ONE BECOMES AN ISLAND IN THE NORTH SEA," OCEAN INDUSTRY, VOL. 8, NO. 8, PP 21-24, 1973, (0 REF).
130. FRI, J., BALL, D., AND MIDDLETON, E.M., "APPLICATION OF REGULATIONS AND DESIGN CODES FOR OFFSHORE INSTALLATIONS," PROC. OTC, VOL. II, PP 431-440, 1977, (20 REF).
131. ERTNER, J.D., "POST-TENSIONED REINFORCED CONCRETE AS APPLIED TO SHIP DESIGN AND CONSTRUCTION," NAVAL ENG. JOURNAL, VOL. 89, NO. 2, PP 171-181, APRIL 1977, (18 REF).
132. EVANS, W., "AN APPRAISAL OF STEEL REINFORCEMENT AND PRESTRESSING TENDONS," CONCRETE PUBL. NO. 4, VOL. 12, PP 28-30, APRIL 1978, (3 REF).
133. EVANS, J.H., AND BOUFGUNDS, TH.P., "THE RESISTANCE OF A REINFORCED CONCRETE CYLINDRICAL STEEL TO PENETRATION BY A KNIFE EDGE LOAD," ISP, VOL. 24, NO. 271, PP 55-59, MARCH 1977, (4 REF).
134. "FERROCEMENT BOATS," CONCRETE PUBLICATION NO. 9, VOL. 7, PP 30-32, SEPT. 1973, (0 REF).
135. FIDJESTOL, P., NILSEN, N., "FIELD TEST OF REINFORCEMENT CORROSION IN CONCRETE", PERFORMANCE OF CONCRETE IN MARINE ENVIRONMENT, ACI SPECIAL PUBLICATION SP-65, 1980.
136. FINSTERWALDER, K., "FLOATING REINFORCED AND PRESTRESSED CONCRETE STRUCTURES FOR PRODUCTION AND STORAGE OF LIQUEFIED NATURAL GAS (LNG)", CONCRETE SHIPS AND FLOATING STRUCTURES CONVENTION, ROTTERDAM, NOV. 1979.
137. FJEILD, S., "CODE CALIBRATION", DET NORSKE VERITAS, NORWAY, (27 REF).
138. FJEILD, S., "CONCRETE STRUCTURES", DET NORSKE VERITAS, NORWAY, (0 REF).

SUBJECT: REINFORCED CONCRETE APPLICABLE TO FLOATING MARINE STRUCTURES

139. FJELD, S., "CURRENT CODE PRACTICE", DET NORSKE VERITAS, NORWAY, (0 REF).
140. FJELD, S., "IN SERVICE PERFORMANCE", DET NORSKE VERITAS, NORWAY (0 REF).
141. FJELD, S., BRAATHEN, N.F., AND HANSVOLD, C., "INSTALLATION OF OFFSHORE PLATFORMS, REFLECTIONS FROM A CERTIFICATION VIEW-POINT," PROC. OTC, VOL. II, NO. 2862, PP 441-448, 1977, (4 REF).
142. FJELD, S., FURNES, O., HANSVOLD, C., ROLAND, B., BLAKER, B., AND MORLEY, C., "SPECIAL PROBLEMS IN STRUCTURAL ANALYSIS AND DESIGN OF OFFSHORE CONCRETE PLATFORMS," PROC. OTC, VOL. I NO. 3087, PP 335-344, 1978, (11 REF).
143. "FLOATING CONCRETE PRODUCTION PLATFORM," OCEAN INDUSTRY, VOL. 10, NO. 5, P 56, 1975, (0 REF).
144. "FLOATING CONCRETE STORAGE FACILITY," PROC. ACI, VOL. 72, P 244, MAY 1975.
145. "FLOATING OCEAN PLATFORMS," OCEAN INDUSTRY, VOL. 6, NO. 11, P 24, 1971, (0 REF).
146. FOSTER, J., "NEW SHIPBUILDING DOCK AT THE SPARROWS POINT YARD," MARINE TECHNOLOGY, VOL. 10, NO. 1, PP 1-7, JANUARY 1973, (0 REF).
147. FRANCO, A., "OFFSHORE BRAZIL DUE CONCRETE PLATFORMS," OIL AND GAS JOURNAL, VOL. 74, NO. 18.
148. FRAZIER, K.S., "THE PROTECTION OF REINFORCING STEEL IN CONCRETE," PROC. OTC, HOUSTON, VOL. II, 1970, (14 REF).
149. FURNES, O., "INSTABILITY OF PLANE AND CURVED CONCRETE WALLS IN THE DESIGN OF GRAVITY OFFSHORE PLATFORMS," EUROP. OFFSHORE PET. CONFERENCE AND EXHIBIT PROC., VOL. 1, PP 215-224, 1978.
150. FURNES, O., "GUIDELINES FOR THE DESIGN, CONSTRUCTION AND MAINTENANCE OF CONCRETE SHIPS AND FLOATING STRUCTURES", DET NORSKE VERITAS, (39 REF).
151. FURNES, O., "MODEL TESTS OF CONCRETE CAPPED CYLINDERS", SEMINAR ON THE USE OF PHYSICAL MODELS IN THE DESIGN OF OFFSHORE STRUCTURES, GARSTON, WATFORD, ENGLAND, NOV. 1979, (6 REF).
152. FURNES, O., LOSET, O., "SHELL STRUCTURES IN OFFSHORE PLATFORMS; APPLICATIONS AND DESIGN", IAASS 20TH ANNIVERSY WORLD CONGRESS, MADRID, SEPT 1979, (27 REF).

(231)

SUBJECT: REINFORCED CONCRETE APPLICABLE TO FLOATING MARINE STRUCTURES

153. FURNES, O., SELE, A. "NOTIONAL RELIABILITY IN SHEAR LOAD BASED ON AN ANALYTICAL MODEL REPORTED BY NIELSON, BRAASTRUP, JENSON, AND BACH", IABSE-CEB SYMPOSIUM ON PLASTICITY IN REINFORCED CONCRETE, COPENHAGEN, MAY 1979 (4 REF).
154. FURNES, O., SORENSON, K., "THE USE OF REINFORCED AND PRESTRESSED CONCRETE IN OFFSHORE STRUCTURES", PAPER NO. 1418, PP 13-25, DEC. 1978, (10 REF).
155. FURNES, O., "GUIDELINES FOR THE DESIGN, CONSTRUCTION AND MAINTENANCE OF CONCRETE SHIPS AND FLOATING STRUCTURES", CONCRETE SHIPS AND FLOATING STRUCTURES CONVENTION, ROTTERDAM, NOV. 1979.
156. GAUSEL, E., AND HAFSKJOLD, P.S., "CONCRETE OFFSHORE STRUCTURES - BEHAVIOR OF FULL SCALE SHELLS, HYDROSTATICALLY LOADED," PROC. OTC, VOL. IV, NO. 3007, PP 323-328, 1977, (1 REF).
157. GAUSEL, E., FLUGE, F., AND HAFSKJOLD, P.S., "CONCRETE OFFSHORE STRUCTURES, STRAINS MEASURED ON FULL SCALE SHELLS," PROC. OTC, VOL. I, PP 119-129, 1976, (3 REF).
158. GAUSEL, E., FLUGE, F., AND HAFSKJOLD, P.S., "CONCRETE OFFSHORE STRUCTURES-STRUCTURAL ASPECTS," PROC. OTC, VOL. III, PP 689-694, 1975, (1 REF).
159. GEORGE, C.M., "LONG TERM AND ACCELERATED TESTS OF THE RESISTANCE OF CEMENTS TO SEA WATER, WITH SPECIAl REFERENCE TO ALUMINOUS CEMENTS", PERFORMANCE OF CONCRETE IN MARINE ENVIRONMENT, ACI SPECIAL PUBLICATION SP-65, 1980.
160. GEORGE, P.J., AND SHAW, P.G.H., "CERTIFICATION OF CONCRETE GRAVITY PLATFORMS IN THE NORTH SEA," PROC. OTC, VOL. I, PP 131-148, 1976, (13 REF).
161. GERWICK, B.C., "A FUTURE FOR CONCRETE OFFSHORE STRUCTURES?" CONCRETE PUBLICATION NO. 1, VOL. 11, PP 21-23, JAN. 1977, (0 REF).
162. GERWICK, B.C., "APPLICATION OF CONCRETE DRILLING AND PRODUCTION CAISSONS TO SEISMIC AREAS," PROC. OTC, VOL. III, PP 721-730, 1975, (12 REF).
163. GERWICK, B.C., "CONCRETE OIL STORAGE TANK TO REST IN NORTH SEA," CIVIL ENGINEERING, ASCE, VOL. 43, NO. 8, PP 81-85, AUG. 1973.
164. GERWICK, B.C., "CONCRETE STRUCTURES FOR 2000M DEPTH," PUBL. BY IEEE (75 CHD 995-1 DEC), NEW YORK, NEW YORK, 1975.
165. GERWICK, B.C. JR., "CONCRETE STRUCTURES, KEY TO DEVELOPMENT OF THE OCEANS," PROC. ACI, VOL. 71, PP 611-616, DECEMBER 1974, (8 REF).

232

SUBJECT: REINFORCED CONCRETE APPLICABLE TO FLOATING MARINE STRUCTURES

166. GERWICK, B.C., "CONDEEP IN 400 FT OF WATER, CONCRETE CAISSON REQUIRES NO PILES," ASCI, VOL. 46, NO. 4.
167. GERWICK, B.C. JR., "CONSTRUCTION OF LARGE CONCRETE OCEAN STRUCTURES," ASCE JOURNAL, CONSTR. DIV., VOL. 97, NO. CO1, PAPER 7991, PP 1-16, MARCH 1971.
168. GERWICK, B.C., "CURRENT TRENDS IN DESIGN AND CONSTRUCTION OF CONCRETE SHIPS," CONCRETE SHIPS AND FLOATING STRUCTURES 77, LONDON, PP 9, (3 REF).
169. GERWICK, B.C., "DESIGN CONCEPTS FOR EFFICIENT USE OF PRESTRESSED CONCRETE SHIP HULLS " SNAME SPRING MEETING AND STAR SYMPOSIUM SAN FRANCISCO, 1977, PP 465-474, (5 REF).
170. GERWICK, B.C., JR., "FLOATING CONCRETE TERMINAL FOR ARCTIC SEAS," OCEAN INDUSTRY, VOL. 10, NO. 11, 1975, (3 REF).
171. GERWICK, B.C., JR., "MATERIALS FOR CONCRETE SHIPS: DURABILITY AND CORROSION PROTECTION, COATINGS, INSPECTION AND REPAIR", PROCEEDINGS - CONCRETE SHIPS AND FLOATING STRUCTURES, BERKELEY CALIFORNIA, 1975.
172. GERWICK, B.C., JR., "OCEAN STRUCTURES OF PRESTRESSED CONCRETE," PRESTRESSED CONCRETE INSTITUTE JOURNAL, VOL. 16, NO. 2, PP 10-23, (17 REF).
173. GERWICK, B.C., "PRACTICAL METHODS OF ENSURING DURABILITY OF PRESTRESSED CONCRETE OCEAN STRUCTURES," DURABILITY OF CONCRETE, PP 317-324, PUBLISHED BY ACI (SP-47), DETROIT, MICHIGAN, 1975, (5 REF).
174. GERWICK, B.C., "PREPARATION OF FOUNDATIONS FOR CONCRETE CAISSON SEA STRUCTURES," PROC. OTC, HOUSTON, VOL. I, 1974, (7 REF).
175. GERWICK, B.C. JR., "PRESTRESSED CONCRETE OCEAN STRUCTURES," BUILD. INT., VOL. 4, NO. 3, PP 167-76, MAY-JUNE 1971.
176. GERWICK, B.C., JR., "PRESTRESSED CONCRETE OCEAN STRUCTURES AND SHIPS", PCI, CHICAGO, ILLINOIS, (63 REF).
177. GERWICK, B.C., "PRESTRESSED CONCRETE UNDERWATER OIL STORAGE SYSTEM", " PROC. OTC, VOL. I, 1969, (4 REF).
178. GERWICK, B.C., JR, "SPECIAL PROVISIONS APPLICABLE TO CONCRETE STRUCTURES", ACI PUBLICATION SP-59, CONCRETE DESIGN: U.S. AND EUROPEAN PRACTICES, 1979.
179. GERWICK, B.C., "TECHNIQUES FOR INCREASING THE CAPACITIES OF PIN PILES IN NEW AND EXISTING OFFSHORE CONSTRUCTION," PROC. OTC, HOUSTON, VOL. II, 1971, (0 REF).

SUBJECT: REINFORCED CONCRETE APPLICABLE TO FLOATING MARINE STRUCTURES

180. GERWICK, B.C., AND HOGNESTAD, E., "CONCRETE OIL STORAGE TANK PLACED ON NORTH SEA FLOOR," CIVIL ENG., NEW YORK, VOL. 43, NO. 8, PP 81-85, AUGUST 1973, (0 REF).
181. GERWICK, B.C., JR., JAHNS, H.D., "CONCEPTUAL DESIGN OF FLOATING DRILLING PRODUCTION AND STORAGE CAISSON FOR ARCTIC WATERS", PORT AND OCEAN ENGINEERING INSTITUTE OF TECHNOLOGY, 1979, (7 REF).
182. GERWICK, B.C., AND LLOYD, R.R., "DESIGN AND CONSTRUCTION PROCEDURES FOR PROPOSED ARCTIC OFFSHORE STRUCTURES," PROC. OTC, VOL. II, 1970, (0 REF).
183. GERWICK, B.C., AND VENUTI, W.J., "HIGH-AND-LOW-CYCLE FATIGUE BEHAVIOR OF PRESTRESSED CONCRETE IN OFFSHORE STRUCTURES," PROC. OTC, VOL. I, NO. 3381, PP 207-214, 1979, (34 REF).
184. GERWICK, B.C. JR., MANSOUR, A.E., PRICE, E., AND THAYAMBALLI, A., "FEASIBILITY AND COMPARATIVE STUDIES FOR THE USE OF PRESTRESSED CONCRETE IN LARGE STORAGE/PROCESSING VESSELS," SNAME ANNUAL MEETING, NEW YORK, NEW YORK, NOVEMBER 16-18, 1978, (15 REF).
185. GERWICK, B.C. JR. "RESEARCH REQUIREMENTS FOR CONCRETE IN MARINE ENVIRONMENTS", PERFORMANCE OF CONCRETE IN MARINE ENVIRONMENT, ACI SPECIAL PUBLICATION SP-65, 1980.
186. GERWICK, B.C. JR., "STATE OF THE ART REPORT: DURABILITY OF CONCRETE STRUCTURES UNDER WATER", CONCRETE SHIPS AND FLOATING STRUCTURES CONVENTION, BERKELEY, SEPT. 1975.
187. GERWICK, B.C. JR., "CONSTRUCTION CONSIDERATIONS II: ASSEMBLY AND LAUNCHING OF CONCRETE SHIPS", CONCRETE SHIPS AND FLOATING STRUCTURES CONVENTION, BERKELEY, SEPT. 1975.
188. GERWICK, B.C. JR., "PROPOSED PRESTRESSED CONCRETE FLOATING TERMINAL FOR ARCTIC OCEAN SERVICE", CONCRETE SHIPS AND FLOATING STRUCTURES CONVENTION, BERKELEY, SEPT. 1975.
189. GEYMAYR, G.A., "REPAIR OF CONCRETE IN TROPICAL MARINE ENVIRONMENT", PERFORMANCE OF CONCRETE IN MARINE ENVIRONMENT, ACI SPECIAL PUBLICATION SP-65, 1980.
190. GILL, H.L., "DEVELOPMENTS IN OCEAN FACILITIES ENGINEERING," MARINE TECHNOLOGY, VOL. 13, NO. 3, PP 233-240, JULY 1976, (9 REF).
191. GIUFFRE, A., AND PINTO, P.E., "GENDA'S FLOATING PRESTRESSED CONCRETE DOCK, COMPUTER AIDED DESIGN-ANALYSIS OF CREEP AND SHRINKAGE EFFECTS", SOGENE, ROME, ITALY, (0 REF).

SUBJECT: REINFORCED CONCRETE APPLICABLE TO FLOATING MARINE STRUCTURES

192. GIVENS, J.J. JR., AND CARTER, G., "REHABILITATION OF OFFSHORE PLATFORMS," CIVIL ENG., VOL. 40, NO. 4, PP 47-49, APRIL 1970.
193. GJERDE, T., "HIGH STRENGTH PRESTRESSED CONCRETE FOR FLOATING STRUCTURES", CONCRETE SHIPS AND FLOATING STRUCTURES CONVENTION, ROTTERDAM, NOV. 1979.
194. GJORV, D.E., "DURABILITY OF MARINE CONCRETE STRUCTURES UNDER ARCTIC CONDITIONS", FIRST INTERNATIONAL CONFERENCE ON PORT AND OCEAN ENGINEERING UNDER ARCTIC CONDITIONS, AUGUST 1971, PROC., VOL. 2, PP 934-943, (6 REF).
195. GJORV, J., "DURABILITY OF REINFORCED CONCRETE WHARVES IN NORWEGIAN HARBOURS," TECHNICAL UNIVERSITY OF NORWAY, TRONDHEIM, MATERIAUX ET CONSTRUCTIONS-MATLS + STRUCTURES, VOL. 2, NO. 12, PP 467-76, NOVEMBER-DECEMBER 1969.
196. GJORV, D.E., "LONG-TIME DURABILITY OF CONCRETE IN SEAWATER," PROC. ACI, VOL. 68, PP 60-67, JANUARY 1971, (1 REF).
197. GJORV, D., "THIN UNDERWATER CONCRETE STRUCTURES," ASCE JOURNAL, CONSTR. DIVISION, VOL. 96, NO. 001, PAPER 7326, PP 9-17, JUNE 1970.
198. GJORV, D.D., VENNESLAND, O., AND EL-BUSAIDY, A.H.S., "ELECTRICAL RESISTIVITY OF CONCRETE IN THE OCEANS," PROC. OTC, VOL. 1, PP 581-588, 1977, (8 REF).
199. GLOCKNER, P.G., GHALI, A., CANDELA, F., DAVENPORT, A.G., FINN, W.D., GERWICK, B.C. JR., NAGHDI, P.M., ODEN, J.T., BUCHERT, K., MCQUIGG, J., BENJAMIN, N., JOHNSON, S., LE DUC, S., GREENWALD, T., KERESZTESY, L.O., FAZIO, P., "SHELL STRUCTURES AND CLIMATIC INFLUENCES," IASS CALGARY SYMPOSIUM PROC., UNIVERSITY OF CALGARY, ALTA., JULY 3-6, 1972.
200. GOLDOVCHENKO, A., AND PRIMUST, I., "REPAIR OF HULLS OF REINFORCED CONCRETE FLOATING DOCKS IN THE NORTH REMONT KORPUSOV ZHELEZO-BETONNYKH PLAVUCHIKH DOKOV NA SEVERE," LIBRARY OF CONGRESS, NO. 1, PP 27-28, ARCTIC INSTITUTE OF NORTH AMERICA,
201. GOPALARATNAM, PAMA, R.P., AND VALLS, J., "A REVIEW OF MARINE APPLICATIONS OF FERROCEMENT IN ASIA," JOURNAL OF FERROCEMENT, VOL. 10, NO. 1, 1980, (15 REF).
202. GOTU, Y., AND MIURA, T., "MECHANICAL PROPERTIES OF CONCRETE AT VERY LOW TEMPERATURES," PROC. JPN. CONGR. MATER. RES. 21ST TOKYO, OCTOBER 1977.

SUBJECT: REINFORCED CONCRETE APPLICABLE TO FLOATING MARINE STRUCTURES

203. GOUDA, V.K., MIKHAIL, R.SH., AND SHATER, M.A., "HARDENED PORTLAND BLAST FURNACE SLAG CEMENT PASTES III CORROSION OF STEEL REINFORCEMENT VERSUS PORE STRUCTURE OF THE PASTE MATRIX," CEMENT AND CONCRETE RESEARCH, VOL. 5, PP 99-102, PERGAMON PRESS, INC., 1975, (7 REF).
204. GOUDA, V.K., SHATER, M.A., AND MIKHAIL, R.SH., "HARDENED PORTLAND BLAST-FURNACE SLAG CEMENT PASTES II THE CORROSION BEHAVIOR OF STEEL REINFORCEMENT," CEMENT AND CONCRETE RESEARCH, VOL. 5, PP 1-13, PERGAMON PRESS, INC., 1975, (15 REF).
205. GRANT, A.B., "UNDERWATER BUOYANT BRIDGES," CONCRETE PUBLICATION NO. 7, VOL. 6, PP 36-37, JULY 1972, (0 REF).
206. "GRAYTHORP'S FLOATING GATE," CONCRETE PUBLICATION NO. 8, VOL. 7, PP 26-27, AUG 1973, (0 REF).
207. GRIFFITHS, E., AND HICKMAN, M.J., "MODERN HEAT INSULATING AND DECKING MATERIALS," TRANS. RECIES, VOL. 59, PART 7, PP 207-230, MAY 1943, (0 REF).
208. "GUIDE FOR THE DESIGN AND CONSTRUCTION OF FIXED OFFSHORE CONCRETE STRUCTURES," REPORTED BY ACI COMMITTEE 357, ACI JOURNAL, V. 75, NO. 12, DECEMBER 1978.
209. "GUIDELINES FOR THE DESIGN, CONSTRUCTION AND CLASSIFICATION OF FLOATING CONCRETE STRUCTURES", DET NORSKE VERITAS, MARCH 1979, (0 REF).
210. HADLEY, H.M., "CONCRETE IN SEA WATER, A REVISED VIEWPOINT NEEDED," ASCE TRANS., VOL. 107, PP 345-394, 1942, (0 REF).
211. HANCOCK, M.V., WHITE, E.I., AND HAY, M.C., "DESIGN, FABRICATION AND INSTALLATION OF THE MINIAN FIELD SOUTHERN PLATFORM," PROC. OTC, VOL. II, NO. 3148, PP 839-850, 1978, (5 REF).
212. HANSEN, H.R., NAAGAARD, K., "SOME RECOMMENDATION FOR DESIGN LOADS AND DESIGN CRITERIA FOR CONCRETE VESSELS", CONCRETE SHIPS AND FLOATING STRUCTURES CONVENTION, BERKELEY, SEPT. 1975.
213. HARDY, F. RAYNAND, J. "CONCRETE SHIPS VERSUS STEEL SHIP: IS THE HEAVIER HULL FEASIBLE?", CONCRETE SHIPS AN FLOATING STRUCTURES CONVENTION, ROTTERDAM, NOV 1979.
214. HARRIS, A., "OPTIMISATION OF CONCRETE HULLS", CONCRETE SHIPS AND FLOATING STRUCTURES CONVENTION, BERKELEY, SEPT. 1975.
215. HARRIS, A., "CHARACTERISTICS, FACTORS AND DESIGN CRITERIA", CONCRETE SHIPS AND FLOATING STRUCTURES CONVENTION, BERKELEY, SEPT. 1975.
216. HARRIS, B., VARLOW, J., AND ELLIS, C.O., "THE FRACTURE BEHAVIOR OF REINFORCED CONCRETE," CEMENT AND CONCRETE RESEARCH, VOL. 2, PP 447-461, 1972, PERGAMON PRESS, INC., (7 REF).

SUBJECT: REINFORCED CONCRETE APPLICABLE TO FLOATING MARINE STRUCTURES

217. HARTT, W.H., ROSENBERG, A.M. "INFLUENCE OF CHLORIDES ON SEA WATER CORROSION OF REINFORCING STEEL IN CONCRETE", PERFORMANCE OF CONCRETE IN MARINE ENVIRONMENT, ACI SPECIAL PUBLICATION SP-65, 1980.
218. HAWKINS, N.M., "FATIGUE CONSIDERATIONS FOR CONCRETE SHIPS AND OFFSHORE STRUCTURES", CONCRETE SHIPS AND FLOATING STRUCTURES CONVENTION, BERKELEY, SEPT. 1975.
219. HAWKINS, N.M., "SHEAR CONSIDERATIONS FOR CONCRETE SHIPS AND OFFSHORE STRUCTURES", CONCRETE SHIPS AND FLOATING STRUCTURES CONVENTION, BERKELEY, SEPT. 1975.
220. HAY, N.E., AND JANSKY, C., "THE MARKET FOR CONCRETE GAS CARRIERS, CONFERENCE OF CONCRETE SOCIETY AND RINA PROC., 7 PP, LONDON, 1977, (6 REF).
221. HAYNES, H.H., "DESIGN FOR IMPLOSION OF CONCRETE CYLINDER STRUCTURES UNDER HYDROSTATIC LOADING", CIVIL ENGINEERING LABORATORY TECH REPORT R-874, AUGUST 1979, (26 REF).
222. HAYNES, H.H., AND ECKROTH, W.V., "LIGHTWEIGHT CONCRETE USING POLYMER-FILLED AGGREGATE FOR OCEAN APPLICATIONS, AN EXPLORATORY INVESTIGATION", CIVIL ENGINEERING LABORATORY TECH NOTE N-1565, DECEMBER 1979, (0 REF).
223. HAYNES, H.H., AND HIGHBERG, R.S., "CONCRETE PROPERTIES AT OCEAN DEPTHS," JOURNAL OF THE WATERS, HARBOR AND COASTAL ENGINEERING DIVISION, ASCE, VOL. 102, NO. 4, PP 455-470, NOVEMBER 1976.
224. HAYNES, H.H., AND HIGHBERG, R.S., "LONG-TERM, DEEP-OCEAN TEST OF CONCRETE SPHERICAL STRUCTURES - RESULTS AFTER 6 YEARS", CIVIL ENGINEERING LABORATORY TECH REPORT R-869, JAN. 1979, (13 REF).
225. HAYNES, H.H., AND FAIL, R.D., "CONCRETE FOR OCEAN THERMAL ENERGY CONVERSION STRUCTURES," NTIS REPT. NO. CEL-TN-1448.
226. HAYNES, H.H., AND ZUBIATE, P.C.J., "COMPREHENSIVE STRENGTH OF 67-YEAR OLD CONCRETE SUBMERGED IN SEAWATER," NTIS REPT. NO. NCEL-TN-1308.
227. HAYNES, H.H., KAHN, L.F., AND STACHIW, J.D., "CONCRETE HULLS FOR UNDERSEA APPLICATIONS," JOURNAL OF STRUCTURAL DIVISION, ASCE, VOL. 97, NO. ST4, PP 1283-1303, APRIL 1971, (0 REF).
228. HAYNES, H.H., "PERMEABILITY OF CONCRETE IN SEA WATER", PERFORMANCE OF CONCRETE IN MARINE ENVIRONMENT, ACI SPECIAL PUBLICATION SP-65, 1980.

SUBJECT: REINFORCED CONCRETE APPLICABLE TO FLOATING MARINE STRUCTURES

229. HAYNES, H.H., "STRUCTURAL CONSIDERATIONS AND CONFIGURATIONS III", CONCRETE SHIPS AND FLOATING STRUCTURES CONVENTION, BERKELEY, SEPT. 1975.
230. HELGASON, T., HANSON, J.M., SOMES, N.F., CORLEY, W.G., HOGNESTAD, E., "FATIGUE STRENGTH OF HIGH-YIELD REINFORCING BARS", NATIONAL COOPERATIVE HIGHWAY RESEARCH PROGRAM REPORT 164, PART 1, 30 PP, (107 REF).
231. HENECHAN, J.I., "SHORCRETE REPAIRS OF CONCRETE STRUCTURES IN MARINE ENVIRONMENT", PERFORMANCE OF CONCRETE IN MARINE ENVIRONMENT, ACI SPECIAL PUBLICATION SP-65, 1980.
232. HETHERINGTON, W.G., "FLOATING JETTIES - CONSTRUCTION, DAMAGE AND REPAIR", CONCRETE SHIPS AND FLOATING STRUCTURES CONVENTION, ROTTERDAM, NOV. 1979.
233. HIGHBERG, R.S., AND HAYNES, H.H., "OCEAN IMPLOSION TEST OF CONCRETE (SEACON) CYLINDRICAL STRUCTURE," PROC. OTC, VOL. IV, NO. 3011, PP 363-370, 1977, (10 REF).
234. HIGHBERG, R.S., AND HAYNES, H.H., "PREDICTING THE MAXIMUM OCEAN DEPTHS FOR SUBMERGED CONCRETE STRUCTURES," EUR. OFFSHORE PET. CONF. AND EXHIB. PROC., VOL. 1, PP 233-240, 1978.
235. HODSON, J.S., "FERRO CEMENT CONSTRUCTION IN DEVELOPING COUNTRIES", CONCRETE SHIPS AND FLOATING STRUCTURES CONVENTION, ROTTERDAM, NOV. 1979.
236. HULAND, I, "NORWEGIAN REGULATIONS FOR DESIGN OF OFFSHORE STRUCTURES," PROC. OTC, VOL. II, NO. 2663, PP 449-453, 1977, (14 REF).
237. HOLM, T.A., "PERFORMANCE OF STRUCTURAL LIGHTWEIGHT CONCRETE IN MARINE ENVIRONMENT", PERFORMANCE OF CONCRETE IN MARINE ENVIRONMENT, ACI SPECIAL PUBLICATION SP-65, 1980.
238. HORII, O., AND SHIGERU, "STUDY ON FATIGUE BEHAVIOR OF OFFSHORE CONCRETE STRUCTURE," PROC. OTC, VOL. IV, NO. 3005, PP 315-322, 1977, (7 REF).
239. HOLTER, E., AND HAGEN, K., "INTEGRATED AND SEMI-INTEGRATED DECK CONCEPTS FOR PRODUCTION PLATFORMS WITH EMPHASIS ON CAPITAL COST OPTIMIZATION," PROC. OTC, VOL. III, PP 789-805, 1976, (0 REF).
240. HOOPER, R., "A SEMI-SUBMERGED STABLE PLATFORM AS AN OFFSHORE PORT," PROC. OTC, HOUSTON, VOL. I, 1971, (0 REF).
241. HOVE, K., AND FOSS, I., "QUALITY ASSURANCE FOR OFFSHORE CONCRETE GRAVITY STRUCTURES," PROC. OTC, HOUSTON, VOL. II, PP 829-842, 1974, (11 REF).

SUBJECT: REINFORCED CONCRETE APPLICABLE TO FLOATING MARINE STRUCTURES

242. "HOW MANY PLATFORMS WILL BE REQUIRED IN THE NORTH SEA ?" OCEAN INDUSTRY, VOL. 9, NO. 8, PP 51-53, 1974, (0 REF).
243. HUNTEMAN, J.E., ANASTASIO, F.L. JR., AND DESHAZER W.A., "CONCRETE GRAVITY PLATFORM IN SHALLOW OFFSHORE LOUISIANA WATER," PROC. OTC, VOL. II, NO 3473, PP 1003-1008, 1979, (0 REF).
244. "HYBRID GRAVITY PLATFORM COMBINES STEEL TOWER, CONCRETE BASE," OCEAN INDUSTRY, VOL. 11, NO. 5, PP 78-82, 1976, (0 REF).
245. "HYBRID GRAVITY PLATFORM WITH TELESCOPING COLUMN," OCEAN INDUSTRY, VOL. 11, NO. 11, PP 99-100, 1976, (0 REF).
246. INGRAHAM, W.A., "THE HISTORY OF CONCRETE STRUCTURES IN THE GULF OF MEXICO AND THEIR FUTURE", CONCRETE SHIPS AND FLOATATION STRUCTURES CONVENTION, ROTTERDAM, NOV. 1979.
247. "INNOVATIVE CONCRETE GRAVITY PLATFORM," OCEAN INDUSTRY, VOL. 11, NO. 3, 1976, (0 REF).
248. INOMATA, S., "JAPANESE RULE ON PRESTRESSED CONCRETE BARGES," CONCRETE SHIPS AND FLOATING STRUCTURES CONVENTION, BERKKELEY, SEPT. 1975.
249. "INTERNATIONAL OFFSHORE CRAFT CONFERENCE, 2ND, 1976," REED (THOMAS) INDUSTRIAL PRESS LTD., 36/37 COCK LANE, LONDON EC1A 9BY, ENGLAND, 203 PP, 1977.
250. IORNS, M.E., "COST REDUCTION AND QUALITY CONTROL IN FERROCEMENT AND MARINE CONCRETE," JOURNAL OF FERROCEMENT, VOL. 10, NO. 1, PP 11-17, JANUARY 1980, (9 REF).
251. IORNS, M.E., AND WATSON, L.L., "FERROCEMENT BOATS REINFORCED WITH EXPANDED METAL," JOURNAL OF FERROCEMENT, VOL. 7, NO. 1, PP 9-16, JULY 1977, (8 REF).
252. JACKSON, G., "FUTURE WITH A PROMISE FOR CONCRETE BOAT-BUILDING," CONCRETE CONSTRUCTION, VOL. 14, NO. 9, 10, PP 344-6, SEPTEMBER, PP 381-383, OCTOBER 1969.
253. JANSKY, C., MASCARO, F., "OWNER AND OPERATOR REQUIREMENTS AND APPLICATIONS FOR CONCRETE SHIPS", CONCRETE SHIPS AND FLOATING STRUCTURES CONVENTION, BERKELEY, SEPT. 1975.
254. JAZRAWI, W., AND KHANNA, J., "MONOCONE - A MOBILE GRAVITY PLATFORM FOR THE ARTIC OFFSHORE," POAC '77: INT. CONF. ON PORT AND OCEAN ENGR. UNDER ARCTIC CONDITIONS, 4TH, 1977.
255. JENSSEN, D.N., HJERTAS, B., "GRAVITY PLATFORM TOWER VIBRATION," PROC. OTC, VOL. III, PP 209-216, 1977, (9 REF).

SUBJECT: REINFORCED CONCRETE APPLICABLE TO FLOATING MARINE STRUCTURES

256. JIRCA, J.C., WILHOIT, J.C., AGUIRRE, M., AND MOGGO, N.C., "EFFECT OF CONCRETE COATING ON THE RIGIDITY OF 12 3/4-IN. LINE PIPE," PROC. OTC, VOL. II, 1969, (2 REF).
257. JONES, L., AND TURNER, F.H., "BRITAIN'S FIRST CONCRETE SHIP" CONCRETE PUBLICATION NO. 7, VOL. 6, PP 26-27, JULY 1972, (0 REF).
258. JOPLIN, J.F., "DESIGN OF 40,000- HP BARGE MOUNTED HIGH PRESSURE PIPELINE STATION," ASME PAPER 72-GT-107 FOR MEETING MARCH 26-30, 1972.
259. KAAR, P.H., HANSON, N.W., CAPELL, H.T., "STRESS-STRAIN CHARACTERISTICS OF HIGH STRENGTH CONCRETE", INTERNATIONAL SYMPOSIUM ON CONCRETE AND CONCRETE STRUCTURES, ACI, DETROIT, MICHIGAN, (9 REF).
260. KAHN, L.F., AND HAYNES, H.H., "UNDERSEA CONCRETE HABITATS," OCEAN INDUSTRY, VOL. 5, NO. 10, PP 27-29, 1970, (0 REF).
261. KALDJIAN, M.J., AND HUANG, K.N., "GREAT LAKES WINTER NAVIGATION-- TECHNICAL AND ECONOMIC ANALYSIS, VOL. V ICE STRENGTHENING OF SHIP HULLS USING STEEL, FERROCEMENT OR REINFORCED CONCRETE," UNIV. OF MICHIGAN, REPT. NO. 155, 28 PP.
262. KALDJIAN, M.J., TOWNSEND, W.H., KAHN, L.F., AND HUANG, K.N., "GREAT LAKES WINTER NAVIGATION--TECHNICAL AND ECONOMIC ANALYSES VOL. IV STRENGTHENING STEEL PLATES USING FERROCEMENT AND REINFORCED CONCRETE," UNIV. OF MICHIGAN, ANN ARBOR, MARITIME ADMINISTRATION, REPORT NO. 154.
263. KASAI, Y., NAKAMURA, N. "ACCELERATED TEST METHOD FOR DURABILITY OF CEMENT MORTARS IN SEA WATER", PERFORMANCE OF CONCRETE IN MARINE ENVIRONMENT, ACI SPECIAL PUBLICATION SP-65, 1980.
264. KATSUMATA, T., OKA, H., MIKAMI, Y., OGITA, H., AND NISHIMURA, Y., "LOW TEMPERATURE CHARACTERISTICS OF PRESTRESSING STEEL," SUMITOMO ELECTR. TECH. REV. NO. 13, PP 47-56, DECEMBER 1978.
265. KEHNEMUMYI, M., AND LOCHBAUM, R.E., "OFFSHORE NUCLEAR POWER PLANTS," MARINE TECHNOLOGY, VOL. 10, NO. 3, PP 244-253, JULY 1973, (0 REF).
266. KELLY, W.E., DEMARS, AND DEMARS, K.R., "ENGINEERING PROPERTIES OF CEMENTED DEEP-OCEAN SEDIMENTS," PROC. OTC, HOUSTON, VOL. II, PP. 589-594, 1974, (17 REF).
267. KENNEDY, J.L., "CONCRETE. A PROMISING OFFSHORE CONSTRUCTION MATERIAL," OIL GAS JOURNAL, VOL. 68, NO. 48, PP 61- 4, 69, NOVEMBER 1970.

240

SUBJECT: REINFORCED CONCRETE APPLICABLE TO FLOATING MARINE STRUCTURES

268. "KEY COMPONENT IN \$350-MILLION COMPLEX INSTALLED IN NORTH SEA," OCEAN INDUSTRY, VOL. 10, NO. 8, 1975, (0 REF).
269. KNECHT, H.I, STUBBS, S.B., AND ERB, P.R., "FLOATING CAISSON VESSEL SYSTEM FOR OIL PRODUCTION IN DEEP WATER," OTC, VOL. 4, PP 2425-2433, 1979.
270. KOBAYASHI, A., YAMADA, T., AND ASADA, T., "EXPERIMENTAL STUDY OF LNG UNDERGROUND TANKER," ASME PAPER NO. 76-WA/PIID-5, DECEMBER 5, 1976.
271. KODER, N.S., "FERROCEMENT FISHING TRAWLERS," INDIAN CONCRETE JOURNAL, VOL. 45, NO. 8, PP 327-8, AUGUST 1971.
272. KOWALSKI, T.G., "DESIRABLE PROPERTIES OF FINE GRAINED CONCRETE FOR MARINE FERROCEMENT USES," JOURNAL OF FERROCEMENT, VOL. 7, NO. 2, PP 96-98, OCTOBER 1977, (0 REF).
273. KRAFT, L.M. JR., AND LYONS, C.G., "STATE -OF-THE-ART: ULTIMATE AXIAL CAPACITY OF GROUTED PILES " PROC. OTC, HOUSTON, VOL II, 1974, (59 REF).
274. KURE, G., AND HJERTAS, B., "DESIGN OF FLOATING CONCRETE PLATFORM FOR DEEP WATER OIL PRODUCTION," PROC. OTC, VOL. II, PP 97-108, 1977, (13 REF).
275. KURE, G., "CONPROD, A FLOATING CONCRETE OIL PRODUCTION PLATFORM", CONCRETE SHIPS AND FLOATING STRUCTURES CONVENTION, ROTTERDAM, NOV. 1979.
276. LACHANCE, L., "FERRO-SHOTCRETE: A PROMISING MATERIAL," OCEAN INDUSTRY, VOL. 5, NO. 11, PP 60-62, 1970, (5 REF).
277. LACHANCE, L., AND FUGERE, P., "CONSTRUCTION OF SAILING BOAT HULL FROM FERRO-SHOTCRETE, (CONSTRUCTION D'UNE COQUE DE VOILIER EN FERRO-SHOTCRETE), UNIVERSITY LAVAL, QUEBEC, VOL. 56, NO. 252, PP 7-14, MARCH 1970.
278. LACROIX, R., "ERDDEL- ARBEITSINSELN AUS BETON IN DER NORDSEE," BETON UND STAHLBETONBAU, HEFT 12, 1975, (0 REF).
279. "LAMBOT'S BOAT..." CONCRETE PUBLICATION NO. 2, VOL. 11, PP 24-25, FEB 1977, (0 REF).
280. LEACH, D., "FLOATING GIANTS OF THE FJORDS," CONCRETE PUBLICATION NO. 4, VOL. 9, PP 29-30, APRIL 1975, (0 REF).
281. LEBRIS, P., "THREE SAFETY FACTORS INCLUDED IN LNG STORAGE TANK SYSTEM," PIPE LINE IND., VOL. 49, NO. 3, PP 45-46, 48, 50, SEPTEMBER 1978.

SUBJECT: REINFORCED CONCRETE APPLICABLE TO FLOATING MARINE STRUCTURES

282. LEICK, R.D., AND BODE, J.H., "IMPLSION STRENGTH OF CYLINDRICAL CONCRETE SHELLS: A COMPARISON OF THEORETICAL AND EXPERIMENTAL RESULTS," PRGC. DTC, VOL. I, NO. 3085, PP 317-326, 1978, (24 REF).
283. LEONHARDT, F., "TWO NEW FRONTIERS FOR PRESTRESSED CONCRETE DESIGN AND CONSTRUCTION," JPC INSTITUTE, VOL. 19, NO. 5, PP 54-69, SEPT.-OCT. 1974.
284. LEONHARDT, F. "PRESTRESSED CONCRETE SHIPS AND SLIPFORM CONSTRUCTION", CONCRETE SHIPS AND FLOATING STRUCTURES CONVENTION, BERKELEY, SEPT. 1975.
285. LESAGE, J., "BETONS ETANCHES AUX PRODUITS PETROLIERS, (OIL-PROOF) CONCRETE)," INST. FRANCO. DU PET., MATER. TECH., NO. 3-4, PP 119-126, MAR-APR 1977.
286. LESAGE, J., AND MERGIER, N., "CONCRETE BEHAVIOR IN SEAWATER: BIBLIOGRAPHICAL REVIEW, COMPORTEMENT DU BETON A L'EAU DE MER. SYNTHESE BIBLIOGRAPHIQUE," SOCIETE DES EDITIONS TECHNIQ, 1977 PARIS, FRANCE, INSTITUT FRANCAIS DU PETROLE, REVUE VOL. 32, NO. 2-7704-7705-PP-257-271, (58 REF).
287. LEVI, F., "GENOA'S FLOATING PRESTRESSED CONCRETE DOCK," RINA, PRESENTED AT CONCRETE SHIPS AND FLOATING STRUCTURES 1977, 11 PP.
288. LIAW, T.C., "ASPECTS OF STEEL CORROSION AND DAMAGE TO CONCRETE CAUSED BY MARINE ENVIRONMENT," INDIAN. CONCR. J., VOL. 47, NO. 6, PP 221-224, JUNE 1973.
289. LIN, C.Y., "COND DETERIORATION DUE TO CORRISION OF REINFORCING STEEL", PERFORMANCE OF CONCRETE IN MARINE ENVIRONMENT, ACI SPECIAL PUBLICATION SP-65, 1980.
290. LIN, T.Y., CHOW, P.Y., "ECONAMICS AND PROBLEM AREAS OF STRUCTURAL AND CONSTRUCTIONAL OPTIONS FOR LARGE PRESTRESSED CONCRETE SHIPS AND VESSELS", CONCRETE SHIPS AND FLOATING STRUCTURES CONVENTION, BERKELYE, SEPT. 1975.
291. LITTLE, D.H., "TWO MAJOR DEVELOPMENTS AT SHEERNESS DOCKS," CONCRETE PUBLICATION NO. 2, VOL. 8, PP 32-34, FEB 1974, (0 REF).
292. LIU, T.C., AND McDONALD, J.E., "CONCRETE SHIPS AND VESSELS - PAST, PRESENT AND FUTURE," ARMY ENGINEER WATERWAYS EXPERIMENT STATION, VICKSBURG, MISS., (038100), FINAL REPORT, NO. WES-4P-C-77-12, OCTOBER 1977.
293. "LNG TRANSPORT COSTS CUT BY CONCRETE," INSTITUTE OF PETROLEUM, PETROLEUM REVIEW, VOL. 31, NO. 367, PP 15-16.

SUBJECT: REINFORCED CONCRETE APPLICABLE TO FLOATING MARINE STRUCTURES

294. LOW, E., "FOUNDATIONS FOR GRAVITY TYPE OFF-SHORE DRILLING/PRODUCTION PLATFORMS", PROC. OFF-SHORE STRUCTURES", PP 27-36, LONDON, OCT. 1974.
295. LOW, J.D., BURRUS, B.S., AND HILL, E.C., "PRODUCTION PROCESSING PROTOTYPE FOR SUBMERGED OPERATIONAL TEST," PROC. OTC, VOL. II, 1969, (0 REF).
296. LYSE, J., "DURABILITY OF CONCRETE IN SEA WATER," ACI JOURNAL, VOL. 32, NO. 12, PP 1575-1584, JUNE 1961, (2 REF).
297. MACALISTER, G., "FERROCEMENT AND THE DEVELOPMENT OF SMALL BOATS," JOURNAL OF FERROCEMENT, VOL. 10, NO. 1, PP 47-50, 1980, (0 REF).
298. MAC LEAY, F.R., "THIN WALL CONCRETE SHIP CONSTRUCTION," PROC. ACI, VOL. 46, PP 193-204, SEPT. 1949 - JUNE 1950, (0 REF).
299. MAGURA, D.D., AND MAST, R.F., "OCEAN THERMAL ENERGY CONVERSION (OTEC) 10 MWE PRELIMINARY PLANTSHIP DESIGN," OTC, 11TH PROC. PP 2059-2066, 1979, (8 REF).
300. MAHAN, L., "SOME THOUGHTS ON METHODS AND MATERIALS FOR FERROCEMENT BOAT CONSTRUCTION, PART I," JOURNAL OF FERROCEMENT, VOL. 10, NO. 1, PP 51-53, 1980, (0 REF).
301. MAIDL, B., AND SCHILLER, W., "TESTING AND EXPERIENCES OF DIFFERENT SCOUR PROTECTION TECHNOLOGIES IN THE NORTH SEA," PROC. OTC, VOL. II, NO. 3470, PP 981-987, 1979, (0 REF).
302. MAKITA, M., MORI, Y., KATAWAKI, K., "PERFORMANCE OF TYPICAL PROTECTION METHODS FOR REINFORCED CONCRETE IN MARINE ENVIRONMENT", PERFORMANCE OF CONCRETE IN MARINE ENVIRONMENT, ACI SPECIAL PUBLICATION SP-65, 1980.
303. MAKITA, Y., MORI, Y., KATAWAKI, K., "MARINE CORROSION BEHAVIOR OF REINFORCED CONCRETE EXPOSED AT TOKYO BAY", PERFORMANCE OF CONCRETE IN MARINE ENVIRONMENT, ACI SPECIAL PUBLICATION SP-65, 1980.
304. MALHOTRA, V.M., CARETTE, G.G., BRENNER, T.W., "DURABILITY OF CONCRETE IN MARINE ENVIRONMENT CONTAINING GRANULATED BLAST FURNACE SLAG, FLY ASH, OR BOTH", PERFORMANCE OF CONCRETE IN MARINE ENVIRONMENT, ACI SPECIAL PUBLICATION SP-65, 1980.
305. MANNING, J.T., "IS A CONCRETE SHIP A FLOATING TANK?", CONCRETE SHIPS AND FLOATING STRUCTURES CONVENTION, ROTTERDAM, NOV. 1979.
306. MARION, H.A., "EKOFISK STORAGE TANK," RINA, REPT. : PAPER 7, FROM SYMPOSIUM ON OCEAN ENGINEERING, NOVEMBER 1974.

SUBJECT: REINFORCED CONCRETE APPLICABLE TO FLOATING MARINE STRUCTURES

307. MARSHALL, A.L., "CONCRETE FOR MARINE TRANSPORT AND STORAGE OF CRYOGENIC LIQUIDS," EUR. OFFSHORE PET. CONF. AND EXHIBIT, PROC., VOL. 1, PP 225-232, 1978.
308. RAST, R.F., "THE ARCO LPG TERMINAL VESSEL", CONCRETE SHIPS AND FLOATING STRUCTURES CONVENTION, BERKELEY, SEPT. 1975.
309. MASUBUCHI, E.K., "MATERIALS FOR OCEAN ENGINEERING, FIRST EDITION. " MIT PRESS, CAMBRIDGE, MASS., 496 P, AND APPENDIX, 1970.
310. MATHER, K., "CONCRETE WEATHERING AT TREAT ISLAND, MAINE", PERFORMANCE OF CONCRETE IN MARINE ENVIRONMENT, ACI SPECIAL PUBLICATION SP-65, 1980.
311. MATSUSHITA, H., "FUNDAMENTAL STUDY OF FATIGUE PROPERTIES OF CONCRETE IN THE WATER," PROC. JPN. CONGR. MATER. RES. 21ST, TOKYO, OCTOBER 1977.
312. MATSUISHI, M., NISHIMAKI, K., TAKESHITA, H., IWATA, S., AND SUHARA, T., "ON THE STRENGTH OF NEW COMPOSITE STEEL-CONCRETE MATERIAL FOR OFFSHORE STRUCTURE," PROC. OTC, VOL. I, PP 589-594, 1977, (4 REF).
313. MATSUISHI, M., NISHIMAKI, K., TAKESHITA, H., IWATA, S., ZUSEN, H., AND SUHARA, T., "ON THE NEW COMPOSITE STEEL-PRESTRESSED CONCRETE STRUCTURAL MODULE FOR OFFSHORE STRUCTURES," PROC. OTC, VOL. II, NO. 3158, PP 949-956, 1978, (3 REF).
314. MAXSON, D.G., AND ACHENBACH, G.D., "PROPERTIES OF CONCRETE IN CONTACT WITH PRESSURED HYDROCARBONS AND SEAWATER," PROC. OTC, VOL. III, PP 507-512, 1975, (9 REF).
315. MAYFIELD, J.G., STRONBECK, E.E., OLIVIER, J.C., AND WILKINS, J.R., "INSTALLATION OF THE PILE FOUNDATION FOR THE COGNAC PLATFORM," PROC. OTC, VOL. II, NO 3497, PP 1221-1232, 1979, (4 REF).
316. MAXWELL-COOK, P.V., "CONCRETE SEA STRUCTURES," CONCRETE SEA STRUCTURES SYMPOSIUM PROC., PUBL. BY FEDERATION INTERNATIONALE DE LA PRECONSTRANTE, LONDON, ENGLAND, 1972.
317. MC DOWELL, D.M., "GENERAL RESEARCH PROBLEMS IN THE DESIGN OF OFF-SHORE STRUCTURES", PROC. OFF-SHORE STRUCTURES, PP. 165-170, LONDON, OCT. 1974.
318. MC LEOD, I.L., "CONSTRUCTION OF THE NINIAN CENTRAL PLATFORM FOR THE BRITISH NORTH SEA," OTC, VOL. 1, PP 233-242, 1979.
319. MEHTA, P.K., AND HAYNES, H., "DURABILITY OF CONCRETE IN SEAWATER," ASCE JOURNAL, STRUCTURAL DIV., VOL. 101, NO. 8, PP 1679-1686, AUGUST 1975.

SUBJECT: REINFORCED CONCRETE APPLICABLE TO FLOATING MARINE STRUCTURES

320. MEHTA, P.K., "DURABILITY OF CONCRETE IN MARINE ENVIRONMENT--A REVIEW", PERFORMANCE OF CONCRETE IN MARINE ENVIRONMENT, ACI SPECIAL PUBLICATION SP-65, 1980.
321. MEINEN, E., "LNG ENCLOSURE DESIGN M-2, TESTS SHOW BEST RETAINING WALL," OIL GAS J., VOL. 77, NO. 21, PP 67-70, 1979.
322. "MILLION-BARREL CONCRETE STORAGE TANK NEARS COMPLETION," OCEAN INDUSTRY, VOL. 8, NO. 2, P 64, 1973, (0 REF).
323. MISHUTIN, V.A., "INVESTIGATION OF SHIPBUILDING CONCRETES," NAVAL SHIP SYSTEMS COMMAND WASHINGTON, D.C., SCIENTIFIC DOCUMENTATION DIVISION (404028), APRIL 1969.
324. MISHUTIN, V.A., FEDIN, Y.I., AND YAKOVLEVA, R.V., "THE INFLUENCE OF STEAM-DRYING REGIMES UPON THE STRENGTH AND FROST RESISTANCE OF SHIPBUILDING CONCRETE," LIBRARY OF CONGRESS, NO. 12, PP 12-14, 1 FIG., 4 TAB., JOINT PUBLICATIONS RESEARCH SERVICE.
325. MDAN, T., HAVER, S., AND VINJE, T., "STOCHASTIC DYNAMIC RESPONSE ANALYSIS OF OFFSHORE PLATFORMS, WITH PARTICULAR REFERENCE TO GRAVITY-TYPE PLATFORMS," PROC. OTC, VOL. III, PP 707-720, 1975, (30 REF).
326. MOE, J., "FEASIBILITY STUDY OF PRESTRESSED CONCRETE TANKER SHIPS," PROC. ACI, VOL. 71, PP 617-626, DECEMBER 1974, (11 REF).
327. MOKSNES, J., "CONDEEP PLATFORMS FOR THE NORTH SEA - SOME ASPECTS OF CONCRETE TECHNOLOGY," PROC. OTC, VOL. III, PP 339-350, 1975, (10 REF).
328. MONNIER, T., "CRACK-WIDTH CALCULATIONS FOR CONCRETE OFFSHORE STRUCTURES," INSTITUTE TNO, DELFT, NETHERLANDS, N77-13466/6ST NTIS REPORT NO.: BI-75-95.
329. MORGAN, R.G., "CONCRETE SHIPS," CONCRETE SEA STRUCTURES SYMPOSIUM PROC., PUBL. BY FEDERATION INTERNATIONALE DE LA PRECONSTRAINTE, LONDON, ENGLAND, 1972.
330. MORGAN, R.G., "OBITUARY OF A PIONEER, THE COASTER SS ARMISTICE," CONCRETE PUBLICATION NO. 2, VOL. 4, PP 57-61, FEB 1970, (5 REF).
331. MORGAN, R.G., "USE OF CONCRETE AS A HULL MATERIAL FOR OFFSHORE VESSELS," 2ND INTERNATIONAL OFFSHORE CRAFT CONFERENCE, LONDON, ENGLAND, BSRA NO. 46,800, 14 PP, 1976, (45 REF).
332. MORGAN, R.G., "DEVELOPMENT OF THE CONCRETE HULL," RINA, ENGLAND, PROCEEDINGS OF CONFERENCE ON CONCRETE SHIPS AND FLOATING STRUCTURES, 21 PP, LONDON, MARCH 3-4, 1977, (63 REF).

SUBJECT: REINFORCED CONCRETE APPLICABLE TO FLOATING MARINE STRUCTURES

333. MORGAN, R.G., "HISTORY OF AND EXPERIENCE WITH CONCRETE SHIPS", CONCRETE SHIPS AND FLOATING STRUCTURES CONVENTION, BERKELEY, SEPT. 1975.
334. MUCKLE, W., "MATERIALS FOR SHIP STRUCTURES," TRANS. NORTH EAST COAST INST. ENG. SHIPBUILD, VOL. 92, NO. 6, PP 149-166, JULY 1976.
335. MULLER, J. "STRUCTURAL CONSIDERATIONS AND CONFIGURATIONS II", CONCRETE SHIPS AND FLOATING STRUCTURES CONVENTION, BERKELEY, SEPT. 1975.
336. "MULTI-PURPOSE PRESTRESSED CONCRETE PLATFORM DESIGN," OCEAN INDUSTRY, VOL. 10, NO. 2, P 183, 1975, (0 REF).
337. MUNGER, C. G., "SULFIDES - THEIR AFFECT ON COATINGS AND SUBSTRATES. " NACE PUBL., PAPER 1, P. 1. 1-1.9, 1977.
338. MURADKA, J.S., "ANTI-FOULING CONCRETE-PRELIMINARY REPORT," NAVAL CIVIL ENGINEERING LAB., NATIONAL MARITIME RESEARCH CENTER, GALVESTON, REPT. NO. N-1211.
339. NAAMAN, A.E., "PERFORMANCE CRITERIA FOR FERROCEMENT," JOURNAL OF FERROCEMENT, VOL. 9, NO. 2, PP 75-92, APRIL 1979, (27 REF).
340. NATARAJA, R., AND KIRK, C.L., "DYNAMIC RESPONSE OF A GRAVITY PLATFORM UNDER RANDOM WAVE FORCES," PROC. OTC, VOL. III, PP 199-208, 1977, (13 REF).
341. "NEW CONCEPT: CONCRETE SEMI-SUBMERSIBLE LNG PLANT," OCEAN INDUSTRY, VOL. 12, NO. 10, PP 49, 1977, (0 REF).
342. NIEDERHOFF, A.E., AND ASCO, M., "LIGHT-WEIGHT PUMICE CONCRETE," ASCE TRANS., VOL. 115, PP 590-610, 1950, (13 REF).
343. NIMITYONGSKUL, P, BOR-SHIUN, CHEN AND KARASUDHI, P., "IMPACT RESISTANCE OF FERROCEMENT BOAT HULLS," JOURNAL OF FERROCEMENT, VOL. 10, NO. 1, JANUARY 1980, (9 REF).
344. NISHIBAYASHI, S., YAMURA, K., INOUE, S., "DURABILITY OF CONCRETE IN SEA WATER: METHOD OF ACCELERATED TESTING AND EVALUATION", PERFORMANCE OF CONCRETE IN MARINE ENVIRONMENT, ACI SPECIAL PUBLICATION SP-65, 1980.
345. NORRIS, C.F., "WHY NOT FERRO-CEMENT ?" MARINE TECHNOLOGY, VOL. 6, NO. 1, PP 43-47, JANUARY 1969, (0 REF).
346. "NORWEGIAN CODE OF PRACTICE FOR CONCRETE STRUCTURES, COMPUTATION AND DESIGN", NORWEGIAN STANDARDS FEDERATION, NS 3473, NORWAY, 1978.

SUBJECT: REINFORCED CONCRETE APPLICABLE TO FLOATING MARINE STRUCTURES

347. O'DISCOLL, P., "THE CASE OF THE CONCRETE COASTERS," CONCRETE PUBLICATION NO. 8, VOL. 10, PP 17-20, AUGUST 1976, (0 REF).
348. OKADA, K., MIYAGAWA, T. "CHLORIDE CORROSION OF REINFORCED STEEL IN CRACKED CONCRETE", PERFORMANCE OF CONCRETE IN MARINE ENVIRONMENT, ACI SPECIAL PUBLICATION SP-65, 1980.
349. O'NEIL, E.F., "STUDY OF REINFORCED CONCRETE BEAMS EXPOSED TO MARINE ENVIRONMENT", PERFORMANCE OF CONCRETE IN MARINE ENVIRONMENT, ACI SPECIAL PUBLICATION SP-65, 1980.
350. "OFFSHORE INSTALLATIONS: GUIDANCE ON DESIGN AND CONSTRUCTION", U.K. DEPARTMENT OF ENERGY, 1977.
351. PAGE, C.L., AL KALAF, M.N., AND RITSHIE, A.G.B., "STEEL/MORTAR INTERFACES: MECHANICAL CHARACTERISTICS AND ELECTROCAPILLARITY", CEMENT AND CONCRETE RESEARCH, VOL. 8, PP 481-490, PERGAMON PRESS, INC., 1978, (15 REF).
352. "PAKISTAN COMPANY ORDERS FLOATING AMMONIA/UREA PLANT," OCEAN INDUSTRY, VOL. 14, NO. 1, P 76, 1979, (0 REF).
353. PATERSON, W.S., "FATIGUE OF REINFORCED CONCRETE IN SEA WATER", PERFORMANCE OF CONCRETE IN MARINE ENVIRONMENT, ACI SPECIAL PUBLICATION SP-65, 1980.
354. PAULING, J.R., "SHIP STRUCTURAL LOADS FOR CONCRETE SHIPS AND VESSELS", CONCRETE SHIPS AND FLOATING STRUCTURES CONVENTION, BERKELEY, SEPT. 1975.
355. PAYER, H.G., AND LONGREE, W.D., "DESIGN, ANALYSIS AND CONSTRUCTION OF THE RESEARCH PLATFORM "NORDSEE"," PROC. OTC, VOL. 1, PP 223-233, 1975, (4 REF).
356. PENZIEN, J., TSENG, W.S., "SEISMIC ANALYSIS OF GRAVITY PLATFORMS INCLUDING SOIL-STRUCTURE INTERACTION EFFECTS," PROC. OTC, PP 646-655, 1976, (12 REF).
357. PERENCHIO, W.F., AND KRIEGER, P., "SOME PHYSICAL PROPERTIES OF HIGH-STRENGTH CONCRETE", PCA, 6 PP, 1978, (0 REF).
358. PERSON, A., "QUALIFICATION PROGRAM FOR USE OF CONCRETE FOR MARINE LNG TANKAGE," PRESENTED AT SNAME, APRIL 14, 1977, 20 PP, 12 FIG., (4 REF).
359. PERSON, A., CHEN, S., HANSEN, G., HARTT, M., OZUDOGRU, Y., "USE OF PRESTRESSED CONCRETE FOR SHIP HULLS, SOME DESIGN CONSIDERATIONS AND MATERIAL PRACTICES", GLOBAL MARINE DEVELOPMENT INC. RPT-04074,0013, SEPT. 1979.

247

SUBJECT: REINFORCED CONCRETE APPLICABLE TO FLOATING MARINE STRUCTURES

360. PEYRONNET, J.P., TRINH, J., KAVYRCHINE, M., AND SEGUIN, M., "EXPERIMENTAL STUDY ON THE BEHAVIOR OF CONCRETE STRUCTURAL ELEMENTS IN NATURAL SEA WATER," PROC. OTC, VOL. IV, NO. 3012, PP 371-378, 1977, (5 REF).
361. "PHILLIPS EKOFISK MILLION BARREL OIL STORAGE TANK NEARS COMPLETION," OCEAN INDUSTRY, VOL. 7, NO. 7, PP 33-35, 1972, (0 REF).
362. PICARD, A., AND LACHANCE, L., "PRELIMINARY FATIGUE TESTS ON FERRO-CEMENT PLATES," CEMENT AND CONCRETE RESEARCH, VOL. 4, PP 967-978, PERGAMON PRESS, INC., 1974 (3 REF).
363. PIKE, D., "THE DUNLIN "A" TOW-OUT," SHIP AND BOAT INTERNATIONAL, VOL. 30, NO. 9, PP 37-39, REED INDUSTRIAL PRESS LTD., LONDON, ENGLAND.
364. PLANEIX, J.M., PINCEMIN, M., BRONDEL, A., "PROBLEM AREAS IN THE DESIGN, CALCULATION AND CLASSIFICATION OF OFF-SHORE STRUCTURES", PROC. OFF-SHORE STRUCTURES, PP. 155-164, OCT. 1974.
365. "PLATFORMS," OCEAN INDUSTRY, VOL. 8, NO. 12, PP 36-38, 1973, (0 REF).
366. PLISKIN, L., "REMOVAL OF CONCRETE GRAVITY PLATFORMS," PROC. OTC, VOL. II, NO 3475, PP 1009-1013, 1979, (2 REF).
367. PLISKIN, L., LACROIX, R., AND FRANKHOUSER, H.S., "SEA-TANK - PRESTRESSED CONCRETE UNDERWATER OIL STORAGE FOR DEEP WATER," PROC. OTC, HOUSTON, VOL. II, 1972, (0 REF).
368. POOL, J.H., "GEOTECHNICAL ASPECTS OF GRAVITY STRUCTURES," OCEAN ENGINEERING, VOL. 10, NO. 3, NOVEMBER 1976, (0 REF).
369. "PRESTRESSED CONCRETE PROPOSED FOR LNG CARRIERS," OCEAN INDUSTRY, VOL. 9, NO. 2, PP 104-112, 1975, (0 REF).
370. "PRESTRESSED CONCRETE SHIPS, FIRST REPORT- CONSIDERATION FOR DESIGN", FEDERATION INTERNATIONALE DE LA PRECONTRAINTTE, NOV 1975, (0 REF).
371. "PRESTRESSED CONCRETE TANK FOR SUB-SEA OIL STORAGE," OCEAN INDUSTRY, VOL. 4, NO. 12, PP 40-41 1969, (0 REF).
372. "PROCEEDINGS: THIRD INTERNATIONAL CONGRESS OF MARINE CORROSION AND FOULING," INTERNATIONAL CONGRESS ON MARINE COR. + FOUL. (3RD) BOOK NO. 1026, PP 73, 1972.
373. RAITHBY, K.D., "FLEXURAL FATIGUE BEHAVIOR OF PLAIN CONCRETE", FATIGUE OF ENGINEERING MATERIALS AND STRUCTURES, VOL. 2, PP 269-278, 1975, (11 REF).

248

SUBJECT: REINFORCED CONCRETE APPLICABLE TO FLOATING MARINE STRUCTURES

374. RAPU, B., "THE STRUCTURAL APPRAISAL OF CONCRETE SHIPS," CONCRETE SHIPS AND FLOATING STRUCTURES 77, 15 PP, 1977.
375. "READY-FOR-OPERATION DECK MATED TO CONCRETE GRAVITY PLATFORM," OCEAN INDUSTRY, VOL. 11, NO. 8, PP 52-55, 1976, (0 REF).
376. "RECOMMENDATION OFR THE DESIGN AND CONSTRUCTION OF CONCRETE SEA STRUCTURES", FEDERATION INTERNATIONALE DE LA PRECONTRAINTE, 3RD EDITION, FIP/6/1, C AND CA, WEXHAM SPRINGS, SLOUGH, JULY 1977.
377. REED, W.E., "CATHODIC PROTECTION (CITATIONS FROM THE NTIS DATA BASE) " NATIONAL TECHNICAL INFORMATION SERVICE, SPRINGFIELD, VA., (391 812), REPT. FOR 1964-APRIL 1979.
378. REED, W.E., "CATHODIC PROTECTION, VOLUME 3, 1977-APRIL, 1979 (CITATIONS FROM THE ENGINEERING INDEX DATA BASE," NATIONAL TECHNICAL INFORMATION SERVICE, SPRINGFIELD, VA (391 812), REPT. FOR 1977-APRIL 79.
379. REED, W.E., "SEA WATER CORROSION," VOLUME 2, 1976-JANUARY, 1979 (A BIBLIOGRAPHY WITH ABSTRACTS), NATIONAL TECHNICAL INFORMATION SERVICE, SPRINGFIELD, VIRGINIA, (391 812), REPT. FOR 1976-JANUARY 1979,
380. REGOURD, M. "PHYSICO-CHEMICAL STUDIES OF CEMENT PASTES, MORTARS, AND CONCRETE EXPOSED TO SEA WATER", PERFORMANCE OF CONCRETE IN MARINE ENVIRONMENT, ACI SPECIAL PUBLICATION SP-65, 1980.
381. "REMOVABLE CONCRETE DOME BUOYANCY CELL CLOSURE SYSTEM," OCEAN INDUSTRY, VOL. 11, NO. 12, P 87, 1977, (0 REF).
382. RIDER, R.G., AND HEIDERSBACH, R.H., "THE EFFECTS OF SEA WATER ON THE STRUCTURAL PROPERTIES OF METAL-FIBER REINFORCED CONCRETE," PROC. DTC, VOL. II, NO. 3193, PP 1239-1242, 1978, (25 REF).
383. RIDLEY, T., MALONE, A.W., MCLEOD, R.D., "RAPID DESIGN FOR CONCRETE GRAVITY PLATFORMS," OVE ARVP + PARTNERS, LONDON, VOL. 41, NO. 9, PP 39-41, SEPTEMBER 1977.
384. RIDLEY, T., MALONE, A.W., AND MCLEOD, R.D., "RAPID DESIGN FOR CONCRETE GRAVITY PLATFORMS," NORWOOD PUBLICATIONS LTD., ELM STREET, LONDON, ENGLAND, VOL. 41, NO. 9, PP 39-41, (3 REF).
385. RILEY, J.G., "THE CONSTRUCTION OF ARTIFICIAL ISLANDS IN THE BEAUFORT SEA," PROC. DTC, VOL. I, PP 211-222, 1975, (3 REF).
386. RIXON, W.R., "DURABILITY OF CONCRETE IN THE MARINE ENVIRONMENT", CONCRETE SHIPS AND FLOATING STRUCTURES CONVENTION, ROTTERDAM, NOV. 1979.

SUBJECT: REINFORCED CONCRETE APPLICABLE TO FLOATING MARINE STRUCTURES

387. RDREN, E.M.Q., AND FURNES, O., "BEHAVIOUR OF STRUCTURES AND STRUCTURAL DESIGN - STATE OF THE ART," NOR. VERITAS PUBL. NO. 100, P. 21, OCTOBER 1976.
388. RDREN, E.M.Q., AND FURNES, O., "PERFORMANCE OF OFFSHORE STRUCTURES - STATE OF THE ART," NORW. MARIT. RESEARCH, VOL. 5, NO. 1, PP 14-29, 1977.
389. RDREN, E.M., AND FURNES, O., "STATE OF THE ART: BEHAVIOUR OF STRUCTURES AND STRUCTURAL DESIGN," MAR. SCI. COMMUN., VOL. 4, NO. 3, PP 179-220, 1978.
390. RDREN, E.M.Q., FOSS, I.J., AND FURNES, O., "FIXED OFFSHORE STEEL AND CONCRETE PLATFORMS," SNAME 1977 SPRING MEETING AND STAR SYMPOSIUM, PP 81-98, (26 REF).
391. ROXBURGH, G., "THE MULTI- ROLE OFFSHORE STRUCTURE," OCEAN ENGINEERING, VOL. 10, NO. 3, PP 62-73, NOVEMBER 1976, (0 REF).
392. "RULES FOR THE DESIGN, CONSTRUCTION AND INSPECTION OF OFFSHORE STRUCTURES", DET NORSKE VERITAS, NORWAY, 1979.
393. SANSONETTI, S.J., "TO PREVENT CORROSION AT SEA - THINK ALUMINUM ANODES," PROC. OTC, VOL. I, 1969, (19 REF).
394. SARE, P.N., AND YEE, A.A., "OPERATIONAL EXPERIENCE WITH PRESTRESSED CONCRETE BARGES," SNAME, PRESENTED AT HAWAII MEETING OF SNAME, 18 PP.
395. SCANLON, J.M. JR., "CURRENT PROGRAM AND FUTURE CORPS OF ENGINEERS PLANS FOR THE TREAT ISLAND EXPOSURE STATION", PERFORMANCE OF CONCRETE IN MARINE ENVIRONMENT, ACI SPECIAL PUBLICATION SP-65, 1980.
396. SCHMITT, R.J., AND PHELPS, E.H., "CORROSION PERFORMANCE OF CONSTRUCTIONAL STEELS IN MARINE APPLICATION," PROC. OTC, VOL I, 1969, (30 REF).
397. SCHRADER, E., DIKEDU, J., GILL, D., "DETERIORATION AND REPAIRS OF NAVIGATION LOCK CONCRETE", PERFORMANCE OF CONCRETE IN MARINE ENVIRONMENT, ACI SPECIAL PUBLICATION SP-65, 1980.
398. SHCUPACK, M., "BEHAVIOR OF 20 POST-TENSIONED TEST BEAMS SUBJECT TO UP TO 2200 CYCLES OF FREEZING AND THAWING IN THE TIDAL ZONE AT TREAT ISLAND, MAINE", PERFORMANCE OF CONCRETE IN MARINE ENVIRONMENT, ACI SPECIAL PUBLICATION SP-65, 1980.
399. "SCRIPPS PLANS RESEARCH ISLAND IN THE SEA," OCEAN INDUSTRY, VOL. 6, NO. 8, 1971, (0 REF).

250

SUBJECT: REINFORCED CONCRETE APPLICABLE TO FLOATING MARINE STRUCTURES

400. "SECOND GENERATION CONCRETE PLATFORM," OCEAN INDUSTRY, VOL. 14, NO. 2, PP 84-88, 1979, (0 REF).
401. SEKI, H., "DETERIORATION OF CONCRETE OF COASTAL STRUCTURES IN JAPAN," DURABILITY OF CONCRETE, PP 293-315, PUBLISHED BY ACI (SP-47), DETROIT, MICHIGAN, 1975. (13 REF).
402. "SEMI-SUBMERSIBLE LNG PLANT USES CONCRETE STORAGE BUDY," OCEAN INDUSTRY, VOL. 13, NO. 2, PP 95, 1978, (0 REF).
403. SHAH, S.P., AND KEY, W.H. JR., "FERRO-CEMENT AS A MATERIAL FOR OFFSHORE STRUCTURES," PROC. OTC, HOUSTON, VOL. II, 1971, (9 REF).
404. SHAH, S.P., AND KEY, W.H., "IMPACT RESISTANCE OF FERRO-CEMENT," JOURNAL OF STRUCTURAL DIVISION ASCE, VOL. 98, NO. ST1, JAN. 1972, (0 REF).
405. SHAH, S.P. AND NAAMAN, A.E., "CRACK CONTROL IN FERROCEMENT AND ITS COMPARISON WITH REINFORCED CONCRETE," JOURNAL OF FERROCEMENT, VOL. 8, NO. 2, PP 67-80, APRIL 1978, (38 REF).
406. SHALDN, R., AND RAPHAEL, M., "INFLUENCE OF SEA WATER ON CORROSION OF REINFORCEMENT," PROC. ACI, VOL. 55, PP 1251- 1268, JAN.- JUNE 1959, (14 REF).
407. SHARP, J.V., "USE OF STEEL AND CONCRETE IN THE CONSTRUCTION OF NORTH SEA OIL PRODUCTION PLATFORMS," J. MATER. SCI., VOL. 14, NO. 8, PP 1773-1799, AUGUST 1979.
408. SHARP, J.V., PULLAR-STRECKER, P., "A DESCRIPTION OF THE 'CONCRETE-IN-THE-OCEANS' RESEARCH PROGRAMME", CONCRETE SHIPS AND FLOATING STRUCTURES CONVENTION, ROTTERDAM, NOV. 1979.
409. SHARP, J.V., PULLAR-STRECKER, P., "THE UNITED KINGDOM CONCRETE-IN-THE-OCEANS PROGRAM", PERFORMANCE OF CONCRETE IN MARINE ENVIRONMENT, ACI SPECIAL PUBLICATION SP-65, 1980.
410. SHAW, P., "QUALITY ASSURANCE OF PROPOSED OFFSHORE CONCRETE STRUCTURES," RINA, PAPER NO. 10, SYMPOSIUM ON OCEAN ENGINEERING, NOVEMBER 1974.
411. SHAW, P.G.H., COATES, A.D., HOBBS, R., AND SCHUMM, W., "ANALYTICAL AND FIELD DATA STUDIES OF THE DYNAMIC BEHAVIOR OF GRAVITY STRUCTURES AND FOUNDATIONS," PROC. OTC, VOL. IV, NO. 3008, PP 329-340, 1977, (16 REF).
412. SHERMAN, D.R., "PULLOUT BOND STRENGTH OF CONCRETE IN A STEEL PIPE," PROC. OTC, VOL. II, PP 593-599, 1975, (5 REF).

SUBJECT: REINFORCED CONCRETE APPLICABLE TO FLOATING MARINE STRUCTURES

413. SHIMADA, H., OKADA, H., AND NISHI, H., "DEVELOPMENT OF SEA WATER CORROSION RESISTANT STEEL BARS FOR OFFSHORE CONCRETE STRUCTURES," PROC. OTC, VOL. II, NO. 3194, PP 1243-1248, 1978, (5 REF).
414. SIGNIFICANCE OF TESTS AND PROPERTIES OF CONCRETE AND CONCRETE MAKING MATERIALS, ASTM SPECIAL TECHNICAL PUBLICATION, NO. 169-A, PHILADELPHIA, PA., 1966.
415. SIMPSON, M.G., "FATIGUE OF FERRO-CEMENT," NAVAL POSTGRADUATE SCHOOL MONTEREY, CALIFORNIA, MASTER'S THESIS, JUNE 1974.
416. SIMPSON, J., "UNDERWATER CONCRETE STRUCTURES," FOXLOW PUBLICATIONS LIMITED, DOCK AND HARBOUR AUTHORITY, VOL. 52, N613, PP 516-518.
417. SJODERDSSMA, G.W., "GENERAL APPRAISAL OF OFF-SHORE STRUCTURES", PROC. OFF-SHORE STRUCTURES, PP 61-67, LONDON, OCT. 1974.
418. SKOULIKIDIS, TH.N., "CORROSION PROBLEMS IN GREECE: THE CONTRIBUTION OF THE LABORATORY OF PHYSICAL CHEMISTRY AND APPLIED ELECTROCHEMISTRY OF THE NATIONAL TECHNICAL UNIVERSITY OF ATHENS TO THEIR SOLUTION (1)," CORROSION PREVENTION CONTROL, VOL. 26, NO. 3, PP 5-8, JUNE 1979.
419. SLETTEN, R., FUJIED, S., AND ROLAND, B., "IN-SERVICE INSPECTION OF NORTH SEA STRUCTURES," PROC. OTC, VOL. IV, PP 181-192, 1977, (5 REF).
420. "SLIPFORM TESTED FOR DEEP WATER PLATFORM," OCEAN INDUSTRY, VOL. 10, NO. 8, 1975, (0 REF).
421. SMITH, D.A., "FEASIBILITY STUDY FOR CONCRETE SUBMARINE", CONCRETE SHIPS AND FLOATING STRUCTURES CONVENTION, BERKELEY, SEPT. 1975.
422. SMITH, M., "CATHODIC PROTECTION. (CITATIONS FROM THE NTIS DATA BASE)," NTIS/PS-78/046679.
423. SMITH, M.F., "CATHODIC PROTECTION (CITATIONS FROM THE NTIS DATA BASE)," NTIS, SPRINGFIELD, VA., REPT. FOR 1964-MAY 78.
424. SMITH, M.F., "SEA WATER CORROSION. VOLUME 2. 1976-1977 (A BIBLIOGRAPHY WITH ABSTRACTS)," NTIS, SPRINGFIELD, VA., REPT. FOR 1976-77.
425. SMITH, M.F., "CATHODIC PROTECTION. VOL. 2. 1974-MAY 1977: CITATIONS FROM THE ENGINEERING INDEX DATA BASE," NTIS/PS-77/0430/7EES.
426. SMITH, M.F., "CATHODIC PROTECTION. VOLUME 2. 1974-1976 (CITATIONS FROM THE ENGINEERING INDEX DATA BASE)," NTIS, SPRINGFIELD, VA., REPT. FOR 1974-76.



SUBJECT: REINFORCED CONCRETE APPLICABLE TO FLOATING MARINE STRUCTURES

427. SMITH, K., "CATHODIC PROTECTION, VOL. 3, 1977-MAY, 1978. (CITATIONS FROM THE ENGINEERING INDEX DATA BASE)," NTIS/PS-78/0468/8ENS.
428. SMITH, M.F., "CORROSION OF REINFORCED CONCRETE (CITATIONS FROM THE ENGINEERING INDEX DATA BASE)," NTISEARCH NTIS/PS-78/6EES, 1970-OCT. 1978.
429. SMITH, M.F., "CORROSION OF REINFORCED CONCRETE (CITATIONS FROM THE NTIS DATA BASE)," NTIS/PS-78/1112/8ENS.
430. SOROS, P., AND KOMAN, B., "ARTIFICIAL ISLAND TRANS-SHIPMENT TERMINAL," PROC. OTC, HOUSTON, VOL. II, PP 657-663, 1974, (0 REF).
431. SPRADBROW, B.J. AND WIKLUND, K.M., "DESIGN, SERIES PRODUCTION AND PROMOTION OF FERROCEMENT VESSELS," JOURNAL OF FERROCEMENT, VOL. 10, NO. 1, PP 19-30, 1980, (0 REF).
432. SPRIGGS, T.F., "CONCEPTUAL DESIGN OF A MAN-MADE ISLAND FOR A SEA-WATER DESALTING AND POWER PLANT," PROC. OTC, HOUSTON, VOL. I, 1971, (9 REF).
433. SQUIRE, H.E., "CONCRETE FOR RESISTING SEA WATER," PROC. ACI, VOL. XXV, PP 751-762, 1929, 25TH CONVENTION, (0 REF).
434. STACHIW, J.D., "CONCRETE DEEP SUBMERGENCE HOLLOW SHELL STRUCTURES" , JOURNAL OF STRUCTURAL DIVISION ASCE, VOL. 95, NO ST12, DEC 1969, (3 REF).
435. STACHIW, J.D., "NONMETALLIC MATERIAL FOR OFFSHORE ENGINEERING", SNAME 1977 SPRING MEETING AND STAR SYMPOSIUM, PP 357-367, (23 REF).
436. "STACKED CONCRETE ELEMENTS FORM LEGS FOR SHALLOW-WATER PLATFORM," OCEAN INDUSTRY, VOL. 11, NO. 5, PP 63-64, 1976, (0 REF).
437. STANFORD, A.E., "CONCRETE SHIP ECONOMICS," CONCRETE SHIPS AND FLOATING STRUCTURES 77, PP 25, (10 REF).
438. STANFORD, A.E., FINSTERWALDER, K., AND CARVILL, W.C., "FOR LNG -- A CONCRETE ANSWER," BRITISH SHIP RESEARCH ASSOCIATION NO. 46,629, 12 PP, 1976, (19 REF).
439. STANFORD, A.E., FINSTERWALDER, K., AND CARVILL, W.C., "CONCRETE LNG-VESSEL DESIGN REDUCES MAINTENANCE, IMPROVES SAFETY," OIL GAS JOURNAL, VOL. 74, NO. 51, PP 74-76, DECEMBER 20, 1976.
440. STEPANEK, G., AHLERS, E., AND MCKEE, K.E., "COMPARISON OF OFFSHORE AIRPORT CONSTRUCTION," PROC. OTC, VOL. II, 1969, (0 REF).



SUBJECT: REINFORCED CONCRETE APPLICABLE TO FLOATING MARINE STRUCTURES

441. STRUNGE, C., "SUBMARINE PLACING OF CONCRETE BY THE TREMIE-METHOD," PROC. OTC, HOUSTON, VOL. II, 1970. (6 REF).
442. STUBBS, S.B., "DEEP WATER STRUCTURES IN CONCRETE," SOCIETY OF PETROLEUM ENGINEERS, PREPRINT, 16 PP, REPT. NO. AIME #SPE-4309, (10 REF).
443. STUBBS, S.B., "FUTURE PLATFORM DESIGN," OCEAN ENGINEERING, VOL. 10, NO. 3, PP 10-20, NOVEMBER 1976, (0 REF).
444. STUBBS, S.B., "SOME ASPECTS OF THE DESIGN AND CONSTRUCTION OF CONCRETE PLATFORM FOR THE NORTH SEA," ASME PAPER NO. 74-PET-55, FOR MEETING SEPTEMBER 15-18, P 13, 1974.
445. STUBBS, S.B., "SEABED FOUNDATION CONSIDERATIONS FOR GRAVITY PLATFORMS", PROC. OFF-SHORE STRUCTURES, PP 67-74, LONDON, OCT. 1974.
446. SU, C.F., LEE, Y.H., AND CHANG, R.H., "THE DESIGN AND CONSTRUCTION OF FERROCEMENT CAISSONS WITH CORRUGATED FRICTIONAL BASE PLATES USED IN THE BREAKWATER OF HSIN-KANG FISHING HARBOR," JOURNAL OF FERROCEMENT, VOL. 9, NO. 2, PP 65-73, APRIL 1979, (4 REF).
447. SWAMY, R.N., AND MANGAT, P.S., "A THEORY FOR THE FLEXURAL STRENGTH OF STEEL FIBER REINFORCED CONCRETE," CEMENT AND CONCRETE RESEARCH, VOL. 4, PP 313-325, PERGAMON PRESS, INC., 1974, (17 REF).
448. TAM, P.A., "OFFSHORE STRUCTURE MODEL TESTING FACILITY," PROC. OTC, HOUSTON, VOL. I, 1971, (0 REF).
449. TAYLOR, D.M., "MATERIALS FOR THE SEA," OCEAN INDUSTRY, VOL. 5, NO. 7, PP 23-27, 1970, (0 REF).
450. TAYLOR, H.P.J., AND SHARP, J.V., "FATIGUE IN OFFSHORE CONCRETE STRUCTURES," CEMENT + CONCRETE ASSOC., STRUCT. ENG., VOL. 56A, NO. 3, PP 69-76, MARCH 1978.
451. TAYLOR, R.E., "A PRELIMINARY STUDY OF THE STRUCTURAL DYNAMICS OF GRAVITY PLATFORMS," PROC. OTC, HOUSTON, VOL. III, 1975, (0 REF).
452. TAYLOR, R.E., "STRUCTURAL DYNAMICS OF OFF-SHORE PLATFORMS", PROC. OFF-SHORE STRUCTURES, PP 125-133, LONDON, OCT. 1974.
453. TAYLOR, R.S., AND ANTONAKIS, C.J., "OFFSHORE CONCRETE PLATFORMS AND LIGHTHOUSES," IME, LONDON ENGLAND, INTERNATIONAL MARINE AND SHIPPING CONFERENCE 7-16, 1974.
454. TEBBETT, I.E., BECKETT, C.D., AND BILLINGTON, C.J., "THE PUNCHING SHEAR STRENGTH OF TUBULAR JOINTS REINFORCED WITH A GROUTED PILE," PROC. OTC, VOL. II, NO. 3463, PP 915-926, 1979, (7 REF).

SUBJECT: REINFORCED CONCRETE APPLICABLE TO FLOATING MARINE STRUCTURES

455. THORNTON, H.T. JR., "NATURAL WEATHERING EXPOSURE STATION FOR CONCRETE AND CONCRETING MATERIAL--TREAT ISLAND, MAINE", PERFORMANCE OF CONCRETE IN MARINE ENVIRONMENT, ACI SPECIAL PUBLICATION SP-65, 1980.
456. TILLY, G.P., "FATIGUE OF STEEL REINFORCEMENT BARS IN CONCRETE: A REVIEW", FATIGUE OF ENGINEERING MATERIALS AND STRUCTURES, VOL. 2, PP 251-268, 1979, (49 REF).
457. THORBE, S., "CONCRETE REGASIFICATION PLATFORM," OCEAN INDUSTRY, VOL. 13, NO. 2, PP 121-125, 1978, (0 REF).
458. THOMAS, G., "FERROCEMENT BOATS," CEMENT RESEARCH INSTITUTE OF INDIA, NEW DELHI, INDIAN CONCRETE JOURNAL, VOL. 45, NO. 8, PP 329-32, 354, AUGUST 1971.
459. TOLOSA, R.T., "FERROCEMENT BOUYS FOR MUSSEL CULTURE," JOURNAL OF FERROCEMENT, VOL. 9, NO. 3, PP 129-133, JULY 1979, (4 REF).
460. TORUM, A., LARSEN, P.K., AND HAFSKJOLD, P.S., "OFFSHORE CONCRETE STRUCTURES - HYDRAULIC ASPECTS," PROC. OTC, HOUSTON, VOL. I, 1974, (23 REF).
461. "TOTAL'S CONCRETE GRAVITY PLATFORM SCHEDULED FOR FRIGG IN JULY," OCEAN INDUSTRY, VOL. 10, NO. 2, PP 99-104, 1975, (0 REF).
462. "TOW-OUT OF THE NINIAN CENTRAL PLATFORM -- THE LARGEST STRUCTURE EVER MOVED BY MAN," RINA (EDITORS), NAVAL ARCHITECT, NO. 5, PP 157-159.
463. TRAGESSER, A.F., DALTON, C., AND KAY, F.J., "PRESSURE GROUTING: AN IMPROVED METHOD OF OFFSHORE STRUCTURE GROUTING," PROC. OTC, HOUSTON, VOL. II, 1974, (0 REF).
464. TROUP, K.D., "INTERNATIONAL OFFSHORE CRAFT CONFERENCE, 2ND, 1976. LONDON, PUBL. BY THOMAS REED IND. PRESS LTD., LONDON, ENGLAND, P. 203, 1977.
465. "TURN OF THE TIDE FOR NORTH SEA CONCRETE," CONCRETE PUBLICATION NO. 11, VOL. 7, PP 22-25, NOV. 1973, (0 REF).
466. TURNER, F.H., "THE CONTRACTOR CONCEPT FOR CRYOGENIC CARRIERS," OCEAN INDUSTRY, VOL. 9, NO. 11, PP 54-56, 1974, (6 REF).
467. TURNER, F.H., AND MANNING, J.T., "CONCRETE SHIPS OF 25,000 TONNES," F.H. TURNER + PARTNERS, LONDON, VOL. 30, NO. 6, PP 41-44, JUNE 1974.
468. TURNER, F.H., "OPTIMIZING THE SIZE OF CONCRETE HULLS", CONCRETE SHIPS AND FLOATING STRUCTURES CONVENTION, BERKELEY, SEPT. 1975.

255

SUBJECT: REINFORCED CONCRETE APPLICABLE TO FLOATING MARINE STRUCTURES

469. TUSCH, K.N., "REPAIR AND PROTECTION OF OFFSHORE STRUCTURES," INT. CONSTR. VOL. 16, NO. 1, PP 20-22, JANUARY 1977.
470. TUUTTI, K. "SERVICE LIFE OF STRUCTURES WITH REGARD TO CORROSION OF EMBEDDED STEEL", PERFORMANCE OF CONCRETE IN MARINE ENVIRONMENT, ACI SPECIAL PUBLICATION SP-65, 1980.
471. TYNES, W.O., "EVALUATION OF ADMIXTURES FOR USE IN CONCRETE TO BE PLACED UNDERWATER," NTIS, REPT. NO. WES-TR-C-76-3, 29 PP 7609.
472. "U.K. NORTH SEA 1975, OCEAN INDUSTRY, VOL. 10, NO. 8, 1975 (0 REF).
473. VAN MANEN, J.D., "MARITIME STRUCTURES AND THEIR MATERIAL SELECTION", CONCRETE SHIPS AND FLOATING STRUCTURES CONVENTION, ROTTERDAM, NOV. 1979.
474. VOS, J., "CONCRETE FOR OTEC: POINTERS FROM EXPERIENCE AND RESEARCH", CONCRETE SHIPS AND FLOATING STRUCTURES CONVENTION, ROTTERDAM, NOV. 1979.
475. WAAGAARD, K., "FLOATING CONCRETE STRUCTURES FOR TRANSPORTATION AND STORAGE OF LNG/LPG", CONCRETE SHIPS AND FLOATING STRUCTURES CONVENTION, ROTTERDAM, NOV. 1979.
476. WAAGAARD, K., "FATIGUE OF OFFSHORE CONCRETE STRUCTURES - DESIGN AND EXPERIMENTAL INVESTIGATIONS," PROC. OTC, VOL. IV, NO. 3009, PP 341-350, 1977, (9 REF).
477. WALKUS, B.R., AND MACKIEWICZ, A., "APPLICATION OF FERROCEMENT SHELLS IN MARINE STRUCTURES," INTERNATIONAL ASSOCIATION FOR SHELL AND SPAT. STRUCT. SYMPOSIUM, PP 335-398, JUNE 18-23, 1973.
478. WATT, B.J., BOAZ, I.B., AND DOWNRICK, D.J., "RESPONSE OF CONCRETE GRAVITY PLATFORMS TO EARTHQUAKE EXCITATIONS," PROC. OTC, VOL. III, PP 633-644, 1976, (11 REF).
479. WATT, B.J., BOAZ, I.B., RUHL, J.A., SHIPLEY, S.A., AND GHOSE, A., "EARTHQUAKE SURVIVABILITY OF CONCRETE PLATFORMS," PROC. OTC, VOL. II, NO 3159, PP 957-973, 1978, (21 REF).
480. WEBSTER, W.C., "BASIC NAVAL ARCHITECTURE CONSIDERATIONS FOR CONCRETE SHIPS AND VESSELS", CONCRETE SHIPS AND FLOATING STRUCTURES CONVENTION, BERKELEY, SEPT. 1975.
481. WEEDEN, S.L., "THERMAL ENERGY FROM THE OCEANS," OCEAN INDUSTRY, VOL. 10, NO. 9, 1975, (0 REF).
482. WEIDLINGER, P., "FLOATING AIRPORT," OCEAN INDUSTRY, VOL. 5, NO. 5, PP 46-49, 1970, (10 REF).

SUBJECT: REINFORCED CONCRETE APPLICABLE TO FLOATING MARINE STRUCTURES

483. WEISS, V., "CRACK DEVELOPMENT IN CONCRETE WITH CLOSELY-SPACED REINFORCEMENT AND IN SIMILAR MATERIALS," CEMENT AND CONCRETE RESEARCH, VOL. 3, PP 189-205, PERGAMON PRESS, INC., 1973, (16 REF).
484. WELSH, F.R., "SOME ASPECTS OF FINANCING CONCRETE VESSELS," CONCRETE SHIPS AND FLOATING STRUCTURES 77, LONDON, PP 8.
485. WERENSKIOLD, K., "MARITIME OPERATIONS RELATIVE TO CONSTRUCTION OF LARGE CONCRETE OFFSHORE STRUCTURES," 4TH INTERNATIONAL CONFERENCE ON PORT AND OCEAN ENGINEERING UNDER ARTIC CONDITIONS, NEWFOUNDLAND MEMORIAL UNIVERSITY, CANADA, SEPTEMBER 1977, PROC., PP 11.
486. WESSON, H.R., LOTT, J.L., FELDMAN, R., CLOSNER, J.J., "THERMAL PERFORMANCE OF A FIRE RESISTANT COATING APPLIED TO PRESTRESSED CONCRETE," AM. GAS ASSOC. OPER. SECT. PROC. 1978.
487. WEST, G.L., "THE APPLICATION OF CONCRETE PONTONS TO RO-RO TERMINAL EQUIPMENT", CONCRETE SHIPS AND FLOATING STRUCTURES CONVENTION, ROTTERDAM, NOV. 1979.
488. WEST, G.L., ROLAND, E.J., "SOME ASPECTS OF NUCLEAR SAFETY AND SHIP DESIGN," TRANS. SNAME, VOL. 75, PP 385-419, 1967, (66 REF).
489. WHANG, B., "COMPARISON STUDY OF ALUMINUM, FERRO-CEMENT, AND FIBER-REINFORCED PLASTIC FOR SMALL CRAFT IN KOREA," NSRDC, BETHESDA, MARYLAND, (387682), REPT. NO. NSRDC-3979, DECEMBER 1972.
490. WIEBENGA, J.G., "DURABILITY OF CONCRETE STRUCTURES ALONG THE NORTH SEA COAST OF THE NETHERLANDS", PERFORMANCE OF CONCRETE IN MARINE ENVIRONMENT, ACI SPECIAL PUBLICATION SP-65, 1980.
491. WIG, R.J., "METHOD OF CONSTRUCTION OF CONCRETE SHIPS," TRANS. SNAME, PP 1-28, 1919, (3 REF).
492. WILSON, D., "HAWAII'S FLOATING CITY DEVELOPMENT PROGRAM. CONCRETE FOR LARGE FLOATING STRUCTURES," HAWAII UNIVERSITY, HONOLULU, DEPT. OF OCEAN ENGINEERING, REPT. NO. UNIHI-SEAGRANT-CR-74-02-TR 4, 1974.
493. WITTMANN, F.H., AND KNAPPE, O.W., "TEMPERATURE INDUCED STRESSES IN CONCRETE," CEMENT AND CONCRETE RESEARCH, VOL. 8, PP 703-710, PERGAMON PRESS, INC., 1978, (6 REF).
494. "WORLD'S LARGEST PRESTRESSED BARGE," CONCRETE PUBLICATION NO. 6, VOL. 10, P 17, JUNE 1976, (0 REF).
495. WYATT, B.S., "CATHODIC PROTECTION OF OFFSHORE STRUCTURES. PART TWO," ANTI-CORROSION METHODS AND MATERIALS, VOL. 24, NO. 5, PP 5, 1977, SAWELL PUBLICATIONS LTD., LONDON EC4, ENGLAND, (6 REF).

SUBJECT: REINFORCED CONCRETE APPLICABLE TO FLOATING MARINE STRUCTURES

496. YAUN, R.L., CHEN, W.F., "BEHAVIOR OF SULFUR-INFILTRATED CONCRETE IN SODIUM CHLORIDE SOLUTION", PERFORMANCE OF CONCRETE IN MARINE ENVIRONMENT, ACI SPECIAL PUBLICATION SP-65, 1980.
497. YEE, A.A., "DESIGN CONSIDERATIONS AND CONFIGURATIONS: THE YEE CONCEPT", CONCRETE SHIPS AND FLOATING STRUCTURES CONVENTION, BERKELEY, SEPT. 1975.
498. YEE, A.A., LUM, K.B.T., AND GOLVED, V.S., "DESIGN AND CONSTRUCTION OF OCEANGOING PRETENSIONED CONCRETE BARGES," PROC. ACI, VOL. 72, PP 125-134, APRIL 1975, (O REF).
499. "30-YEAR-OLD CONCRETE BARGES SPUR NEW CONSTRUCTION," OCEAN INDUSTRY, VOL. 12, NO. 6, PP 91-92, 1977, (O REF).

(258)
19/1

(Margin to trim)

SHIP STRUCTURE COMMITTEE

THE SHIP STRUCTURE COMMITTEE is constituted to prosecute a research program to improve the hull structures of ships and other marine structures by an extension of knowledge pertaining to design, materials and methods of construction.

RADM C. T. Lusk, Jr., USCG (Chairman)
Chief, Office of Merchant Marine
Safety
U. S. Coast Guard Headquarters

Mr. T. W. Pross
Associate Administrator for
Shipbuilding, Operations &
Research
Maritime Administration

Mr. P. M. Palermo
Executive Director
Ship Design & Integration
Directorate
Naval Sea Systems Command

Mr. J. B. Gregory
Chief, Technology Assessment
& Research Branch
Minerals Management Service

Mr. W. M. Hannan
Vice President
American Bureau of Shipping

Mr. T. W. Allen
Engineering Officer
Military Sealift Command

CDR D. B. Anderson, U. S. Coast Guard (Secretary)

Allow 1/2 inches
Margin to trim

SHIP STRUCTURE SUBCOMMITTEE

The SHIP STRUCTURE SUBCOMMITTEE acts for the Ship Structure Committee on technical matters by providing technical coordination for the determination of goals and objectives of the program, and by evaluating and interpreting the results in terms of structural design, construction and operation.

U. S. COAST GUARD

CAPT A. E. HENN
CAPT J. R. WALLACE
MR. J. S. SPENCER
MR. R. E. WILLIAMS

MILITARY SEALIFT COMMAND

MR. D. STEIN
MR. T. W. CHAPMAN
MR. A. ATTERMAYER
MR. A. B. STAVOVY

NAVAL SEA SYSTEMS COMMAND

MR. J. B. O'BRIEN (CHAIRMAN)
CDR R. BUBECK
MR. J. E. GAGORIK
MR. A. H. ENGLE
MR. S. G. ARNTSON (COTR)
MR. G. WOODS (COTR)

AMERICAN BUREAU OF SHIPPING

DR. D. LIU
MR. I. L. STERN
MR. B. NADALIN

MINERALS MANAGEMENT SERVICE

MR. R. GIANGERELLI
MR. R. C. E. SMITH

MARITIME ADMINISTRATION

MR. F. SEIBOLD
MR. N. O. HAMMER
DR. W. M. MACLEAN
MR. M. W. TOUMA

INTERNATIONAL SHIP STRUCTURES CONGRESS

MR. S. G. STIANSEN - LIAISON

AMERICAN IRON & STEEL INSTITUTE

MR. J. J. SCHMIDT - LIAISON

NATIONAL ACADEMY OF SCIENCES
COMMITTEE ON MARINE STRUCTURES

MR. A. DUDLEY HAFF - LIAISON
MR. R. W. RUMKE - LIAISON

STATE UNIVERSITY OF NY MARITIME COLLEGE

DR. W. R. PORTER - LIAISON

SOCIETY OF NAVAL ARCHITECTS &
MARINE ENGINEERS

MR. N. O. HAMMER - LIAISON
MR. F. SELLARS - LIAISON

U.S. COAST GUARD ACADEMY

LT J. TUTTLE - LIAISON

WELDING RESEARCH COUNCIL

DR. G. W. OYLER - LIAISON

U.S. NAVAL ACADEMY

DR. R. BHATTACHARYYA - LIAISON

U.S. MERCHANT MARINE ACADEMY

DR. C. B. KIM - LIAISON

S/S

486-328

Cov. 2

Handwritten initials and a circled number 2.

1/2" To BIND

Committee on Marine Structures
Marine Board
National Academy of Sciences - National Research Council

The Committee on Marine Structures has technical cognizance of the Interagency Ship Structure Committee's research program.

- Mr. A. D. Haff, Chairman, Annapolis, MD
- Prof. A. H.-S. Ang, University of Illinois, Champaign, IL
- Dr. K. A. Blenkarn, Amoco Production Company, Tulsa, OK
- Mrs. Margaret Ochi, Gainesville, PA
- Mr. D. Price, National Oceanic and Atmospheric Administration, Rockville, MD
- Mr. D. A. Sarno, ARMCO Inc., Middletown, OH
- Mr. J. E. Steele, Naval Architect, Quakertown, PA
- Mr. R. W. Rumke, Executive Secretary, Committee on Marine Structures

MATERIALS ADVISORY GROUP

The Materials Advisory Group prepared the project prospectus.

- Mr. D. A. Sarno, Chairman, ARMCO Inc., Middletown, OH
- Dr. R. Bicchichi, Sun Tech. Inc., Chester, PA
- Dr. C. M. Fortunko, National Bureau of Standards, Boulder, CO
- Prof. G. T. Hahn, Vanderbilt University, Nashville, TN
- Dr. N. Zettlemyer, Exxon Production Research Company, Houston, TX

PROJECT ADVISORY COMMITTEE

The Project Advisory Committee provided the liaison technical guidance, and reviewed the project with the investigator.

- Dr. J. E. Goldberg, Chairman, National Science Foundation, Washington, DC
- Prof. Z. P. Bazant, Northwestern Univ., Evanston, IL
- Prof. J. E. Breen, University of Texas, Austin, TX
- Prof. N. M. Hawkins, University of Washington, Seattle, WA
- Dr. B. J. Watt, Brian Watt Associates, Inc., Houston, TX

1" To BIND

75

486-3280 Cov. 3

3

1/2" TO TRIM

SHIP STRUCTURE COMMITTEE PUBLICATIONS

- SSC-316 Ship Structure Committee Long-Range Research Plan: Guidelines for Program Development by E.M. MacCutcheon, O.H. Oakley and R.D. Stout, 1983, AD-A140275
- SSC-317 Determination of Strain Rates in Ship Hull Structures: A Feasibility Study by J. G. Giannotti and K. A. Stambaugh, 1984
- SSC-318 Fatigue Characterization of Fabricated Ship Details for Design by W. H. Munse, T. W. Wilbur, M. L. Tellalian, K. Nicoll and K. Wilson, 1983, AD-A140338
- SSC-319 Development of A Plan to Obtain In-Service Still-Water Bending Moment Information for Statistical Characterization by J. W. Boylston and K. A. Stambaugh, 1984
- SSC-320 A Study of Extreme Waves and Their Effects on Ship Structures by W. H. Buckley, 1983, AD-A140317
- SSC-321 Survey of Experience Using Reinforced Concrete in Floating Marine Structures by O.H. Burnside and D.J. Pomeroy, 1984
- SSC-322 Analysis and Assessment of Major Uncertainties Associated With Ship Hull Ultimate Failure by P. Kaplan, M. Benatar, J. Bentson and T.A. Achtarides, 1984
- SSC-323 Updating of Fillet Weld Strength Parameters for Commercial Shipbuilding by R.P. Krumpfen, Jr., and C.R. Jordan, 1984
- SSC-324 Analytical Techniques for Predicting Grounded Ship Response by J.D. Porricelli and J.H. Boyd, 1984
- SSC-325 Correlation of Theoretical and Measured Hydrodynamic Pressures for the SL-7 Containership and the Great Lakes Bulk Carrier S. J. Cort by H.H. Chen, Y.S. Shin & I.S. Aulakh, 1984
- SSC-326 Long-Term Corrosion Fatigue of Welded Marine Steels by O.H. Burnside, S.J. Hudak, E. Oelkers, K. Chan, and R.J. Dexter, 1984
- None Ship Structure Committee Publications - A Special Bibliography, AD-A140339

3/4" TO TRIM

S/S

486-328

COV. 4

[Faint handwritten scribbles]

[Handwritten initials]