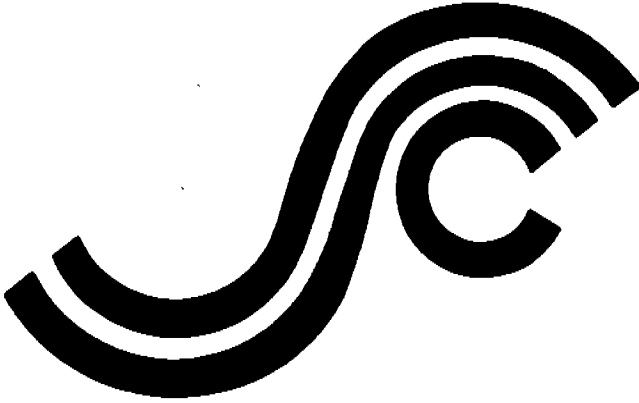


46626 C1

**SSC-365**

**MARINE STRUCTURAL  
INTEGRITY PROGRAMS  
(MSIP)**



This document has been approved  
for public release and sale; its  
distribution is unlimited

**SHIP STRUCTURE COMMITTEE**

**1992**

4662602

SHIP STRUCTURE COMMITTEE

The SHIP STRUCTURE COMMITTEE is constituted to prosecute a research program to improve the hull structures of ships and other marine structures by an extension of knowledge pertaining to design, materials, and methods of construction.

RADM A. E. Henn, USCG, (Chairman)  
Chief, Office of Marine Safety, Security  
and Environmental Protection  
U. S. Coast Guard

Mr. H. T. Haller  
Associate Administrator for Ship-  
building and Ship Operations  
Maritime Administration

Mr. Alexander Malakhoff  
Director, Structural Integrity  
Subgroup (SEA 55Y)  
Naval Sea Systems Command

Mr. Thomas W. Allen  
Engineering Officer (N7)  
Military Sealift Command

Dr. Donald Liu  
Senior Vice President  
American Bureau of Shipping

CDR Michael K. Parmelee, USCG,  
Executive Director  
Ship Structure Committee  
U. S. Coast Guard

CONTRACTING OFFICER TECHNICAL REPRESENTATIVE

Mr. William J. Siekierka  
SEA 55Y3  
Naval Sea Systems Command

SHIP STRUCTURE SUBCOMMITTEE

The SHIP STRUCTURE SUBCOMMITTEE acts for the Ship Structure Committee on technical matters by providing technical coordination for determining the goals and objectives of the program and by evaluating and interpreting the results in terms of structural design, construction, and operation.

AMERICAN BUREAU OF SHIPPING

Mr. Stephen G. Arntson (Chairman)  
Mr. John F. Conlon  
Dr. John S. Spencer  
Mr. Glenn M. Ashe

NAVAL SEA SYSTEMS COMMAND

Dr. Robert A. Sielski  
Mr. Charles L. Null  
Mr. W. Thomas Packard  
Mr. Allen H. Engle

MILITARY SEALIFT COMMAND

Mr. Robert E. Van Jones  
Mr. Rickard A. Anderson  
Mr. Michael W. Touma  
Mr. Jeffery E. Beach

MARITIME ADMINISTRATION

Mr. Frederick Seibold  
Mr. Norman O. Hammer  
Mr. Chao H. Lin  
Dr. Walter M. Maclean

U. S. COAST GUARD

CAPT T. E. Thompson  
CDR Mark E. Noll  
Mr. H. Paul Cojeen

SHIP STRUCTURE SUBCOMMITTEE LIAISON MEMBERS

U. S. COAST GUARD ACADEMY

LCDR Bruce R. Mustain

NATIONAL ACADEMY OF SCIENCES -  
MARINE BOARD

Mr. Alexander B. Stavovy

U. S. MERCHANT MARINE ACADEMY

Dr. C. B. Kim

NATIONAL ACADEMY OF SCIENCES -  
COMMITTEE ON MARINE STRUCTURES

Mr. Peter M. Palermo

U. S. NAVAL ACADEMY

Dr. Ramswar Bhattacharyya

SOCIETY OF NAVAL ARCHITECTS AND  
MARINE ENGINEERS -  
HYDRODYNAMICS COMMITTEE

STATE UNIVERSITY OF NEW YORK  
MARITIME COLLEGE

Dr. W. R. Porter

Dr. William Sandberg

WELDING RESEARCH COUNCIL

AMERICAN IRON AND STEEL INSTITUTE

Dr. Martin Prager

Mr. Alexander D. Wilson

46626 spine

**SSC-365 Marine Structural Integrity Program (MSIP) Ship Structure Committee 1992**

11

43005

Member Agencies:

United States Coast Guard  
Naval Sea Systems Command  
Maritime Administration  
American Bureau of Shipping  
Military Sealift Command



Address Correspondence to:

Executive Director  
Ship Structure Committee  
U. S. Coast Guard (G-MI/R)  
2100 Second Street, S.W.  
Washington, D.C. 20593-0001  
PH: (202) 267-0003  
FAX: (202) 267-4839

An Interagency Advisory Committee

January 10, 1992

SSC-365  
SR-1332

MARINE STRUCTURAL INTEGRITY PROGRAMS

This report presents a procedure for the development of Marine Structural Integrity Programs (MSIP) for commercial ships, with a particular focus given to oil tankers and crude oil carriers. The MSIP procedure suggests a sequence of actions to be performed by the various parties involved in the life cycle (design, construction, operation, inspection, and maintenance) of ships in order to better ensure the integrity of structures during their useful lifetime. The MSIP procedures address organizational and technical considerations.

The MSIP procedure is based on developments from the U.S. Air Force and the Federal Aviation Administration Airframe Structural Integrity Programs (ASIP). In addition, the MSIP procedure is based on recent experience of the shipping industry in the development and implementation of MSIP. Present ship and airframe structures and their associated integrity management programs differ in several important respects. The MSIP procedure developed during this project has attempted to make appropriate and practical applications of the developments from ASIP.

A. E. HENN  
Rear Admiral, U.S. Coast Guard  
Chairman, Ship Structure Committee

1. Report No. SSC-365		2. Government Accession No.		3. Recipient's Catalog No.	
4. Title and Subtitle Marine Structural Integrity Programs (MSIP)				5. Report Date October 1991	
				6. Performing Organization Code	
7. Author(s) Robert G. Bea				8. Performing Organization Report No. SR-1332	
9. Performing Organization Name and Address Department of Naval Architecture University of California Berkeley, CA 94720				10. Work Unit No. (TRAVIS)	
				11. Contract or Grant No. DTCG23-89-C-20032	
12. Sponsoring Agency Name and Address Commandant (G-M) U.S. Coast Guard 2100 Second Street, SW Washington, DC 20593				13. Type of Report and Period Covered Final Report	
				14. Sponsoring Agency Code G-M	
15. Supplementary Notes  Sponsored by the Ship Structure Committee and its member agencies.					
16. Abstract <p>This report addresses development of advanced Marine Structural Integrity Programs (MSIP) for VLCCs and ULCCS. Airframe Structural Integrity Programs (ASIP) for commercial and military aircraft were reviewed as part of this study and provided a basis for the advanced MSIP described in this report. The practicality of implementing advanced MSIP within this industry was given heavy emphasis in this study. Both technical and organizational developments are addressed. The study concludes that advanced MSIP are presently within the grasp of this industry. Key technical developments that are needed to allow advanced MSIP to become a reality include improvements in structural design (corrosion and fatigue durability), inspections, maintenance and repairs, and information systems (life-cycle, industry wide). Key organizational developments that are needed to allow advanced MSIP to become a reality include sufficient allocation of resources (money, manpower), clarifications of MSIP goals and responsibilities, creation of high reliability organizations, and creation of industry-wide information and communications systems. Chapters in this report include 1) Introduction, 2) Airframe Structural Integrity Program, 3) Marine Structural Integrity Program, 4) Structural Design, 5) Inspection, Maintenance and Repair, 6) Information Systems, 7) Evaluation of Alternatives, and 8) Future Development.</p>					
17. Key Words Inspection, Maintenance and Repair Programs Structural Integrity Structural Design			18. Distribution Statement Available from: Nat'l Technical Information Service Springfield, VA 22161 or Marine Tech. Information Facility National Maritime Research Center Kings Point, NY 10024-1699		
19. Security Classif. (of this report) Unclassified		20. Security Classif. (of this page) Unclassified		21. No. of Pages 218	22. Price

## METRIC CONVERSION FACTORS

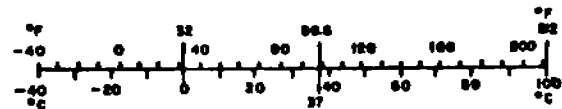
### Approximate Conversions to Metric Measures

Symbol	When You Know	Multiply by	To Find	Symbol
<b>LENGTH</b>				
in	inches	2.5	centimeters	cm
ft	feet	30	centimeters	cm
yd	yards	0.9	meters	m
mi	miles	1.6	kilometers	km
<b>AREA</b>				
in <sup>2</sup>	square inches	6.5	square centimeters	cm <sup>2</sup>
ft <sup>2</sup>	square feet	0.09	square meters	m <sup>2</sup>
yd <sup>2</sup>	square yards	0.8	square meters	m <sup>2</sup>
mi <sup>2</sup>	square miles	2.6	square kilometers	km <sup>2</sup>
	acres	0.4	hectares	ha
<b>MASS (weight)</b>				
oz	ounces	28	grams	g
lb	pounds	0.45	kilograms	kg
	short tons (2000 lb)	0.9	tonnes	t
<b>VOLUME</b>				
teaspoon	teaspoons	5	milliliters	ml
Tablespoon	tablespoons	15	milliliters	ml
fl oz	fluid ounces	30	milliliters	ml
c	cups	0.24	liters	l
pt	pints	0.47	liters	l
qt	quarts	0.95	liters	l
gal	gallons	3.8	liters	l
ft <sup>3</sup>	cubic feet	0.03	cubic meters	m <sup>3</sup>
yd <sup>3</sup>	cubic yards	0.76	cubic meters	m <sup>3</sup>
<b>TEMPERATURE (exact)</b>				
°F	Fahrenheit temperature	5/9 (after subtracting 32)	Celsius temperature	°C

\* 1 in = 2.54 (exactly). For other exact conversions and more detailed tables, see NBS Spec. Publ. 260, Units of Weight and Measure, Price \$2.25, SD Catalog No. C13.10-260.

### Approximate Conversions from Metric Measures

Symbol	When You Know	Multiply by	To Find	Symbol
<b>LENGTH</b>				
mm	millimeters	0.04	inches	in
cm	centimeters	0.4	inches	in
m	meters	3.3	feet	ft
km	kilometers	0.6	miles	mi
<b>AREA</b>				
cm <sup>2</sup>	square centimeters	0.16	square inches	in <sup>2</sup>
m <sup>2</sup>	square meters	1.2	square yards	yd <sup>2</sup>
km <sup>2</sup>	square kilometers	0.4	square miles	mi <sup>2</sup>
ha	hectares (10,000 m <sup>2</sup> )	2.5	acres	
<b>MASS (weight)</b>				
g	grams	0.035	ounces	oz
kg	kilograms	2.2	pounds	lb
t	tonnes (1000 kg)	1.1	short tons	
<b>VOLUME</b>				
ml	milliliters	0.03	fluid ounces	fl oz
l	liters	1.1	pints	pt
l	liters	1.06	quarts	qt
l	liters	0.26	gallons	gal
m <sup>3</sup>	cubic meters	36	cubic feet	ft <sup>3</sup>
m <sup>3</sup>	cubic meters	1.3	cubic yards	yd <sup>3</sup>
<b>TEMPERATURE (exact)</b>				
°C	Celsius temperature	9/5 (then add 32)	Fahrenheit temperature	°F



---

---

**CONTENTS**

---

---

<b>Chapter 1 - INTRODUCTION.....</b>	<b>1</b>
Objective .....	1
Background .....	1
Scope of Work.....	2
Approach.....	3
Perspectives .....	4
ASIP Applications to Advanced MSIP.....	7
Summary .....	8
Acknowledgements.....	9
References .....	10
<b>Chapter 2 - AIRFRAME STRUCTURAL INTEGRITY PROGRAMS.....</b>	<b>13</b>
Background .....	13
Organizational Aspects.....	13
Technical Aspects.....	14
Organizational Systems.....	15
Information and Communications Systems.....	19
Technical Systems .....	20
Continuing Developments.....	28
References .....	29
<b>Chapter 3 - MARINE STRUCTURAL INTEGRITY PROGRAMS.....</b>	<b>45</b>
Background .....	45
Recent Developments .....	46
ASIP Applications to MSIP.....	55
Advanced MSIP.....	56
Technical Developments.....	57
Organizational Developments .....	72
Research and Development.....	75
Summary .....	76
References .....	77
<b>Chapter 4 - STRUCTURAL DESIGN.....</b>	<b>101</b>
Background .....	101
Corrosion Durability Design.....	101
Fatigue Durability Design.....	106
Design for Inspections, Construction, and Damage Tolerance .....	116

<b>Chapter 5 - INSPECTIONS, MAINTENANCE, REPAIRS.....</b>	<b>131</b>
Background.....	131
Precepts of IMR .....	132
Inspections.....	134
Maintenance & Repairs .....	142
Summary.....	146
References.....	146
<b>Chapter 6 - INFORMATION SYSTEMS .....</b>	<b>157</b>
Introduction.....	157
Technical Aspects.....	158
Organizational Aspects.....	164
Summary.....	165
References.....	165
<b>Chapter 7 - EVALUATIONS OF ALTERNATIVES.....</b>	<b>173</b>
Introduction.....	173
Approaches.....	174
Economics Based Approach.....	175
Historic Performance Based Approach.....	183
Evaluation of Fatigue & Corrosion Durability Alternatives .....	186
Summary.....	191
References.....	192
<b>Chapter 8 - FUTURE DEVELOPMENTS.....</b>	<b>207</b>
Background.....	207
Structural Design.....	207
Inspections, Maintenance, Repairs.....	209
Information Systems .....	210
Summary.....	211



# Chapter 1

## INTRODUCTION

### **Objective**

---

**The objective of this study was to develop a procedure for definition of advanced marine structural integrity programs (MSIP) for commercial (non-military) ships that would include more efficient inspection, more economical and safer operation, and more effective maintenance.**

The MSIP procedure was to suggest a sequence of actions to be performed by the various parties involved in the life cycle (design, construction, operation, and maintenance) of ships in order to better ensure the integrity of the structures during their useful lifetimes.

**In particular, this project was intended to address development of advanced MSIP for commercial ships, with a focus on large crude carriers (tankers). This was in response to the many recent political and environmental concerns relative to crude oil tankers.**

**Notwithstanding this focus on large crude carriers, it is felt that the MSIP procedure discussed herein will be applicable to most commercial ships with few modifications.**

### **Background**

---

At the Ship Structure Committee sponsored Symposium on the Design, Inspection, and Reliability Triangle (DIRT) [1.1], the U.S. Air Force and Federal Aviation Administration (FAA) Airframe Structural Integrity Programs (ASIP) were described. The descriptions included ASIP development, overall strategy, and important experiences. Participants at the conference were enthusiastic about the prospects of adopting ASIP concepts to the marine industry [1.2].

Important components of the ASIP consisted of:

(a) **Material selection,**

- (b) Identification of critical components and potential failure modes,**
- (c) Durability and damage tolerance analysis,**
- (d) Full-scale testing of critical components,**
- (e) Inspection strategy,**
- (f) Tracking programs of individual structures,**
- (g) Record keeping of structural maintenance, and**
- (h) Management of aging structures.**

Technology transfer from the aerospace to the marine industry appeared to be timely and particularly relevant in view of many common design, operation, performance, and maintenance requirements of airframes and ships.

## **Scope of Work**

---

The scope of work for this project was defined as examining the sequence of actions to be performed by the various parties involved in the life cycle (design, construction, operation, and maintenance) of commercial ships in order to ensure the integrity of their structures during their useful lifetimes.

The results of this project were to include:

- 1) General definition of the elements of the life cycle that should be considered in marine structural integrity programs;
- 2) Definition of an information system that could be used as a basis for developing MSIP consistent with the needs of all interested parties;
- 3) Description of how to evaluate the cost effectiveness of the various structural design strategies, including tradeoffs with such design issues as material selection, redundancy, and reserve strength;
- 4) Development of a technical basis for preparing inspection and maintenance strategies for maintaining structural adequacy with minimum cost for repair and replacements; and
- 5) Recommendation of procedures, and if necessary, future research topics for the implementation of MSIP for ships.

---

## Approach

---

The scope of work in this project was performed by convening several interdisciplinary groups to examine the problems and opportunities for technology transfer among the various sectors working with the management of ageing marine structures; including harbor and coastal structures, offshore platforms and pipelines, and ships.

A series of national and international meetings were held with key individuals to discuss the problems and opportunities for technology transfer in adapting structural integrity management methods from the ASIP, and similar programs from other industries.

One of these meetings was titled **Preservation of Ageing Marine Structures** [1.3]. During this meeting, leaders from four sectors of the marine industry presented their programs for life-cycle management of structural integrity (harbor, coastal, offshore, and ship structures). Two advanced commercial ship (container, VLCC) MSIP systems were described and discussed during this symposium.

A second meeting that had major implications for this study was titled **Marine Structural Inspection, Maintenance, and Monitoring Symposium** [1.4]. This meeting brought together an international group of ship owners, operators, builders, researchers, government agencies, and classification societies to discuss recent developments in marine structural integrity programs.

A number of field trips were made by the author to ship construction and repair yards to observe problems associated with ship structural maintenance. The author participated in several ship inspections, classification surveys, and unscheduled repair operations to observe the challenges associated with determining the structural condition and integrity of ship structures, and given the detection of important defects or damage, the challenges of making adequate repairs.

In addition, the author participated in a maintenance, inspection, modification and repair operations tour of the United Air Lines Maintenance Operations Center in San Francisco. This center has over 11,000 employees and does work on more than 1,200 airframes each year. The tour involved inspections of the structural airframe of a 747, and observations of repair and modification operations on a 727.

The personal experiences associated with the very different, yet very similar ship and air structure systems served to focus many of the practical aspects of applications of ASIP to advanced MSIP.

The last source of information utilized in this study was published literature pertaining to recent developments in:

- a) Military and commercial ASIP;
- b) Commercial ship MSIP;
- c) Structural integrity programs for offshore platforms and harbor-coastal structures; and
- d) Structural integrity programs for other systems such as dams, bridges, nuclear power plants, pipelines, and machinery.

### Perspectives

---

Ship structure integrity programs have been in existence for as long as there have been ships. These programs have been based on experience. If the ship structure was not adequate, it was changed until it was serviceable, or the type of service demanded of the ship was changed.

If the ship was not adequately maintained, it rapidly degraded in the marine environment, and it was scrapped and replaced by another ship. If something in the ship structure failed, it was temporarily or permanently repaired. If the repair was good, it lasted until the ship was scrapped; if not, the repair was repeated.

The history of ship design, construction, operation, and maintenance has been one of generally slow evolutionary change. The culmination of this evolution is represented by current ship structure classification society guidelines. These guidelines have been developing over the last one hundred years, with concentrated development since the 1940's. Application of these guidelines through the infrastructure of the maritime industry has resulted in the present world-wide fleet of commercial ships.

The evolution of the classification society guidelines are paralleled by a similar evolution of regulatory requirements and procedures, naval architecture technology and procedures, ship building technology and procedures, and ship operations and maintenance technology and procedures.

These developments have evolved in the context of a loosely organized multiplicity of world-wide organizations that design, construct, operate, maintain, and regulate commercial ships.

Given this historical perspective, what is the motivation for change in MSIP? This study suggests that there are several strong motivations. The first is a general feeling that **ship structural integrity programs can be improved**. Technology and experience exists for such improvements. ASIP provides one basis for evaluating potential technology improvements.

The second is a general feeling that **ship structural integrity programs must be improved**. Requirements for more economical and reliable ship operations are rapidly escalating. Ship structural maintenance and inspection are not in an advanced stage of development. Economic costs associated with scheduled and unscheduled repairs and and economic, political, and environmental costs of major casualties have increased dramatically.

*It is important to recognize that the vast majority of ship casualties are not primarily related to structural causes (Fig. 1.1). Machinery, equipment, and piping problems coupled with operations (human, organization) related problems, account for the majority of major ship casualties. Less than 10 percent of major ship casualties can be traced directly to structural integrity problems.*

Similarly, it is important to recognize that the **vast majority of ship structure problems are associated with durability and maintenance**. Management of corrosion and fatigue cracking in critical structural elements has proven to be a primary challenge. Thus, **the primary motivation for improvements in ship structural maintenance programs is fundamentally economic, recognizing that the economics must address both initial or first costs, and long-term operations and maintenance costs.**

**Present experience indicates that the primary structure related problems with the current generation of crude carriers are centered in corrosion and fatigue - corrosion cracking.** A majority of fatigue cracking problems can be traced to inappropriate design, construction, and operations (driving the ships too hard).

A majority of corrosion problems can be traced to a complete lack of coatings in ballast tanks and poor design of coating and cathodic protection systems, improper surface preparation and application, and poor corrosion system maintenance. Many of the problems associated with lack of sufficiently durable coatings can be traced to the buyer of a new ship compromising on the extent, quality and thickness of coatings due to budgetary constraints. Coatings are one of the high-cost items of a new ship that are not immediately essential to the operation of the vessel. New ships always cost more than an owner originally expected and budgeted for; thus durable coatings become a convenient target for cut-backs. The owner realizes that this decision will have economic consequences down the road, but today is today, tomorrow is another day, and the ship must be delivered on time and on budget.

**There seems to have been a dramatic change in the general state of affairs concerning the critical structural systems in these ships in the last 20 years.** Due to economic pressures, manpower and experience have been significantly reduced. This has resulted in reductions in the extent and intensity of design, inspection, quality assurance, and maintenance. At the same time, there has been a rapid increase in the size and complexity of

modern ships. In the past, extra structure in the ship was included to compensate for the shortcomings of the crude analytical tools available. Modern computer based analyses and the accompanying structural refinements have lead to significant reductions in structural durability and robustness.

Experience based design rules seem to have been extrapolated beyond their intended ranges. The size of the ships has increased dramatically in a relatively short period of time. Advanced design and engineering technology has been very slowly adopted. Higher strength steels have been used to reduce steel weight (and hence the cost of a new ship), but at a sacrifice in durability.

The influence of rule development on the mid-ship section modulus for tankers (minimum requirement) and shear area for a ship length of 200 m (Fig. 1.2) indicates that the current minimum section modulus is two-thirds and the shear area one-half of their values in the 1950's [1.1]. The overall steel weight (Fig. 1.3) has decreased to 50 to 60 percent of its 1950's value [1.1]. Structure durability and robustness have been sacrificed in the process.

Incompatibilities in corrosion protection coatings and measures (e.g. not repairing coating breakdown areas, not replacing anodes) and the ship structure (flexure of major components resulting in breakdown of stiff coatings), and operations (driving the ships hard on frequently traveled severe weather routes) have provided unanticipated structural problems.

The basic design of the crude carriers has changed to meet the change in cargo, ballast, and safety requirements. The basic design of ships also has changed to meet the changes in the competitive, operating, and economic - financial environments. The average weight to volume ratio of the ships has dropped in response to the demands for lower initial costs resulting from highly competitive bidding.

Due to much higher prices of new building and the long delivery times, there is a need to keep ships in service for much longer periods of time. In many cases, quality in designing, new building and maintenance have been sacrificed to lower initial and maintenance costs. Requirements on ship durability and reliability have changed.

ASIP for commercial and military airframes are principally the product of the last three to four decades of very rapid and intense technology and organizational developments. Because of the importance of public transport safety and the very demanding requirements of high performance jet powered aircraft, significant attention has been given to the technological and organizational aspects of airframe reliability.

Formal ASIP developments were initiated in the 1950's with the introduction of jet powered commercial aircraft. In the mid 1970's, there was

a major overhaul of ASIP policies for both military and commercial aircraft. This overhaul was in direct reaction to serious structural problems which were encountered in several new airframe structural systems, as well as fatigue cracking and corrosion problems in older in-service aircraft. A critical re-examination was made of the process of aircraft development, procurement, and management. New regulations, design, operation, and maintenance guidelines, and certification requirements were developed that are still in force today.

However, ASIP are still developing. Due principally to ageing problems associated with the commercial fleet, and new more demanding requirements for high performance military aircraft, ASIP research and development continues to be intensely conducted throughout the aircraft industry.

A very advanced technology and cooperative organization system for ASIP has been the product of this evolution. Regulatory, manufacturing, and operations-maintenance segments of this industry, and the general public have shared in the costs and benefits of this development.

It is important to recognize that **ASIP are one of three related and coordinated efforts to achieve serviceability, economy, durability and reliability of aircraft.** In development of ASIP, **balanced emphasis has been given to the structural, mechanical (avionics), and operational (human, organization) aspects.**

In many ways, current (1991) developments regarding structural systems for commercial ships parallel the earlier developments regarding the same systems for jet powered commercial and military aircraft. Current experience suggests that a similar overhaul of the processes of structural system design and development, procurement, and management is needed for some ship structures. Development of advanced MSIP have been initiated in Europe. This perspective suggests significant technical and operational challenges for the U.S. marine industry if advanced MSIP are to become a reality for the next generation of commercial ships.

## **ASIP Applications to Advanced MSIP**

As indicated by the results of the DIRT symposium, there is some enthusiasm on the part of the marine industry to adopt aspects of ASIP into development of advanced MSIP. A key element of adaptation and implementation of ASIP developments is **practicality**. Practicality is taken to include the following attributes:

- **Simplicity** (ease of use and implementation),
- **Versatility** (ability to handle a variety of real problems),

- **Compatibility** (readily integrated into present engineering and operations procedures),
- **Workability** (data required is available or economically attainable, output is understandable and can be effectively communicated),
- **Feasibility** (engineering, inspection, and maintenance tools and techniques are available for application), and
- **Consistency** (the approach can produce similar results for similar problems when used by different people).

The attribute of practicality is very important as one examines potential applications of ASIP to MSIP. There are major differences between airplanes and ships. There are even more significant differences in the regulatory-corporate cultures that underlie these two systems.

An important component of this practicality are the motivations for changing from traditional MSIP to advanced MSIP. Here again, good judgement is critical. For ship owners and operators, regulators, and builders to change from what they are now doing, they must be convinced that what they will change to really represents a needed and warranted improvement. All of these parties must be provided with positive incentives for adopting advanced MSIP. **Commitment and the necessary resources (money, manpower, knowledge, time) are required if advanced MSIP are to become reality.**

A second important consideration is **the degree of development and application of advanced MSIP**. Advanced MSIP should be applied to ship structures that warrant such systems. The degree of development and application should be in proportion to the problems that the MSIP is intended to help solve.

**A fundamental objective of an advanced MSIP is to improve the serviceability - durability, reliability and economy (initial and long-term) of critical ship structure systems. A balance must be achieved between the costs to improve serviceability - durability and reliability, and the benefits of these investments.**

---

## Summary

---

There are three basic aspects of an advanced MSIP (Fig. 1.3). These are high quality:

- 1) Design,



2) Construction, and

3) Maintenance.

**The primary objective of an advanced MSIP is to result in a ship structure that will have adequate (acceptable) strength, robustness (damage tolerance), durability, and reliability. MSIP must be disciplined and vigilant throughout the life cycle of the ship.**

**There are two important factors that should be addressed in developing an advanced MSIP. These are:**

1) Technical factors, and

2) Organizational factors.

**Technical factors include those engineering, construction, and maintenance guidelines and procedures that should be followed to achieve the desired MSIP objectives. In most cases, the technology is available. In some cases (e.g. military vessels), much of this technology has been and is being used. The primary problem is identifying how best to adapt this technology to an advanced MSIP for commercial ships, and then implementing this technology in the context of the culture and organization of this sector of the marine industries. It is here that the objective of "practicality" receives its greatest tests.**

**Organizational factors include those elements of planning, organizing, leading, and controlling the activities of the primary governmental and industrial sectors that comprise the tanker industry. A major challenge is organizational, changing existing MSIP organizational and "corporate culture" aspects to be able to implement advanced MSIP. A positive incentive system needs to be provided to encourage cooperative industry-wide development and implementation of an advanced MSIP system.**

**The "core" of advanced MSIP is a structured and effective MSIP information system (Fig. 1.3). This information system provides the basis for recording, archiving, analyzing, evaluating, and disseminating information that is developed during MSIP. It is the core that binds the organizational and technical aspects of an advanced MSIP.**

---

**Acknowledgements**

---

The author wishes to express his appreciation to those individuals who have made significant contributions to the preparation of this report. The contributions of Howard Wood (Airframe Structural Integrity Program, Wright-Patterson Air Force Base), Tom Swift and Douglas

Sharman ( Airframe Section, Federal Aviation Agency), Charles Bookman (Marine Board, National Academy of Engineering), Paul Cojeen, Jack Spencer, and John Baxter (U.S. Coast Guard), John Conlon, Y. K. Chen, and Anil Thayamballi (American Bureau of Shipping), John Ferguson (Lloyd's Register of Shipping), Tom Hagner and Dick Bell (Amoco Ocean Tanker Co.), Dick Whiteside and Dave Witmer (BP Oil Shipping Co.), Bob Ternus, John Balczewski, and Rong Huang (Chevron Shipping Co.), and Professor Bill Webster (University of California, Berkeley) are gratefully acknowledged. This project would have fallen far short of its goals without the help and advice provided by these individuals.

The author also wishes to acknowledge the Committee on Marine Structures Program Advisory Committee: Paul Cojeen (U. S. Coast Guard), Fred Seibold (Maritime Administration), and Richard Sonnenschein (Maritime Administration), Chairmen; Edward Kadala and Bill Siekierka (NAVSEA), Anil Thayamballi and Y. K. Chen (American Bureau of Shipping), Glenn Ashe (Military Sealift Command), Mike Parmelee (Contract Technical Representative, U.S. Coast Guard), , Tom Brady (David Taylor Research Center), Alex Stavovy (Marine Board, National Research Council), Bernie Stahl (Amoco Production Co.), Dick Bell (Amoco Ocean Tanker Co.), John Balczewski (Chevron Shipping Co.), Jim Lloyd (Exxon Production Research Co.), and Peter Weber (Exxon Shipping Co.) This committee provided essential and timely direction and assistance in all aspects of this project. Again, this project would have fallen far short of its goals without the help and advice provided by these individuals.

Professor Robert Bea  
Department of Naval Architecture & Offshore Engineering  
University of California Berkeley

---

## References

---

- [1.1] Faulkner, D., Shinozuka, M., Fiebrandt, R. R., and Franck, I. C. (1983). *The Role of Design, Inspection, and Redundancy in Marine Structural Reliability*, Committee on Marine Structures, Marine Board, National Research Council, National Academy Press, Washington, D. C..
- [1.2] Committee on Marine Structures (1984). *Toward and Integrated Design, Inspection, and Redundancy Research Program*, National Academy Press, Washington, D. C.
- [1.3] Bea, R. G. (Editor) (1990). *Preservation of Ageing Marine Structures, Proceedings of Sea Grant Symposium*, Univ. of Cal. at Berkeley.
- [1.4] Ship Structure Committee and Society of Naval Architects and Marine Engineers (1991). *Proceedings Marine Structural Inspection, Maintenance, and Monitoring Symposium*, Arlington, Virginia.

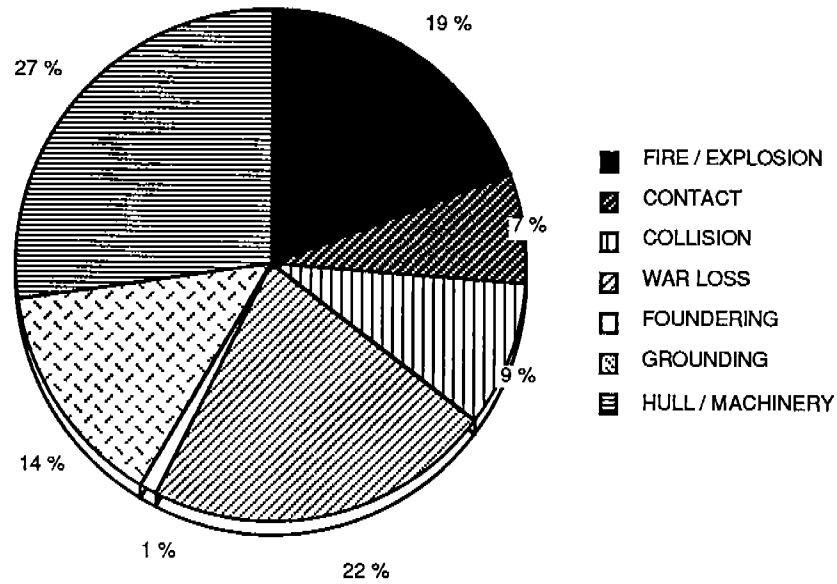


Figure 1.1 - Analysis of Tanker Casualties (Above 10,000 grt), 1979 - 1987

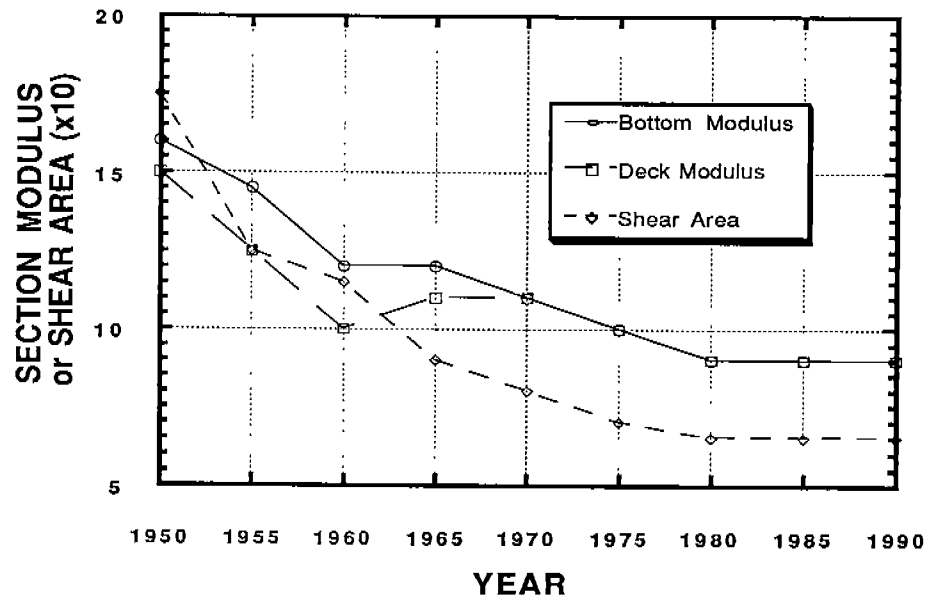
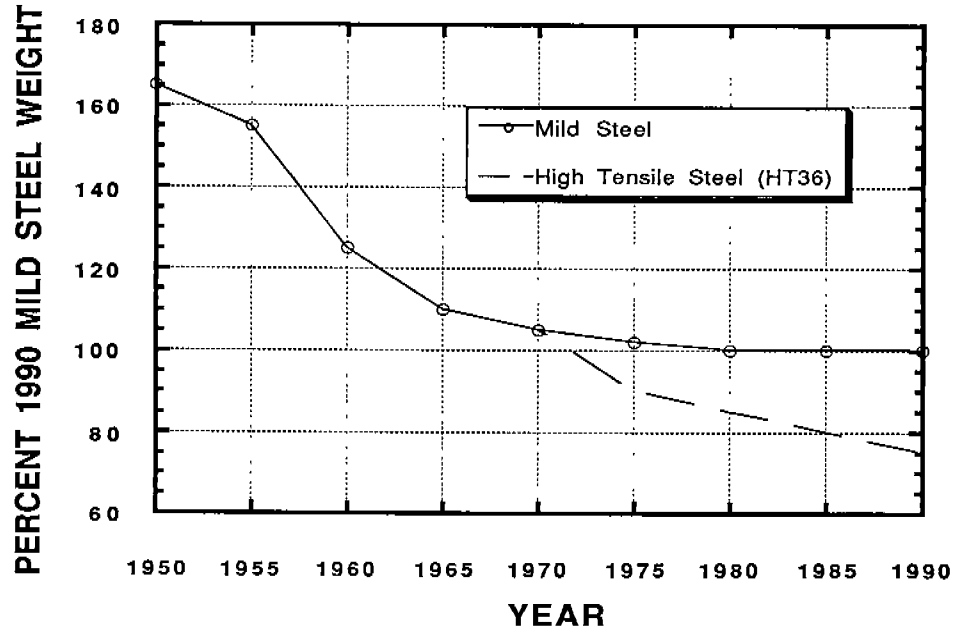
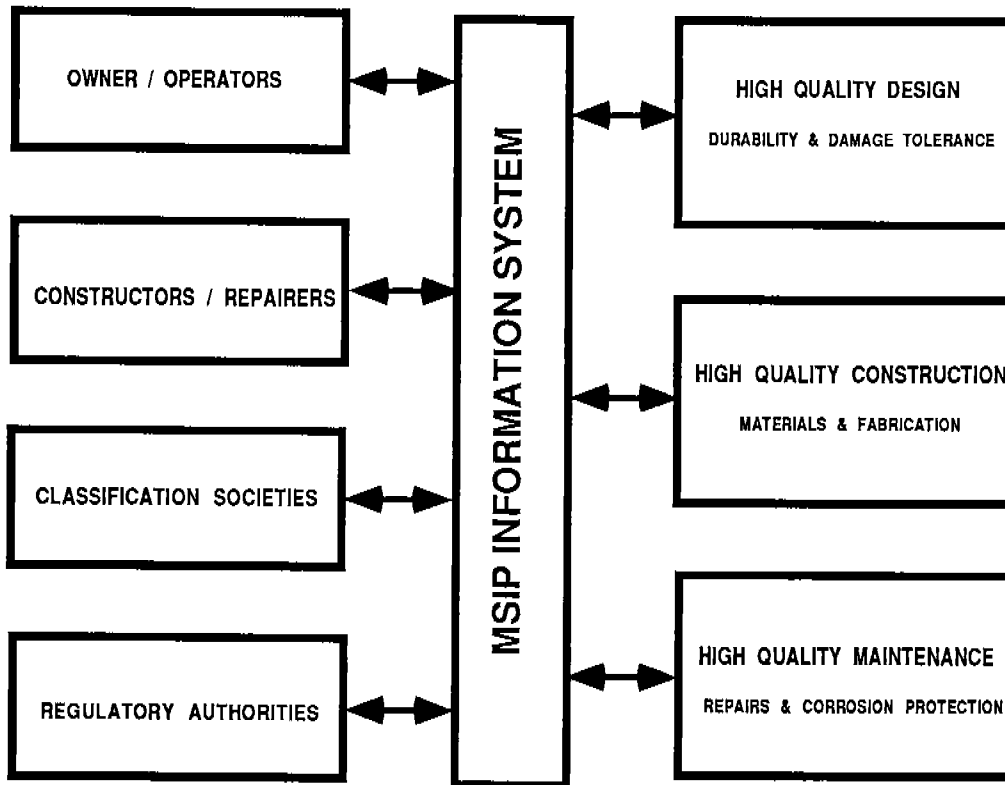


Figure 1.2 - Influence of Rule Development on the Mid-ship Section Modulus and Shear Area for 200 meter VLCCs (Minimum Requirements)



**Figure 1.3 - Influence of Rule Development on the Steel Weight of 200 meter VLCCs (Minimum Requirements) since the 1950's**



**Figure 1.4 - Principal Components of an Advanced MSIP**

# Chapter 2

## AIRFRAME STRUCTURAL INTEGRITY PROGRAMS

### **Background**

---

**The objective of this chapter is to summarize the primary technical and organizational aspects of present Airframe Structural Integrity Programs (ASIP). The purpose of this chapter is to learn how existing ASIP technology can be applied to develop a practical advanced Marine Structural Integrity Program (MSIP)**

There are many similarities and duplications of ASIP for commercial and military aircraft [2.1, 2.2]. ASIP for commercial aircraft are defined by FAA regulations, guidelines, and requirements. The FAA is primarily concerned with safety, and consequently these requirements pertain primarily to safety. Commercial aircraft have a fairly restricted set of performance requirements (fewer route profiles, missions, etc.) in comparison with military aircraft.

ASIP for military aircraft are defined by the various military branch (Air Force, Navy, Army) standards and specifications. The military is not only concerned with safety, but because it also represents the owner and operator, it is concerned with procurement and maintenance costs and long-term durability.

This review has included background on ASIP for both military and commercial aircraft. Because of the important organizational and regulatory aspects unique to commercial aircraft and represented by the FAA, review of the organizational aspects has been restricted to commercial aircraft.

### **Organizational Aspects**

---

In overview, there are two striking aspects of ASIP. **The first is how the industry is organized to conduct ASIP** [2.3]. The organizational aspect is highlighted by highly structured and cooperative national and international frameworks for:

---

## Marine Structural Integrity Programs

---

- a) **Dissemination, archiving, and evaluation of information** (communications); and
- b) **Training, testing, and verifying the capabilities and performance** of design, manufacturing, operations, and maintenance **personnel.**

---

## Technical Aspects

---

The second striking aspect of ASIP are the technical methods and procedures used to assure the integrity of airframes [2.1]. The technical aspect is highlighted by:

- a) Intensive and rapid development and application of advanced technologies, firmly founded on past experience, and justified by a combination of analysis, testing, monitoring (inspection), with **heavy emphasis on testing and monitoring founded on sophisticated and realistic analyses;**
- b) A **comprehensive approach to engineering for and maintenance of reliability and economy;** not only addressing ASIP, but as well, avionics (mechanical, electrical, equipment systems), aviation systems (airports, airways, air traffic control), and personnel performance integrity programs;
- c) Design of aircraft structures that not only address functional and strength (capacity) requirements, but as well, design for damage and defect tolerance; and design for constructability, inspection, and maintainability; heavy emphasis is given to **defect/damage tolerant design and durability design to minimize the risks of low probability high consequence accidents and unanticipated maintenance.**

The ASIP system is not perfect. It is still undergoing intensive development, attempting to make use of current experience and technologies [2.4]. The result of the present ASIP program is an industry service and safety record that represents a standard of comparison for other industries. U.S. designed, manufactured, and operated aircraft are in world-wide demand. In spite of its innovative and high technology profile, and public participation, this is an industry remarkably free of dissipating litigation. This is an industry worth examining to determine how MSIP for U.S. commercial ships might be improved.

## Organizational Systems

The organizational framework of commercial ASIP involves three major segments [2.3-2.5]:

- 1) **Regulatory** - Federal Aviation Administration (FAA),
- 2) **Manufacturing** - designers and manufacturers (three major U.S. aircraft companies and two European companies, and one Japanese company), and
- 3) **Operations** - owners, operators, maintenance facilities ( 30 ± U.S. domestic and international air carriers).

## Responsibilities

Table 2.1 defines the ASIP responsibilities for each of these three segments. The responsibilities can be summarized as:

- a) **The FAA is responsible for the policies and goals for ASIP;**
- b) **The designer / manufacturer is responsible for the airworthiness of the aircraft; and**
- c) **The owner/operator is responsible for the safe and economic operation of the aircraft.**

Each operator can develop an inspection program tailored to his specific needs and capabilities. A group of operators may collaborate with the FAA to develop a basic minimum inspection program for a particular aircraft and route. This activity is carried out by a Maintenance Review Board (MRB). Guidelines for the MRB are developed in advance by a Maintenance Steering Group (MSG). **The MSG guidelines include procedures for rating the relative significance of inspection and maintenance items for a particular aircraft. Particular attention is given to corrosion and corrosion-fatigue because recent service experience indicates that approximately 80-percent of in-service damage results from these causes.**

The FAA conducts its ASIP regulatory responsibilities through three primary functions:

- a) Development and issuance of **technical standards and regulations,**
- b) Performance, evaluation, and reporting results of **design and manufacturing reviews and inspections,** and

---

## **Marine Structural Integrity Programs**

---

### **c) Performance, evaluation, and reporting results of operations and maintenance inspections.**

In this framework, it is important to note that the FAA also operates the Air Traffic Control (ATC) system in the U.S. ATC constitutes the largest segment of FAA staff [2.3].

In a historical context, it is important to note that the three components of this industry have grown up together. The organizational and technical development and evolution have been extremely rapid. **A hallmark of this development has been a general theme of cooperation and trust among the three segments.**

**Economic incentives that promote cooperation have been developed and integrated within the three segments of this vital industry. For example, the detail and frequency of FAA inspections can be moderated for owner/operators that have excellent safety records and for manufacturers that have excellent quality assurance records. Owner/operators require that the airframes be durable, increasing in-service time and decreasing repair time and are willing to pay manufacturers more for high quality aircraft. Manufacturers are held responsible for the quality and durability of their aircraft; their economic incentive is to demonstrate high quality and to sell more aircraft because of the service characteristics of these aircraft.**

The FAA ASIP function employs approximately 3,000 people. Because of the importance of the regulatory function, it will be further detailed in the remainder of this section.

### **Certification Programs**

The FAA functions are discharged through the issuing regulations, procedures, guidelines, and personnel activities associated with **three certification programs** [2.4]:

- 1) Type** - assuring that the manufacturer's design for a particular type of aircraft complies with all statutes and all applicable rules and standards.
- 2) Production** - quality control surveillance to review and approve the manufacturers' procedures and quality control systems, to conduct detailed audits by quality assurance teams, to approve flight test programs and conduct flight tests.
- 3) Airworthiness** - inspections and surveillance of the flight operations and maintenance procedures of the airlines to make sure that each aircraft adheres to the applicable standards of continuing air-



worthiness; to approve maintenance, repair, and overhaul facilities; and to license supervisory mechanics and inspectors.

The FAA has a headquarters central engineering organization that is staffed with personnel of the highest available technical competence and experience. Many of these engineers have worked in the manufacturing and operations sectors of this industry. These personnel are primarily responsible for aircraft type certifications, and national policy and regulations governing production and maintenance of aircraft.

The engineering functions for aircraft design certification policy and regulations are divided among four field offices, called Directorates. These Directorates are strategically located in the vicinity of primary manufacturing locations (Seattle, Kansas City, Fort Worth, Boston). Each Directorate is responsible for implementing the certification programs and issuing of key documents including: a) Airworthiness Directives (instructions for aircraft changes required in response to maintenance and operations experiences); b) Regulatory Changes, c) New Regulations, d) Advisory Circulars, and e) Internal Directives.

The day-to-day work within the geographic area for which each Directorate is responsible is carried out by Aircraft Certification Offices (ACO). The ACO certification programs encompass all categories of products whose manufacturers are located within the ACO geographic area of responsibility.

The FAA-manufacturer-operator organizational framework is highly structured and formal. The formal framework is paralleled by an informal and highly cooperative daily working organization. **The organization is intensely communicative; attempting to maintain accurate and timely dissemination of critical information.**

At its headquarters office, the FAA establishes technical design standards and regulations. In the regional offices, the FAA assures that each new type of aircraft is designed and manufactured in accordance with the rules and standards. The regional office is responsible for the issuance of a design Type Certificate and a Production Certificate. The regional offices also are responsible for reviewing the fabrication of airplanes and for issuing an Airworthiness Certificate for each aircraft. The regional offices employ a system of inspections and surveillance of the flight operations and maintenance procedures used by the owners/operators to ensure that each aircraft adheres to FAA standards of continuing airworthiness. The FAA approves repair and overhaul procedures and stations, and licenses operators, mechanics, and inspectors.

The relationship between the FAA and the designers/manufacturers and owners/operators is one founded on two phrases: **the Applicant must show, and the Administrator finds.** The net effect is that the burden of proof of compliance is placed on the applicant (designer/manufacturer,

---

## **Marine Structural Integrity Programs**

---

owner/operator) for the certificate or approval. The applicant must show the FAA that the design, construction, and operation of the airframe complies with the ASIP.

### **Regulatory Personnel Qualifications**

For the purposes of ASIP, FAA employ engineers, manufacturing inspectors, test pilots, aircraft evaluation pilots, and airworthiness inspectors. Table 2.2 summarizes the types of FAA ASIP employees, their qualifications, and their responsibilities [2.4].

The FAA also employs a cadre (12±) of ASIP engineers that are world-class specialists in technical areas of critical interest to ASIP **(National Resource Specialists). These specialists are on call to assist any of the FAA offices in resolving technical problems. They also assist the designers / manufacturers and operators in identifying and resolving special technical problems.** Several of these specialists were very helpful to the author in sending current technical information on design, manufacturing, and maintenance (inspections, repairs).

About 400 FAA engineers nationwide are concerned with the certification of aircraft. In contrast, a single manufacturer may concentrate 4,000 engineers on a new aircraft. Some 300,000 engineering drawings; 2,000 engineering reports; and 200 vendor reports would result from this effort. FAA engineers cannot review and quality assure such a volume of information; yet the FAA must be certain that the design meets the regulatory requirements.

**The FAA relies heavily on the use of "designees."** Tables 2.3, 2.4, and 2.5 summarize the types of designees, their qualifications, and their responsibilities.

Designees consist of designated engineering representatives (DER), designated manufacturing inspection representatives (DMIR), and designated airworthiness representatives (DAR). In the main, these designees are engineering, operation, and manufacturing specialists who are employees of the airframe manufacturing and owner/operator organizations.

The FAA certification process depends not only on high quality review by FAA engineers, but as well, on the assistance rendered by employees of the aircraft manufacturers - the DERs who review the design, the design process, on behalf of the FAA to make sure that all aspects of the regulations are complied with. **Heavy emphasis is given by the FAA and DERs on compliance with both the letter and the spirit of the regulations, since the regulations cannot cover all foreseeable aspects or developments associated with ASIP.**

The use of designees might suggest serious conflict of interest or designee's maintaining their objectivity. However, some 20 years of industry experience with this approach has shown that these problems are not present in most cases. This is because of four primary steps taken by the FAA in setting up the designee processes:

- a) Designees are chosen who have and are highly motivated to maintain reputations for technical integrity;
- b) Designees are chosen that recognize the stake of the manufacturer and operator in safe operation of the aircraft;
- c) Designees conduct their functions under the supervision of FAA staff; and
- d) Particularly critical approvals are performed by FAA staff.

As required, the FAA organizes expert "teams" to address special technical and organization problems associated with new aircraft, old aircraft, and accidents. These teams are comprised of employees of the FAA, the National Transportation Safety Board (NTSB), the manufacturers, and the owner/operators. The objective is to utilize the best available knowledge and experience to help resolve problems in a way that will balance the interests of the regulatory, manufacturing, and owner/operator organizations.

---

## **Information and Communications Systems**

---

A particularly important part of this organization is the communications and information system operated by the FAA, the aircraft manufacturers, and the owners/operators [2.3, 2.4]. A detailed tracking system is set up for each aircraft from the time it is proposed for design until the aircraft is decommissioned. **This computer based information and data system is established in the first phase of development of the aircraft and further developed through the life-cycle of a particular aircraft.** The system includes an ASIP master plan, structural design criteria, damage tolerance and durability control plans, selection of materials, processes, and joining methods (manufacturing) plan, and design service life and design usage (operations) plan. Individual aircraft are tracked by each of the three segments responsible for that aircraft (FAA, manufacturer, operator).

**Weekly reports** are issued by the FAA to representatives within each of the three segments of the organization (regulatory, manufacturing, operations) on the **problems, results of inspections and repairs, and critical experiences associated with each of these plans. Manufacturers and operators are required to submit daily mechanical reliability reports detailing**

**special manufacturing and operations problems resulting in significant interruptions to these functions.**

**Specialists (Maintenance Analysis Centers, Production Analysis Centers) are assigned to review the reports weekly on given types or classes of aircraft, and as required, issue corrective action directives.** These directives are incorporated into the ASIP reporting system and corrective responses monitored.

The information system is not perfect. Lapses develop among FAA offices, and among the manufacturers, operators and the FAA. To help minimize the lapses, significant efforts have been and are being directed toward comprehensive integration of the system to include the life-cycle ASIP developments (design, manufacture, operation, maintenance) and industry wide ASIP information (FAA, manufacturer, operator).

NASA (National Aeronautics and Space Administration) has developed a computer based Aviation Safety Reporting System (ASRS) for the FAA that includes the standard required reliability reports, and in addition, confidential reports on safety problems and violations of procedures within the aviation system. NASA has operated a similar system since 1975 and it has proven to be extremely important in giving early warning indications of developing safety problems.

---

## **Technical Systems**

---

The fundamental objective of ASIP technical systems **is to minimize the risks of high consequence accidents while maximizing the serviceability and durability of the aircraft** [2.1, 2.5].

This objective is focused in three key technical strategies:

- 1) **Damage Tolerant Design** - design of an airframe that has the ability to tolerate defects, flaws, and damage and is able to maintain the critical aspects of capacity and redundancy.
- 2) **Careful and High Quality Production** - design and manufacturing processes and procedures, and inspection methods that will assure a high quality airframe.
- 3) **Excellent Maintenance** - painstaking attention to inspection, maintenance, and repair/replacement of critical airframe details throughout life to maintain the critical aspects of capacity and redundancy.

ASIP safety requires that strength (capacity) be achieved and maintained [2.6]. High quality production is intended to achieve the mission

strength objectives. Maintenance is intended to validate the mission requirements and intended performance characteristics, and maintain capacity despite a wide variety of external and internal degradation threats. Operations requirements are intended to keep the airframe within the design mission requirements and loading envelopes. **Damage tolerance is the design capability most closely associated with safety.**

**These key ASIP strategies have been based on the experience that the major aircraft accidents that can be traced to structural causes (16 of 216 major accidents from 1958-1980 or 7 %) have involved the failure of 2 to 3 of these strategies [2.5].** ASIP practices have been evolutionary. They are firmly founded on past errors and experiences so as to minimize repetitions of painful experience.

### **Technical System Tasks**

The technical systems of Type Certification (Design) ASIP can be organized into five inter-related Tasks [2.1, 2.4]:

- Task I - **Design Information**
- Task II - **Design Analyses and Development Tests**
- Task III - **Full-Scale Testing**
- Task IV - **Force Management Data**
- Task V - **Force Management**

The primary components that comprise each of these tasks are summarized in Table 2.6.

### **Design Objectives**

**The primary ASIP design objective is to create an efficient and durable airframe devoid of unanticipated costly maintenance requirements.**

The primary airframe components consist of the wing, fuselage, tail assembly, landing gear, control surfaces, and engine mounts. These components are designed to specific static and dynamic maximum loading and deformation conditions, to meet given deformation and functional criteria, and to be able to meet expected service loading requirements.

The strength design (taxi, take-off, flight, landing) conditions are specified to represent the expected maximum envelope of external and internal loads during the lifetime of the aircraft. These conditions have been

based on extensive instrumentation and flight monitoring programs and data evaluations. As noted earlier, operations requirements are intended to keep the airframe operating within these envelopes. This requires strict and constant attention to operator (pilot) training, testing, and verification.

It is here that military and commercial aircraft have their greatest differences. Military aircraft have a much more demanding and complex set of mission requirements. Tactical, combatant airframes are frequently forced to engage in usage far beyond the design operating envelopes. Much more rapid structural degradation, more maintenance and inspection, and in many cases, major modifications to the airframes are the result of such demands. Commercial transport are designed to a few specific route profiles, weights, mission durations, and a few specific operator training and capability profiles.

For commercial airframes, **the basic structural strength requirement is that the structure must be able to withstand the expected maximum lifetime loading without excessive deformation. In addition, the airframe must be able to withstand 150 percent of these expected maximum loads without failing** [2.1]. This capability is verified by extensive verification of the envelope design loadings (instrumentation, flight tests, and monitoring), and structural analysis supported by testing. Full static loading proof tests of components and entire assemblies (e.g. fuselage) to design and ultimate load levels are intended to provide validation of the analytical models.

For fatigue certification, Federal Air Regulations (FAR) require that critical structural parts be identified and designed to have either **adequate fatigue life** under the anticipated service loads (**safe life approach**) or **adequate fail safety (capability to sustain specified loads after failure of a structural element)**. The safe life approach is based on slow crack growth. The fail safe approach is based on the use of redundant structures and crack arrest structures. A redundant structure is one that given a failure in a primary component, the remaining structure will not fail. A crack arrest structure is one that is designed to stop unstable crack growth in such a way that the remaining structure will not fail.

There are different degrees of inspectability for the fail safe intact and damaged structures [2.9, 2.2]. The intact structure elements for the fail safe design can be classified as either a) non-inspectable, or b) base level inspectable. The undamaged structure elements (for a given damage scenario) can be classified as a) base level inspectable, b) special visual, c) walk-around visual, d) ground evident and e) flight evident.

Damage cannot readily be detected for non-inspectable structure. For base level inspectable structure, damage can be detected using standard NDT techniques (Table 2.7) [2.1, 2.2]. Special visual inspections involve the use of simple visual aids such as optical magnification devices. Walk-around visual inspections are performed by inspection personnel at the

ground level without the use of special inspection aids. Ground evident inspectable structure is structure in which damage will be obvious to ground personnel without specifically inspecting the structure. Flight evident inspectable structure is structure where damage which occurs in flight will have characteristics which are readily ascertainable by the flight crew.

### **Durability and Damage Tolerant Design**

A cornerstone of durability analysis is **fracture mechanics**. Fracture mechanics analysis techniques were developed and employed to provide a means of computing crack growth rates and critical crack sizes for structures with a degree of practicality and reality consistent with that of strength and fatigue calculations. This technology has been pivotal in development of **damage tolerant ASIP** [2.10-2.13].

**Damage tolerant design** involves two primary evaluations:

- a) **Crack growth prediction, and**
- b) **Residual strength prediction.**

Crack growth prediction provides insights to assist in definition of the need to make repairs and the timing of inspections and replacement operations. Residual strength prediction provides information on the load capacity that remains after the structure elements and components have experienced cracking.

These two elements are combined with five major types of nondestructive testing methods (Table 2.7) to determine inspection interval frequencies. The **primary tasks involved in damage tolerance evaluations are summarized in Table 2.8** [2.14].

**Damage tolerance design requirements include the assumption of the existence of initial primary damage in each critical structural element. This primary damage is assumed at the most unfavorable locations and orientations with respect to applied stresses and material properties. The primary damage is assumed to be an initial flaw representative of the original quality of the structure. The original quality is a function of the structure design and quality control-quality assurance procedures that will be used in construction** [2.15].

The size of the assumed initial primary damage is a function of the design concept and degree of inspectability of the structure. The size of initial flaw is based on the size that can be detected with a 90-percent probability and 95-percent confidence.

In addition to the initial primary damage at a given critical location, initial continuing damage of a specified size is assumed to exist at certain adjacent locations. The airframe must be designed to meet certain crack

---

## Marine Structural Integrity Programs

---

growth and residual strength requirements with this initial damage present such that catastrophic failure of the aircraft does not occur within specified time intervals (Table 2.9) [2.15, 2.16].

The crack growth and residual strength (load that must be carried after crack growth damage) requirements for the intact and remaining structure are summarized in Table 2.9 [2.15, 2.16].

The residual strength for the intact structure must be equal to or greater than the design limit load, but need not be greater than 1.2 times the maximum load expected in one lifetime. In addition to the residual strength requirements of the intact structure before load path failure or crack arrest, there is a requirement to sustain a minimum load at the instant of load-path failure or crack arrest. The residual strength at load-path failure must be equal to the design limit load or 1.15 times the residual strength requirement of the intact structure, whichever is greater. The factor 1.15 is a dynamic loading factor. Following load path failure or crack arrest, crack growth and residual strength requirements must also be met for the remaining structure.

**The critical locations for damage tolerance evaluations are those which contribute significantly to carrying flight, ground, and pressurization loads, and whose failure, if undetected, could eventually lead to loss of the aircraft.** The selection of critical locations takes into account [2.16]:

- a) A review of static stress analyses to disclose areas primarily subjected to tension and shear loading and where static margins are a minimum.
- b) Locations of high stress concentrations or where a number of surfaces may intersect each other.
- c) Locations of high stress spectrum severity and where a large number of cycles may occur during each flight.
- d) Locations where stresses would be high in secondary members after primary member failure.
- e) Locations in materials where crack propagation rates are high and fracture toughness values are low.
- f) Locations where maintenance programs have indicated a high likelihood of defects and damage.
- g) Locations of likely fatigue damage and crack propagation paths, particularly where the crack path may be affected by multiple site (multiple elements) damage.



**The number of critical locations to be considered must be consistent with assuring that adequate coverage exists to maintain airframe safety [2.14, 2.15].**

For redundant structures, the initial damage used in the crack growth and residual strength predictions for the remaining structure is the failed load path plus the damage assumed in the adjacent structure.

For independent structure, the damage assumed in the adjacent structure is specified together with the amount of growth that occurs before load-path failure. Independent structure is structure in which it is unlikely that a common source of cracking exists in adjacent load paths at one location because of the nature of the assembly or manufacturing procedures.

For dependent structure, more extensive damage is specified in the adjacent structure. Dependent structure is structure in which a common source of cracking exists in adjacent load paths at one location caused by the nature of the assembly or manufacturing procedures.

For crack arrest structure, the initial damage used in the crack growth and residual strength predictions for the remaining structure is the primary damage following arrest plus the damage assumed in the structure adjacent to the primary damage. For conventional skin-stringer structure, the primary damage following arrest is assumed to be two panels of cracked skin plus the broken central stringer. If tear straps are provided between the stringers, the primary damage is assumed to be the cracked skin between tear straps plus the broken central stringer.

Generally, there has not been a requirement to physically demonstrate the safe life or fail safe characteristics other than by verified analyses [2.14]. Testing is used to verify the analysis methodologies and results. Emphasis is given to the use of fatigue and fracture resistant materials and connections. Design development tests are required to provide an early evaluation of the damage tolerance of the structure as well as the accuracy of the crack growth and residual strength analysis used in design. A wide range of geometric and loading combinations are used in the tests. Temperature and corrosion effects are incorporated in the tests. The types of test specimens can range from simple coupons and elements to complex splices, joints, and wing-fuselage structural sub-assemblies.

Inspections are required during the damage tolerance testing. The type of inspections performed is a function of the inspections proposed for the component and the degree of inspectability. A destructive tear-down inspection is also required after completion of the damage tolerance testing, which includes disassembly and laboratory inspection of the fracture critical areas. Inspection proof tests may be performed on components, assemblies, or complete airframes.

**It is important to note that for present ASIP, fail safe design is used for all airframe components except the landing gear. The landing gear is designed using the safe life approach. Then the landing gear is replaced at one-third of its verified fatigue life. The safe life approach is not accepted for any primary structure [2.14, 2.15].**

Three major lessons developed during the evolution of design for durability. These were that:

- a) Structural safety could not be guaranteed by assuming the design or construction to be free of flaws and defects.**
- b) Emphasis must be placed on specific material production and process controls to ensure uniformity of such vital properties as fracture toughness and connection capacity.**
- c) Development must be focused on improvements in nondestructive inspection (NDI) for production and operations (maintenance).**

**With regard to protecting safety of the airframe, it is assumed that damage, flaws, and defects can exist from the time of manufacture. Experience has shown that ASIP must consider the possibilities of damage in redundant systems, or one can get a false sense of security. One must be able to inspect and verify the integrity of alternative paths if they are to be relied upon.**

**In general, an evaluation of the structure under typical load and environmental conditions, must show that catastrophic failure due to fatigue, corrosion, or accidental damage will be avoided throughout the operational life of the aircraft. This can only be assured with an adequate inspection program. The evaluation must result in inspection and maintenance procedures for each principal structural element whose failure if undetected would lead to catastrophic failure of the airframe.**

**The key to structural safety is required inspections, whether or not the structure is multiple or single load path. The principal objective of damage tolerance evaluations is to provide an inspection program for each principal structural element so that cracking initiated by fatigue, corrosion, or accidents will never propagate to failure prior to detection. An inspection procedure and frequency must be established based on growth from the maximum crack size which can remain undetected after an inspection using the specified inspection methodology. The crack propagation life must be determined for each element under the spectrum of stresses expected in service. Inspection frequencies are based on crack growth life from a detectable length to critical at a prescribed limit load.**

Damage tolerant design features such as slow crack growth and/or fail safe design techniques are incorporated in the structure to protect against the catastrophic effect of undetected or unanticipated flaws. The

damage tolerant, fail safe design philosophy accounts for the possibility of multiple load path redundant structures aging, developing cracks and essentially losing its redundant features. The objective of the operational-inspection-maintenance activities is to detect and arrest the loss of redundancy before there is a significant loss in the capacity and strength of the structure.

The **damage tolerant** ASIP activities can be summarized as follows [2.17]:

- 1) **Design for Damage Tolerance** - including fail safe and slow crack growth concepts, design, analyses and testing.
- 2) **Durability Analysis** - to demonstrate that the design (on element, component, and system bases) is such that the economic life is greater than the design service life, and to determine when the end of economic life is expected to occur.
- 3) **Full Scale Element and Component Tests** - static and cyclic tests to demonstrate for new designs (materials, connections, elements, components) that the design analyses for strength, damage tolerance, and durability have produced realistic results.
- 4) **Force Management** - including loading and environmental conditions (e.g. thermal, corrosion) surveys, tracking programs to ensure anticipated conditions are being experienced, and inspections to disclose defects in the performance characteristics of elements and components.

The **economic life** is characterized in terms of the rapidly increasing rate of cracking in an element or component. Experience has shown that this symptom is directly proportional to a rapid increase in loss of service and repair costs. The general requirement is to **design such that the economic life is of the order of two or more times the design service life.**

A major problem in specifying requirements for durability was the definition and quantification of a level of acceptability and then to be able to demonstrate that the design had met the objectives. Durability limits were defined as the indication of occurrence of widespread cracking in the element or component well in advance of the design life.

It is noteworthy, that **cyclic fatigue tests have been required on each new design of military airframes since the initial introduction of ASIP** [2.2, 2.12]. A major problem has been with the time of delivery of the test results. The solution to this problem has been to program the tests earlier in the development process, requiring demonstration of one design lifetime prior to production go-ahead, and two lifetimes prior to the first production delivery.

---

## **Marine Structural Integrity Programs**

---

Because of the large number of elements and components to be considered in damage tolerance evaluations, a high degree of reliance must be placed on analysis. It is recognized that to test every structural element for damage tolerance characteristics would not be feasible. **Sufficient testing must be performed to assure with a high degree of confidence that the analysis methods are conservative.**

Design for defect tolerance has had its primary effects on the following aspects of airframe structures:

- a) Materials,**
- b) Connections, welding, fastener systems,**
- c) Structural configurations,**
- d) Design stress levels,**
- e) Manufacturing processes and controls,**
- f) Inspection extents and quality, and**
- g) Interdepartmental coordination during design, manufacture, and operation.**

---

## **Continuing Developments**

---

Efforts continue to be exerted to improve the organizational and informational aspects of ASIP. At the present time, these efforts are highlighted by the following activities:

1) **National Aging Aircraft Research Project** - This is an intensive five-year research program that is designed to enhance aircraft safety through better understanding of airframe and power plant structural performance and maintainability, including human factors [2.18]. The program is focusing on causes of in-service structural failures (fatigue, crack growth, debonding, corrosion), failure detection (inspection, monitoring), failure prevention, and remedies (repairs, maintenance) that will better ensure continue airworthiness of the aircraft.

2) **Upgrading Skills of FAA Employees** - this effort is focused on increasing the numbers, capabilities, and experience of the **engineers involved in rule making and design certifications, and inspectors involved in production and maintenance activities and certifications.** This involves upgrading pay scales so that the FAA can attract and retain the high quality personnel that are required for these activities.

3) **Updating the Type and Maintenance Certification Processes** - this effort is aimed at **reducing the regulatory drag** involved in these certification processes (more efficient rule making and inspections), performing **more and better quality type certification reviews** (earlier in the process, more frequently at key milestone developments), performing **more proactive inspections** (lessening reactive after incident activities), **increasing the surveillance and intensity of critical maintenance procedures inspections**, and **updating the licensing processes** associated with ASIP maintenance activities).

4) **Organizing And Conducting Annual Industry Problem Identification Meetings** - this effort is aimed at reinstating annual meetings between key representatives of the FAA, manufacturing, and operating organizations to discuss developing problems and how they might best be resolved, with particular emphasis given to the problems associated with maintenance of airworthiness [2.19].

5) **Improvements in and Continued Development of Industry Information and Communications Systems** - this effort is focused on integrating the existing FAA information system throughout the FAA-manufacturer-operator ASIP framework, to improve the data retrieval and analysis processes incorporated in this system, and improve the data dissemination processes to the various organizations.

These current developments give a clear indication of an industry that recognizes the dangers of organizational and informational complacency. The industry recognizes the needs to continue to improve.

**Experience has indicated that the real test of an ASIP process lies in the quality of its products, not in its organizational elegance.**

---

## References

---

- [2.1] Warren, D. S. (1983). *Design and Inspection Inter-relation for Commercial Jet Transport Structure, Proceedings Int. Symposium The Role of Design, Inspection, and Redundancy in Marine Structural Reliability*, Committee on Marine Structures, Marine Board, National Research Council, National Academy Press, Washington, D. C.
- [2.2] Wood, H. A. (1983). *The USAF Approach to Structural Life Management, Proceedings Int. Symposium The Role of Design, Inspection, and Redundancy in Marine Structural Reliability*, Committee on Marine Structures, Marine Board, National Research Council, National Academy Press, Washington, D. C.
- [2.3] Committee on FAA Airworthiness Certification Procedures (1980). *Improving Aircraft Safety, FAA Certification of Commercial Passenger*

---

## Marine Structural Integrity Programs

---

**Aircraft**, Assembly of Engineering, National Academy of Sciences, Washington, D. C.

[2.4] General Accounting Office (1990). ***How to Improve the Federal Aviation Administration's Ability to Deal with Safety Hazards***, Report by the Comptroller General of the United States, CED 80-66, GAO, Washington, D. C.

[2.4] Sharman, D. (1990). ***FAA Organization***, Federal Aviation Administration, Long Beach, Ca.

[2.5] Harradine, P.J., and Warner, D. W. (1991). ***Assurance of Safety in the Aging Aircraft Fleet***, Boeing Commercial Airplane Group, Seattle, Wa.

[2.6] Rudd, J. L. (1981). ***Air Force Damage Tolerance Design Philosophy, Proceedings Symposium on Damage Tolerance of Metallic Structures: Analysis Methods and Applications***, ASTM Special Technical Publication 842, Philadelphia, Pa.

[2.7] Department of Defense (1982). ***Aircraft Structural Integrity Program, Airplane Requirements***, Military Standard MIL-STD-1530A (11).

[2.8] Department of Defense (1980). ***Aircraft Structural Integrity Master Plan***, AFSC (ASD), DI-S-3570A.

[2.9] Department of Transportation, Federal Aviation Administration (1981). ***Supplemental Structural Inspection Program for Large Transport Category Airplanes, Advisory Circular, AC 91-56***.

[2.10] Swift, T. (1972). ***The Application of Fracture Mechanics to the Design of Damage-Tolerant Stiffened Aircraft Structure, Proceedings American Society for Metals 1972 Westec Conference***, Los Angeles, Ca.

[2.11] Yang, J. N., Hsi, W. H., and Manning, S. D. (1985). ***Stochastic Crack Propagation with Applications to Durability and Damage Tolerance Analysis***, Flight Dynamics Laboratory, Wright-Patterson Air Force Base, AFWAL-TR-85-3062.

[2.12] Manning, S. D., and Yang, J. N. (1987). ***Advanced Durability Analysis***, Flight Dynamics Laboratory, Wright-Patterson Air Force Base, AFWAL-TR-86-3017.

[2.13] Manning, S. D., and Yang, J. N. (1984). ***USAF Durability Design Handbook: Guidelines for the Analysis and Design of Durable Aircraft Structures, Vol. I - VII***, Flight Dynamics Laboratory, Wright-Patterson Air Force Base, AFWAL-TR-86-3017.

- [2.14] Swift, T. (1983). *Verification of Methods for Damage Tolerance Evaluation of Aircraft Structures to FAA Requirements*, 12th Int. Committee on Aeronautical Fatigue, Toulouse, France.
- [2.15] Swift, T. (1987). *Damage Tolerance in Pressurized Fuselages*, Int. Committee on Aeronautical Fatigue, New Materials and Fatigue Resistant Aircraft Design, Ottawa, Canada.
- [2.16] Swift, T. (1978). *Damage Tolerance Analysis of Redundant Structures and Design of Redundant Structures*, Fracture Mechanics Design Methodology AGARD-NATO Lecture Series, Delft, Netherlands; Munich Germany; and Lisbon, Portugal.
- [2.17] Swift, T. (1990). *Damage Tolerance Technology, A Course in Stress Analysis Oriented Fracture Mechanics: Fundamentals, Residual Strength, and Crack Propagation*, Federal Aviation Administration.
- [2.18] U. S. Dept. of Transportation, Federal Aviation Administration (1989). *Program Plan, National Aging Aircraft Research Program*, Technical Center, Atlantic City Int. Airport, New Jersey, DOT/FAA/CT-88/32.
- [2.19] Cooper, T. D., and Lincoln, J. W. (1989). *Proceedings of the 1989 Structural Integrity Program Conference*, Materials Laboratory, Wright-Patterson AFB, WRDC-TR-90-4-51.

**Table 2.1 - ASIP Responsibilities**

<b>SEGMENT</b>	<b>RESPONSIBILITIES</b>
<b>FAA</b>	<ol style="list-style-type: none"> <li>1) Develop and issue technical standards and regulations.</li> <li>2) Perform, evaluate, and report results of design and manufacturing reviews and inspections.</li> <li>3) Perform, evaluate, and report results of operations and maintenance inspections.</li> </ol>
<b>Production</b>	<ol style="list-style-type: none"> <li>1) Develop and design the aircraft and ASIP to meet or exceed industry and FAA standards and requirements.</li> <li>2) Manufacture the aircraft to meet or exceed industry and FAA standards and requirements.</li> <li>3) Develop preventative maintenance and modification programs.</li> <li>4) Recommend minimum standard inspections.</li> <li>5) Recommend fleet campaigns, special inspections, and modifications.</li> <li>6) Supply spares and information.</li> <li>7) Review and analyze data from inspections, sales of spares, information requests, and field service reports.</li> <li>8) Develop product improvements.</li> <li>9) Perform continuing liaison with regulatory and owner/operator organizations.</li> <li>10) Conduct regular operator education programs.</li> </ol>
<b>Owner - Operator</b>	<ol style="list-style-type: none"> <li>1) Operate and maintain the aircraft within its intended operating envelopes.</li> <li>2) Develop approved standard inspection and maintenance programs.</li> <li>3) Perform continuing inspection and maintenance.</li> <li>4) Conduct fleet campaigns, special inspections, and modifications.</li> <li>5) Provide information feedback to the responsible regulatory and production-maintenance organizations, and other operators.</li> <li>6) Develop and recommend product improvements.</li> <li>7) Perform continuing liaison with regulatory and production maintenance organizations.</li> </ol>



**Table 2.2 - FAA Employees Types, Qualifications, Responsibilities**

<b>Type</b>	<b>Qualifications</b>	<b>Responsibilities</b>
<b>Engineer</b>	Appropriate degrees and experience in industry engineering organizations.	<ol style="list-style-type: none"> <li>1. Review design data submitted by applicant and approve if found in compliance with the Federal Air Regulations (FAR).</li> <li>2. Conduct FAR compliance inspections and witness tests.</li> <li>3. Conduct flight tests to verify applicant's showing of compliance.</li> <li>4. Issue Type Certificates and Supplemental Type Certificates.</li> </ol>
<b>Manufacturing Inspector</b>	Experience in industry quality assurance organizations in inspection and inspection supervision.	<ol style="list-style-type: none"> <li>1. Conduct conformity inspections of prototype or test articles in support of FAA engineering in design approval projects.</li> <li>2. Evaluate production facilities and quality assurance systems of applicants for production approvals.</li> <li>3. Recommend issuance of production approvals when an applicant's facility and QA system are found in compliance with the FAR.</li> <li>4. Conduct surveillance of approved production facilities.</li> <li>5. Issue airworthiness certificates or export approvals for products found in conformity to the FAA approved design data.</li> </ol>

**Table 2.2 - FAA Employees Types, Qualifications, Responsibilities**

<b>Type</b>	<b>Qualifications</b>	<b>Responsibilities</b>
<b>Test Pilots</b>	Ratings and experience appropriate to the categories of aircraft to be flown.	<ol style="list-style-type: none"> <li>1. Approve flight test programs and conduct flight tests and other evaluations as necessary to find compliance with the applicable FARs.</li> <li>2. Conduct flight tests as required by the Type Inspection Authorization to evaluate operational characteristics of new or amended type designs submitted to the FAA for approval</li> </ol>
<b>Aircraft Evaluation Group</b>	Applicable type ratings and experience in transport category aircraft operations.	<ol style="list-style-type: none"> <li>1. Determine the pilot type rating and training requirements for transport category aircraft.</li> <li>2. Evaluate transport category aircraft designs to determine compliance with the operational and equipment requirements of the FAR applicable to Air Carriers and commercial operators.</li> <li>3. Make recommendations for changes to type designs that may be required to meet the operations requirements.</li> <li>4. Determine the items of equipment that may be inoperative for dispatch in accordance with a Master Minimum Equipment List.</li> </ol>

**Table 2.2 - FAA Employees Types, Qualifications, Responsibilities**

Type	Qualifications	Responsibilities
<b>Airworthiness Inspectors</b>	Applicable aircraft / power plant / radio ratings and experience in transport category aircraft maintenance programs.	<ol style="list-style-type: none"><li data-bbox="834 442 1392 689">1. Evaluate transport category aircraft designs to determine compliance with the operational and equipment requirements of the FARs applicable to air carriers and commercial and other operators of transport category aircraft.</li><li data-bbox="834 725 1392 832">2. Determine the acceptability of the manufacturers recommended maintenance program.</li></ol>

**Table 2.3 - Designated Engineering Representatives**

<b>Types</b>	<b>Qualifications</b>	<b>Responsibilities</b>
<p><b>Designated Engineer Representatives (DER)</b></p>	<ol style="list-style-type: none"> <li>1. Appropriate degrees and experience.</li> <li>2. Familiarity of FAA certification programs.</li> <li>3. Knowledge of FAA regulations and procedures.</li> </ol>	<p><b>Employees of the Manufacturer</b></p> <ol style="list-style-type: none"> <li>1. Approve or recommend approval of design data forming the basis for issuance of Type Certificates or amendments to Type Certificates as authorized by the FAA appointing office.</li> <li>2. Conduct compliance inspections and witness tests as authorized by the FAA appointing office.</li> <li>3. Recommend approval of flight test programs and conduct flight tests and other evaluations as authorized by the FAA appointing office.</li> <li>4. Perform other functions as authorized by the FAA appointing office.</li> </ol> <p><b>Consultant DER</b></p> <p>An independent DER who charges a fee for his DER services. Consultant DERs are usually involved in modification projects, ultimately approved through issuance by the FAA of Supplemental Type Certificates. Functions are generally the same as those for a manufacturers employee DER.</p>

**Table 2.4 - Designated Manufacturing Inspection Representative**

Type	Qualifications	Responsibilities
<b>Designated Manufacturing Inspection Representative (DMIR)</b>	<p>Experience in industry quality assurance organizations in inspection and inspection supervision.</p> <p>All DMIRs are employees of the holder of an FAA production approval.</p>	<ol style="list-style-type: none"> <li>1. Conduct conformity inspections of prototype or test articles in support of FAA engineering in design approval projects, as authorized by, and under the direct supervision of FAA Manufacturing Inspectors.</li> <li>2. Issue airworthiness certificates or export approvals for products product by the DMIRs employer.</li> <li>3. Perform authorized functions at any location authorized by the DMIRs appointing office.</li> </ol> <p><b>DMIRs are not authorized to perform any functions related to his employer's production approval, such as quality assurance audits or surveillance, because of conflict of interest ramifications of such actions. The functions involved with initial approval and subsequent surveillance of production facilities are reserved for FAA Manufacturing Inspectors.</b></p>

**Table 2.5 - Designated Airworthiness Representative**

Type	Qualifications	Responsibilities
<p><b>Designated Airworthiness Representative (DAR)</b></p>	<p>Experience in airworthiness certification functions that can only be gained through previous employment as an FAA inspector or as a DMIR.</p> <p>Most DARs are private individuals working on a consultant basis charging a fee for their services.</p> <p>Organizations such as manufacturers or repair stations may also be appointed as DARs</p>	<ol style="list-style-type: none"> <li>1. Issue airworthiness certificates or export approvals as authorized by the FAA appointing office for products found to conform to the FAA approved design data.</li> <li>2. Conduct conformity inspections of prototype or test articles to be used in type certification or supplemental type certification programs.</li> <li>3. Issue conformity certifications for components manufactured by U.S. suppliers for foreign product manufacturers, when requested by the civil air authority of the country in which the manufacturer is located.</li> </ol> <p><b>DARs appointment is valid for any make of product for which he is found qualified, either new or used, and located either in the U.S. or abroad. DARs employer may be anyone, such as a domestic or foreign air carrier, an exporting company or individual, or a repair station.</b></p>

Table 2.6 - ASIP Tasks and Components

Task I	Task II	Task III	Task IV	Task V
<b>Design Information</b>	<b>Design Analyses and Development Tests</b>	<b>Full-Scale Testing</b>	<b>Force Management Data Package</b>	<b>Force Management</b>
ASIP Master Plan	Materials and Joints Allowable	Static Tests	Final Analyses	Loads Environment Spectra Survey
Structural Design Criteria	Load Analyses	Durability Tests	Strength Summaries	Individual Airplane Tracking Data
Damage Tolerance Plan	Design Service Loads Spectra	Damage Tolerance Tests	Force Structural Maintenance Plan	Individual Airplane Maintenance Programming
Durability Control Plan	Design Chemical and Thermal Environment Spectra	Flight & Ground Operations Tests	Loads Environment Spectra Survey	Structural Maintenance Recording and Evaluation
Selection of Materials, Processes, and Joining Methods	Stress Analyses	Sonic Tests Flight Vibration Tests	Individual Airplane Tracking program	
Definition of Design Service Life and Design Usage	Damage Tolerance Analyses	Flutter Tests		
	Durability Analyses	Interpretation & Evaluation of Test Results		
	Sonic, Vibration, and Flutter Analyses			
	Weapons effects analyses (military)			
	Design development testing program			

**Table 2.7- Nondestructive Testing Methods**

<b>Method</b>	<b>Application</b>	<b>Advantages</b>	<b>Disadvantages</b>
<b>Visual Optical</b>	Detection of surface defects of structural damage	Simple to use in areas where other methods are impractical. Optical aids used to enhance detection.	Reliability depends upon the ability and experience of the user. Accessibility required for direct visibility or borescope.
<b>Dye Penetrant</b>	Detection of surface cracks in all metals, castings, forgings, machine parts, weldments.	Simple to use, accurate, fast, easy to interpret.	Defect must be open to surface and accessible to operator. Defect may be covered by smeared metal. Part must be cleaned before and after check.
<b>Ultrasonic</b>	Detection of surface and subsurface defects, cracks, debonds, laminar flaws, and thickness gaging in most metals by pulse-echo techniques	Fast, dependable, is easy to operate. Results are immediately known. Highly accurate, highly sensitive and portable.	Trained operator required. Electrical source required. Crack plane orientation must be known to select wave mode to be used. Test standards required to establish instrument sensitivity



**Table 2.7- Nondestructive Testing Methods**

<b>Method</b>	<b>Application</b>	<b>Advantages</b>	<b>Disadvantages</b>
<b>X-Ray</b>	Detection of internal flaws and defects such as cracks, corrosion, inclusions, and thickness variations.	Eliminates many disassembly requirements. Has high sensitivity and provides a permanent record on film.	Radiation hazard. Trained operators and film processing equipment required. Crack plane must be nearly parallel to X-Ray beam to be detected. Electrical source required. Special equipment required to position X-Ray tube and film.
<b>Sonic</b>	Detection of delaminations, debonds, voids, and crushed core in composite and honeycomb materials.	Can be accomplished from one surface. Direct reading. Does not require paint removal or special surface preparation	Loses sensitivity with increasing material thickness. Electrical source required.

**Table 2.8- Damage Tolerance Evaluation Tasks**

---

<b>Task No.</b>	<b>Description</b>
1.	Define the intended uses of the aircraft (utilization specification)
2.	Develop the design loadings spectra and conditions
3.	Select the critical locations for the damage tolerance evaluations
4.	Develop the stress (strain) spectra for each critical location
5.	Establish the operational and maintenance environment for each critical location
6.	Develop crack growth rate data for each critical location
7.	Validate the basic crack growth analysis methods
8.	Obtain fracture toughness data for each material and geometry
9.	Determine maximum extent of damage for each location under the design limit load conditions
10.	Validate the residual strength analysis methods
11.	Determine the structural category for each critical location
12.	Produce a crack growth curve for each critical location
13.	Quality assure the analyses and evaluations
14.	Define inspection methods and frequencies consistent with operational economics

**Table 2.9- Fail Safe Design Crack Growth and Residual Strength Requirements**

<b>Inspectability</b>	<b>Safe Crack Growth Interval</b>	<b>Residual Strength, Maximum Load in</b>
<b>Intact Structure</b>		
Base Level	1/4 lifetime	5 lifetimes
Non-inspectable	1	20 lifetimes
<b>Remaining Structure</b>		
Base Level	1/2 lifetime	5 lifetimes
Special Visual	2 years	50 years
Walk-Around Visual	50 flights	1000 flights
Ground Evident	one flight	100 flights
Flight Evident	return to base	100 flights

*This Page Intentionally Left Blank*

# Chapter 3

## MARINE STRUCTURAL INTEGRITY PROGRAMS

### Background

---

**The objective of this chapter is to develop a general definition of the elements of the life cycle of crude carrier (tanker) structural systems that should be considered in development of an advanced MSIP.**

At the present time, a wide variety of MSIP are being used for commercial ships. These range from highly advanced and structured life-cycle, full-scope MSIP to minimum MSIP as required by classification societies. There is a wide range of requirements and practice regarding minimum MSIP among the classification societies.

Given the current rash of troubles with tanker structures and tanker operations, there are extreme political and public pressures being brought upon regulators, owners and operators, and classification societies to see that these troubles are brought under control. Improved MSIP is a high priority concern and objective.

Even though the majority of the current accidents are fundamentally unrelated to the ship structures (most accidents are related to human and organization errors), there have been unsettling experiences with tanker structures prematurely developing cracks in critical structural elements. Significant pollution events have developed from several of these experiences.

Unanticipated durability problems and unscheduled repair operations have been the primary result of ship structure problems. These recent symptoms provide insights into needed improvements in present MSIP.

There is a wide variety of commercial ships including general cargo, oil tankers, bulk carriers, general cargo, lumber carriers, chemical tankers, ore carriers, L.P.G. tankers, container carriers, car carriers and passenger carriers. Each of these types of ships poses a different set of structural integrity problems and potential hazards and consequences. **The degree of development and sophistication of advanced MSIP should be**

**in balance with the potential hazards and consequences posed by operations of a particular type of ship.**

In the following MSIP developments, attention will be focused on moderate to high consequence ships such as oil, chemical, and L.P.G. tankers, **with specific focus on oil tankers and crude carriers.**

This is a particularly critical focus because of current public attention on the safety of crude carriers. This focus is also important because of the extreme cost cutting and manpower reduction pressures that have confronted this entire industry during the last ten years. Organizational and manpower redundancy and robustness have been reduced to critically low levels. These factors have had dramatic influences on MSIP.

This section will address the recent developments, ASIP applications to MSIP, advanced MSIP philosophy, and key organizational and technical developments required for advanced MSIP. Subsequent sections of this report will develop details associated with the key technical developments.

---

### **Recent Developments**

---

Recent developments concerning damages to major structural hull members and maintenance programs implemented to address these damages provide important insights into where and how advanced MSIP developments are needed.

### **NKK Survey Results**

Nippon Kaiji Kyokai (NKK), the Japanese classification society, recently has published survey results from the fleet of commercial ships classified by NKK [3.1]. This fleet includes general cargo ships, oil tankers, bulk carriers, general cargo and lumber carriers, ore carriers, L.P.G. tankers, container carriers, car carriers, and other ships with ages from 1 to 25 years. There are 519 ships in this fleet.

Figure 3.1 summarizes the types of damage to critical hull members for all of the types of ships [3.1]. The damage includes corrosion, structure (cracking), vibration (cracking), and others (e.g. collision caused buckling). Damage was defined as defects or deterioration requiring repairs.

Damage due to corrosion accounts for more than half the total damage. Damage due to corrosion starts to take place at about 4 years, the frequency increases steadily to about 15 years, and then levels off until 25 years.

Figure 3.2 summarizes the number of corrosion related damages to cargo, ballast, and other spaces in the ships for all structural members as a function of ship age [3.1]. Figure 3.3 summarizes corrosion damage to side shell elements (excluding all other internal components) [3.1].

Figure 3.4 summarizes damages to critical frame members in the side shell [3.1]. Side shell plate damages are relatively few compared with the critical frame members. Corrosion related damages account for the majority of damage starting at about the 7th year. Structure cracking can start at the first year, and apparently accounts for little damage after about the 20th year.

**It is interesting to note that when both corrosion and cracking damages are present in the members, the damage is most frequently attributed to corrosion, and the cracking is not reported.**

Table 3.1 summarizes the relative frequency (percentage) of damages according to major structural hull members and type of ship **for all classes of ships** [3.1]. The uppermost numerals for each structural member indicate the ratio (percentage) of damages in a particular kind of ship in a particular type of structural member due to all causes to the total damages for all ships. The sum of the uppermost numerals is 100 percent.

The lowermost numerals in Table 3.1 indicate the ratio (percentage) of corrosion damages to the total damages for all ships. The difference between the uppermost and lowermost numerals indicates the percentage of damages due to cracking and buckling as a proportion of the total damages to all ships.

The greatest proportion of damages to the upper deck structures occur in general cargo and lumber carriers. The greatest frequency of damages to bottom shell structures occur in oil tankers and other ships (e.g. chemical carriers). The majority of these damages are due to causes other than corrosion (fatigue cracks, grounding damages). Container carriers and L.P.G. tankers account for the lowest proportion of damages to the various classes of ships.

Table 3.2 summarizes the relative frequency (percentage) of damages according to major structural hull members **as a proportion of the total damage in each ship type** [3.1]. The uppermost numerals indicate the ratio of the number of damages to the structural members due to all causes to the total damage in each ship type. The lowermost numerals indicate the ratio of corrosion related damages to the structural members to the total damage in each ship type.

In oil tankers, 53 percent of damages occur to bulkhead members, and 57 percent of these damages are due to corrosion. Sixteen percent of the damages occur in side shell elements and 38 percent of these damages are due to corrosion (62 percent due to cracking). Ten percent of the damage

occurs to upper deck members and 90 percent of these damages are due to corrosion (10 percent due to cracking).

These figures provide valuable insights into when, where, and how structural damages are occurring in a wide variety of ships, operated in a wide variety of services. The results are consistent with those from other similar surveys (Figs. 3.5, 3.6) [3.2]. **The results indicate corrosion is the most common form of defect requiring repairs. Corrosion is often a contributing factor to cracking. The extent of corrosion is primarily dependent upon protection initially provided and its maintenance.**

**The results also indicate that cracking is generally associated with welds and stress concentrations and is the second most common source of damage (Figs. 3.7, 3.8) [3.3, 3.4]. Detailed analysis of the results indicates that the use of high strength steels with correspondingly higher general stress levels again makes fatigue cracking more likely (the fatigue strength does not increase in proportion to the yield or ultimate tensile strength) [3.4].**

### **MHI VLCC Recall**

In August 1990, Mitsubishi Heavy Industries (MHI) recalled six of its second generation very large crude carriers (240,000 to 260,000 dwt) after major cracks were found in the cargo tanks of one delivered less than five years ago [3.5]. The cracks were discovered when oil was detected in the ballast tanks. Several of these vessels had recently undergone inspections (these inspections failed to disclose the cracking that was subsequently discovered).

The cracks occurred in the side shell longitudinals, close to the point where they meet the transverse bulkheads and frames, about two-thirds up the side. The side shell and longitudinals were made from high tensile steel. An illustration of the cracking is shown in Figures 3.9 through 3.14 [3.6]. Face plates and / or the web plates of the side longitudinals were cracked at the intersection with the transverse bulkheads.

As a result of this experience, detailed inspections were conducted on about 30 second generation VLCCs. Fatigue cracking found in these vessels could be categorized into two types:

- Cracks initiating in the weld heat affected zone of the face plates to the collar plates, and
- Cracks starting from the heat affected zone of the welds of the side longitudinals to the web stiffeners.



Both types of cracks propagate into side shell longitudinal web plates after breaking through or penetrating the face plate, possibly resulting in side shell cracking.

No significant corrosion was associated with the initiation or propagation of the cracking.

In the first generation VLCCs built of mild steel by MHI, most cracking initiated in the welds of the side longitudinals and web stiffeners along the face plate of side longitudinals. This is in contrast with the second generation VLCCs where cracking started approximately vertical to the face plate at the position of the toes and/or heels of tripping brackets or web stiffeners.

Figure 3.15 shows the repairs to the second generation VLCCs [3.6]. Side longitudinals were reinforced at the intersections with the transverse bulkheads by soft toe brackets. As indicated in Figure 3.16, reinforcement was placed on all longitudinals within the middle one-third of the side shell

**From damage analyses of the failed details, MHI has concluded that the problem is founded in basically insufficient fatigue strength [3.5, 3.6]. The primary remedy being used is to lower the level of working stresses of the side longitudinals to that comparable with those of the first generation VLCCs built mainly of mild steel.**

Detailed finite element analyses of the failed details indicate that excessive stresses are caused by discontinuities at the connection of the face plate of side longitudinals and web stiffeners or tripping brackets, and the asymmetrical section of the side longitudinals. High torsional stresses are induced in such details; the more asymmetrical the section, the bigger the peak value of stress. Symmetrical T-sections have peak stresses that could be as much as 60-percent lower than the asymmetrical sections.

It is interesting to note that the asymmetrical sections of the side longitudinals were introduced to facilitate tank cleaning and to minimize the quantity of sludge residues inside cargo oil tanks. In addition, these sections also save construction costs.

An intensive research program has been initiated that is addressing fatigue strength of the materials (parent and welded), dynamic wave loads at the side shell, and hull structure analyses. The research includes measurement of hull stresses and responses during voyages and calibration of loading and structural analytical models.

### SSC Study of Ship Structure Failures

In a recent Ship Structure Committee (SSC) sponsored project [3.7], a three-year investigation was conducted to review ship structure failure case

---

## **Marine Structural Integrity Programs**

---

studies and inspect new ship failures in an effort to determine the modes of serious damages in ship structures. The study represented a cross section of ship types and operational areas. Principal findings of this study include:

- Fatigue cracking was observed or reported in 11 of the 16 cases examined. Fatigue cracking preceded brittle fracture in 9 cases examined. Brittle fracture was observed in 11 of the 16 cases examined. Ductile fracture was located at the point of fracture arrest in two cases examined.
- All of the fractures investigated originated at a design or fabrication detail. The majority of brittle fractures examined originated in steel Grades A and B. Brittle fracture arrest was attributed to riveted construction in 3 cases, and structural redundancy in 1 case. Riveted seams and joints and various forms of structural redundancy appear to be the most effective means of arresting running fractures in ship structures.
- Ship fracture control is the responsibility of those who design, classify, build, operate, inspect and repair ship structures. Selection of proper materials, eliminating design details which cause stress concentrations, ensuring adequate fabrication and welding procedures, and operating the vessel in a prudent manner are key aspects of such an approach.

### **USCG Tanker Study Group Report**

Needed developments in MSIP were indicated from results of a U.S. Coast Guard (USCG) study group concerned with the structural integrity and safety of commercial tankers. **This group defined critical factors influencing structural safety for this class of commercial vessel [3.8]:**

- Structural condition is influenced by age, length, country of registration, class society, quality of surveys and periodic inspections, operating routes, owner maintenance policies, and economic pressures. Tight scheduling with resultant excess speeds contribute to the structural problems. Improved guidance for use of higher strength steels, reduced scantlings, and coating - cathodic protection systems are needed for new ships.
- The USCG computer based Marine Safety Information System (MSIS) potentially is a very valuable source of data and information to help develop better maintenance decisions. However, the data supplied to the system is often incomplete, and excessive data entry times are required. The system duplicates a continuing manual system of data recording. There is inefficient operating feedback to the field, and frequently, critical information is not available to those that must make maintenance decisions.

- Important structural failures have been reported at all times of the year. Trade routes that experience more frequent severe sea states have a higher incidence of structural failures. Failures are most frequently detected at sea by the crew (oil in ballast, oil behind ship). Failures occasionally result in significant loss of cargo and often occur in the mid-ship half length. Many failures are due to improper design, bad workmanship (poor edge preparation, poor welding, poor fit up), and are generally discovered 10 to 15 months after commissioning or the last dry dock inspections.

- Inspections are an almost impossible task on modern tankers due to their size and the number of critical structural details. Quality assurance and control during construction is not good (ships frequently are commissioned with significant structural defects). Structural fatigue can not be detected by normal inspection methods. Visual methods range widely in quality depending on surface preparation and means of conducting the surveys (well lighted staged inspection to rafting the tanks in the dark while underway). **There are too few and not enough well qualified inspectors.**

- Classification societies do a reasonable job, but to rely solely upon them without independent third party oversight is not a good situation. Some vessels have been kept in class with recognized problems. The surveyor is frequently placed in a conflict of objectives and interests between the owner-operator incentives and the classification and regulatory requirements. The surveyor frequently is not given the tools and experience needed to do the required job. There is a wide range in capabilities and results between different surveyors and different ports with inconsistent results. Frequently, there is a confusion of responsibilities. There are too few well trained and motivated inspectors.

- Owners and operators are under very severe economic pressures and operate on very tight profit margins. Tremendous pressures are exerted to get the vessels in and out of port; scheduling is everything. There is a wide range of vessel operators that range from tried and true ship owners to professional investors - managers with secondary interests in the structural integrity of the ship. The perception is that the schedule must be adhered to above all else; **masters drive ships hard in order to meet schedules believing that it is cheaper to repair cracks later than to miss the schedule for loading or discharge.** The present adage is to do more with less. Land-based inspection and maintenance crews performing operations while the ship is underway frequently are not able to perform their intended functions.

- Coast Guard personnel are not well enough trained and technically qualified. There are not enough well trained personnel; inspection and maintenance assignments are frequently perceived to be second class billets (dead end, good way to get passed over, dirty and tiring job, little recognition). There are insufficient personnel to react to changing patterns in

---

## **Marine Structural Integrity Programs**

---

workloads or technical requirements: "to put it bluntly, the job being done is barely adequate, and not anywhere near as good as it should be."

**Decreased budgets, manpower cuts, larger ships, more sophisticated shipboard systems, quicker turn around times, and the shifting emphasis of Coast Guard duties from safety to law enforcement has had far reaching negative effects on MSIP.**

### **USCG TAPS Tanker Structural Failure Study**

In another study of the trans-Alaska Pipeline Service (TAPS) Tanker structural failures [3.9], the Coast Guard identified a number of critical MSIP issues:

- A complete data base on TAPS ships structural failures does not exist; in some cases, structural integrity data has been purposely withheld by the owners and operators.
- Inconsistent, and frequently, ineffective structural repair and maintenance procedures have been used by owners and operators.
- Cargo blocks made of combinations of mild and higher tensile steels (HTS) or solely of HTS are experiencing a higher number of failures than comparable blocks made solely with mild steels.
- Full scantling ships, regardless of steel type, suffer the same proportion of failures as vessels built to reduced scantlings.
- Four yards built 58 percent of the vessels and accounted for 87 percent of the structural failures; these failures were due to poor surface preparation, poor welding, poor detailing, and poor fit up.
- Many critical structural failures are due to poor detail design; detail designs need to be developed that will develop better load paths and lower stress concentrations.
- Coatings can provide good protection to ballast tanks; the key to durability is proper surface preparation, proper application of high quality coatings of sufficient thickness and flexibility, curing, and repairs.
- Single hull tankers comprise 62 percent of the TAPS ships and account for 80 percent of the significant structural failure events.
- Excessive flexure of structural elements and corrosion can combine to cause unanticipated and premature fatigue cracking (e.g. cargo tank bulkheads).

**This study suggested the formation of joint working groups (vessel operators, class societies, new-build and repair yards, U.S. Coast Guard) to address:**

- Critical areas inspection plans and performance requirements.
- Vessel repair information sharing programs.
- Ongoing structural concerns of vessel operators.
- Safe procedures for entry of tanks when internal surveys are conducted.
- Maintenance of corrosion control systems.
- Enhancement of classification society rules and policies pertaining to vessel structure analysis, design and construction, including alternatives to increase the margins of safety to allow for system uncertainties in construction, operation, and maintenance.
- New policy and inspection guidance that addresses the issues of structural design, fabrication/repair procedures, workmanship, and quality control requirements.
- Specific guidance on construction procedures, repair procedures, and design of structural details.

### **Sea Grant Symposium**

As an indication of the trends regarding development of advanced MSIP, at the Sea Grant Symposium on **Preservation of Ageing Marine Structures** [3.10], John Gosling, General Manager of Engineering, Matson Shipping Company remarked:

**"There is no secret of how to make a ship last. The secret is doing it!"**

**"There are four key things required to realize the long life of a ship:**

- **Start with a policy of long life (design and construct for durability),**
- **Keep control of the ship (don't trust others to see that maintenance is done),**
- **Don't change the policy of high quality maintenance (even in tough economic times), and**

- **Obtain and have the resources to conduct that policy (this takes management commitment to long-term successful ship operations)."**

At the same symposium [3.11], Bob Ternus, vice-president and general manager of Chevron Shipping Company, summarized four key elements of a good structural maintenance program for oil tankers:

- "1. Design for proper maintenance,**
- 2. Design for proper inspection,**
- 3. Develop data handling and evaluation systems, and**
- 4. Develop repair strategies and procedures."**

Additional points developed by Ternus concerning these key elements include the following:

- **Design for maintainability** includes advanced analyses and detailing of both mild and high strength steel elements, more stringent production controls, and advanced durability coating systems.
- **Design for proper inspection** includes design of the hull structure to promote inspections and repairs, improved definition and evaluation guidelines for wastage limits, training and partnering with third-party inspection firms, and organization and scheduling of inspections to promote high quality repairs.
- **Data handling and evaluations** are critical to long-term maintenance. Computer aided systems (e.g. CATSIR, Computer Aided Tanker Structure Inspection and Repair) are being developed to automate the data handling and evaluation processes. This system includes a CAD (Computer Aided Design) graphics package and a tabular data base to aid in the archiving of defects and damage (corrosion, cracking, buckling) and to assist in the repair alternatives evaluation processes.
- A critical element in development of **repair strategies and procedures** is ship yard partnering. Ship operators pre-qualify yards around the world to do their repair work and negotiate the repairs on a unit price basis a year in advance. The owners - operators tell the yards one year in advance to expect the ship and give an estimate of the scope of the work. The yards have CATSIR. In addition, the repair yards are also equipped with a program (SPECGEN) to assist in the archiving of information and evaluation of non-structural (mechanical equipment, piping, electrical systems) work to be done.

---

## ASIP Applications to MSIP

---

The review of ASIP developments summarized in Chapter 2 identified several key potential organizational and technical developments that could be introduced into an advanced MSIP:

- **Centralized archiving, evaluation, and dissemination of potentially important information relating to MSIP.**
- **Training, testing, and verifying the capabilities and performance of design, manufacturing, operations, and maintenance personnel.**
- **Development of cooperative, supportive, and intensely communicative associations among the major sectors including regulatory, classification, owner - operator, and production and maintenance sectors, with a focus on safety and durability issues, avoiding "hidden agendas" and legal impediments to communications.**
- **Development and application of advanced technologies with heavy emphasis on testing and monitoring founded on sophisticated and realistic analyses.**
- **Development and application of a comprehensive approach to engineering for and maintenance of structural reliability.**
- **Design of ship structures that not only address functional and strength requirements, but as well, design for damage and defect tolerance, design for constructability, inspection, and maintainability, with heavy emphasis given to damage tolerant design and durability design to minimize the risks of high consequence accidents and unanticipated maintenance.**

Recent developments regarding ship structures and MSIP summarized in the earlier parts of this chapter in one way or another have touched on each of these categories of ASIP to advanced MSIP developments. **As a whole, the industry recognizes what it can and should do to improve the integrity and durability of ship hull structures. The major challenge is:**

- **Defining how far the developments should be taken to improve integrity and durability,**
- **Defining the details of the MSIP developments,**
- **Obtaining the resources to implement the developments, and**
- **Implementing the developments in practice.**

### **Advanced MSIP**

---

This section will summarize the key elements involved in development, implementation, and continued evolution of an advanced MSIP.

#### **Full Scope**

MSIP should be one component of **full-scope ship integrity programs**. Full-scope ship integrity programs address:

- a) **Structural systems** (integrity, capacity, and durability)
- b) **Equipment systems** (navigation, propulsion, steering, piping, electrical), and
- c) **Operations systems** (vessel traffic control, training, licensing, re-certification).

#### **Life-Cycle**

MSIP should be **life-cycle focused**. Life-cycle ship structural integrity programs must be initiated at the earliest stages of the design phase, and extend throughout the:

- a) **Design phase** (concept, feasibility, configuration, detailing, construction and operations specifications, verification, certification, construction contracts),
- b) **Construction phase** (material acquisition, fabrication, commissioning, inspections, sea trials, classification), and
- c) **Operations phase** (loading-unloading, voyage, inspections, maintenance, repairs, re-classification, scrapping).

#### **Safety and Economy**

MSIP should have two fundamental objectives:

- a) **Develop a desirable level of structural reliability (integrity, durability) for a newly constructed ship structure, and**
- b) **Maintain an acceptable level of structural reliability throughout the ship's life.**



Structural integrity and durability are achieved at a cost (Fig. 3.17) [3.11-3.14]. It is desirable to define MSIP that can minimize total (initial and future) costs for given types of ship structural systems, and yet meet minimum safety requirements.

Present experience with MSIP indicates that the principal problem is not the basic capacity of the ship structure; catastrophic compromise of the ship structure is a rare occurrence generally associated with improper operations (e.g. loading - unloading, grounding, collisions).

**Experience indicates that a principal MSIP problem is associated with unanticipated, and in some cases ignored, maintenance of the ship structure.** Not only are costs associated with the repairs, but as well substantial costs are associated with down-time and unavailability of the ship for its intended purposes. In some cases, inadequate maintenance has led to significant internal and external cargo leaks. External cargo losses carry with them a heavy financial and political burden of pollution and clean-up. These are costs and burdens to be minimized; in practical terms, they can not be eliminated.

A second requirement is to define what constitutes a desirable level of reliability for new systems, and what constitutes an acceptable level of reliability for old systems (Fig. 3.18) [3.12]. These reliability levels become the measures of intended MSIP performance for design and construction of new ship structures, and operations and maintenance of existing ship structures. These levels constitute one important expression of MSIP goals. Generally, this requirement or designation of the MSIP goals is the responsibility of the regulatory segment of the industry.

---

## **Technical Developments**

---

**MSIP should address the technical developments that can enable ship owners and operators, builders, and regulators to realize the safety and economic benefits of more durable and reliable ship structures.** MSIP technical developments should include:

- a) Structural design plans** (addressing the life-cycle phases, design criteria, damage tolerance, durability, materials, and operations);
- b) Structural analysis guidelines** (addressing loadings, strength design, design for durability and damage tolerance (including inspectability, constructability and maintenance);
- c) Requirements for testing of critical components** to demonstrate capacity, durability, and damage tolerance, and in-service monitoring to provide additional information on structure loadings and performance; and

**d) Development of an industry-wide computer data base system** for archiving design and construction information, operations structural tracking and maintenance tracking (including results of monitoring, inspections, maintenance programs, records, repairs, modifications, replacements, and assessments of performance).

The fundamental objective of MSIP is to **help minimize the risks of low probability - high consequence structural failures while maximizing the serviceability and durability of the ship.**

This objective is focused in three key technical strategies:

1) **High Quality Design**- design of a ship structure that is forgiving in its ability to be tolerant of defects, flaws, and damage and is able to maintain the critical aspects of capacity and durability.

2) **High Quality Production** - design and manufacturing processes and procedures, and inspection methods that will assure a high quality ship structure.

3) **High Quality Maintenance** - painstaking attention to inspection, maintenance, and repair/replacement of critical structure details throughout life to maintain the important aspects of capacity and redundancy.

MSIP safety requires that strength (capacity) be achieved and maintained through:

- **High quality production** intended to achieve strength and durability objectives,
- **Maintenance** intended to validate the operating requirements and intended performance characteristics, and maintain capacity despite a wide variety of external and internal degradation threats, and
- **Operations requirements** that are intended to keep the ship structure within the design performance requirements and loading envelopes.

**Damage tolerance is the design objective most closely associated with structural safety. Durability is the design, construction, and operations objective most closely associated with serviceability.**

Table 3.3 summarizes a comparative evaluation of the relative level of development of the technical aspects of current commercial ASIP and MSIP. Primary aspects needing additional development for advanced MSIP are:

- a) **Structural design information,**
- b) **Structural analyses,**
- c) **Structural testing,**
- d) **Operations structural tracking, and**
- e) **Maintenance tracking.**

### **Design Information**

Improvements in MSIP design information refers to development, documentation, verification, and implementation of a MSIP master plan addressing the life-cycle phases and full-scope operations. Particularly important parts of this plan regard development and detailing of design plans for damage tolerance, durability, and materials.

These plans form the road map for the remaining life-cycle reliability and durability management activities. The plans should include detailing of:

- a) **The life-cycle structural integrity plan (master plan),**
- b) **Design criteria,**
- c) **Damage tolerance plan,**
- d) **Durability development plan,**
- e) **Materials selection and fabrication plan, and**
- f) **Operations plan.**

### **Structural Analyses**

Improvements in MSIP structural analyses refers to development of design guidelines and procedures based on first-principle structure analyses explicitly addressing damage tolerance and durability. This is a next generation of design analyses beyond present classification guidelines and rules.

**The challenges are in selecting appropriate tools to perform the analyses, and in integrating these tools into ship structures design practice in the form of design guidelines and rules.**

At this point, two general observations are in order. **The first is that the primary problems with our current ship structures does not seem to be focused in their overall or "global" capacity characteristics; rather it seems to be focused in their durability characteristics.** Due to the large degrees of redundancy, ductility, and capacity, the overall structural system generally is very robust, i.e., it is very tolerant of localized damage or defects.

**The second observation is that the majority of the durability problems seem to be focused in the need for improvements in design of critical structural details and in improvements in corrosion protection for these details.**

Experience is indicating empirically based, hand-book design, and in some cases analysis based design of critical structural details in mild and high tensile steel construction is not developing sufficiently durable structural systems. Conventional stress range - numbers of cycles to failure (SN) structural analysis procedures have been highly developed in the marine industry and these should be employed in design of critical structural details. Design of many of these details does not recognize the specific construction procedures that will be used to build the ship, and the problems of inspections and repairs (maintenance).

**In some cases, durable design of CSD are compromised to lower the cost of construction. In a highly competitive construction environment and with an owner focused on lowering initial costs, durability is often sacrificed.**

Similarly, experience is indicating that well designed, applied, and maintained corrosion systems can provide the protection necessary for critical structural details. Improvements are needed in coatings and cathodic protection systems, and design of compatible structural - coating systems. The major problems are showing up in improperly designed, applied, and maintained corrosion systems, and incompatibilities between structural and corrosion protection systems (e.g. flexible bulkheads coated with stiff coatings, corrosion cells set up between the parent material and the weld heat-affected zone).

These observations and ship structure inspection and instrumentation constraints emphasize the need for additional development and improvement in two inter-related design aspects:

- **Design for durability, and**
- **Damage and defect tolerant design.**

### Durability Considerations

Developments in design for durability include explicit requirements and procedures for design of critical structural details and systems for:

- Repeated loadings,
- Constructability,
- Inspectability,
- Repairability, and
- Corrosion protection (coatings, cathodic, maintenance).

**The primary objective of design for durability is to create an efficient ship structure devoid of unanticipated costly maintenance and out of service requirements. The extent of design for durability represents a trade-off between initial costs and long-term operating costs. The objective is to make a sufficient initial investment in durability quality to forestall escalation in future maintenance and out-of-service costs.**

Design for repeated loadings (fatigue) is concerned with the reductions in strength and stiffness of the ship structure elements, components (assemblages of elements), and system (assemblages of components). **The basic guideline for such design is if you think you have a fatigue problem, get rid of it; don't try to analyze or maintain it away [3.15].**

Experience indicates that fatigue problems develop because of ignored or inaccurately characterized loadings, poorly designed connections (e.g. inappropriate or no analyses, high stress concentrations, bad load transfer mechanisms), poorly constructed systems, poorly maintained systems (e.g. corrosion allowed to initiate or exacerbate fatigue). Loading and load effects uncertainties generally dominate fatigue analysis uncertainties.

Connections with low stress concentration factors, accurate determination of sustained and cyclic straining histories, use of ductile and fatigue resistant materials (including weldments), robust (damage tolerant) system designs, construction and maintenance quality assurance and control, and perceptive design methods are the key defenses against fatigue damage or low durability structure systems.

Fatigue analyses consist of characterization of short and long term cyclic conditions (loading-unloading, hydrostatic, hydrodynamic, aerodynamic, machinery, equipment) (Fig. 3.19) [3.4], determination of the cyclic forces and strains in the elements that comprise the system, determination of the potential degradation in strength and stiffness of the elements that comprise the system (Fig. 3.20) [3.14], and evaluation of the acceptability of the fatigue design and associated MSIP.

In the drive for weight savings and the associated initial cost savings, many ship structure designs have employed high tensile steel (HTS)

details and components. Test results and experience indicate that it is only in the high stress - low cycle region of fatigue straining where high strength steels have a higher fatigue strength; this region does not contribute much to the total damage [3.12]. Unless the elements have been dramatically under-designed for normal operations and extreme conditions and are subject to very high stresses during normal operations (we have seen some evidence of this in some ship fatigue problems), it is the high-cycle, low-stress region that contributes the majority of fatigue damage. High tensile steel strength (parent material and weldment) is achieved with a cost to fatigue resistance and ductility. As pointed out by recent experience, much more care has to be taken in the design and construction of structural details to minimize stress concentrations when using high tensile steels (HTS) [3.6].

Design for durability includes not only assessment of the effects of repeated loadings as previously discussed, but as well the associated aspects of design for constructability, corrosion protection, inspectability, and repairability. Design for constructability is intended to help assure that the ship structure system that is designed can be effectively (high likelihood of reaching quality objectives) and efficiently (lowest reasonable cost) constructed. This requires that the design and construction procedures and plans be thoroughly and properly integrated.

Design for inspectability is intended to help assure that the ship structure system can be adequately inspected and surveyed, during the construction phase and during the operations - maintenance phase [3.16, 3.17]. The reliability of inspectability is directly connected with the design for repeated loadings. Given that the degree of inspectability of the structural system is low, either during construction or operations - maintenance, then the requirements for defect tolerance (robustness) in the system are increased.

It is here that important questions should be raised concerning how ship structures are presently designed. Designs are focused on creation of minimum weight systems. These emphasize the use of thin plates (to contain cargo and ballast, and exclude sea water) reinforced by a multitude of frames and stiffeners (to provide stiffness and strength). Consideration of design for highly automated fabrication provides important additional constraints on the structural configurations and assemblages.

Perhaps, primary attention needs to be directed to recognition of the very limited degrees of inspectability of the structural system, rather than assuming that inspections can or will be done with a high degree of detection and accuracy. This would tend to constrain the design of the system to use of thicker plates and fewer frames and stiffeners. As noted previously, also this would tend to focus the design of the system on design for durability and defect tolerance.

Design for inspectability should also address provisions to facilitate human access and inspections. Adoption of greater spacings for members to facilitate access, avoiding blind spots in the structural arrangements, and providing access facilities (openings, ladders, walkways, removable staging systems) for entering important parts of the structure. Cleaning, degassing, and lighting systems also need to be provided. In addition, design for inspectability should address development of and provisions for remotely operated inspection systems and instrumentation systems.

Design for repairability should include explicit consideration of how the system can be repaired when there is damage or defects or when the system must be maintained. Too often, in the relative comfort of the design office, it is assumed that the critical structural details can be easily accessed, damaged or defective elements removed, and repairs made. Planning must be done at the design stage on how repairs and maintenance will be done. Again, this requires proper and thorough integration of the repair yard and maintenance objectives and capabilities with the other design objectives.

A key element in design for durability is corrosion protection, particularly for the critical internal structural elements associated with cargo and ballast tanks of crude carriers [3.18]. Experience indicates that the most severe corrosion rates can be expected in ballast tanks. The corrosion effects may be the worst when the ballast tanks are empty or partially full. In this phase, cathodic protection can not protect the metal not covered by water. Cathodic protection efficiency can be reduced by sediment cover in the bottoms of the tanks. Corrosion can be exacerbated by adjacent heated cargo tanks.

Corrosion is also a problem in the cargo tanks. If these tanks are coated, they experience more of the pitting type of corrosion rather than general wastage. If uncoated, general corrosion can be severe in tank bottoms and on stringer platforms. Tank washing and the area under loading line outlets can act to remove coatings and the protection provided by waxy crude cargos. Breakdown of coatings in the under-deck area of cargo tanks can be very severe. Coating breakdowns and partially coated areas can act to accelerate local corrosion.

Coatings and cathodic protection are practical protective measures. Design that eliminates or minimizes traps for water and sediment, and provides scour or erosion protection must be encouraged. Coatings must be properly designed to match the projected expected service and maintenance, and flexibility of the components to be protected. They must be properly applied, cured, and maintained. Similar statements regard the design, installation, and maintenance of cathodic protection systems.

**Robustness Considerations**

Developments in design for damage and defect tolerance include explicit requirements and procedures for design of critical structural details and systems for:

- **Existence of initial primary damage (crack size) based on specified materials and construction quality control procedures,**
- **Existence of continuing damage (crack growth) based on the design loadings, maintenance interval, and in-service inspection quality,**
- **Load path failure or crack arrest, and**
- **Acceptable residual strength.**

In addition, experience indicates that there is a high likelihood that the hull structure can experience damage from collisions, groundings, loading and unloading operations, and explosions and/or fires. Particularly as these hazards can compromise the ability of the hull structure to prevent escape of hydrocarbon cargos, attention should be given to the structural configuration and design aspects to minimize such escape. It will be very important to consider such sources of damage in design of new configurations of tankers.

**The critical structural details and systems for durability and damage tolerance evaluations should be those which contribute significantly to carrying environmental and operational loadings, and whose failure, if undetected, could lead to loss of the ship or its cargo.** Most important in this system is the identification of acceptable or tolerable defects in critical structural elements. This provides an important basis for determining when repairs and renewals must be made.

It is critical that the system for identifying the acceptable or tolerable defects recognize the extent of robustness in the ship structure system. Structural robustness is the integrated effect of redundancy (alternative load paths), ductility (ability of the element, component, and system to maintain load resistance with repeated plastic or nonlinear straining), and excess capacity (ability of elements within the system to fail and transfer their loadings to other under-loaded elements).

It is important to realize that in the past, design for damage and defect tolerance has been implicit in many ship structure design processes. In many cases, this experience based, implicit approach has developed ships with acceptable serviceability and capacity characteristics. Given new ship structural systems, such as some proposed double-hull VLCCs and ULCCs, careful consideration must be given to the related requirements for structural system robustness and durability. Explicit analyses



should be conducted to assure that adequate degrees of robustness and durability are present.

Considerations of both durability and robustness raise the question of where in the structure system these considerations should be focused. This question can be addressed by evaluating the following factors concerning each of the structural elements that comprise a structural component, and the structural components that comprise the structural system:

- a) **Consequences of damage or defects,**
- b) **Likelihood of damage or defects, and**
- c) **Extent of damage or defects.**

If the damage, defects, or absence of a structure element or component leads to a significant compromise of structural integrity (capacity, containment, stability) (Fig. 3.21) [3.13, 3.14], then these elements or components can be classed as **primary critical structure**. If they do not, then they can be classed as **secondary non-critical structure**.

If the likelihood of damage or defects of the primary critical structure elements and components are high, then the requirements for durability and damage tolerance are high. If not, then the requirements for durability and damage tolerance are lower.

Given the expected damage or defects, if the extent of defects and damage (e.g. number of elements and components involved, reductions in capacity and ductility) is extensive, then the requirements for durability and robustness are high. If not, then the requirements for durability and damage tolerance are lower.

It is here that inspectability and repairability of the system are important considerations. If inspections and repairs can be relied upon to limit the likelihood of damage or defects and the extent of damage or defects, then requirements for durability and robustness can be relaxed. If not, then they must be increased to be consistent with the expected or planned degrees of inspectability and repairability.

Table 3.4 summarizes the three principal elements of a comprehensive fracture control approach for ship structures that includes design, fabrication, and operations [3.7]. One of the critical parts of this fracture control approach involves inspections and monitoring of the ship structure design, construction, operation, and maintenance.

### Inspections and Monitoring

A key consideration in adaptation of the technology of ASIP to MSIP regards inspections and inspectability of the two systems (air frames and ship structures). Inspections and monitoring are taken to include the gathering of information and data on:

- **Design (testing, verification),**
- **Construction (materials, fabrication, sea trials),**
- **Operations (loading - unloading, voyage),**
- **Maintenance (disclose damage, assess repairs),**
- **Casualties.**

As summarized in a recently completed Ship Structures Committee sponsored research project on **Guide for Ship Structural Inspections** [3.19]:

**"The purpose of inspections is to assess the capability of the structure to remain safe until the next inspection period and to accomplish any necessary corrective measures to maintain this capability."**

Air frames can be subjected to intensive inspections during their design and production and extensively flight tested to assure the serviceability and capacity of the air frame. While in service, they can be brought into a hangar and subjected to intensive visual and non-destructive testing. Excessively damaged or defective components can be replaced.

Air frames can be extensively instrumented and subjected to extreme conditions to test the adequacy of loading characterizations and response - performance analyses. The air frame environment and structure is very conducive to monitoring and instrumentation. Instrumentation and monitoring systems provide in-flight information to pilots to help avoid compromising operating envelopes. An extensive and formalized accident investigation and reporting system has been developed and implemented.

This is in dramatic contrast with a modern VLCC or ULCC. Such a ship can involve 100 to 200 acres of structural steel surface, and 1,000 to 2,000 miles of welding [3.20]. In contrast with the relatively benign atmospheric environment, these ship structures are operated in an extremely hostile environment of salt water, storm waves, and cargos of liquid - gas hydrocarbons.

To subject all of the steel and welding in a VLCC or ULCC to intensive visual and non-destructive testing during construction would not be practical; time and costs would be prohibitive. Sea trials rarely are of a du-

ration or intensity severe enough to disclose critical design or construction flaws.

**During construction, the first line of inspections for quality assurance and control is training and qualification of the construction personnel. The second line is the provision of positive incentives and resources (adequate working conditions and equipment) for high quality workmanship. The third and last line is the use of inspectors and spot-checking NDT equipment.**

During maintenance operations, detailed inspections are even less practical compared with inspections during construction.. Access and lighting are extremely limited in performing inspections of critical internal structural details. Due to darkness, water, dirt (sediment in bottom of ballast tanks and coating structure elements), and residual accumulations of hydrocarbons, inspections are hazardous [3.18-3.20].

Table 3.5 [3.21] summarizes the advantages and disadvantages of tank inspection techniques that are presently being used by owner - operators. The evaluation assumes that the tanks and critical structural details to be inspected have been cleaned and that the tanks are gas free and safe for personnel entry. Aided and unaided visual techniques are the primary inspection technique.

Gaging surveys are difficult to perform because of the problems associated with obtaining accurate thickness measurements, accurately determining the locations of the measurements, recording the measurements, and evaluating the data. Corrosion pitting surveys are similarly difficult and involve a high degree of subjectivity. Inspector experience and training vary widely; thus, the quality of inspections also vary widely.

Marine accident reporting and investigating systems have been developed, but need continued development. Accident investigators need to be qualified and properly trained. These investigators must be given a procedural system that will guide their investigations, and a data recording system that will permit the results to be efficiently archived and retrieved for analysis and evaluations.

**While improvements in ship design and inspection methods and equipment are possible and should be encouraged, it does not appear to be reasonable to expect that ASIP inspection methods and reliabilities can be simply extrapolated to MSIP. At the present time and in the near future, current ship inspection methods and programs should be relied on only to disclose very major or obvious defects and damage to critical structural elements. Practical limitations on inspections and inspectability of ships places important and significant constraints on the other portions of MSIP.**

Similarly, the use of instrumentation and performance monitoring systems are more severely restricted in the ship environment.

**Instrumentation transducers and leads have very limited durabilities in this environment. While improvements in instrumentation and monitoring equipment and systems are certainly possible and should be encouraged, practical limitations on present instrumentation and monitoring of ships places important and significant constraints on other portions of advanced MSIP.**

**The major implications for MSIP concerns the basic design of the critical structural elements, components (assemblages of elements), and system. The ship structure system must be designed so as not to rely on accurate inspections. Inspections should be one means of helping assure a given level of minimum quality, durability, and strength in the structural system.**

**This places a heavy burden on the design, construction, and maintenance of the structural system; it must be designed, constructed, and maintained to be durable and robust (damage and defect tolerant), fundamentally independent of reliance on highly accurate inspections and monitoring. Steel, and high quality design and construction are used in lieu of more sophisticated high quality inspection based maintenance procedures. Future developments in inspection systems may allow use of more economic durability, robustness, and maintenance approaches.**

### **Structural testing**

Improvements in MSIP structural testing refers to intensified requirements for element and component laboratory testing to demonstrate damage tolerance, durability, adequacy of repairs, and veracity of analytical models for critical structural elements and components. Ship design has largely progressed on the basis of experience. Testing has been done largely with in-service observations and experience.

**Much more definitive testing data needs to be developed on the durability characteristics of the present generation of critical ship structural details and on the durability characteristics of repairs to such details. This information will provide much needed background to calibrate analytical models and to provide insight into the acceptability of defects and damage that are discovered during the course of construction and maintenance inspections.**

Structural testing should be focused first on new (no existing definitive test data) critical internal structural details (connections) and include:

- a) Static tests to demonstrate capacity and ductility,**
- b) Durability tests to demonstrate adequate fatigue strength,**

**c) Damage tolerance tests to demonstrate inspectability and limits of damage to develop acceptable residual strength and ductility.**

Structural testing should be focused second on scale testing of assemblies or components that are comprised of new critical internal structural details. As for the single elements or details, the components or assemblies tests should include static, durability, and damage tolerance tests.

### **Structural Tracking**

Improvements in MSIP operations structural tracking refers to intensified deployment of instrumentation and monitoring systems to determine loadings, response, and performance characteristics of critical structural elements while the ship is in service. Additional development efforts need to be focused on development of practical and robust ship structure instrumentation systems.

Uncertainties in loadings (environmental, operating) constitute one of the largest sources of uncertainties in ship structural reliability and durability. A primary objective of instrumentation systems is to help reduce loading uncertainties. A second objective of instrumentation systems is to provide data to validate structural response and performance analysis models. Because of the dramatic influences of crew operations on both ship loadings and ship structure performance, monitoring systems can provide important information to indicate when operating envelopes are being exceeded.

Large uncertainties in loadings and performance result in the need for large factors of safety to achieve a given level of reliability and durability. Large uncertainties frequently result in unexpected durability problems and out-of-service time. **Thus, uncertainty costs. Experience with a variety of marine structures indicates that the knowledge that can be gained from well conceived instrumentation and in-service monitoring programs can result in significant cost (initial and/or future) reductions.**

### **Maintenance Tracking**

Improvements in MSIP maintenance tracking refers to development and implementation of a life-cycle, full scope, industry sector wide integrated computer based system for archiving, analyzing, and tracking ship structure performance characteristics.

**Such a system is intended to provide a long-term corporate memory to reflect on the adequacy of design, construction, and maintenance practices, and to alert the responsible parties to important symptoms of ship structure problems.**

The system should include tabular and graphical data bases. Table 3.6 defines the essential contents of these data bases.

It is important that the data bases have graphical components that are easily linked to the tabular data components. Future developments could include analytical packages (engineering, economics) that would facilitate maintenance decisions and procedures.

### Structural System Reliability and Economy

As noted earlier, a fundamental objective of MSIP is to establish and develop a desirable level of structural reliability (integrity and durability) in new ships, and then to maintain that reliability at acceptable levels.

This objective is subject to two important inter-related and complementary constraints. The first constraint can be identified as the required or desired "standards of performance" for the newly constructed ship structure and for operations and maintenance of the ship structure during its life. These standards can be expressed in qualitative and quantitative terms.

Experience and historical data on the performance of ship structures and comparable structural or engineered systems can be used as a basis for determining these standards. Such a historical - experience based evaluation is shown in Fig. 3.18 [3.11, 3.12, 3.15]. This figure shows reliability (expressed as the annual probability of failure due to all causes) of various types of engineered structures versus the general range of consequences associated with the failures (expressed in 1984 dollars, and lives lost). It is important to note that on the basis of these data, **both acceptable and marginal combinations of reliability and consequences have been characterized.**

Potential time variability in the standards must be recognized if reasonable guidelines are to be developed to cover the projected life-time and area of operations for the ship structure. These variations (generally reductions) reflect the percentage of the population involved in the activities. It is recognized that societal and political factors can weigh heavily in determining the requirements for reliability. The standards for reliability generally reflect the regulatory requirements for conduct of operations of the system [3.11, 3.12].

The second constraint can be identified as a search for the ship structure system and MSIP that can result in minimum expected life cycle costs associated with that structure (Fig. 3.22) [3.22]. This search can be expressed alternatively as a search for the ship structure system that will have the highest life-cycle utility.

This is essentially a problem in balancing quality and reliability with present and future costs or utilities. Costs, generally expressed in monetary terms, reflect the value of goods and services involved with the activity. Utility is another of expressing the same thing, but in non-dimensional terms (like normalized dollars) [3.15].

Present costs include all of the costs associated with the design, construction, and commissioning of the ship structure. Future costs include all of those costs associated with operations, maintenance, and loss of serviceability. Loss of serviceability costs can range from those associated with down-time and loss of income due to the down-time to catastrophic loss of serviceability costs associated with complete loss of the ship and cargo.

Higher reliability (capacity - durability - robustness) structure systems have higher initial costs (Fig. 3.17) [3.15]. Conversely, they have lower expected future costs due to less maintenance and loss of serviceability costs. The search is focused at defining that ship structure system and MSIP that can result in the minimum total expected cost.

An application of the first and second constraints to design of alternative ship structures and MSIP is illustrated in Fig. 3.23 [3.13, 3.14]. It is possible to design a maintenance-free ship structure that does not require renewal of steel, coatings, and anodes through its life (illustrated here as 20 years). Similarly, it is possible to design a ship structure according to traditional design rules and maintain the ship through renewal of coatings, anodes and steel.

The point that defines the steel requirements for the traditional newly commissioned ship is an expression of the desirable reliability for the ship structure. The point below which steel renewals are mandated represent the minimum acceptable reliability for maintenance of the ship. It is at these two points that the "standards of performance" constraint comes into effect.

Note that the maintenance-free ship effectively loses steel through corrosion and fatigue damage (structural degradation), but it remains above the minimum acceptable steel level. The traditional design ship is subject to inspections and maintenance (steel renewals) throughout its life. The rate of structural degradation after renewals can be higher than before. Each of these strategies has different initial and future costs.

**The determination of what constitutes a "best" MSIP depends not only on the minimum total expected cost evaluation, but as well, on a wide diversity of complex factors such as the availability of capital to purchase the ship, operating capital to maintain the ship and income that can provide the financial basis for purchase and operating capital.**

---

**Organizational Developments**

---

The single largest challenge to realizing an advanced MSIP is related to the culture and organization of this industry, its financial well being, and the global nature of its activities.

The primary objective of advanced MSIP is the improvement of the durability characteristics of crude carriers; to reduce the incidence of unanticipated maintenance costs. The primary objective of advanced MSIP is not improvements in life and cargo safety.

Experience indicates that in the case of crude carriers life and cargo safety concerns are not basically related to life-cycle structural integrity; they are primarily related to the vessel equipment and operating (human) aspects. Resources invested to improve vessel management systems; crewing, training, and licensing systems; vessel routing and traffic systems; and navigation, steering, and maneuvering systems can yield major benefits in improving life and cargo safety.

This is a somewhat different challenge than addressed by ASIP. In the case of airframes, structure durability and public life - cargo safety aspects are intimately related to each other. Integrity of the airframe and its durability have major implications with regard to the ability of this structure to meet its primary safety requirements. The ASIP technical and organization system has been configured to address these special aspects.

This background indicates that the resources required to implement advanced MSIP should be justified on the basis of improving the life-cycle economics associated with tanker operations. Thus, MSIP should address the organizational developments that can lead to more effective and efficient life-cycle and full-scope ship integrity programs. These issues address how the organizational sectors of the industry can work more effectively toward a common set of advanced MSIP goals. These organizational segments should include:

- a) Regulatory Agencies,**
- b) Classification Societies,**
- c) Manufacturers, designers, builders, and repairers, and**
- d) Owners and operators.**

In the case of ASIP, the FAA, the U. S. aircraft manufacturers, and the U. S. operators exert dominant and controlling influences on the world wide industry of commercial air transport. This is a very different situation than for the U. S. based crude carrier industry. In this case, the world wide organization is much more diffuse; it is based outside the U. S. The



organizational developments required to realize an advanced MSIP are much more difficult to achieve.

Perhaps the U. S. based ship industry can help take the lead in a world-wide effort to institute advanced MSIP based on the premise of improving the life-cycle economics of the transport of crude oil and refined products. Efforts by owners and operators (e.g. Tanker Structure Co-operative Forum, TSCF), Classification Societies (International Association of Classification Societies, IACS), and regulatory bodies (International Maritime Organization, IMO) have been initiated in this direction. In addition, some insurance groups have begun to structure premiums to recognize high quality MSIP.

One of the primary organization implications of advanced MSIP regards the continuation of the industry's heritage of individual custom designed ships. Given the increased demands of design, testing, and construction to achieve durable CSD and ship framing systems (and the costs and time associated with this activity), such custom designs would not seem to be in the industry's best interests. Advanced MSIP would implicate the development of fewer basic classes of ship structural systems. Benefits could include (suggested by John Balczewski):

- Shipyards would have fewer classes of ships to build, so they could improve their quality and knowledge of costs; construction efficiencies would become a primary objective.
- Classification Societies would have fewer plans to study, resulting in better plan review, better quality assurance and inspection activities, and easier tracking of maintenance histories.
- Owners would benefit from having well-analyzed ships being built in yards that have built them before; the vessel resale and charter markets would also benefit because of the better defined durability and maintenance characteristics of the ships.
- Ship designers would have fewer ship structure framing systems and CSD to address, improvements in designs, verifications of improvements in designs, and reductions in design times and costs would become primary objectives.
- Ship insurers and financial institutions would be able to better analyze the risks, and premiums when asked to finance or insure a ship or cargo.
- Regulatory groups would be able to better focus the definition of advanced MSIP goals and responsibilities; the communication system to gather, archive, and analyze MSIP successes and failures would be facilitated.

---

## **Marine Structural Integrity Programs**

---

Based on the background developed during this project, Table 3.7 summarizes the author's comparative evaluation of the general current levels of development of the organizational aspects of commercial ASIP and MSIP. This evaluation has been made relative to the degree of sophistication needed to develop and maintain the structural integrity of the two very different systems (air frames and ship structures). The evaluation includes a synthesis of the regulatory, classification, production, and operations segments of both industries (commercial airplanes and commercial ships).

Five primary aspects are indicated as needing additional development for advanced MSIP:

- a) Verification,**
- b) Training,**
- c) Staffing,**
- d) Information systems, and**
- e) Communications systems.**

Critical in these developments are:

- a) Provision of a system of positive economic incentives and accountability that will encourage allocation of industry-wide (regulatory agencies, classification societies, owners/operators, and manufacturers) resources to advanced MSIP,**
- b) Reduction of industry-wide drag in the initiation and conduct of advanced MSIP operations and development of MSIP programs, and**
- c) Founding the MSIP organizational system on integrity and trust so that it can minimize dissipating litigation and liability concerns.**

### **Goals and Responsibilities**

Of particular importance in MSIP developments is agreement between the principal sectors of the goals and responsibilities of each sector. Based on comparable ASIP organizational developments, MSIP responsibilities for each of the four segments is suggested as follows:

- 1) Regulatory - responsible for definition and verification of compliance with goals and policies of MSIP,**
- 2) Classification - responsible for development of classification rules that will guide and verify design, construction, and operation of**

**durable and reliable ship structures that meet regulatory requirements,**

**3) Manufacture - responsible for designing and producing a vessel with appropriate seaworthiness, structural integrity, and durability, and**

**4) Operations - responsible for design and maintenance of ships and the safe and economic operation of the vessels.**

Table 3.8 summarizes suggested organizational and technical responsibilities of each of the groups in development of advanced MSIP.

There must be a long-term commitment to the integrity of MSIP and provision of resources required to perform MSIP. Long-term profitability (income exceeds costs) by all sectors is required if the resources required for improved MSIP are to be available.

**The MSIP organizational developments should promote intensely communicative cooperative and supportive interactions among the major segments of this industry.** The organizational developments must be based on continuous proactive structural integrity management that involves control or verification of adequacy of the process and of the performance of the process. The organizational developments must promote a disciplined and structured approach to MSIP.

**MSIP organizational developments should result in the ship structure achieving a degree of reliability and durability that is acceptable to the sectors responsible for ship operations.** Reliability and durability are achieved at a cost. Reliability and durability should be in balance with the risks or hazards associated with the particular type of ship operations. Risks reflect the likelihood of accidents and the potential consequences of those accidents. Higher risk operations imply the need for higher levels of reliability. Durability problems can be reflected in both unanticipated maintenance costs and degradations in the capacity of the ship structure.

**Profitability from the ship operations must provide the financial resources required to achieve the degree of reliability and durability that is deemed desirable or acceptable.** All of these organizational measures to improve MSIP cost money, time, and effort. The consumer and general public must be willing to pay for the improvements required to increase the reliability and safety of this segment of commercial transportation. The regulatory, owner - operator, and producer segments of this industry must agree on the extent of development of MSIP appropriate to assure the reliability and durability of a particular class of ship operations.

---

## **Research and Development**

MSIP should address high priority research and development (R&D) efforts that should be undertaken to continue improvement and evolution of MSIP. High priority R&D developments should include:

- a) Development and verification of definitive durability and damage tolerance engineering guidelines and procedures for critical elements of ship structure systems;**
- b) Development and verification of efficient and effective inspection and monitoring systems and performance guidelines for construction, in-service, and maintenance / repair periods; and**
- c) Development and implementation of a computer based database MSIP information system.**

### **Summary**

---

This chapter has summarized the principal technical and organizational components that should be considered in development of advanced MSIP.

The principal technical components addressed regard procedures and processes to improve design, construction, and maintenance for durability. The basic components of an MSIP database information system have been defined.

The principal organizational components addressed regard procedures and processes to improve the incentive, integrity, efficiency, effectiveness, and communications aspects that are vital to development and implementation of advanced MSIP.

The technology required to develop and implement a next-generation, practical, and advanced MSIP exists. High priority research and development efforts that are needed to allow efficient and effective implementation of advanced MSIP include improvements in procedures and processes for design, construction, maintenance, and inspections to assure durability, and development of a computer based MSIP information system.

The remainder of this report will address the key technical developments that are needed to allow implementation of advanced MSIP for crude carriers.

---

**References**

---

- [3.1] Ohyagi, M. (1987). *Statistical Survey on Wear of Ship's Structural Members*. NK Technical Bulletin; also *Statistical Survey on Wear of Ship's Structural Members by Thickness Measurement Data*. Research Institute of Nippon Kaiji Kyokai (1983).
- [3.2] International Ship & Offshore Structures Congress (1985). *Proceedings of the Ninth International Ship Structures Congress*, Genova, Italy.
- [3.3] Ferguson, J. (1989). *Extending the Life of Existing Tanker Hulls: Structural Trends in Today's Tanker Newbuildings, The Lloyd's Register Forum on Crude Oil Carriers in the 1990s*, London, England.
- [3.4] International Ship & Offshore Structures Congress (1988). *Proceedings of the Tenth International Ship & Offshore Structures Congress*, Lyngby, Denmark.
- [3.5] Lloyd's List (1990). *MHI Recalls Tankers*, Sept 7.
- [3.6] Nippon Kaiji Kyokai (1990). *Experience Presentation with VLCC*, report to Tanker Structure Co-Operative Forum.
- [3.7] Stambaugh, K. A. and Wood, W. A. (1991). *Part 1 - Ship Fracture Mechanisms Investigation*. Ship Structure Committee Report SSC-337.
- [3.8] United States Coast Guard (1989). *Report of the Tanker Safety Study Group*, U. S. Dept. of Transportation, Washington, D.C.
- [3.9] Purtell, T.W., Mielke, T.C., and Brusseau, J.P. (1988). *Marine Structural Casualty Study*, Report to the Marine Inspection Program Casualty Review Council, U.S. Coast Guard, Washington, D.C.
- [3.10] Bea, R. G. (Editor) (1990). *Proceedings of the Sea Grant Symposium on Preservation of Ageing Marine Structures*, Univ. of Cal. at Berkeley.
- [3.11] Baxter, J., Cojeen, H. P., Bowen, M., Thyamballi, A., and Bea, R. G. (1990). *An Approach to the Evaluation of Service Life, Proceedings of the International Conference on Integrity of Offshore Structures IOS'90*, Glasgow, U.K.
- [3.12] Skaar, K. T., Aage, C., Ashe, G. M. Babinet, J., Bea, R. G., Clarke, J. D., Gnone, E., and Nitta, A. (1991). *Inspection, Monitoring, Maintenance / Repair. Proceedings of the 11th International Ship and Offshore Structures Congress*, Report of Committee V.2, China.

- [3.13] Skaar, K. T., Sverre Valsgård, Köhler, and Mürer (1987). *How Low Can Steel Weight Go with Safety and Economy? Proceedings, Third Int. Conference on Practical Design of Ships and Mobile Offshore Units, PRADS' 87*, Trondheim, Norway.
- [3.14] Köhler, P. E. and Valsgård, S. (1987). *Advanced Ship Structural Design and Maintenance, Proceedings, Third Int. Conference on Practical Design of Ships and Mobile Offshore Units, PRADS' 87*, Trondheim, Norway.
- [3.15] Bea, R.G. (1991). *Reliability Based Fatigue Design Criteria for Coastal and Ocean Structures (Chapter 4), Reliability Based Design Criteria for Coastal and Ocean Structures*, Institution of Engineers Australia, Barton, ACT.
- [3.16] Ferguson, J. M. (1991). *Some Considerations Regarding Tank Inspection Priorities for Oil Tankers. Proceedings, Marine Structural Inspection, Maintenance and Monitoring Symposium*, Arlington, Virginia.
- [3.17] Bureau Veritas (1987). *Inspection Procedures and their Influence on Tanker Design*. Report to the Tanker Structure Cooperative Forum.
- [3.18] Tanker Structure Co-operative Forum (1986). **Guidance Manual for the Inspection and Condition Assessment of Tanker Structures**. International Chamber of Shipping Oil Companies International Marine Forum, Witherby & Co. Ltd., London, 1986.
- [3.19] Basar, N. S., and Jovino, V. W. (1991). *Guide for Ship Structural Inspections*, Ship Structure Committee Report No. SSC- 332.
- [3.20] Weber, P.F. (1984). *Structural Surveys of Oil Tankers*, Exxon Paper Presented at Joint Meeting Institute of Marine Engineers and Royal Institution of Naval Architects, Transactions, Institute of Marine Engineers, Vol. 96.
- [3.21] Witmer, D. (1990). *Tank Inspection Methods and Techniques*. Presentation to Committee on Marine Vessel Corrosion, National Association of Corrosion Engineers, NACE Technical Committee T-14B, Denver, Colorado.
- [3.22] Kristoffersen, K., and Brakas, M. J. (1986). *Methodology and Computer Analysis for Optimization of Maintenance, Proceedings of the Asian Maintenance Management Conference*, Singapore.

**Table 3.1 - Relative Frequency (Percentage) of Damage to Major Structural Hull Members and Type of Ship *For All Categories* of Ships and Damage**

Kind of Ship	Gen. Cargo	Oil Tank	Bulk Carr.	Gen. & Lumber	Ore Carr.	LPG Carr.	Container Carr.	Cargo Carr.	Other Ships
Ratio of Dam.	11	19	9	26	9	2	1	3	20
Type Stru. Mem.									
Up. Deck	2.3 2.0	1.9 1.7	1.0 0.7	7.0 4.8	1.0 0.8	0.4 0.4	0.2 0.0	0.2 0.0	3.0 1.6
Side Shell	5.0 3.8	3.0 1.2	3.2 2.5	9.4 6.4	2.3 1.4	0.4 0.1	0.3 0.1	0.5 0.1	5.2 2.9
Bott. Shell	1.1 0.2	3.6 0.7	1.2 0.5	2.6 0.4	0.7 0.4	0.1 0.0	0.1 0.0	1.0 0.0	3.8 1.1
Bulk head	1.5 1.0	10.1 5.7	0.9 0.5	4.1 1.6	5.0 3.0	0.1 0.0	0.2 0.0	0.8 0.1	4.0 2.0
Other	1.1 0.5	0.4 0.3	2.7 1.7	2.9 1.0	0.1 0.0	1.0 0.2	0.2 0.0	0.5 0.0	4.0 2.3

**Table 3.2 - Relative Frequency (Percentage) of Damage to Major Structural Hull Members and Type of Ship *For Specific Categories* of Ships and Damage**

Kind of Ship	Gen. Cargo	Oil Tank	Bulk Carr.	Gen. & Lumber	Ore Carr.	LPG Carr.	Container Carr.	Cargo Carr.	Other Ships
Ratio of Dam.	11	19	9	26	9	2	1	3	20
Type Stru. Mem.									
Up. Deck	21 85	10 90	11 72	27 68	11 82	20 94	24 0	7 0	15 52
Side Shell	45 77	16 38	36 76	36 68	25 62	20 26	34 14	15 15	26 56
Bott. Shell	10 19	19 20	13 43	10 17	8 54	7 18	12 0	34 0	19 29
Bulk head	14 68	53 57	10 59	16 38	55 64	4 14	15 11	26 15	20 51
Other	10 45	2 68	30 63	11 35	1 29	49 21	15 26	18 0	20 58

**Table 3.3 - Comparative Evaluation of Development of Technical Aspects of Current ASIP and MSIP**

<b>TECHNICAL ASPECT</b>	<b>ASIP</b>	<b>MSIP</b>
<b>Structural Design Information</b> - Master Plan - Design Criteria - Damage Tolerance - Durability - Materials - Operations	High	Low to Moderate*
<b>Structural Analyses</b> - Loadings - Serviceability - Capacity - Damage Tolerance - Durability	High	Moderate to Low*
<b>Structural Testing</b> - Static Capacity - Durability - Damage Tolerance - Prototype Trials - Evaluations	High	Low*
<b>Operations Structural Tracking</b> - Loadings - Performance - Monitoring	High	Low*
<b>Maintenance Tracking</b> - Inspections - Programming - Recording - Repairs - Replacements - Evaluations	High	Low*

\* Primary aspects needing additional development for advanced MSIP



**Table 3.4 - Fracture Control Approach for Ships****I. Design Goals: Specification of Strength & Fracture Resistance Properties**

- A. Determine / estimate stress distribution and related information (including operational temperatures, strain rates) and determine regions of greatest fracture hazard.
- B. Specify materials strength properties, fracture properties, recommended heat treatments.
- C. Determine flaw tolerance in regions of greatest fracture hazard.
- D. Recommend fabrication procedures, welding methods, and allowable flaw sizes.
- E. Estimate stable crack growth for typical periods of service.
- F. Recommend safe operating conditions for specified intervals between inspection from the results of A - E. This may be ship specific or ship class specific based on the first few years of service and may be greatly influenced by building yard, area of operations, etc.

**II. Fabrication Goals: Protection of Specified Strength and Fracture Properties**

- A. Develop controls for residual stress, grain coarsening, grain direction.
- B. Inspect prior to final assembly.
- C. Inspect defects using appropriate non-destructive (ND) evaluation techniques at specified times after fabrication (welding).
- D. Maintain fabrication records.

**III. Operations Goals: Maintenance of Strength Parameters**

- A. Control the stress level and stress fluctuations in service.
- B. Maintain corrosion protection systems.
- C. Perform periodic in-service inspections as specified in I - F.
- D. Monitor growth of subcritical flaws.
- E. Repair or renew affected areas.

**Table 3.5 - Summary of Advantages and Disadvantages of Alternative Tank Inspection Methods**

<b>ALTERNATIVE</b>	<b>ADVANTAGES</b>	<b>DISADVANTAGES</b>
<b>Walking the bottom - Close-up inspection of accessible structure without climbing</b>	<ul style="list-style-type: none"> <li>• Allows close-up visual inspection by all parties</li> <li>• Allows detailed documentation</li> <li>• No set-up time required</li> <li>• Highly accessible for repairs</li> </ul>	<ul style="list-style-type: none"> <li>• Limited to the tank bottom</li> </ul>
<b>Binoculars with high-intensity lights</b>	<ul style="list-style-type: none"> <li>• Easy to conduct</li> <li>• Accepted by regulatory groups and classification societies (?)</li> </ul>	<ul style="list-style-type: none"> <li>• Not a reliable procedure</li> <li>• Cannot see close-up</li> </ul>
<b>Physical climbing without restraint</b>	<ul style="list-style-type: none"> <li>• Allows visual inspection of some details</li> </ul>	<ul style="list-style-type: none"> <li>• Safety is compromised</li> </ul>
<b>Physical climbing with fall safety devices</b>	<ul style="list-style-type: none"> <li>• Allows close-up inspections of side shell structure</li> <li>• Provides proven degree of safety</li> <li>• Minimal set-up time</li> </ul>	<ul style="list-style-type: none"> <li>• Physically demanding</li> <li>• Difficult to record findings</li> <li>• Underdeck structure not accessible</li> </ul>
<b>Staging</b>	<ul style="list-style-type: none"> <li>• Allows close-up inspection of all structure by all parties</li> <li>• Allows detailed documentation</li> <li>• Provides accessibility for repairs and follow-up inspection</li> </ul>	<ul style="list-style-type: none"> <li>• Cost is high</li> <li>• Set-up and break-down time is long</li> <li>• Risks of falling planks, etc.</li> </ul>
<b>Mechanical devices</b>	<ul style="list-style-type: none"> <li>• Allows close-up inspections</li> <li>• Allows detailed documentation</li> </ul>	<ul style="list-style-type: none"> <li>• Set-up, break-down time is long</li> <li>• Awkward to rig and handle equipment</li> <li>• Typically accommodate only one person at a time</li> <li>• Cost is high</li> </ul>
<b>Rafting</b>	<ul style="list-style-type: none"> <li>• Allows close-up inspection</li> <li>• Allows detailed documentation</li> <li>• Eliminates risk of falling</li> </ul>	<ul style="list-style-type: none"> <li>• Underdeck structure basically inaccessible due to depth of webs</li> <li>• Time consuming</li> <li>• Must ballast ship</li> </ul>

**Table 3.5 - Summary of Advantages and Disadvantages of Alternative Tank Inspection Methods**

ALTERNATIVE	ADVANTAGES	DISADVANTAGES
<b>Divers</b>	<ul style="list-style-type: none"> <li>• Allows close-up inspections</li> <li>• Good documentation (video, photographs, etc.)</li> <li>• Can perform NDT underwater (accessibility)</li> </ul>	<ul style="list-style-type: none"> <li>• Requires divers with good knowledge of ship's structure</li> <li>• Must ballast ship</li> <li>• Time consuming</li> <li>• High cost</li> </ul>
<b>Remote Operated Vehicles (ROVs)</b>	<ul style="list-style-type: none"> <li>• Allows close up inspections</li> <li>• Can perform video and NDT work</li> <li>• All parties can watch on monitor or view video recordings</li> </ul>	<ul style="list-style-type: none"> <li>• Low reliability</li> <li>• Easy to become disoriented</li> <li>• Time consuming</li> <li>• Field of vision limited</li> <li>• Requires topsides support staff</li> <li>• Must ballast ship</li> <li>• High cost</li> </ul>
<b>ROVs with diver support</b>	<ul style="list-style-type: none"> <li>• Refer to divers and ROVs</li> </ul>	<ul style="list-style-type: none"> <li>• Refer to divers and ROVs</li> </ul>
<b>Periscopes and borescopes</b>	<ul style="list-style-type: none"> <li>• Close-up inspection via deck openings</li> </ul>	<ul style="list-style-type: none"> <li>• Developmental</li> </ul>
<b>Permanent in-tank catwalks, walkways, ladders, etc.</b>	<ul style="list-style-type: none"> <li>• Allows close-up inspections by all parties</li> <li>• Allows good documentation</li> <li>• Easy access</li> </ul>	<ul style="list-style-type: none"> <li>• Cost is high</li> <li>• Additional structure which must be maintained (corrosion protection, cleaned prior to use)</li> </ul>

**Table 3.6 - Summary of Tabular and Graphical MSIP Database Components**

<b>MSIP PLANS</b> Design Construction Operations Inspections, Monitoring, Maintenance, Repairs
<b>DESIGN INFORMATION</b> Design Criteria Rules Materials & Fabrication Loading Analyses Stress Analyses Damage Tolerance Analyses Durability Analyses Design Development Test Program Monitoring Program Development Classification Program Design Documentation Design Drawings
<b>CONSTRUCTION INFORMATION</b> Specifications Builder Quality Assurance & Control Procedures Quality Assurance & Control Reports Inspections Design Variances As-built Drawings
<b>OPERATIONS INFORMATION</b> Voyages Cargos Ballasting Procedures Cargo Loading and Unloading Procedures Cleaning Monitoring Results Accidents
<b>MAINTENANCE INFORMATION</b> Cleaning Coating Repairs Cracking Repairs Steel Renewals
<b>INSPECTION AND MONITORING DATA</b> Corrosion Survey Reports Cracking Survey Reports Monitoring Program Reports
<b>REPAIR INFORMATION</b> Coating Repairs and Maintenance Cathodic Protection Repairs and Maintenance Fracture Repairs Steel Renewals

**Table 3.7 - Comparative Evaluation of Organizational Aspects of Current ASIP and MSIP**

ASPECT	ASIP	MSIP
Goals and Responsibilities	High	Moderate*
Guidelines	Moderate to High	Moderate
Procedures	High	Moderate
Verification - Concept - Design - Construction - Operations - Maintenance	High	Moderate to Low*
Training - Regulatory - Production - Operations	High	Moderate to Low*
Staffing - Regulatory - Production - Operations	High	Low*
Information Systems	Moderate to High	Low*
Communication Systems	Moderate	Low*

\* Primary aspects needing additional development for advanced MSIP

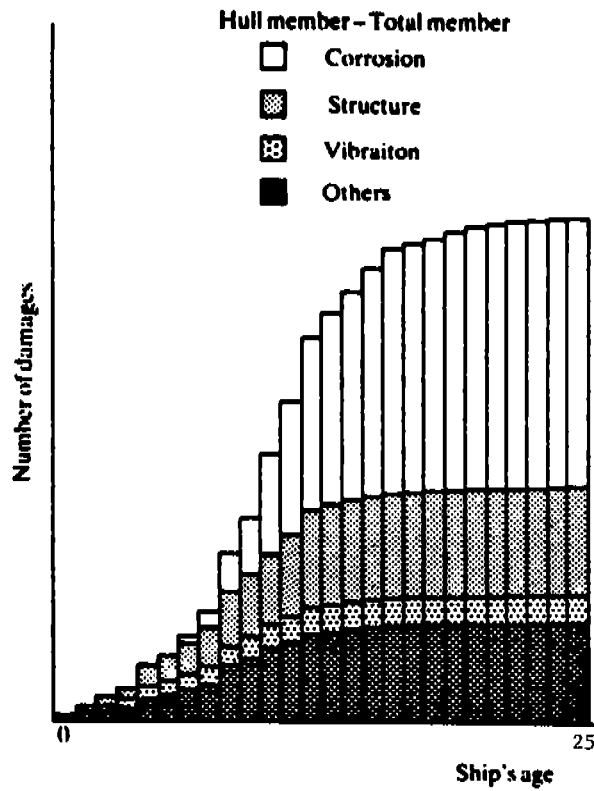
**Table 3.8 - Suggested Organization Responsibilities for MSIP**

<b>SEGMENT</b>	<b>RESPONSIBILITIES</b>
<b>Regulatory</b>	<ol style="list-style-type: none"> <li>1) Develop and issue technical standards and regulations.</li> <li>2) Perform, evaluate, and report results of design and production reviews and inspections.</li> <li>3) Perform, evaluate, and report results of operations and maintenance inspections.</li> <li>4) Archive, review, analyze data, and disseminate information from inspections, repairs, information requests, and field operations reports.</li> <li>5) Provide information feedback to the responsible Classification, owners - operators, and builders - repair yards.</li> <li>6) Help develop and recommend ship structure design, inspection, and maintenance improvements.</li> </ol>
<b>Classification Society</b>	<ol style="list-style-type: none"> <li>1) Assist in developing and issuing technical standards and regulations.</li> <li>2) Assist Regulators and Operators in performing, evaluating and reporting the results of design and production reviews and inspections.</li> <li>3) Assist Regulators and Operators in performing evaluating, and reporting results of operations and maintenance inspections.</li> <li>4) Assist Regulators and Operators in archiving, reviewing, analyzing ship MSIP data, and disseminate information from inspections, repairs, information requests, and field operations reports.</li> <li>5) Assist Regulators and Operators in providing information feedback to the responsible Classification, owners - operators, and production organizations.</li> <li>7) Help develop and recommend ship structure design, inspection, and maintenance improvements.</li> </ol>

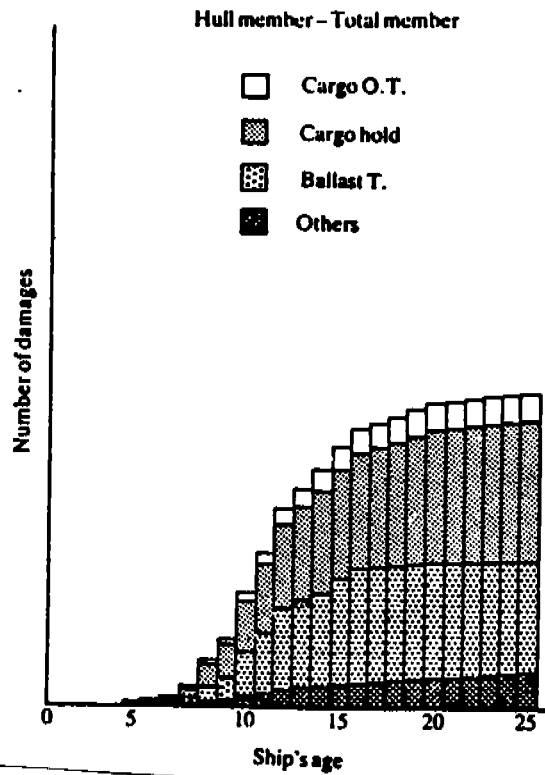
**Table 3.8 - Suggested Organization Responsibilities for MSIP**

SEGMENT	RESPONSIBILITIES
<b>Ship Operators - Owners</b>	<ol style="list-style-type: none"> <li>1) Operate and maintain ships within intended operating conditions.</li> <li>2) Develop approved standard MSIP including inspection and maintenance programs.</li> <li>3) Perform continuing inspection and maintenance.</li> <li>4) Conduct special structural integrity and durability inspections, repairs, and modifications.</li> <li>5) Review and analyze data from inspections, repairs, information requests, and field service reports.</li> <li>6) Provide information feedback to the responsible regulatory and production organizations, and other operators.</li> <li>7) Develop and recommend ship structure design, inspection, and maintenance improvements.</li> <li>8) Perform continuing liaison with regulatory and manufacturing organizations.</li> </ol>
<b>Ship Manufacture and Repair Yards</b>	<ol style="list-style-type: none"> <li>1) Develop and design ships and MSIP to meet or exceed industry, regulatory, and classification society standards and requirements.</li> <li>2) Produce ships that meet or exceed industry, regulatory, and classification society standards and requirements.</li> <li>3) Recommend preventative maintenance and modification programs.</li> <li>4) Recommend minimum standard inspections.</li> <li>5) Recommend special inspections, and modifications.</li> <li>6) Supply information experience from production, inspections, and maintenance of ships.</li> <li>7) Develop ship design and maintenance improvements.</li> <li>8) Perform continuing liaison with regulatory and owner/operator organizations.</li> <li>9) Seek and employ operational feed-back</li> </ol>

# Marine Structural Integrity Programs

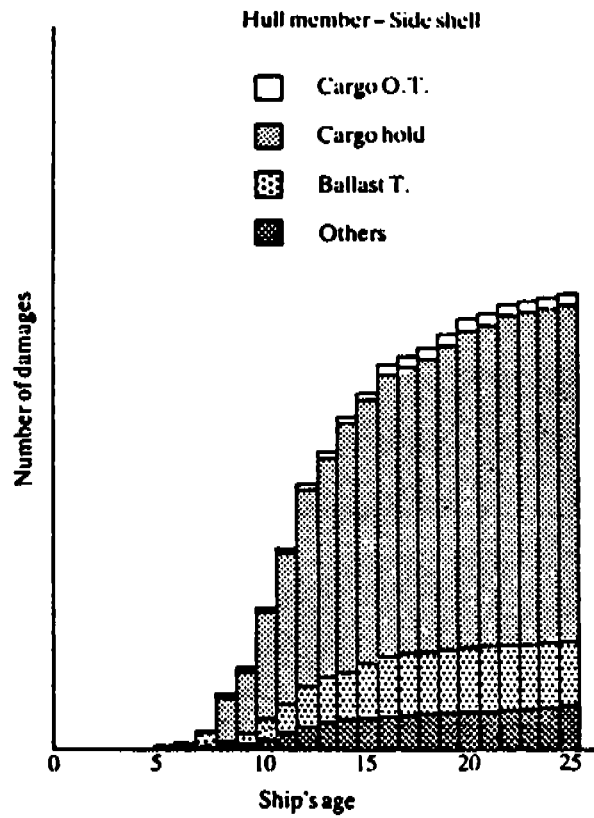


**Figure 3.1 - Relation Between Frequency of Damage to All Hull Structural Members, Different Causes of Damage, and Ship Age for All Ship Types**

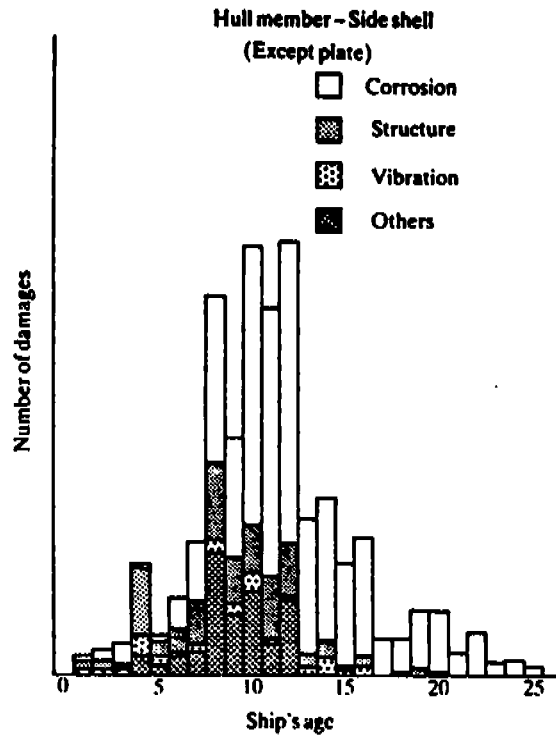


**Figure 3.2 - Relation Between Frequency of Damage Due to Corrosion and Fatigue for All Structural Members, Service Conditions, and Ship Age**

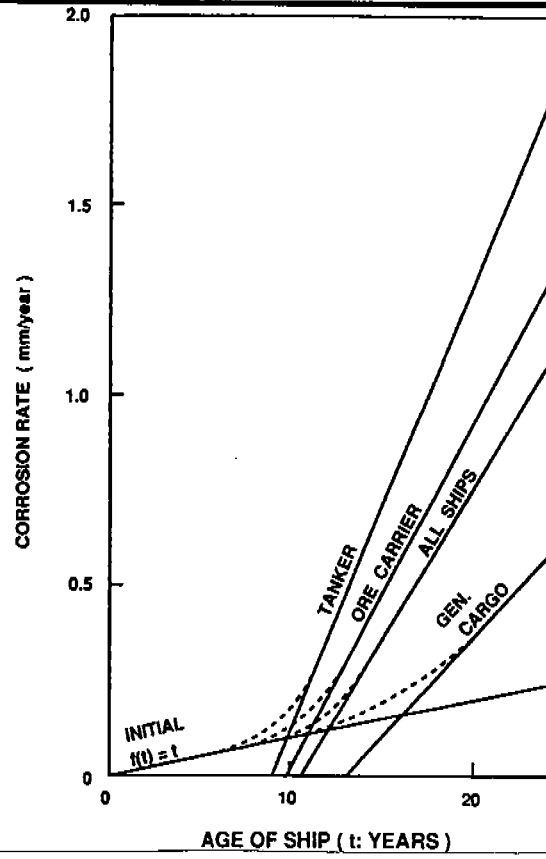




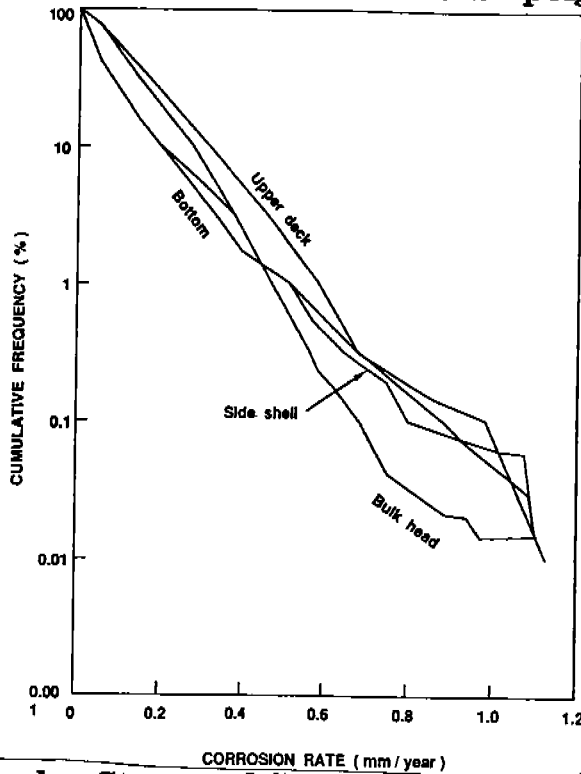
**Figure 3.3 - Relation Between Frequency of Damage Due to Corrosion and Fatigue in Side Shell Members, Service Conditions, and Ship Age**



**Figure 3.4 - Relation Between Frequency of Damage to Side Shell Members, Different Causes of Damage, and Ship Age**



**Figure 3.5 - Corrosion Rate as a Function of Ship Age and Type**



**Figure 3.6 - Tanker Structural Components Corrosion Rate Statistics**

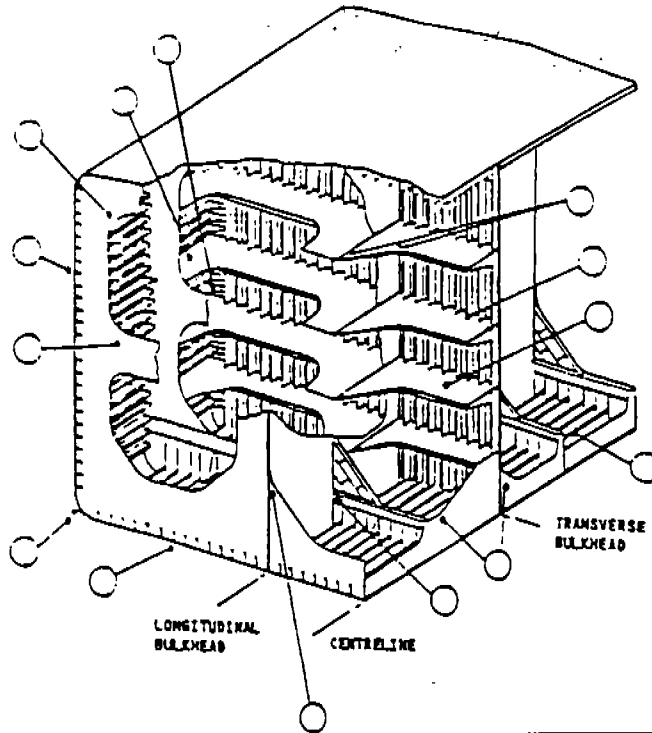
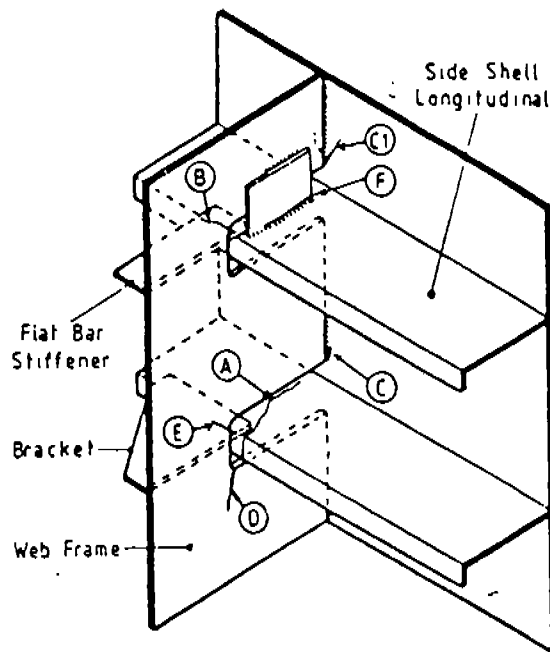
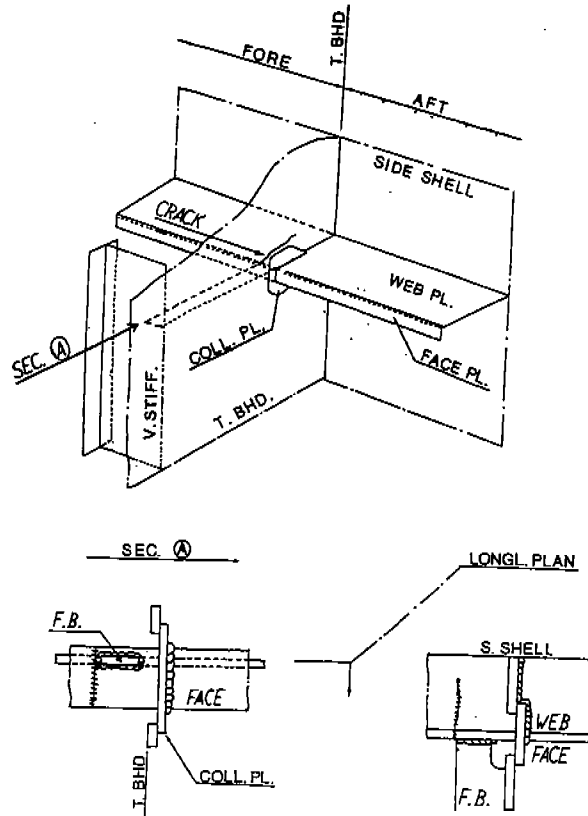


Figure 3.7 - Typical Fatigue Damage Locations in VLCCs

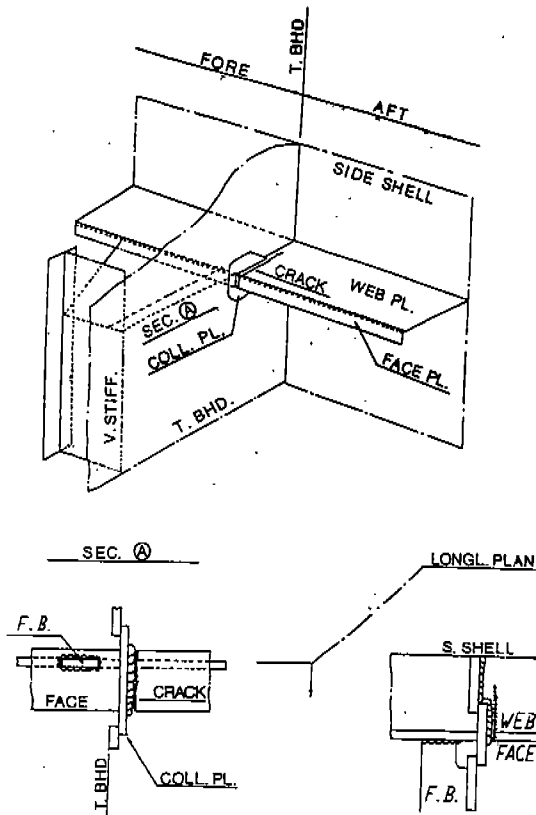


- A Longitudinal Stiffener Cracked.
- B Flat Bar Stiffener Cracked.
- C Shell Plate to Web Weld Cracked.
- C1 C Type Crack Extending into Shell Plate
- D Web Frame Cracked
- E Bracket Cracked
- F Lug Cracked. (Typical Detail)

Figure 3.8 - Typical Fatigue Damage to Side Shell Members and Connections



**Figure 3.9 - Side Shell Longitudinals Cracks at Transverse Bulkheads**



**Figure 3.10 - Side Shell Longitudinals Cracks at Transverse Bulkheads**

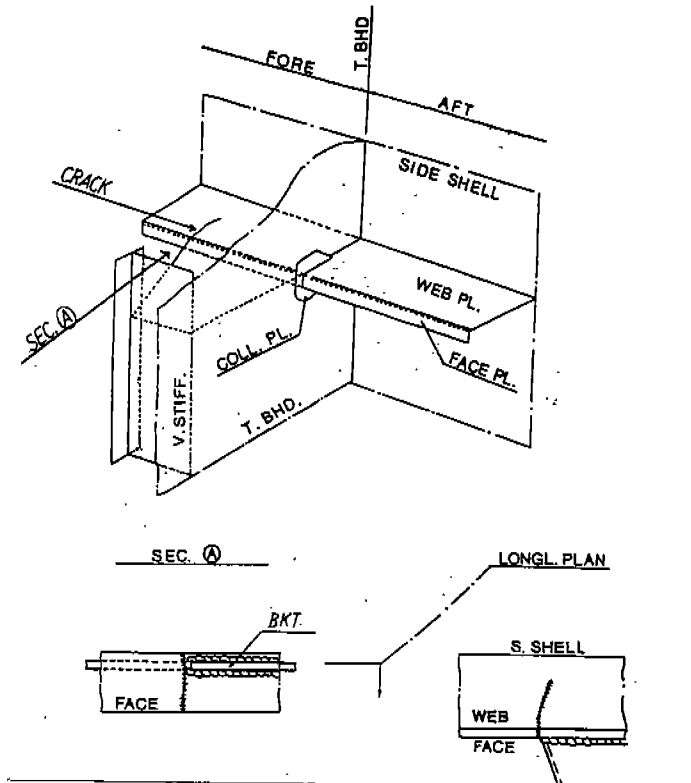


Figure 3.11 - Side Shell Longitudinals Cracks at Transverse Bulkheads

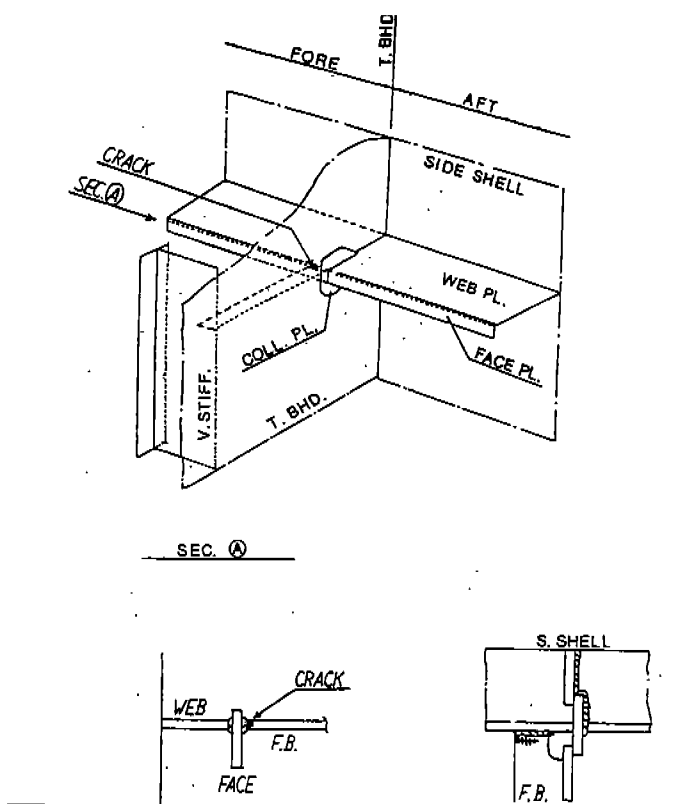
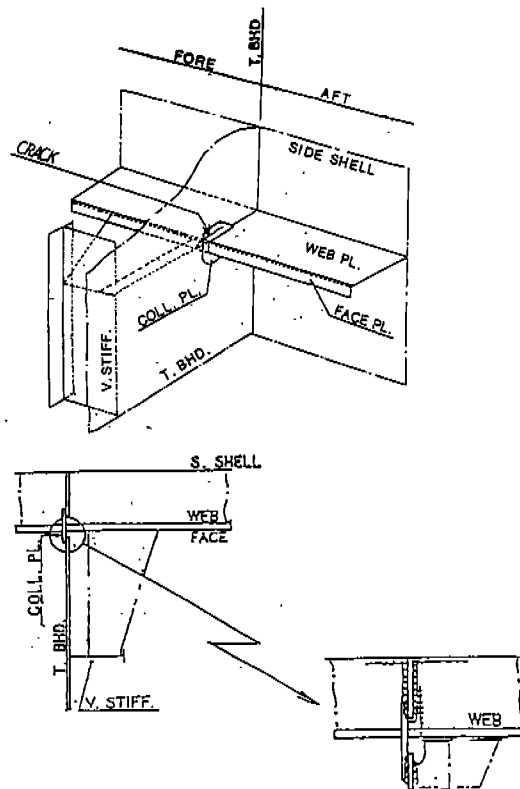
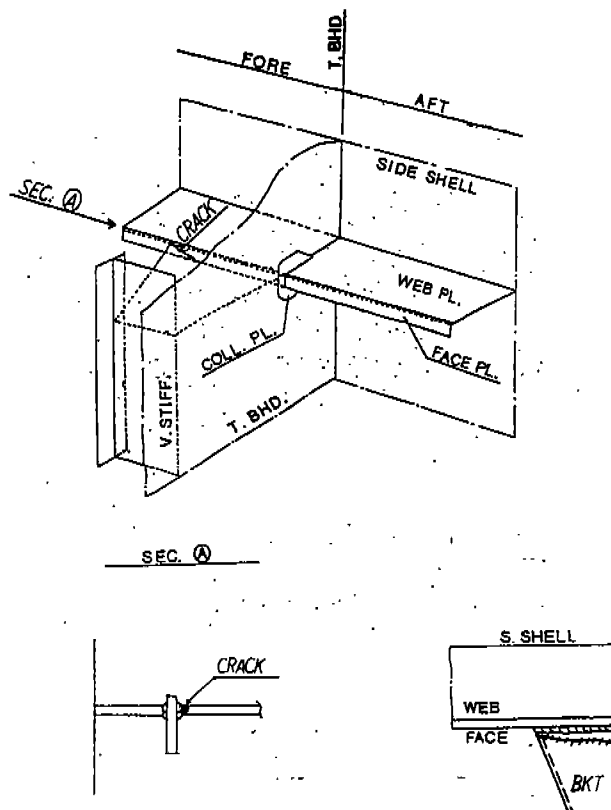


Figure 3.12 - Side Shell Longitudinals Cracks at Transverse Bulkheads



**Figure 3.13 - Side Shell Longitudinals Cracks at Transverse Bulkheads**



**Figure 3.14 - Side Shell Longitudinals Cracks at Transverse Bulkheads**

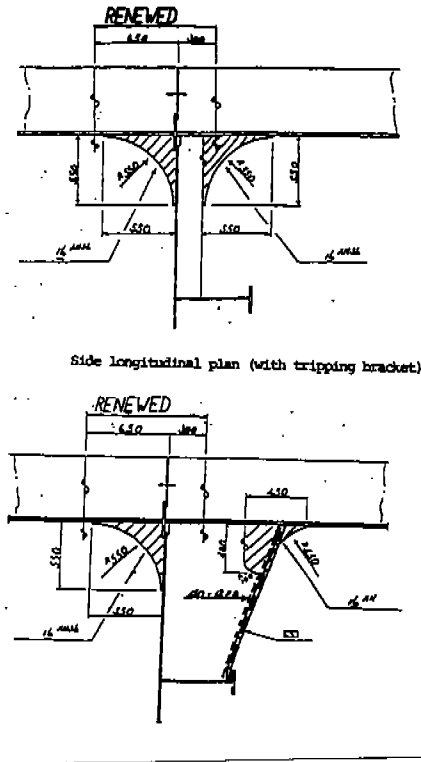


Figure 3.15 - Repairs to Side Shell Longitudinals (Reinforced with Soft Toe Brackets)

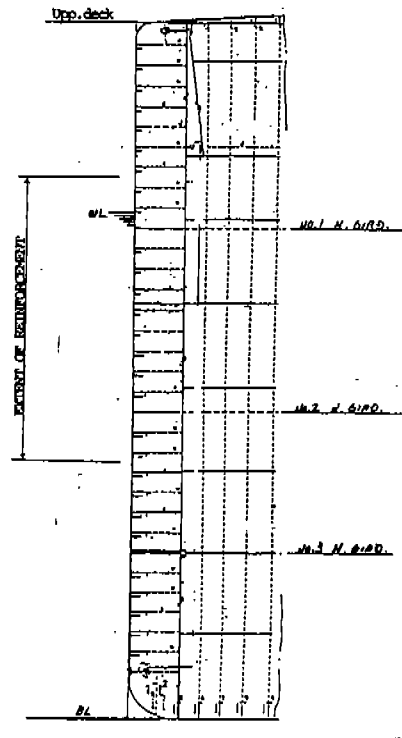


Figure 3.16 - Extent of Reinforcements to Side Shell Longitudinals

# Marine Structural Integrity Programs

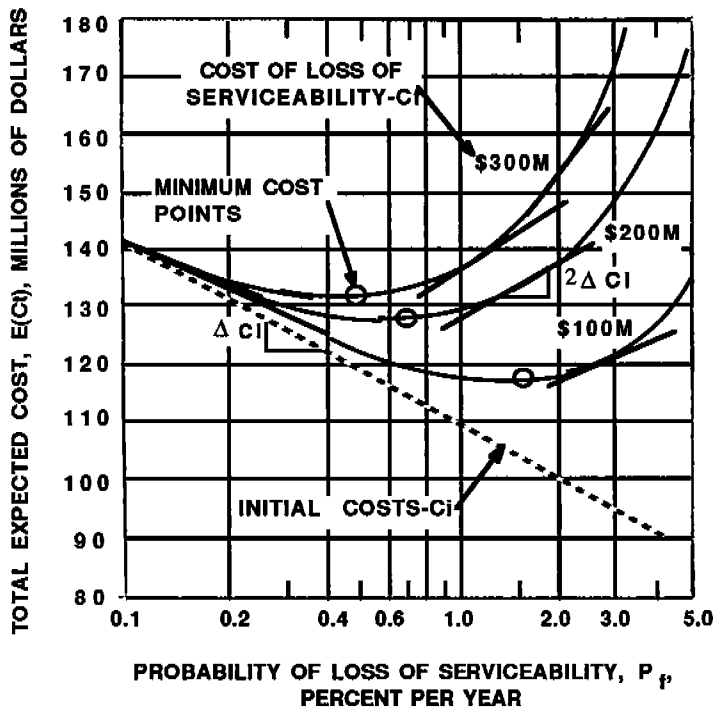


Figure 3.17 - Optimized Utility, Minimum Total Cost Evaluation

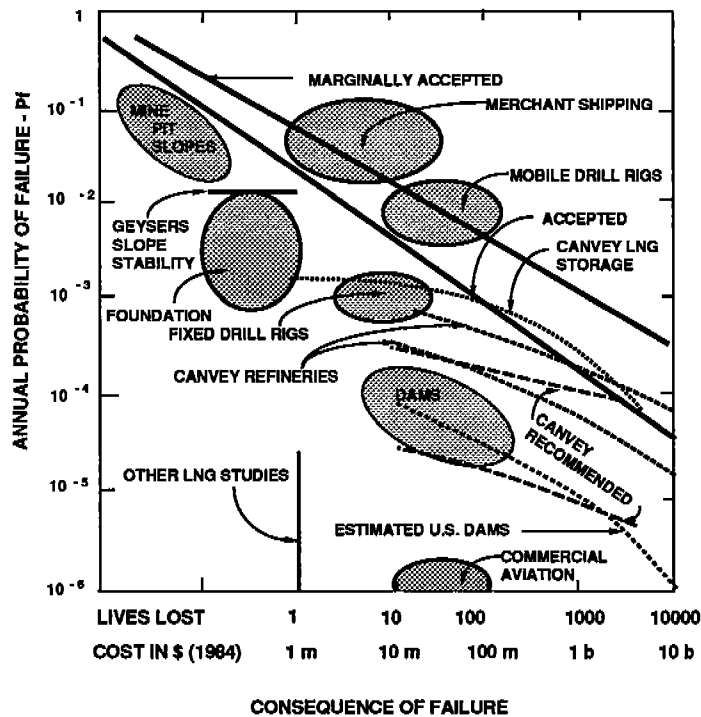


Figure 3.18 - Historic Relationships of Risks and Consequences for Engineered Structures



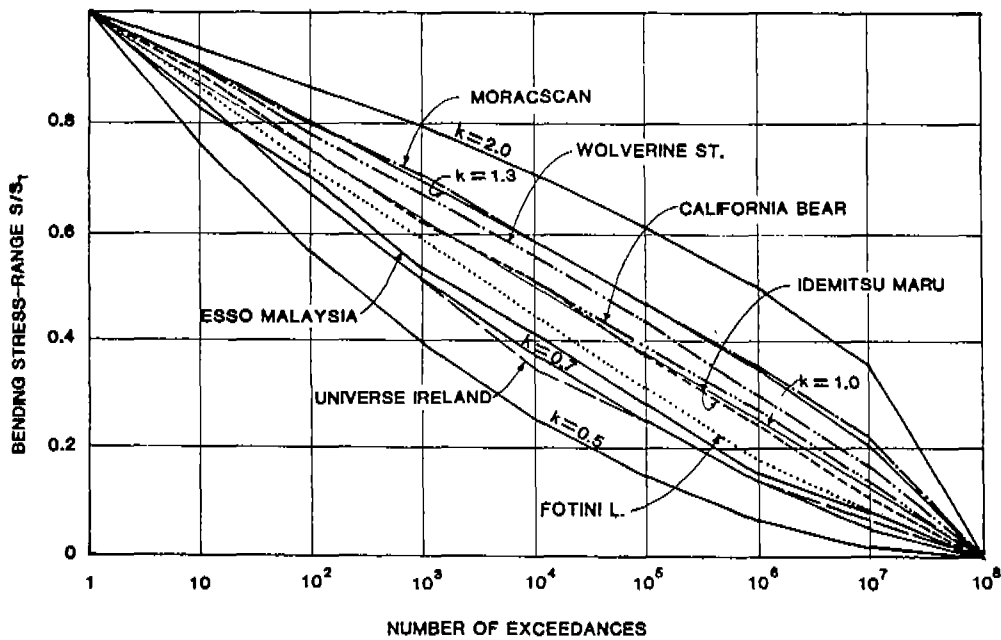


Figure 3.19 - Fatigue Loading Histories of VLCCs, Bulk Carriers, and Dry Cargo Vessels

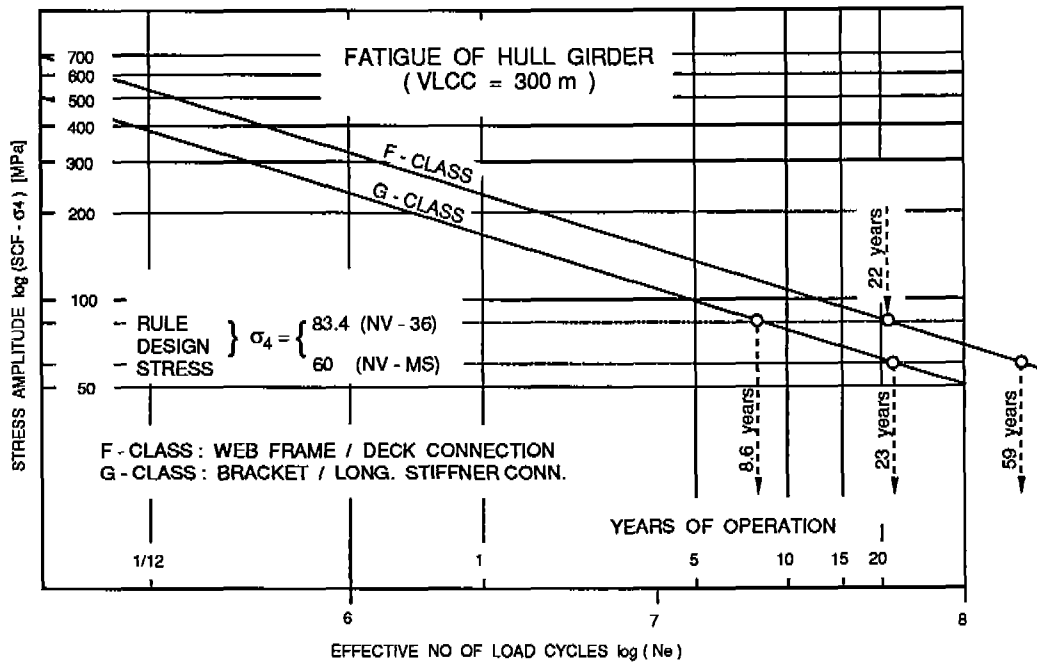
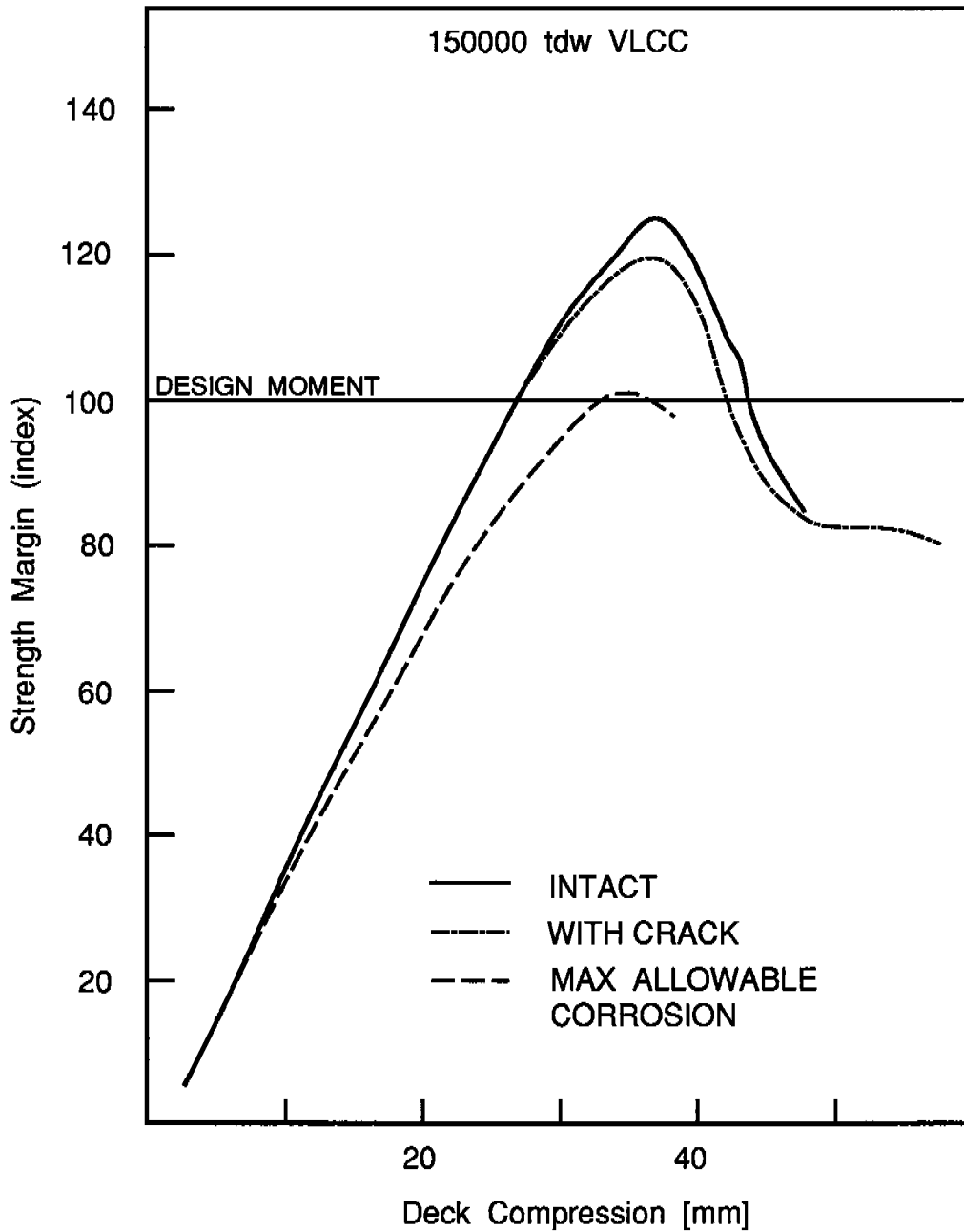
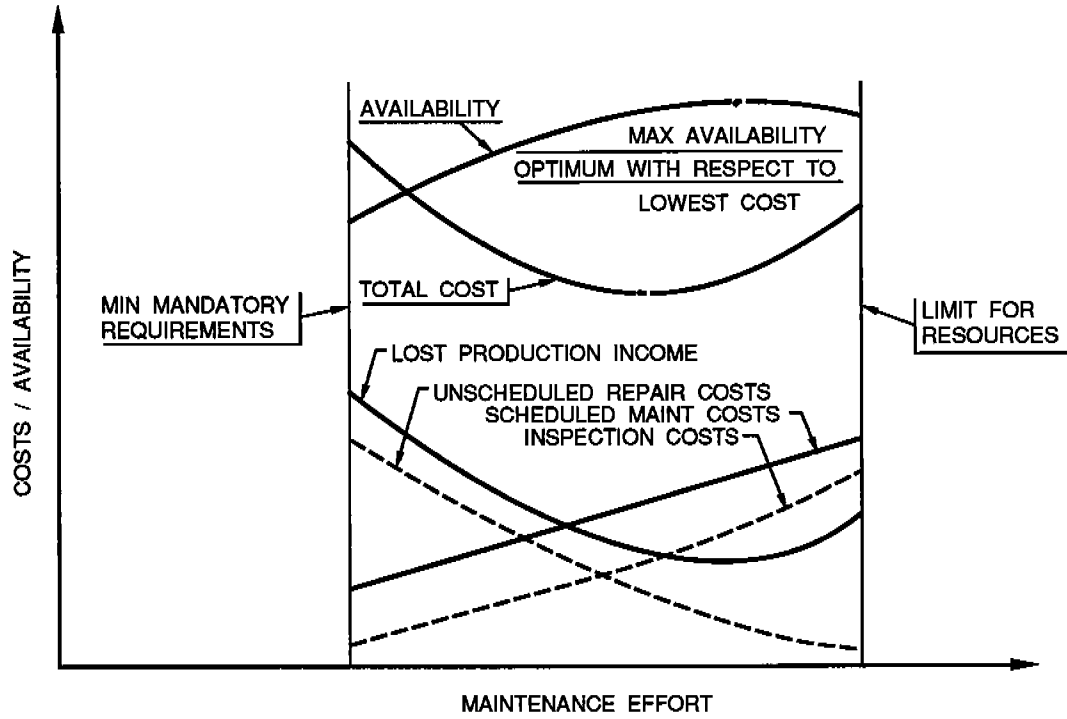


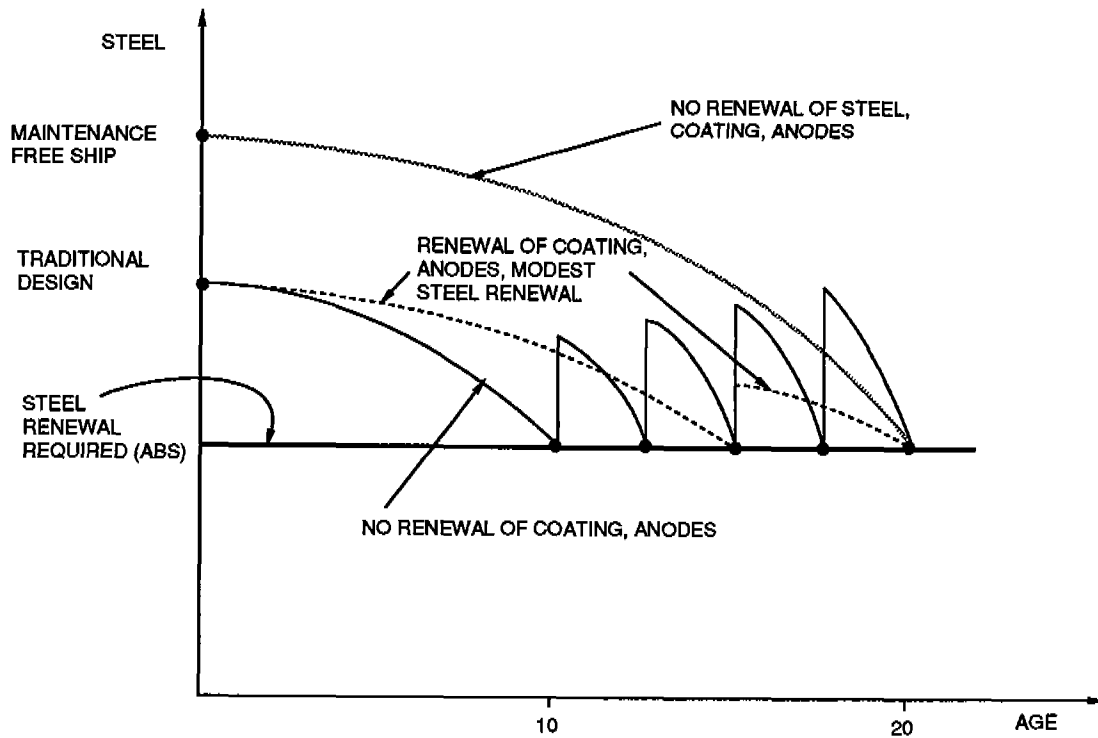
Figure 3.20 - Fatigue of 300 meter VLCC Hull Girder Deck - Bottom Structure Elements in World-Wide Operation



**Figure 3.21 - Effects of Fatigue Cracking and Corrosion on the Longitudinal Bending Capacity of a 150,000 DWT VLCC**



**Figure 3.22 - Cost - Benefit Evaluation as a Function of Ship Structure MSIP Effort**



**Figure 3.23 - Effective Ship Structure Steel Weight as Function of Design, MSIP Strategy, and Age**

## STRUCTURAL DESIGN

### Background

---

**The objective of this chapter is to define the principal improvements in structural design methods that can result from adoption of advanced MSIP. Of particular importance in this chapter are structural design methods and philosophies that can lead to improvements in the durability characteristics of tanker hull structure systems.**

As discussed in Chapter 3, design for durability is the primary issue for advanced MSIP for crude carriers. Closely related to design for durability is design for damage tolerance. Both of these design considerations are focused on **critical structural details or critical areas in the structural system that comprise the vessel hull.**

**Critical structural details or critical areas (CSD) are defined in this report as "those whose failure if remained undetected or unrepaired could lead to loss of the ship or a significant portion of its cargo."**

In terms of design for durability, experience with the present generation of tankers indicate that there are two primary issues regarding CSD:

- 1) **Design to prevent excessive corrosion, and**
- 2) **Design to prevent excessive cracking.**

The following sections will address these issues and the related issues of design for inspections, construction, and damage tolerance.

### Corrosion Durability Design

---

#### Factors

Several extensive studies of corrosion in crude carriers have been performed [4.1 - 4.8]. These studies indicate general and local (grooving,

pitting) corrosion are primary problems in both cargo and ballast tanks. Salt water, heating, and flexure of the structure can significantly accelerate corrosion rates. Corrosion can be severe on bulkheads separating ballast and cargo tanks which are heated. Average corrosion rates to some classes of CSD can exceed 1 mm per year [4.1-4.3]. The variabilities in corrosion rates throughout the ship are reflected in coefficients of variation (ratio of standard deviation to average) in the range of 40 to 140 percent [4.1,4.2].

Protection (coatings, cathodic), if maintained, can significantly inhibit corrosion or lower corrosion rates. There is a wide variability in the effectiveness of alternative types of coatings; effectiveness depends greatly on the chemical formulation of the coating system, its application, and its maintenance. High quality coatings, proper application, and proper maintenance are expensive and require a high degree of diligence to assure that the proper results are achieved. However, particularly in the case of salt water ballast tanks, high quality coatings appears to be the primary means of assuring long-term structural integrity. The use of white colored coatings can greatly facilitate inspections (rust streaks and areas of coating breakdown are highly visible).

Cathodic protection can act as a backup to coating systems, protecting areas that are no longer protected by the coatings (blistered, peeled, holiday areas). Cathodic protection measures can have limited effectiveness due to their inability to protect surfaces that are not submerged or not within the shadow zone of the anode, or to protect surfaces when the anodes are covered with debris and sediment. Proper placement and sizing of anodes to assure sufficient coverage, adequate life, and prevent coverage with debris and sediment are important considerations in design of cathodic protection systems. Cathodic protection, if well designed and maintained, can have an important effect in assuring adequate durability of CSD.

Corrosion can reduce metal thickness to the point where fatigue cracking develops [4.1, 4.3]. Grooving corrosion occurs at structural connections where there is adequate moisture, dissimilar metals (parent steel and welds), cyclic strains (cargo loading-unloading, seaway), and inadequate protection. Given sufficient numbers of high cyclic strains at such connections, fatigue cracks can develop prematurely [4.3, 4.9, 4.10]. Pitting corrosion has a small affect on fatigue strength [4.11, 4.12].

Classification Rules provide for increases in the initial thickness of CSD based on different corrosion and protection conditions. Similarly, there are provisions to define the corrosion limits of CSD. However, there is an extremely wide variability in these provisions [4.13-4.15]. There is little unanimity on how design allowances and limits should be developed, for both mild and higher strength steels. Correlated with the wide range in corrosion allowances and limits, there are wide variabilities in the performance of inspections and surveys to disclose excessive corrosion or breakdown in corrosion protection measures.

Development of an advanced MSIP must address the related issues of thickness measurements (patterns, techniques) design corrosion allowances for CSD, corrosion limits for CSD, and corrosion surveys and inspections. A procedure to define such limits will be outlined in Chapter 7 (Evaluation of Alternatives).

### **Corrosion Durability**

In terms of MSIP design for durability, two approaches to controlling and limiting corrosion should be implemented [4.1, 4.9]:

**1) Structural configuration, and**

**2) Structural protection.**

**Structural Configuration** - Structural configuration to minimize corrosion should include:

- Adequate corrosion allowances in metal thicknesses;
- Minimization of horizontal internals that can trap water;
- Minimization of high flexure structural components that can break down coatings and accelerate corrosion of unprotected surfaces;
- Provision of sufficient drain cutouts and sloping tank bottoms that can be flushed to remove water, corrosion, debris, and sediment accumulations; and
- Provision of contoured metal surfaces (e.g. plate edges) and intersections that will facilitate applications of sufficient thicknesses of protective coatings.

**Structural Protection** - Structural protection of CSD in highly corrosive environments (e.g. salt water ballast tanks, cargo tank bottoms) should include properly designed and maintained, high quality:

- **Impervious and inhibitive coatings, and**
- **Passive cathodic protection systems.**

**The fundamental objective is to minimize corrosion to the maximum extent that is practical.**

**Coatings** - Impervious coatings are those such as coal tar epoxy. These coatings protect the base metal by excluding the corrosive elements

from the base metal. Coatings can be either hard or soft. Hard coatings are the most popular.

Inhibitive coatings incorporate pigments such as zinc that form a passivating film on the surface, resulting in corrosion of the pigment rather than the base metal. The coatings have low permeability; thus, they can provide two mechanisms to protect the underlying metal.

Table 4.1 summarizes the protective mechanisms and types of coatings that can be used to provide various degrees of protection to metal surfaces [4.16]. Coating systems based on these types of coatings can have average lives that range from 2 to 3 years (12 mil, 3-coat, chloride coating) to 6 to 8 years (25 mil 2-coat, epoxy), to 12 to 14 years (45 mil 3-coat epoxy)

All of the coatings suffer from aging effects, becoming more brittle and losing adhesion; thus, they become more influenced by tertiary flexure of the structure elements and abrasion.

Given the selection of a high quality coating, experience indicates that the biggest problems are with proper application of the coatings (surface preparation, applying to the surface, curing, achieving proper thicknesses). Surface preparation and application standards have been developed [4.17-4.20]. Development work is being conducted by coating manufacturers to improve the flexibility of the coatings and their abilities to maintain flexibility and adhesion. Very high viscosity coatings have been developed to allow coating thickness to be maintained on sharp edges of structural elements.

Vigilant maintenance and repairs of corrosion protection is a necessity for advanced MSIP for VLCCs and ULCCs. Given good initial application, time to repairs of coatings may range from 6 to 8 years (or more) for two coat epoxy coating systems to 2 to 3 years for chloride coatings [4.21]. With present-day high quality coating systems, even if maintenance and repairs are carried out, total recoating may be expected in ballast tanks within a 10 to 12 year period [4.21].

Different paint maintenance methods include [4.17, 4.20]:

- Spot blasting areas of severe coating degradation and repainting only the blasted areas.
- Spot blasting areas of severe coating degradation and detergent washing intact (non-blasted) coating; the blasted areas receive multiple coats of paint and the washed areas one topcoat.
- Spot blasting areas of severe coating degradation and sweep blasting areas of intact coating; blasted areas receive multiple coats of paint and the sweep blasted areas receive multiple coats.



- Blast and repaint all of the structure.

To make determination of the condition of existing coatings, standards have been developed to develop more objective and consistent maintenance [4.19,4.20]. In many cases, inspections to determine coating integrity are conducted on an annual basis. The scope of maintenance can be determined as follows [4.17]:

- Areas exhibiting coating deterioration of 3 % or more of a given surface will be repaired (blasted and recoated) if the areas comprise 10 % or more of the total surface area in the tank.
- If areas exhibiting coating deterioration of 3 % or more comprise 50 % or more of the total tank area, then 100 % of the tank will be repaired.
- Isolated areas exhibiting coating deterioration of 33 % or more over a 10 ft<sup>2</sup> or greater area will be repaired regardless of the percent of total surface area they comprise in a particular tank.

**Cathodic Protection** - There are two types of cathodic protection systems; active and passive [4.1]. Active systems are called impressed current systems and consist of a current source and an anode to deliver the current to the fluid. Their biggest problems are associated with noxious gas production (Hydrogen and Chlorine) and with interruption of the DC current source. If the source is interrupted, the structure becomes the anode and greatly accelerated corrosion results.

Passive cathodic protection systems employ sacrificial anodes that are typically zinc (in cargo tanks), and aluminum (in ballast tanks). When in contact with the structure and the fluid, the anode corrodes and the steel structure is protected. The anodes must be of the proper chemical composition and be properly sized and placed to provide protection. The surfaces to be protected must be submerged. Submersion of the anode under sediment in tank bottoms or shorting of the anode with debris can destroy their effectiveness. When the sacrificial anodes are consumed, they must be replaced to continue the protection.

Both coatings and passive cathodic protection systems have been used in tankers. The passive cathodic protection system is intended primarily to provide backup to the coating system in case of defects or breakdowns in the coatings. Protection of saltwater ballast tank steel should involve complete and high quality coatings backed up by well designed cathodic protection systems [4.22].

## **Fatigue Durability Design**

---

The Tanker Structure Co-operative Forum (TSCF) has developed a catalog of structural details failures which have occurred on VLCCs and ULCCs [4.23]. An extension of this data base has been developed in references [4.24-4.26]. The analyses of the failures in these data bases indicates a major part of durability problems are associated with premature cracking of CSD. The majority of cracks are fatigue type failures and concern the following types of details:

- **Intersections of longitudinals and stiffeners (particularly side shell longitudinals) with primary supporting structure (e.g. transverse bulkheads),**
- **Bracketed end connections of primary and secondary supporting elements,**
- **Discontinuities in high stressed face plates, stiffeners, and longitudinal members,**
- **Openings and cut-outs in primary structures, and**
- **Bad weld profiles and poorly cut plates.**

Analyses of recently compiled CSD cracking data from VLCCs indicates cracks in the side shell longitudinals account for about half of all cracks; most of these cracks occur midships and within the middle third of the hull height [4.24-4.26].

### **Causative Factors**

Inspections of these types of failures [4.10,4.25-28] indicates that they are generally due to:

- **Inappropriate design,**
- **Low quality construction,**
- **Poor maintenance, or**
- **A combination of the foregoing.**

Inappropriate design is fundamentally due to a lack of explicit consideration of cyclic loading effects in CSD. Classification Rules for primary hull structure and scantlings designs have been applied to situations in which they are not resulting in sufficiently durable CSD. Reductions in

strength margins contained in Classification Rules, the use of higher strength steels, and the use of greater depth to breadth hull cross sections have tended to exacerbate the problems of fatigue cracking in CSD.

Figures 4.1 and 4.2 show original and revised CSD from a VLCC that is currently (1991) being constructed. Fatigue analyses were performed on the proposed designs. The originally designed CSD had expected lives that ranged from 6 to 19 years. The revised designs had expected lives that ranged from 44 to 85 years. This experience is consistent with the analyses of tankers reported in references [4.44,4.45] where many CSD expected lives ranged from 2 to less than 10 years.

Most Classification Rules for the determination of crude carrier hull girder strength or structural detail strength do not contain any explicit requirements or criteria related to fatigue or durability design. The majority of these Rules have been based on extensive service experience rather than on detailed fatigue analyses [4.21].

As discussed in Chapters 1 and 3, durability problems have apparently developed because of a rapid change in the configuration and size of tankers and in the materials and fabrication procedures used in construction of these vessels [4.29-4.31]. Coupled with pressures to reduce initial costs of these vessels, and operations in severe weather trade routes, structural strength margins have been reduced to the point where stress/strain levels in CSD have been raised to the point where fatigue and durability problems are evident [4.31,4.32].

In the few cases where explicit fatigue design has been employed for some CSD, premature fatigue failures have been attributed to ignored or poorly understood sources and locations of cyclic stressing and poor configuration of details (not minimizing stress concentrations). Studies of these cases [4.21, 4.45] indicate lowering stresses in the CSD (through increasing material thicknesses and re-configuration of the details to minimize stress concentrations) can result in acceptable fatigue lives.

Table 4.2 summarizes the elements of three goals to enhance fracture control [4.10]. The goals address:

- **Design - specification of strength and fracture resistance properties;**
- **Fabrication - protection of specified strength and fracture properties, and**
- **Operations - maintenance of strength parameters**

Inappropriate design frequently leads to low quality construction because the details are not configured to recognize construction methods and realistic fit-up tolerances. Inappropriate design also can lead to neglected

---

## **Marine Structural Integrity Programs**

---

maintenance thorough the inadvertent formation of corrosion traps, through neglect of design of adequate corrosion protection, and through lack of consideration of inspectability (during construction and operation).

Low quality construction and neglected maintenance generally arise because of lack of adequate quality assurance and control procedures and measures. Hand flame cut, unfinished plating in CSD; substituted grades of steel; accepted large misalignments of CSD, and incompletely welded and poorly welded CSD are symptoms of poor construction quality control.

Similar symptoms are apparent regarding neglected or poorly conducted operations and maintenance. Tanks and CSD that are not inspected at all, coatings and cathodic protection that have disappeared (or were never there in the first place), and poorly designed and executed corrosion and cracking repairs are symptoms of poor maintenance quality control. Significant sections of tanker side shell have been lost, or tanks flooded immediately after leaving the drydock in which maintenance surveys and inspections were performed.

Although difficult to document, ship operations during loading and unloading and while underway also apparently can have significant effects on durability. Driving loaded ships at full speed into severe head seas for long periods of time and failing to follow loading and unloading procedures have reportedly resulted in significant damage to and cracking in the ship structure. In commercial ASIP, operating envelopes for the aircraft are carefully monitored and maintained to avoid durability problems. It is precisely for this reason that military aircraft in which operating envelopes often can not be carefully monitored and maintained experience significant durability problems.

**In the vast majority of the cases studied during this project in which excessive fatigue cracking problems have been experienced in tankers, there is existing and proven marine MSIP technology that can be used to minimize the durability problems. The basic problem is not technology; it is its proper and effective application and the expenditure of sufficient resources to assure that desirable levels of durability in the ship are developed.**

### **Fatigue Design Procedures**

Fatigue design procedures can be organized into three basic procedures:

- 1) Conventional design (scantling proportioning rules),
- 2) Semi-direct design (prescribed scantling allowable stresses), and
- 3) Direct design (detailed fatigue analyses).

The procedure advocated in this study for a next generation MSIP for design of CSD is a semi-direct design procedure based on a "Safe Life" approach. In this procedure, CSD cyclic stress characteristics are determined using "first principle" structural and loading analysis techniques. This procedure involves five basic engineering evaluations:

- 1) Characterization of the life-cycle (short and long term) conditions that lead to cyclic loadings;
- 2) Determination of the cyclic forces imposed on and induced in the structure system;
- 3) Evaluation of the cyclic stresses (strains) developed in the element of concern;
- 4) Determination of the degradation (reduction in strength and stiffness) of the element caused by the cyclic stresses; and
- 5) Determination of the acceptability of the anticipated fatigue damage or degradation.

**Design for durability or fatigue reliability is one of three primary inter-related structural design considerations:**

- 1) **Design for strength (hull capacity),**
- 2) **Design for buckling (retention of hull residual strength), and**
- 3) **Design for fracture (retention of hull durability and ductility).**

Each of these considerations influences design for durability. If design for strength and buckling lowers cyclic stress levels to sufficiently low levels and design for fracture assures adequate material and weldment toughness, then design for durability can be a secondary issue or consideration. It is in the attempt to achieve balance (reliability and economy) between the four design issues that design for durability becomes a primary issue.

**Safe Life** - Practical methods have been developed to perform fatigue analyses of CSD including determination of the long-term distribution of stresses, accumulation of fatigue damage, and determination of fatigue design criteria. These methods have been used in design of a wide variety of marine structures, and in some cases, ships. In most cases, for design of marine structures, the "safe life" approach has been employed in which the critical stress levels in the CSD are determined so that the CSD will have an expected life that is several multiples of the anticipated service life of the CSD. Generally, this approach has been referred to as the S-N or Stress - Number of cycles to failure approach [4.33-4.36].

**Allowable Stress and Stress Range** - In one of its simplest forms, the S-N approach can be expressed as an allowable stress range,  $S_{rf}$ , for a CSD:

$$S_{rf} = \left[ \frac{K}{N_c Y} \right]^{1/m} (\ln N_c)^{1/\epsilon}$$

where:

K - life intercept of design S-N curve,

m - slope of design S-N curve,

$\epsilon$  - Weibull shape parameter for long-term stress distribution,

$N_c$  - total number of stress cycles during the design service life,

$Y = \Gamma \left( 1 + \frac{m}{\epsilon} \right)$ , and

$\Gamma$  - Gamma function.

The S-N curve parameters, K and m, are based on the results from fatigue tests performed on given types of CSD [4.37-4.40]. These parameters should reflect the following:

- a) General quality of a given type of CSD (its ability to minimize stress concentrations),
- b) The expected construction quality (reflected in the materials and welding used to fabricate the CSD),
- c) The expected maintenance quality (reflected in corrosion prevention), and
- d) The expected inspection quality (assuring construction and maintenance requirements are met).

Adjustments to the S-N curve parameters may be necessary to recognize unusual stress conditions not incorporated in to the fatigue test based S-N curves.

The Weibull shape parameter,  $\epsilon$ , is based on results from stress analyses of typical hull structures (given trade routes, cargo and operating conditions, locations within those structures, and CSD within those locations). General "mapping" of  $\epsilon$  can be developed for typical types of crude carriers trading on given routes [4.41-4.44].

$N_c$  is based on the design life of the CSD and the average frequency of cyclic loadings during that design life. The design life may incorporate a factor of safety (design life = factor of safety x service life) that depends on:

- a) The criticality of the detail (how important it might be to the strength and integrity of the structure),
- b) The inspectability of the detail (how easily unexpected flaws and cracks might be detected), and
- c) The reparability (ease and rapidity of being able to make repairs.)

Given definition of these parameters, design stress range curves that can be used to facilitate design of CSD can be defined [4.38-4.40].

Given a defined relationship between the maximum internal and external loading components, the allowable stress range ( $S_{rf}$ ) can be expressed in terms of a maximum allowable stress ( $S_{fm}$ ):

$$S_{fm} = (R) S_{rf}$$

thus,

$$S_{fm} = (R) \left[ \frac{K}{N_c Y} \right]^{1/m} (\ln N_c)^{1/\epsilon}$$

**Allowable Damage** - An alternative simplified S-N design formulation has been proposed [4.33, 4.34]. This formulation is based on the determination of an allowable cyclic stressing damage to a CSD:

$$\Delta_0 = \frac{\lambda \Delta_{50}}{(B_{50})^m \exp(\beta \sigma)}$$

where:

$\Delta_0$  - allowable damage,

$\lambda$  - ratio of median to design S-N intercept ( $\lambda = K_{50} / K_0$ ),

$\Delta_{50}$  - median damage at "failure",

$B_{50}$  - median bias in fatigue analysis,

$m$  - slope of design S-N curve,

$\beta$  - desired Safety Index (probability of survival)  
for CSD durability, and

$\sigma$  - uncertainties in fatigue analysis.

The nominal design damage to a particular CSD is calculated from:

$$D_0 = \frac{T_s \Omega}{K_0}$$

where:

$D_0$  - computed damage,

$T_s$  - service life (years),

$\Omega$  - long-term stress parameter, and

$K_0$  - design S-N life intercept.

The long-term stress parameter based on a distribution is:

$$\Omega = f_0 S_m^m Y [ \ln N_c ]^{-m/\epsilon}$$

where (other terms previously defined):

$f_0$  - average frequency of cyclic stresses, and

$S_m$  - expected largest lifetime stress range.

Comparisons of this and similar simplified approaches with the results of detailed fatigue analyses and with service experience indicates that with proper definition of the S-N curve parameters (e.g. use of -2 Standard Deviation S-N curve), the Weibull shape parameter ( $\epsilon$ ), the design life (service life x factor-of-safety), and the expected number of stress cycles ( $N_c$ ), a simplified approach can develop results that are in close agreement with results from detailed analyses and service experience [4.42-4.45].

**It is a high priority that future developments of the MSIP durability design improvements should be focused on development and implementation of explicit Safe Life S-N based approaches for CSD within tanker hull structures.**

**Repairs** - The S-N approach also should be used to engineer repairs to existing and new hull structure defects and cracks. Design of adequate repairs to fatigue associated damage should become an integral part of MSIP.



An important part of future MSIP fatigue durability developments concerns determination of fitness for purpose of cracked structural details [4.25, 4.36]. This development is needed because it is practically impossible to construct and operate a welded steel hull structure without the presence of cracks in the structural elements. Many of these cracks develop as a result of corrosion (e.g. attack of the weld heat affected zone at the toe of the weld) and because of improper fit-up of elements during construction. In many cases, these cracks can not be immediately repaired; temporary repairs may be ineffective and even exacerbate the cracking.

If CSD are cracked to a significant extent (approaching critical crack lengths where the cracks propagate rapidly) and the progressing cracks threaten the strength and leak integrity of the hull structure, then these cracks must be repaired as soon as possible. However, there are many CSD and Secondary Structural Details (SSD) where cracks have not reached critical lengths or they do not threaten the strength and leak integrity of the hull structure. In these cases, a procedure is needed to assess whether or not the cracks can be accepted for various periods of time.

Development work has been initiated on an S-N based procedure to assess the suitability for proposed service of cracked structural details [4.25, 4.36, 4.48]. The work has addressed development of a hybrid S-N / Fracture Mechanics (F-M) analysis that would permit practical analyses of defective or damaged welded details. For the calculation of the residual life of cracked details a fracture mechanics approach is used to establish a set of S-N curves for different crack lengths. This set of curves is compatible with the design S-N curves for uncracked details.

The use of predicted fatigue crack growth behavior in the updating of fatigue design life has been investigated [4.46-4.48]. Based on experience and experimental fatigue crack growth tests, the relationships between developed crack size and remaining fatigue life has been characterized. These analyses have established a definitive link between a conventional S-N fatigue analysis model and a fracture mechanics analysis model. This has particularly important ramifications in development of acceptability criteria for cracked internal structural details, avoiding the zero crack tolerance syndrome.

These and other similar analyses have demonstrated the critical importance of defining realistic probability of detection (POD) curves based on practical ship inspection methods. The work has been extended to include a cost - benefit model to evaluate alternative strategies for inspections, maintenance, and repair (IMR) [4.46, 4.47, 4.49].

**The studies described in reference [4.25] indicate that it is impossible to perform inspections that will reliably disclose the presence of all significant cracks in the CSD of tankers. The POD curves used in some recent fatigue analyses developments [e.g. 4.46, 4.47] indicate an 85 to 90 % probability of detecting cracks 1-inch in length in all CSD that comprise a VLCC or**

**ULCC. Due to the difficulties of access, lighting, coatings and other visual impediments (wax, rust, sediment), the difficulties of using NDT methods, and the sheer number of CSD that are in the hull structure such POD characterizations are not realistic. Additional work is needed to define realistic POD characterizations.**

**Fatigue Design Reliability** - As for definition of corrosion allowances and limits, the definition of the allowable cyclic stress ranges for CSD will implicitly involve definition of the level of reliability that is desired for the particular CSD. This consideration introduces recognition of the uncertainties in the various parts of the design, construction (materials, fabrication, inspection qualities), and operations (inspection, repair qualities) processes and the degree of safety that is deemed necessary or acceptable for the CSD [4.46-4.49]. In the definition of the allowable stress range, these considerations can be reflected in the selection of S-N curves (probability levels selected for definition of K and m) and the definition of the design service life (factor of safety applied to the actual service life). These considerations will be addressed in further detail in Chapter 6.

**Fatigue Design Testing** - Laboratory testing of elements and components (assemblies of elements) and field monitoring (gathering high quality data on loadings and performance of elements and components) are of critical importance. Laboratory testing is also needed on repaired elements. The fatigue analysis process is fundamentally empirical. Empirical factors must be used to characterize life cycle cyclic stress conditions, cyclic stress degradations, and stress concentrations. Adequate laboratory testing and field monitoring should be developed to provide the necessary data to perform the analyses.

In ASIP, testing and monitoring are the bulwarks of the durability design process. In MSIP, testing and monitoring are not highly developed. Even though a large body of very useful data has been generated on the fatigue characteristics of elements, the information is deficient in its ability to properly guide the engineer in selection of the empirical parameters involved in the fatigue analysis. There are very large uncertainties that must be accommodated with factors of safety and inspections to catch early indications of latent problems.

**A critical issue in developing the next generation MSIP will be advancing testing and monitoring to develop the necessary information to assure adequate and affordable durability in CSD of tankers.**

**Fail Safe** - An alternative approach that has been used in some cases of marine structures, and in most cases of ASIP is the "fail safe" approach. In this approach, fracture mechanics (F-M) is the primary foundation upon which initial flaw size distributions are analyzed to determine the rate at which they can grow to a critical size. Inspections and inspectability determine the initial flaw sizes and determine the factors of safety (inspection periods and methods) that must be employed to avoid crack

growth to critical sizes [4.35, 4.46, 4.47]. As for the safe life approach, quality of construction, inspection, maintenance, and repairs are primary considerations in this approach.

In addition, the fail safe approach employs design procedures to assure a degree of damage tolerance. The degree of damage tolerance depends on the multiplicity of alternative load paths (excess capacity combined with redundancy and ductility) and the degree of inspectability.

As noted in Chapter 3, it is here that there are major differences between ASIP and MSIP. These differences are founded primarily in the degree of inspectability of the two types of structures. The probability of detecting a 1 mm long crack in CSDs with 90 percent reliability and 85 percent confidence is realistic for an airframe that is brought into a well lighted and dry hangar, stripped, thoroughly cleaned, and subjected to extensive non-destructive testing. Under the best of conditions, the comparable figure for the CSDs of a modern crude carrier might be of the order of detecting a 100 mm long crack with 90 percent reliability and 85 percent confidence during the first and second special surveys. By the time cracks have approached the upper part of this range, they have essentially reached a critical length and are propagating so rapidly that they must be stopped (e.g. end drilling) and either permanent or temporary repairs made.

The extreme difficulties associated with present inspections of tankers make fracture mechanics based fail safe approaches of questionable applicability to these structures for purposes of design of CSD. **For this reason, it has been recommended that a practical, advanced MSIP for design of CSD in crude carriers should be based on the safe life approach.**

This is not to say that the F-M approach should not play a role in an advanced MSIP. As discussed earlier, the F-M approach can be used in assisting repair decisions regarding cracking in elements other than CSD, for example in secondary structural details (SSD) that are not critical to hull strength, stability, or external cargo losses [4.21, 4.25]. Given an inspection that discloses cracking in some SSD (e.g. hydrostatic stiffeners - tank bottom intersections in a double hull ship), the question is how rapidly the cracking must be permanently repaired. Temporary repairs (e.g. end drilling cracks, cold patching cargo bulkhead cracks) and operating procedures (ballasting, cargo loading) can be employed until the facilities can be mobilized to affect permanent repairs.

If future development of tanker inspections and monitoring will allow sufficiently reliable and consistent detection of cracks in CSD, then F-M based Fail Safe design approaches could be utilized to a greater extent, reducing the conservatism introduced through the use of the safe life approach.

Another part of this approach that should be applied to CSD in tankers regards the fail safe design of individual CSD. In ASIP, CSD are

configured specifically to arrest the propagation of cracks, and to facilitate high quality and efficient construction, inspection, and maintenance. Advanced MSIP for CSD should address the potential reconfiguration of individual CSD in tankers, with particular emphasis given to elements such as side shell longitudinal - transverse bulkhead and web frame intersections. There are many such intersections in airframes. These intersections are subjected to forces very similar to those of a tanker (global longitudinal and transverse flexure, local external and internal pressures). Much thought and testing has been devoted toward configuration of these critical details in airframes; a similar effort and focus is suggested for CSD in tankers.

### **Fatigue Design Philosophy**

**The fundamental objective of a fatigue analysis should be to eliminate anticipated durability problems with CSD.** Fatigue analysis is intended to provide engineering insights into how cyclic stresses can be lowered to the point where adequate durability is achieved. Design for fatigue durability has four principal lines of defense:

- **Minimize stress concentrations;**
- **Minimize flaws (misalignments, poor materials, weld defects);**
- **Minimize element degradation (materials, welding, corrosion protection, employing crack stopper designs);**
- **Minimize system degradation (damage tolerant assembly of elements and components).**

### **Design for Inspections, Construction, and Damage Tolerance**

---

As discussed earlier in this Chapter, inspections, construction, and damage tolerance all influence structural design for durability. The quality of construction is a strong determinant in the degree of durability. The quality of construction influences the selection of several of the key fatigue design parameters.

#### **Design for Inspectability**

Inspections influence structural design for durability in several ways. The quality of inspections influence the quality of design (catch errors), quality of construction (catch materials and fabrication problems and defects), and quality of maintenance (catch unanticipated cracking and

corrosion in CSD). All of these influences affect in a major way the uncertainties that pervade the fatigue design process; high quality inspections through the life cycle reduce uncertainties, leading to more efficient (less costly) and effective (less unpleasant surprises) durability characteristics.

At this stage of development of inspections of crude carriers, design to facilitate inspectability is focused on what can be done to the configuration of the hull structure to facilitate personnel access and inspections, and safety (refer to next Chapter).

To minimize gas hazards, ventilation is critical in both cargo and ballast tanks. Effective and efficient degassing of these spaces can be facilitated by the following design measures:

- Large drain and vent holes in structural elements where gas accumulations are likely;
- Proper sizing, number, and location of auxiliary cleaning equipment;
- Large external openings permitting air and personnel access to the tanks; and
- Design of flow paths for ventilators to reach all corners of tanks.

Minimization of climbing hazards through provision of longitudinal and transverse horizontal stiffeners of sufficient width to provide walkways, interconnected with access stairs, and protected with railings is an excellent example [4.50]. As noted in Chapter 3, this and other considerations can lead to fewer CSD, wider spaced stiffening elements, and thicker shell plates.

The height and flange width of bottom longitudinals should be such as to facilitate walking on the bottoms. Longitudinal walkways above the level of the bottom transverse members should be provided to inspect these critical areas.

Access holes to pass through the main structural elements must be such as to facilitate passage of personnel with their inspection equipment. Handholds can facilitate passage.

In the case of double hull tankers, design for inspectability and repairability is a particularly critical problem. The hulls need to be spaced not only to develop sufficient damage capacity, but as well to facilitate access for inspections and repairs. For each particular hull configuration, significant design engineering should be devoted to defining the structure to accommodate the needs for safe personnel access to perform inspections and perform repairs to coatings, and cracked and buckled elements.

Design for inspectability should also include structural appurtenances and openings to facilitate personnel access during inspections (e.g. trolley rails and other attachments to accommodate access scaffolding that can be moved horizontally under the deck members, and vertically along the sides and bulkhead; deck openings of sufficient size to accommodate installation of the inspection and maintenance equipment). Design for inspectability should also incorporate considerations for installation and maintenance of structural monitoring equipment.

Provisions for safe and efficient lighting of the spaces to be inspected should be developed during the design. As noted in the section on coatings, the use of light colored coatings can greatly facilitate inspections.

Many of these provisions can help facilitate the construction of the vessel and lead to fabrication and injury cost savings.

Naval architects that are in charge of layouts and designs of tanker hull structures need to have direct personal experience in the inspections of these structures during their life cycle. This experience provides important insights into how the hull structure might be configured to improve the quality, safety, and efficiency of inspections.

### **Design for Constructability**

There are many aspects to design for constructability. Reference is frequently made to optimizing the design for constructability, recognizing the many and varied constraints imposed by various shipyards (plate fabrication, automatic and manual cutting and welding equipment and personnel, weather protected shops for cutting and assembly of components or blocks, graving and drydocks, launch ways).

The objective of this optimization is to assure an efficient and economic assembly of materials to result in a ship of adequate quality. This optimization must be done in the overall context of overall design of the hull structure considering factors such as speed, power requirements, and cargo - ballast - stability requirements. Some design features conducive to ease of construction are [4.52]:

- Flat surfaces instead of curved surfaces,
- Single curvature rather than compound curvature,
- Flat bottom instead of deadrise,
- Flat sheer and camber,
- Stiffened plate designs based on use of thicker plates, fewer stiffeners, fewer intersections, and less welding,

- Weld details that permit machine welding or require no back gouging,
- Assembly procedures that minimize the amount of overhead and vertical welding,
- Assembly procedures that minimize the need for scaffolding and high elevation welding (keep all welding as close to the ground as possible),
- Openings in stiffeners that permit continuous welds,
- Use of standard structural and welding details,
- Provisions for good access and ventilation.

In this particular case, present experience with durability problems in crude carriers indicates that we are concerned with how design for constructability can have a positive influence on design for durability. Present experience indicates that there are two primary considerations:

- 1) Design for adequate fabrication fit-up tolerances (individual elements and block components), and
- 2) Design for cutting and welding (to maximize machine and minimize hand welding and cutting).

Design for adequate fabrication fit-up tolerances refers to configuration of the interconnecting details so that these tolerances do not lead to unanticipated durability problems. Unaligned vertical bulkhead and tank floor stiffeners between two different blocks that intersect over welding "rat holes" have lead to a durability problem in some tankers.

Design for machine cutting and welding can pay dividends in the quality and efficiency of construction. The shipyard must have the equipment and trained personnel to operate the equipment. The structural designer must have the experience and training to know how the structure can be configured to facilitate machine based fabrication. Minimizing intersections of stiffening elements and components, reductions in the number of pieces to be cut and handled through structural simplifications are examples of design for constructability. These designs must be done properly so that the gains in constructability are not done at the expense of hull structure capacity and durability.

Naval architects that are in charge of layouts and designs of tanker hull structures need to have direct personal experience in the construction and maintenance of these structures. This experience provides important

insights into how the hull structure might be configured to improve the quality, safety, and efficiency of construction and maintenance.

### Design for Damage Tolerance

The hull structure of tankers and crude carriers are highly redundant and generally "robust." **Robustness refers to the ability of the primary hull structure system to tolerate or sustain damage or defects without significant loss in strength or serviceability. Robustness is derived from a combination of redundancy (degree of indeterminacy), ductility (ability to sustain large plastic strains without significant loss in strength), and excess capacity (ability of alternative load paths to carry loadings from failed elements or components) [4.53].**

The hull structure of tankers are essentially multi-celled box beam structure systems which have internal longitudinal divisions that subdivide the cross section into multiple closed cells. The longitudinal hull girders and bulkheads, transverse bulkheads, and external shell (sides, bottom, deck) comprise the box beam structure. The external and internal plate surfaces are stiffened longitudinally and transversely as implicated by the loading and support conditions of the surfaces. This is a complex and highly redundant structural system that entails thousands of elements and connections.

In terms of structural damage tolerance, tanker hull structures have proven through service experience to be extremely robust. As future designs are "optimized" [e.g. 4.54] and modified to improve construction and maintenance characteristics, it will be important to see that robustness is not sacrificed to the point where damage and defect tolerance becomes a significant problem; this has already happened in other sectors of the marine industry.

Design for damage tolerance not only has implications for the durability of the ship hull structure but as well for its ability to perform acceptably during accidents such as collisions and groundings. In the first case, robustness is needed to provide structural strength and integrity in the case of unanticipated degradation (fatigue, corrosion) and defects (construction) in the internal structural elements. In the second case, robustness is needed to provide structural strength and integrity for unanticipated external events (collisions, groundings). Additional work is needed to determine how best to provide sufficient external damage tolerance in tankers [4.55].



---

## Structural Design Plans

---

As indicated in the review of ASIP and definition of an advanced MSIP, the first step of structural design of a particular class of crude carrier should be development of a comprehensive set of sufficiently detailed plans, specifications, and drawings that address:

- **Design criteria,**
- **Maintenance criteria,**
- **Rules, guidelines, and specifications,**
- **Loading analyses,**
- **Material selection and fabrication procedures,**
- **Stress analyses,**
- **Damage tolerance analyses,**
- **Durability analyses,**
- **Design development testing programs,**
- **Design documentation, and**
- **Construction drawings.**

These plans should form the basis for the design, construction, operation, and Classification (approval for operations) of the vessel. These plans should also be a primary component of the information system (Chapter 6) that will be used to track particular ships through their life cycles. Determination of the suitability of these plans for a proposed service will be based on Classification Rules, and economic and reliability considerations by the vessel owner/operator (Chapter 7).

---

## Summary

---

This chapter has addressed the principal improvements in structural design methods and procedures that can result in improved MSIP. These improvements include:

- Provision of high quality corrosion protection in ballast and cargo tanks (durable coating and cathodic protection systems);

- Implementation of first-principle S-N based fatigue design methods for CSD;
- Renewed emphasis on design and laboratory fatigue testing of "improved" CSD (employing current materials and fabrication procedures) and vessel monitoring systems to provide essential data to verify loading and performance analyses;
- Development of design guidelines to facilitate inspections and construction (enhancement of durability by providing improved inspectability and constructability); and
- Development of design methods and procedures to assure adequate damage tolerance and robustness in the hull structure system.

---

**References**

---

- [4.1] Pollard, Rob Roy (1991). *Evaluation of Corrosion Damage in Crude & Product Carriers*. Project Report No. SMP-2-1, Structural Maintenance for New and Existing Ships, Dept. of Naval Arch. & Offshore Eng., Univ. of Cal., Berkeley.
- [4.2] Ohyagi, M. (1987). *Statistical Survey on Wear of Ship's Structural Members*. NK Technical Bulletin; also *Statistical Survey on Wear of Ship's Structural Members by Thickness Measurement Data*. Research Institute of Nippon Kaiji Kyokai (1983).
- [4.3] Huang, Rong (1990). *Corrosion Rate Determination*. Report to Tanker Structure Cooperative Forum.
- [4.4] Exxon Corporation (1982). *Large Oil Tanker Structural Survey Experience, A Position Paper by Exxon Corporation*. Report to Tanker Structure Cooperative Forum.
- [4.5] Tanker Structure Cooperative Forum (1984). *Factors Contributing to Corrosion*. Final Report of Project 102.
- [4.6] Herring, L. C. and Titcomb, A. N. (1981). *Investigation of Internal Corrosion and Corrosion Control Alternatives in Commercial Tankers*. Ship Structure Committee Report SSC-312.
- [4.7] Munger, C. G. (1976). *Deep Pitting Corrosion in Sour Crude Oil Tankers*. Materials Performance.

- [4.8] Emi, H., Kumano, A., and Baba, N. (1991). *A Study on Hull Structures for Ageing Ships. Proceedings of the Marine Structural Inspection, Maintenance, and Monitoring Symposium*, Arlington, Virginia.
- [4.9] Balczewski, J. T. (1990). *Fatigue and Corrosion in VLCCs*. Paper Presented At 12th Annual Industrial Liaison Program, Univ. of Cal. at Berkeley.
- [4.10] Stambaugh, K. A. and Wood, W. A. (1991). *Part 1 - Ship Fracture Mechanisms Investigation*. Ship Structure Committee Report SSC-337
- [4.11] Berge, S., et al (1989). *Effect of Localized Corrosion Damage on Fatigue Strength of Welded Steel Joints. Proceedings, International Conference on Evaluation of Materials for Corrosive Environment*, Kobe, Japan.
- [4.12] Engesvik, K and Berge, S. (1971). *Pitting Corrosion - Fatigue, Sub-Project 1.1: State of the Art*. SINTEF Report STF71 F85036.
- [4.13] Tanker Structure Cooperative Forum (1990). *Inspection, Assessment and Experience of Older Tankers*. TSCF Work Group Report.
- [4.14] Chen, Y-K. (1991). *Corrosion Margins for Oil Tankers*. Project Report No. SMP 2-2, Structural Maintenance for New and Existing Ships, Dept. of Naval Arch. & Offshore Eng., Univ. of Cal., Berkeley.
- [4.15] Nippon Kaiji Kyokai (1990). *Comparison of Corrosion Margins*. Report to Tanker Structure Cooperative Forum.
- [4.16] Research Committee for the Prevention of Ship Corrosion (1987). *A Summary of "Guide to Protection Against Corrosion of Ship's Hull and Equipment."* NK Technical Bulletin
- [4.17] Munger, C.G. (1990). *Corrosion Protection by Protective Coatings*. National Association of Corrosion Engineers, Houston, Texas.
- [4.18] Steel Structures Painting Council (1989). *Good Painting Practice, Steel Structures Painting Manual, Volume 1*. Pittsburgh, Pennsylvania.
- [4.19] Steel Structures Painting Council (1989). *Systems and Specifications, Steel Structures Painting Manual, Volume 2*. Pittsburgh, Pennsylvania.
- [4.20] Choate, D. L. and Kochanczyk, R. W. (1991). *Specifications for the Selection and Application of Paint Systems for Offshore Facilities. Proceedings of the Offshore Technology Conference*. Paper No. OTC 6596.
- [4.21] Skaar, K. T., Aage, C., Ashe, G. M. Babinet, J., Bea, R. G., Clarke, J. D., Gnone, E., and Nitta, A. (1991). *Inspection, Monitoring, Maintenance /*

*Repair. Proceedings of the 11th International Ship and Offshore Structures Congress*, Report of Committee V.2, China.

[4.22] Ternus, R. A. (1990). *Inspection and Maintenance of the Chevron Tanker Fleet. Proceedings of the Sea Grant Symposium on Preservation of Ageing Marine Structures*, Univ. of Cal. at Berkeley.

[4.23] Tanker Structure Co-operative Forum (1986). **Guidance Manual for the Inspection and Condition Assessment of Tanker Structures**. International Chamber of Shipping Oil Companies International Marine Forum, Witherby & Co. Ltd., London, 1986.

[4.24] Schulte-Strathaus, R. (1991). *Fatigue Database Development and Analysis*. Project Report No. SMP-1-1, Structural Maintenance for New and Existing Ships, Dept. of Naval Arch. & Offshore Eng., Univ. of Cal., Berkeley.

[4.25] Bea, R. G., Pollard, R. R., Schulte-Strathaus, and Baker, R. K. (1991). *Structural Maintenance of New and Existing Ships. Proceedings of the Marine Structural Inspection, Maintenance, and Monitoring Symposium*, Arlington, Virginia.

[4.26] Letcher, J., Shook, D., and Sucharski, D. (1991). *A Graphical Database for Hull Fracture Reports. Proceedings of the Marine Structural Inspection, Maintenance, and Monitoring Symposium*, Arlington, Virginia.

[4.27] Jordan, C. R., and Knight, L.T. (1980). *Further Survey of In-Service Performance of Structural Details*. Ship Structures Committee Report No. 294.

[4.28] Jordan, C. R. and Cochran, C.S. (1978). *In-Service Performance of Structural Details*, Ship Structure Committee Report No. SSC-272.

[4.29] Skaar, K. T., Sverre Valsgård, Köhler, and Mürer (1987). *How Low Can Steel Weight Go with Safety and Economy? Proceedings, Third Int. Conference on Practical Design of Ships and Mobile Offshore Units, PRADS' 87*, Trondheim, Norway.

[4.30] Köhler, P. E. and Valsgård, S. (1987). *Advanced Ship Structural Design and Maintenance, Proceedings, Third Int. Conference on Practical Design of Ships and Mobile Offshore Units, PRADS' 87*, Trondheim, Norway.

[4.31] Ferguson, J. (1989). *Extending the Life of Existing Tanker Hulls: Structural Trends in Today's Tanker Newbuildings, The Lloyd's Register Forum on Crude Oil Carriers in the 1990s*, London, England.

- [4.32] Purtell, T.W., Mielke, T.C., and Brusseau, J.P. (1988). ***Marine Structural Casualty Study***, Report to the Marine Inspection Program Casualty Review Council, U.S. Coast Guard, Washington, D.C.
- [4.33] Wirsching, P.H., and Chen, Y.N. (1987). ***Considerations of Probability-Based Fatigue Design for Marine Structures. Proceedings, Marine Structural Reliability Symposium***, Arlington, Virginia.
- [4.34] Chen, Y.N., and Mavrakis, S.A.(1988). ***Closed-Form Spectral Fatigue Analysis for Compliant Offshore Structures***. Journal of Ship Research, Vol. 32, No. 4.
- [4.35] Thayamballi, A.K., Chen, Y-K, and Chen, H-H (1987). ***Deterministic and Reliability Retrospective Strength Assessments of Oceangoing Vessels***, SNAME Annual Meeting.
- [4.36] Thayamballi, A., Chen Y-K., and Liu, D. (1984). ***Fracture Mechanics Based Assessment of Fatigue Reliability in Ship Structures***. SNAME, Ship Structure Symposium '84.
- [4.37] Munse, W.H., Wilbur, T.W., Tellalian, M.L, Nicoll, K., and Wilson, K. (1983). ***Fatigue Characterization of Fabricated Ship Details for Design***, Ship Structures Committee Report SSC-318.
- [4.38] Lawrence, F.W. (1991). ***Fatigue Characterization of Fabricated Ship Details - Phase II***. Ship Structures Committee Report SSC-345.
- [4.39] Stambaugh, K. A., Leeson, D. H., Lawrence, F., Hou, C-Y, and Banas (1991). ***Reduction of S-N Curves for Ship Structural Details***. Ship Structures Committee Draft Report (Project SR-1336).
- [4.40] Det Norske Veritas (1984). ***Fatigue Strength Analysis for Mobile Offshore Units. Classification Notes***, Note No. 30.2, Høvik, Norway.
- [4.41] Chen, Y. N. and Thayamballi, A. K. (1991). ***Consideration of Global Climatology and Loading Characteristics in Fatigue Damage Assessment of Ship Structures. Proceedings Marine Structural Inspection, Maintenance and Monitoring Symposium***, Arlington, Virginia.
- [4.42] Huss, M. (1987). ***Combined Wave Induced Stresses in a Lo/Lo Container Ship, Application of a Rationally Based Direct Calculation Method, Part 1***, Report TRITA-SKP 1059, The Royal Institute of Technology, Stockholm, Sweden.
- [4.43] Huss, M. (1990). ***Combined Wave Induced Stresses in an OBO Carrier, Application of a Rationally Based Direct Calculation Method, Part 2***, Report TRITA-SKP 1065, The Royal Institute of Technology, Stockholm, Sweden.

- [4.44] Huss, M. and Lidvall, G. (1990). ***Prediction of Combined Long-Term Wave Induced Stresses and Corresponding fatigue Damage in a Ship's Bottom Girder, Application of a Rationally Based Direct Calculation Method, Part 3***, Report TRITA-SKP 1059, The Royal Institute of Technology, Stockholm, Sweden.
- [4.45] Beghin, D. (1991). ***Comparative Fatigue Behaviour of Structural Details of VLCCs. Proceedings Marine Structural Inspection, Maintenance and Monitoring Symposium***, Arlington, Virginia.
- [4.46] Paliou, C., and Shinozuka, M. (1988). ***Reliability and Durability of Marine Structures***. Final Technical Report, ABS Contract No. CU00396501, Columbia University, 1986.
- [4.47] Madsen, H.O., Tallin, A.G., and Kirkemo, F. (1987). ***Probabilistic Fatigue Crack Growth Analysis of Offshore Structures, with Reliability Updating Through Inspection, Proceedings, Marine Structural Reliability Symposium***, Arlington, Virginia.
- [4.48] Cramer, E. H., and Bea, R. G. (1991). ***Fatigue Reliability Model for Inspection, Updating, and Repair of Welded Geometries, Proceedings, Marine Structural Inspection, Maintenance, and Monitoring Symposium***, Arlington, Virginia.
- [4.49] Cramer, E. H., Hauge, L. H. (1991). ***A Maximum Utility Model for Structures Subject to Fatigue Crack Growth," Proceedings, Marine Structural Inspection, Maintenance, and Monitoring Symposium***, Arlington, Virginia.
- [4.50] Ferguson, J. M. (1991). ***Some Considerations Regarding Tank Inspection Priorities for Oil Tankers. Proceedings Marine Structural Inspection, Maintenance and Monitoring Symposium***, Arlington, Virginia.
- [4.51] Patofatto, G. (1991). ***The Evolution of Inspection and Repair Procedures for Ship Structures. Proceedings Marine Structural Inspection, Maintenance and Monitoring Symposium***, Arlington, Virginia.
- [4.52] Acker, H. G., and Bartlett, F. G. (1980). ***Ship Construction, Ship Design and Construction***, R. T. Taggart (Editor), Society of Naval Architects and Marine Engineers.
- [4.53] Das, P. K. and Garside, J. F. (1991). ***Structural Redundancy for Discrete and Continuous Systems***, Final Draft Report of Project No. SR-1316, Ship Structure Committee.

[4.54] Hori, T., Sekihama, M., and Rashed, S. H. H. (1990). *Structural 'Design-by-Analysis' Approach Applied to a Product Oil Carrier with a Uni-Directional Girder System*, The Royal Institution of Naval Architects, Paper No. 8.

[4.55] Committee on Tank Vessel Design (1991). *Tanker Spills: Prevention by Design*, Marine Board, National Academy of Engineering, National Academy Press, Washington, D.C.

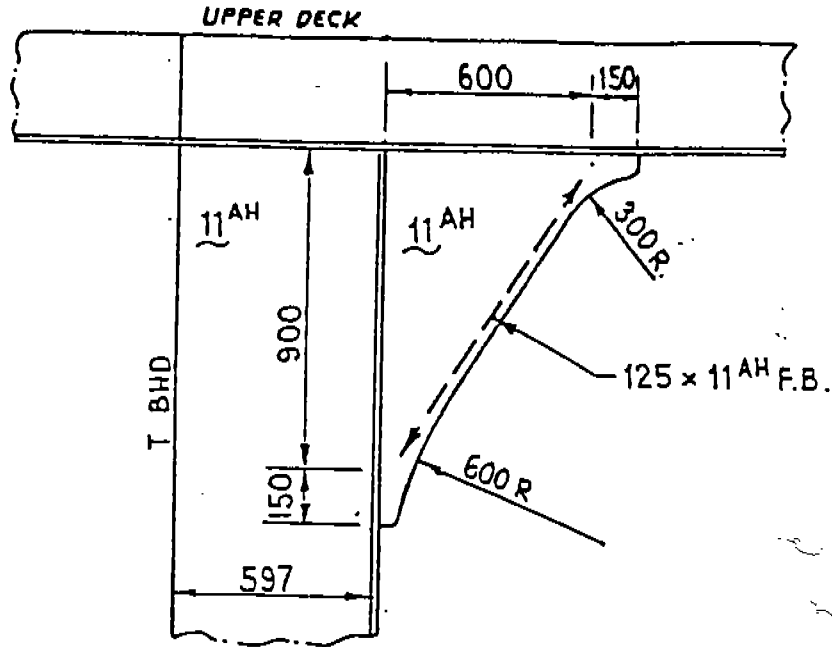
**Table 4.1 - Coating Protection Mechanisms and Types**

Protection Mechanism	Coating Types
Low permeability film reducing permeation of water and ions to the metal surface.	<ul style="list-style-type: none"> <li>• Phenol paint</li> <li>• Rubber chloride paint</li> <li>• Vinyl chloride paint</li> <li>• Epoxy paint</li> <li>• Aluminum paint</li> <li>• Glass flake paint</li> <li>• Tar epoxy paint</li> </ul>
High electric resistance coating film.	<ul style="list-style-type: none"> <li>• Epoxy paint</li> <li>• Tar epoxy paint</li> <li>• Polyurethane paint</li> <li>• Glass flake paint</li> <li>• Aluminum paint</li> </ul>
Suppress the generation of electric current by arresting metal reactions and providing pigments which act as anodes.	<ul style="list-style-type: none"> <li>• Paint containing metallic powder which tend to ionize more than the base metal such as zinc paint, epoxy zinc primer, and inorganic zinc paint</li> </ul>
Form film which can withstand external abrasion.	<ul style="list-style-type: none"> <li>• Epoxy paint</li> <li>• Tar epoxy paint</li> <li>• Polyurethane paint</li> <li>• Glass flake paint</li> <li>• Inorganic zinc paint</li> </ul>

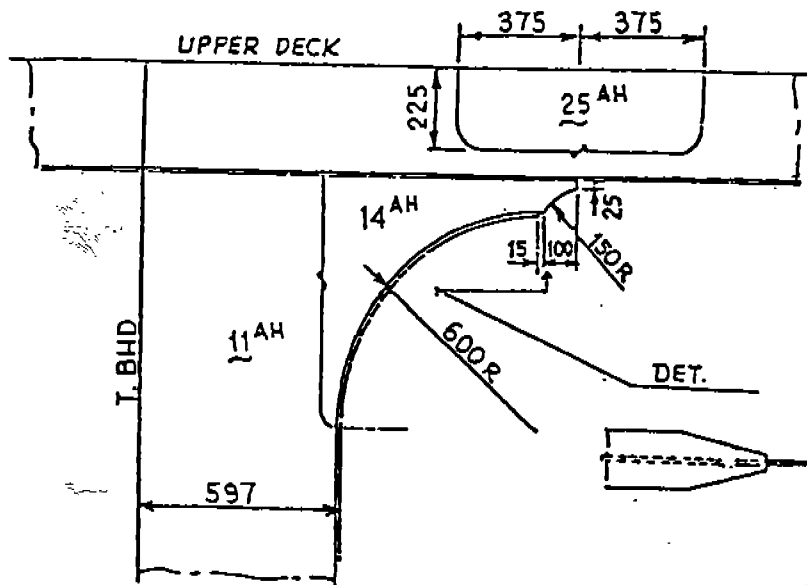
**Table 4. 2 - Fracture Control Approach for Ships**

<p><b>I. Design Goals: Specification of Strength &amp; Fracture Resistance Properties</b></p> <p>A. Determine / estimate stress distribution and related information (including operational temperatures, strain rates) and determine regions of greatest fracture hazard.</p> <p>B. Specify materials strength properties, fracture properties, recommended heat treatments.</p> <p>C. Determine flaw tolerance in regions of greatest fracture hazard.</p> <p>D. Recommend fabrication procedures, welding methods, and allowable flaw sizes.</p> <p>E. Estimate stable crack growth for typical periods of service.</p> <p>F. Recommend safe operating conditions for specified intervals between inspection from the results of A - E. This may be ship specific or ship class specific based on the first few years of service and may be greatly influenced by building yard, area of operations, etc.</p>
<p><b>II. Fabrication Goals: Protection of Specified Strength and Fracture Properties</b></p> <p>A. Develop controls for residual stress, grain coarsening, grain direction.</p> <p>B. Inspect prior to final assembly.</p> <p>C. Inspect defects using appropriate non-destructive (ND) evaluation techniques at specified times after fabrication (welding).</p> <p>D. Maintain fabrication records.</p> <p>E. Ensure no missing or unwelded details</p> <p>F. Ensure correct thickness and type of steel is used</p>
<p><b>III. Operations Goals: Maintenance of Strength Parameters</b></p> <p>A. Control the stress level and stress fluctuations in service.</p> <p>B. Maintain corrosion protection systems.</p> <p>C. Perform periodic in-service inspections as specified in I - F.</p> <p>D. Monitor growth of subcritical flaws.</p> <p>E. Repair or renew affected areas.</p>



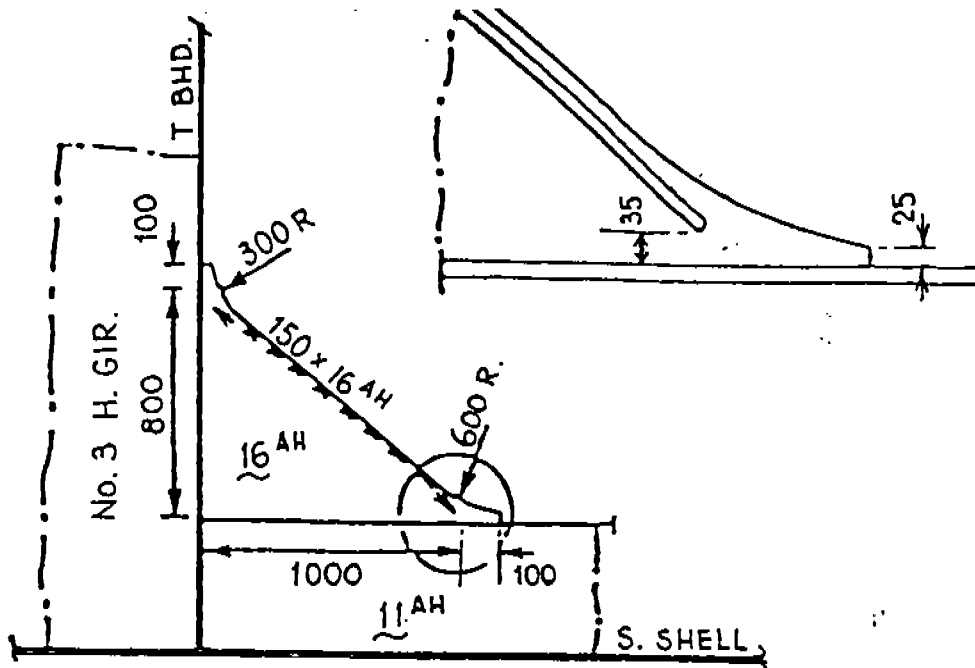


Original Design  
 EXPECTED FATIGUE LIFE 19.2 YEARS

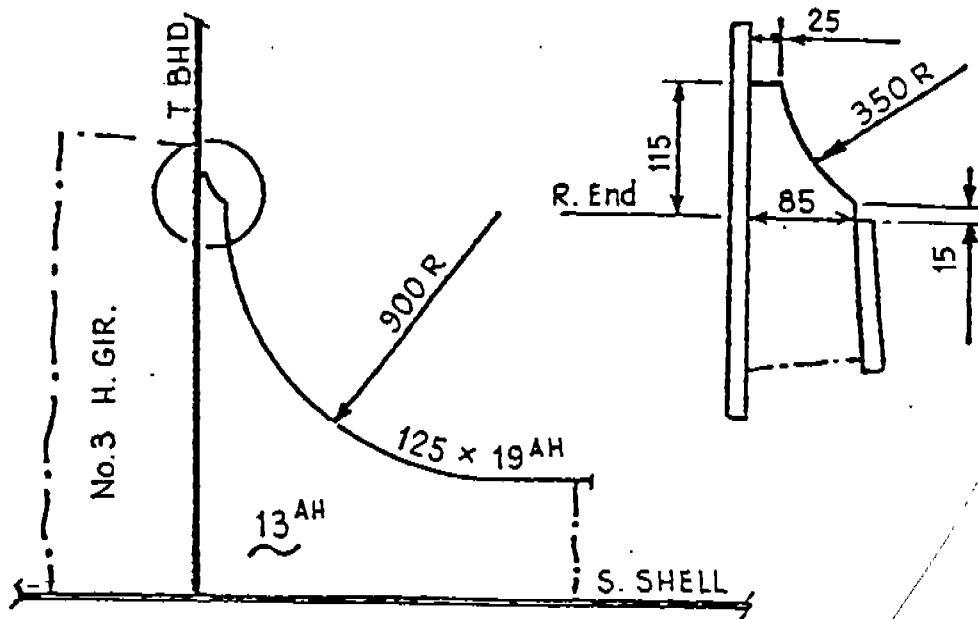


Modified Design  
 EXPECTED FATIGUE LIFE 44.4 YEARS

Figure 4.1 - Original and Improved Design of Top Bracket



Original Design  
 EXPECTED FATIGUE LIFE 5.6 YEARS



Modified Design  
 EXPECTED FATIGUE LIFE 84.7 YEARS

Figure 4.2 - Original and Improved Design of Side Shell Longitudinal Bracket

## INSPECTIONS, MAINTENANCE, REPAIRS

### Background

---

**The objective of this chapter is to develop a technical basis for preparing inspection and maintenance strategies for maintaining the structural adequacy of tanker hull structures with minimum cost for repair and replacements.**

Inspection, maintenance, and repairs (IMR) are a critical part of the structural integrity process. The IMR process must be in place, working, and being further developed during the entire lifetime of the structure. The IMR process is responsible for actually maintaining the strength and serviceability of the structure during the useful lifetime of the structure.

It is in the IMR process that the author found some of the largest differences between present ASIP for commercial and military aircraft and present MSIP for tankers. ASIP has devoted a very significant portion of its attention and resources to development, implementation, and continued improvement of IMR.

ASIP IMR is different from MSIP IMR in several important respects. It is relatively easy to thoroughly inspect an airframe in a dry, well ventilated and lighted hangar. There is a relatively small area and number of CSD to be inspected. Visual and non-destructive testing can be used to develop reliable indications of the condition of the airframe. Maintenance is largely preventative. Maintenance is based on service time. Repairs are highly engineered and inspected.

In contrast, inspections of tanker hull structures are "heroic." They are dangerous, the surfaces to be inspected are not easily accessed, and due to the large areas that must be inspected largely using visual means, the inspections are not very reliable (high likelihood of missing important damage or defects). Maintenance is largely corrective. Repairs are largely done in an ad hoc manner. Design of the repairs depends heavily on the background and experience of the personnel in charge of repairs and the time and money available to make the repairs.

The second difference regards differences in "corporate cultures" of the two industries. Since its inception, the commercial air transportation

---

## **Marine Structural Integrity Programs**

---

industry (all sectors and segments) has been focused on maintenance of a high level of safety and reliability; safe transportation of the public has been required to enable retention of profitability. High standards of technology and organization have been hallmarks of this industry.

In many cases, IMR for many MSIP for tankers has been a secondary consideration on the part of the owners/operators, and builders. Until recently, Classification Societies have focused principally on issues concerning safety of the ship, not durability. Generally, it has only been when durability problems became obvious safety problems (for the ship, the personnel, the cargo, and the environment) that the focus has changed.

An important part of development of advanced IMR processes that can lead to advanced MSIP lies with organizational issues. Responsibilities for durability and maintaining the strength and serviceability of the hull structure must be clearly understood and discharged (refer to discussion in Chapter 3). **Positive organization incentives should be provided to insure that IMR is actually performed to the level of quality that is needed.**

---

### **Precepts of IMR**

---

#### **Objective**

The IMR process is intended to preserve the capacity and serviceability of the ship structure at adequate and acceptable levels throughout the life of the ship.

#### **Scope**

The IMR process should start with the design of the vessel (conception), proceed through the life of the vessel, and conclude with its scrapping (life-cycle). The IMR process should include not only the hull structure, but as well, its equipment and its personnel (full-scope).

#### **Basis**

All things age. As things age:

- Their strength and serviceability decreases (the rate at which strength and serviceability decrease is a function of the initial strength and serviceability designed into the structure and how the structure is maintained).

- They must not necessarily be discarded (the challenge is to determine how best to maintain strength and serviceability and to choose operations that can be successfully completed).
- They become more prone to defects and damage (a primary function of the IMR process is to give early warnings of defects and damage, define alternatives to manage the defects and damage, choose the best alternative, implement alternative, and then monitor its effects).
- There comes a time for them to retire (one of the primary functions of an IMR process is to enable one to know when it is time to retire).

### **Knowledge**

A fundamental and essential part of the IMR process is knowledge. The IMR process can be no more effective or efficient than the knowledge, data, and experience that forms the basis for the process.

### **Integrity**

The IMR process must be diligent and disciplined and have integrity. There must be a focus on the quality of the performance of the process; quality of the product (strength and serviceability maintenance) will be a natural by-product.

### **Alternatives**

The IMR process should investigate a wide variety of alternatives to accomplish its fundamental objectives (maintenance of strength and serviceability). Inspections can range from general to detailed, visual to acoustic, periodic to continuous (monitoring). Maintenance can range from patching to complete replacement. Repairs can range from replacement as-was to re-design and replacement; temporary to permanent; from complete and comprehensive to judicious neglect.

The IMR process can be proactive (focused on prevention), or it can be reactive (focused on correction). The IMR process can be periodic (time based), or it can be condition oriented (occasion based). Combinations of proactive, reactive, periodic, and condition based approaches can be appropriate for different IMR programs. A major challenge is to find the combination that best fits a particular fleet, its operations, and its organizations.

### **Evaluation**

An IMR process should define the combinations and permutations of IMR that will produce the lowest total costs (initial and future) and optimize the use of resources without compromising minimum safety and reliability requirements.

### **Inspections**

---

#### **Objectives**

The fundamental purpose of inspections is to provide information and knowledge concerning the proposed, present, and future integrity of the ship hull structure.

**Inspections, data recording, data archiving (storage), and data analysis should all be a part of a comprehensive and integrated inspection system. Records and thorough understanding of the information contained in these records are a key aspect of inspection programs.**

Inspections should be focused on:

- **Determination of condition of CSD;**
- **Disclosure of defects (design, construction, maintenance);**
- **Assurance of conformance with plans and specifications, guidelines and rules, and quality requirements;**
- **Disclosure of damage,**
- **Development of information to improve design, construction, and maintenance procedures.**

Inspections can have several levels of intensity:

- General (global conditions),
- Specific (basic aspects of defects and damage),
- Detailed (precise descriptions of flaws and other items of maintenance concern).

Inspections should be life-cycle oriented and include quality assurance and control measures in:

- Design (including conception and feasibility phases),
- Construction (materials, fabrication, commissioning),
- Operations (equipment, handling), and
- Maintenance.

Inspections should be full-scope and include quality assurance and control measures in the hull structure, equipment, facilities, and personnel.

### **Procedures**

Inspections of tankers has been the subject of several recent studies [5.1, 5.2]. The Tanker Structure Co-operative Forum (TSCF) [5.3], and reference [5.1] develop comprehensive guidelines for:

- Survey requirements (as required by Class and owners),
- Types of Surveys (general and detailed condition, corrosion rate, fractures, and repairs),
- Survey safety and access,
- Ultrasonic thickness determination, and
- Technical background for surveys.

The International Association of Classification Societies (IACS) has issued a set of unified requirements for the hull surveys of oil tankers [5.16]. These requirements define a series of special surveys at approximately 5-year intervals for overall and close-up survey of tanker hull structures. The first special survey consists of inspections of one cargo wing tank, ballast wing tank and one complete transverse web frame ring. The surveys become progressively more extensive with time, with the extent being defined by the surveyor on the basis of the results of the previous and current surveys. In addition, minimum requirements are given for tank testing and thickness measurements.

Some operators go beyond the minimum requirements required by Class [5.10, 5.12, 5.18]. The additional inspections include:

- At the time of special surveys, visual inspections of additional parts of the hull structure that experience has shown could be the sites of excessive corrosion or cracking;

- Between special surveys, tanks are cleaned and inspected on ballast voyages;
- Before shipyard special surveys, gaging surveys are performed during voyages to facilitate shipyard planning;
- Trained and skilled gaging contractors are used repetitively.

The U. S. Coast Guard has recently published a draft guideline for development, use, and implementation of Critical Areas Inspections Plans (CAIPs) [5.4]. The plan requires reporting of:

- Vessel particulars;
- Historical information on failures and modifications;
- Active repair areas including type, location, occurrences, and dates and methods of repairs;
- Structural analyses;
- Evaluations of trends;
- Structural Inspections, internal and external;
- Tank Coating Systems;
- CAIP plan updating.

Survey and inspection results are to include detailed information on coatings, fractures, and other types of degradation and damage. Guidelines also have been issued for classing and reporting structural failures [5.5].

### Development of Inspection Programs

Key aspects of inspection programs include:

- **Elements to be inspected (where and how many ?);**
- **Defects, degradation, and damage to be detected (what ?);**
- **Methods to be used (how ?);**
- **Timing (when ?);**
- **Responsibility for inspections (who ?);**
- **Extent of inspections (why ?).**



**A technical basis for preparing inspection and maintenance strategies for maintaining structural adequacy is outlined in Fig. 5.1.** Each of the key elements of this basis will be described in the following parts of this Chapter.

**Where and How Many ?** - Definition of the elements to be inspected is based on two principal aspects of the performance of structural elements within the ship structure [5.2]:

- Consequences of defects and damage, and
- Likelihoods of defects and damage.

The consequence evaluation is essentially focused on defining those structural details, elements, and components (assemblies of elements and details) that define CSD. Evaluation of the potential consequences should be based on historical data (experience) and analysis (to define details critical to hull integrity).

The likelihoods evaluation is essentially focused on defining those CSD that have high likelihoods of being damaged and defective. Again, experience and analysis are complementary means of identifying such CSD.

The heart of the assessment of consequences and likelihoods is the ship database. This database should contain extensive design, construction, operations, and maintenance on the ship. Development of high quality databases on corrosion and cracking histories and containing sufficient volumes of high quality data can greatly assist in defining the areas of the hull structure that should be closely inspected and when these areas should be closely inspected. This applies to all inspections during the life cycle of the ship. More will be said on this aspect of IMR programs later in this Chapter and in Chapter 6.

Prioritization of inspections proceeds through the CSD that possess the combinations of highest likelihoods and consequences of damage and defects [5.2, 5.6]. Analytical procedures are available to assist in such prioritization [5.7-5.9]. Analytical procedures can also assist in defining the numbers of CSD that need to be inspected to given an adequate sample of all CSD [5.7-5.9].

It is important to note that the definitions of where and how much of inspections need to be flexible. The definitions need to be based on the results of a survey as they are developed. If the initial inspection results indicate unanticipated damage and defects or lack there of, then the extent and nature of the survey need to be changed to meet what is actually found.

**What ?** - The definition of defects, degradation, and damage that should be the focus of inspections again includes those that have the high-

est likelihoods and consequences relative to the strength and serviceability (integrity) of the hull structure. Evaluation of the consequences and likelihoods leads to a prioritization of what should be given the highest priorities in hull inspections.

**Corrosion** - Relative to in-service inspections, given the background of the structural durability and performance characteristics of the present generation of crude carriers, it is apparent that corrosion is the most pervasive and potentially damaging type of damage to be inspected [5.10]. Inspections for general corrosion should be focused in all parts of ballast and cargo tanks (coated and uncoated) with particular emphasis given to portions of the tank that are not filled during long service periods (upper and lower thirds) and that are adjacent to heated cargo tanks [5.11].

Inspections for localized corrosion can be focused in the areas of bellmouths, tank bottoms in areas that do not drain, in areas in which it is difficult to apply proper thickness of protective coatings, and tank tops and deckhead members [5.12, 5.13]. Bulkheads that are very flexible combined with brittle coatings and local stiffening members can become the sites of localized grooving corrosion [5.11].

**Cracking** - Given the present background on hull durability characteristics, inspection priority (design, construction, and maintenance) should be directed at side shell and forepeak elements, in particular, longitudinals and their intersections with transverse stiffening components and elements. This has been a high activity fracture problem area for many crude carriers [5.14, 5.15]. Similarly, fracture problems associated with bilge keels, very flexible bulkheads (combined grooving corrosion and flexure fatigue cracking), and tank top and deckhead elements associated with deck equipment and piping systems (causing local vibrations and marked changes in local hull stiffness) are sites to be carefully inspected.

The synthesis of the definition of highest consequence and highest likelihood CSD locations, and the damage and defects to be inspected results in the definition of critical areas to be inspected (Fig. 5.1)

**How ?** - The methods to be used in construction and in-service inspections of CSD are chiefly visual [5.2, 5.16]. Table 5.1 summarizes present alternative tank (ballast, cargo) internal inspection methods [5.17]. In one form or another, these inspection methods are primarily focused on getting an inspector close enough to the surface to be inspected so that he can visually determine if there is are significant defects or damage.

Tank conditions, surface cleaning, and lighting are primary considerations [5.1-5.3]. As important are inspector training, stamina, and diligence. Data recording is chiefly based on paper, pencil, and if tank conditions permit, photography. Tank conditions fundamentally are dangerous; there are hazardous gases that must be removed, it is dark and wet, sur-

faces are slippery, and one must climb or be lifted (rafting partially filled tanks, or using scaffolding) to access the surfaces [5.10, 5.16].

Inspections of CSD during construction pose similar problems. In a large VLCC there can be:

- 150 to 200 acres of steel,
- 200 to 300 miles of welds, and
- 30 to 40 miles of stiffeners to be inspected.

There are several well documented cases where CSD in the current generation of VLCCs have been found during the first special survey (5 years) not to be completely welded (tack welded in place and final welding never performed). Substantial misalignments of CSD have been accepted by the owner in the rush to get the ship commissioned. These later developed into substantial durability problems.

It is fundamentally because of the present problems associated with construction and maintenance inspections and their low reliability, that the results of this study have recommended that in-service inspections not be used as a primary means for assuring the durability of the hull structure. The durability must be assured with design, and construction and maintenance quality assurance and control.

**In-service inspections become the means to detect unexpected flaws and damage, and permit appropriate measures to be taken to preserve the integrity of the hull structure. In-service inspections are also the means to assure that all is going as expected, that the CSD are performing as expected, and that corrosion protection and mitigation (e.g. patching pits, renewing locally excessively corroded plate) is being maintained.**

Inspection instrumentation systems need to be further developed and made practical for use in hull structure inspections. Ultrasonic gaging, magnetic particle, and radiographic survey equipment needs continued development to improve the utility of the data and the ease of acquiring meaningful data. Refer to Table 5.2 for a summary of hull structure weldments non-destructive testing methods, equipment, advantages and limitations.

As well, other inspection technologies need to be investigated and as shown to be practical and useful, implemented into ship hull inspections. Acoustic monitoring and infra-red photographic methods appear to be promising [5.19].

As important as instrumentation developments are developments in the inspector access and recording aspects. For the foreseeable future, visual and optical techniques will continue to be the mainstay of inspections. Major improvements are needed in providing safe and workable access for

the inspector to the CSD. Rafting and free-climbing tanks leave much to be desired. In addition, data recording techniques need to be radically improved. Pencils and wet paper and memories leave much to be desired. Digital voice data collection and photographic technologies need to be explored [5.19].

Hull structural monitoring systems are a potentially important part of tanker inspection technology. Such systems have been the recent object of SSC sponsored research [5.20]. Lloyd's Register has developed a hull monitoring system that is being tested [5.15].

More hull structure monitoring research and development is needed to improve MSIP and hull durability. These systems can provide intermittent and continuous data on the performance characteristics of the hull. These systems can provide important information to improve design, construction, and operations of the ship. As noted earlier in this report, ASIP use hull monitoring systems for similar purposes, and in addition, to assure that the hull structure operating envelopes are not exceeded. Thus, the ship operations crew and master need to be given practical and reliable information that can be used to limit unnecessary excursions of the hull structure. In addition to accelerometer and strain gage based instrumentation, simple mechanical instrumentation such as fatigue gages and scratch strain gages need to be more extensively utilized.

Once the inspection methods to be used have been defined, the inspection data recording and analysis system should be defined. This system should be defined to cover the period from the time the surveyor or inspector enters the ship until the data is archived in the ship data base. Such planning can pay major dividends in avoiding inefficiencies in the data recording, translating (to the database), and analysis.

As well, the analysis or evaluation of the inspection data should be carefully defined. Definition of "limits" (corrosion allowables, crack sizes and locations that must be repaired as soon as possible and those that can be monitored) and data statistics methods (how the data can best be portrayed to assist decisions concerning maintenance of CSD) should be accomplished before the preparation of the survey specifications. In many cases the recording and analysis system will define important aspects of the specifications. Note that this system becomes part of the ship database (Fig. 5.1).

**When ?** - Ship Classification Rules provide minimum requirements on inspections periods; generally special surveys are scheduled every five years. Conscientious operators schedule inspections on much more frequent intervals. In some cases, when the ship has had serious durability problems, surveys have been required on an annual basis [5.21].

There are no general answers to the timing of inspections. The timing of inspections are dependent on:

- The initial and long-term durability characteristics of the ship hull structure;
- The margins that the operator wants in place over minimums so that there is sufficient time to plan and implement effective repairs;
- The quality of the inspections and repairs; and
- The basis for maintenance - "on demand" (repair when it "breaks or leaks" or "programmed" (repair or replace on standard time basis).

Ships that have been designed and constructed for durability can be expected to have longer periods of time between inspections than those that have not been designed and constructed for durability (Fig. 5.2).

Ships that are maintained so as to permit evaluation and planning time in advance of the next IMR will have more frequently scheduled inspections than those that wait until the minimums are reached and then must immediately affect repairs (Fig. 5.3).

Badly repaired ships would implicate more frequent inspections to keep the ship above minimums (Fig. 5.3). Poorly conducted inspections would have similar effects.

If IMR is conducted on a demand basis (fix it when it breaks), then periods between inspections will generally be longer than for IMR that is conducted on a periodic basis (fix it before it breaks) (Fig. 5.4). Unscheduled out of service periods and costs will be a major differential in these two approaches.

**Who ?** - The fundamental responsibility for inspections should rest with the ship owners/operators [5.10, 5.12, 5.15, 5.16, 5.18]. Company inspectors, inspection service firms, ship and repair yard inspectors, Classification Society surveyors, and regulatory authority inspectors should provide high quality assistance to the owners/operators to assure that the objectives of the inspections are met.

Inspectors and surveyors representing owners/operators, classification societies, constructors/repairers, regulators, and inspection agencies need to be well trained. As in ASIP there should be inspector training and certification programs to help assure the necessary quality in inspections. Adequate compensation and professionalism needs to be stressed. At the present time, there seems to be too few skilled and diligent inspectors to meet the needs of this industry. A system of Designated Inspection Representatives (DIRs) could be considered to help relieve this shortage.

---

## **Marine Structural Integrity Programs**

---

**Why ?** - The extent and intensity of an inspection program can be evaluated as a function of the costs that are associated with alternative IMR programs and the minimum Class requirements. This question will be addressed in greater detail in Chapter 7.

The basic answer to this question can be simply illustrated (Fig. 5.5). As IMR quality (extent and frequency of inspections, durability of repairs, etc.) is increased, initial costs are increased. Conversely, future costs associated with lost service, damages, and higher costs associated with unscheduled repairs are decreased as IMR quality is increased. The objective is to define the "best" IMR program that will keep the strength and integrity of the ship in the lowest total cost range and still exceed minimum Class requirements.

---

## **Maintenance & Repairs**

---

### **Objectives**

The basic objective of structural maintenance is to prevent unwarranted degradation in the strength and serviceability of the hull structure. Structural maintenance is directed primarily at preventing excessive corrosion through the maintenance of coatings and cathodic protection systems. Preservation of coatings in ballast spaces is the primary line of defense in corrosion protection.

Another objective of structural maintenance is to preserve the integrity of the structure through judicious renewals of steel and repairs to damaged elements.

The basic tenant of maintenance is that it must be vigilant and continuous if unpleasant surprises in degradation of the ship hull structure are to be avoided.

### **Strategies**

Maintenance can be preventative or it can be reactive (Fig. 5.4). Both strategies have their place in development of an advanced MSIP. For example, preventative maintenance can be directed at corrosion protection of CSD or fatigue damage to rudder bearings and supports. Reactive maintenance can be directed at repairs to accidental damage and unanticipated fatigue damage to CSD.

Maintenance can be continuous or it can be periodic. In general, for CSD in MSIP, it is periodic and is predicated upon the results of annual or

more frequent in-service inspections and special surveys. This is the same strategy used in ASIP.

### Repairs

Repairs to critical internal structural details is a difficult and demanding task for ship owners, operators, repair yards, surveyors, and inspectors alike. There is no reasonable consensus on what, how, and when to repair. The general lack of readily retrievable and analyzable information on repairs and maintenance frustrates repair and maintenance tracking. Many fracture repairs appear to be ineffectual. Veeing and welding cracks that have occurred early in the life of the ship seems to be ineffective in many cases; they quickly develop again. Attempts to make temporary repairs (e.g. cold patching) serve too long can result in costly down time due to unexpected cargo losses.

The general strategy used in repairing a vessel is based on the following considerations.

- **The design life of the vessel.** Typically for tankers this is approximately 20 years. As the vessel approaches the end of economic life, the operator generally will spend less money for repairs and maintenance. The emphasis will be on making minimal repairs needed to keep the vessel in class.

- **Second hand values as determined by the supply and demand for tonnage for a vessel of a particular size.** The current and anticipated demand for tonnage is dictated by the domestic and international oil markets. Another major factor is the cost for new builds which has had an economic substitutional effect on second hand values which has recently received a lot of attention. The rise in second hand values encourages ship owners to invest more in maintaining their current ships and taking a longer term approach toward repairs. The object of this effort is to delay the purchase of expensive new builds.

- **Future plans of the company for retention of the ship.** Marketing and refining logistics change with time. Maintenance expenditures for steel and coating repairs are reduced when the operator decides that the vessel may not longer fit in their logistics strategy. Oil companies with U.S. flag tanker operations are faced with the projected decline of the Alaska North Slope crude oil trade due to decreasing production in that field. Independent tanker operators of U.S. flag vessels also face this issue.

- **Availability of funds for maintaining and repairing vessels.** During the first half of the 1980's the tanker owners and operators faced economic crisis. Huge financial losses by both oil company and independent operators alike reduced the availability of cash for repairs and main-

taining their vessels. Owners were forced to make minimum investments for repairs and maintenance.

- **Environmental issues.** Increased international concern over environmental issues particularly tanker oil spills have prompted ship owners to increase their efforts in maintaining hull structural integrity.

**Procedures** - The inspection process prior to the vessel entering the shipyard varies depending upon the owner. For some owners, several months before the vessel is scheduled for the repair yard, an initial visual survey is conducted by the ships staff, the shoreside technical staff and an independent surveyor. A gaging survey may also be conducted to quantify the degree and extent of steel wastage.

Based on the results of the survey, a repair plan is written up and an estimate is made of the cost. The repair plan is then submitted to shipyards for bids. The contract is then awarded to the shipyard which makes the best offer. Once the ship enters the shipyard, visual, and as necessary, gaging surveys are again conducted. These follow-up surveys usually reveal additional repair items since all the tanks are free of cargo and ballast. Repairs are then made on items listed in the repair contract as well as any additional items discovered during the repair operations.

During the repair phase, shipyard time and budgeting have a major influence on the type of repairs made. If the work falls behind schedule or if budgeted funds are redirected for more critical needs, changes in the repairs approach may be made from the original repair specifications drawn at the office. For example, to re-weld a fracture and omit the installation of fabricated reinforcement brackets. After repairs are completed finalization of accounts may occur long after the ship has departed.

Not all repairs are sound from a naval architectural standpoint [5.22]. Many operators make repairs using experienced based rules of thumb approaches. In many cases, cracks begin to reappear during the next inspection.

Often there are differences in the repairs proposed by the office technical department and what is actually done at the shipyard. This is due to either differences in opinion or budget and time constraints at the shipyard. Many of the repairs resulted in re-cracking.

Not all cracks are or can be repaired when they are found. Given present day inspection procedures and methods, it is highly unlikely that all significant cracks can be discovered. However, significant attention is given to the side shell, bottom and tank top structural elements. Cracks in the side shell and in the major structural members are repaired using temporary (e.g. end drilling cracks) or permanent methods. In many cases, it has been observed that cracking is initiated by corrosion (e.g. grooving corrosion in tank stiffener welds) or exacerbated by corrosion.



A common cracking problem in tankers is at the intersection of the side shell longitudinals at the web frames and transverse bulkheads. In one class of ships, two ship operators tried three different approaches in bracket and detail design to solve such problems. One set of details were repaired three different times. Cracking started during the first few years of operations of these ships. Causes can be traced directly to improper design, ignored or unknown loadings and loading effects, and poor construction.

Corrosion protection philosophies vary greatly between tanker operators with regard to the use of tank coatings and anodes. Each operator has different histories of trial and error approaches that has evolved into their corrosion protection philosophies. Surface preparation of the coating areas during the initial coating of the newly built vessel seems to be the key ingredient in getting the maximum life for tank coatings. Coverage of anodes in ballast tanks with sediments accumulated in the tanks seems to be a key problem decreasing the effectiveness of anodes.

Repairs of cracks and coatings varies widely. Repairs of cracks can range from temporary cold patches to complete re-design of the detail and replacement of steel in the vicinity of the detail. Welding cracks is a popular repair that data indicates frequently must be repeated within a short period of time [5.2, 5.22].

Drilling the ends of the cracks is a frequently used temporary repair measure that is used until the ship can be taken into the drydock. Repairs of these cracks can range from simple welding to addition of reinforcing elements. Experience [5.22] indicates that many of these repairs must be repeated in subsequent dry dockings. In one case, a series of side-shell longitudinal cracks has been repaired four times, and each time a different repair procedure has been tried.

Many of the repairs identified by the TSCF [5.3] are not followed. Repairs identified by the TSCF as being unsuccessful are being used in current repairs. There is a wide variety of opinions on how repairs should be made, ranging from very high quality to very low quality. There is a range of opinions concerning the needs for repairs to deformed plate panels [5.23]. Experience indicates that high cost repairs do not necessarily translate to high durability repairs.

Repairs accepted by one Classification Society surveyor or Coast Guard inspector for a given ship at given time and location may not be accepted by another for the same ship at a different time and location. Repairs specified by the owner - operator maintenance personnel sometimes will be modified in the shipyard due to budget and time limitations. In many cases, very little engineering or structural analysis goes into the specification of repairs, even in the case of critical structural elements.

---

## Marine Structural Integrity Programs

---

**Observations** - By in large, repairs to CSD are determined by the repair yard superintendent. They are based primarily on the experience of the repair yard personnel, the inspector, and regulatory personnel (USCG). This experience varies widely, thus, repairs vary widely. Class Rules give some guidelines for renewing plates that have been excessively corroded.

It is unusual that any significant engineering goes into determining how to make the repairs. In several cases reviewed by the author, repairs that were engineered were far from successful, and in one case the repairs to several hundred CSD had to be repeated three times; the problem was moved from one place to another.

To overcome this state of affairs, the maintenance and repair of crude carriers needs to be elevated to a "first class citizen" role. Repairs and repair operations need to be engineered using the same methods and procedures discussed in Chapter 4 for improving the durability characteristics of hull structures.

---

## Summary

---

This chapter has developed a technical basis for the formulation of IMR strategies that are a part of MSIP (Fig. 5.1).

Guidelines have been provided for answering the issues of where, what, how, when, and why of inspections. Significant development efforts need to be directed at improvements in inspections, ranging from equipment to data recording systems.

Maintenance and repair engineering for CSD in tankers is not highly developed. The structure design procedures and methods discussed in Chapter 4 to improve the corrosion and fatigue durability of these vessels should be used during maintenance and repair cycles.

---

## References

---

- [5.1] Basar, N. S., and Jovino, V. W. (1990). *Guide for Ship Structural Inspections*, Ship Structure Committee Report No. SSC-332.
- [5.2] Skaar, K. T., Aage, C., Ashe, G. M., Babinet, J., Bea, R. G., Clarke, J. D., Gnone, E., and Nitta, A. (1991). *Inspection, Monitoring, Maintenance / Repair. Proceedings of the 11th International Ship and Offshore Structures Congress*, Report of Committee V.2, China.

- [5.3] Tanker Structure Co-operative Forum (1986). ***Guidance Manual for the Inspection and Condition Assessment of Tanker Structures.*** International Chamber of Shipping Oil Companies International Marine Forum, Witherby & Co. Ltd., London, 1986.
- [5.4] U. S. Coast Guard (1991). ***Critical Areas Inspection Plans (CAIPs), Navigation and Vessel Inspection Circular No. (Draft),*** COMDTPUB P16700.4, NVIC.
- [5.5] U. S. Coast Guard (1990). ***Classing and Reporting of Structural Failures, MVI No. 09-90.***
- [5.6] The Marine Technology Directorate Limited (1989). ***Underwater Inspection of Steel Offshore Installations: Implementation of a New Approach.*** MTD Ltd Publication 89/104, London, U.K.
- [5.7] Cramer, E. H., Hauge, L. H. (1991). ***A Maximum Utility Model for Structures Subject to Fatigue Crack Growth," Proceedings, Marine Structural Inspection, Maintenance, and Monitoring Symposium,*** Arlington, Virginia.
- [5.8] Sletten, R., Mjelde, K., Årstein, F., and Lotsberg, I. (1982). ***Optimization of Criteria for Design, Construction and In-service Inspection of Offshore Structures Baed on Resource Allocation Techniques, Proceedings European Petroleum Conference.*** EUR 332, London.
- [5.9] Wirsching, P. H., Stewart, D. A., Torng, T. Y., and Kung, C. J. (1991). ***Cost/Benefit-Based Inspections: The Inspection, Maintenance and Repair Process for Fixed Offshore Structures, Proceedings of the Marine Structural Inspection, Maintenance, and Monitoring Symposium.*** Arlington, Virginia.
- [5.10] Weber, P. F. (1984). ***Structural Surveys of Oil Tankers.*** The Institute of Marine Engineers, London, England.
- [5.11] Balczewski, J. T. (1990). ***Fatigue and Corrosion in VLCCs.*** Paper Presented At 12th Annual Industrial Liaison Program, Univ. of Cal. at Berkeley.
- [5.12] Exxon Corporation (1982). ***Large Oil Tanker Structural Survey Experience, A Position Paper by Exxon Corporation.*** Report to Tanker Structure Cooperative Forum.
- [5.13] Stambaugh, K. A. and Knecht, J. C. (1991). ***Corrosion Experience Data Requirements.*** Ship Structure Committee Report No. SSC-348.

---

## Marine Structural Integrity Programs

---

- [5.14] Purtell, T.W., Mielke, T.C., and Brusseau, J.P. (1988). *Marine Structural Casualty Study*, Report to the Marine Inspection Program Casualty Review Council, U.S. Coast Guard, Washington, D.C.
- [5.15] Ferguson, J. M. (1991). *Some Considerations Regarding Tank Inspection Priorities for Oil Tankers. Proceedings Marine Structural Inspection, Maintenance and Monitoring Symposium*, Arlington, Virginia.
- [5.16] Patofatto, G. (1991). *The Evolution of Inspection and Repair Procedures for Ship Structures. Proceedings Marine Structural Inspection, Maintenance and Monitoring Symposium*, Arlington, Virginia.
- [5.17] Witmer, D. (1990). *Tank Inspection Methods and Techniques*. Presentation to Committee on Marine Vessel Corrosion, National Association of Corrosion Engineers, NACE Technical Committee T-14B, Denver, Colorado.
- [5.18] Ternus, R. A. (1991). *Inspection and Structural Maintenance of Chevron's Tanker Fleet, Proceedings Marine Structural Inspection, Maintenance and Monitoring Symposium*, Arlington, Virginia.
- [5.19] Demsetz, L., Cepkauskas, M., and Holtzman, R. (1991). *Tank Inspection Developments*. Paper delivered at 17th Annual Industrial Liaison Program Meeting, Univ. of California at Berkeley.
- [5.20] DeBord, F. W. and Hennessy, B. (1990). *Development of a Generalized Onboard Response Monitoring System*. Ship Structure Committee Report No. SSC-349.
- [5.21] United States Coast Guard (1989). *Report of the Tanker Safety Study Group*, U. S. Dept. of Transportation, Washington, D.C.
- [5.22] Bea, R. G., Pollard, R. R., Schulte-Strathaus, and Baker, R. K. (1991). *Structural Maintenance of New and Existing Ships. Proceedings of the Marine Structural Inspection, Maintenance, and monitoring Symposium*, Arlington, Virginia.
- [5.23] Jennings, E., Grubbs, K. Zanis, C., and Raymond, L. (1991). *Inelastic Deformation of Plate Panels*, Ship Structure Committee Report No. SSC-364.

**Table 5. 1- Summary of Advantages and Disadvantages of Alternative Tank Inspection Methods**

ALTERNATIVE	ADVANTAGES	DISADVANTAGES
<b>Walking the bottom - Close-up inspection of accessible structure without climbing</b>	<ul style="list-style-type: none"> <li>• Allows close-up visual inspection by all parties</li> <li>• Allows detailed documentation</li> <li>• No set-up time required</li> <li>• Highly accessible for repairs</li> </ul>	<ul style="list-style-type: none"> <li>• Limited to the bottom</li> </ul>
<b>Binoculars with high-intensity lights</b>	<ul style="list-style-type: none"> <li>• Easy to conduct</li> <li>• Accepted by regulatory groups and classification societies (?)</li> </ul>	<ul style="list-style-type: none"> <li>• Not a reliable procedure</li> <li>• Cannot see close-up</li> </ul>
<b>Physical climbing without restraint</b>	<ul style="list-style-type: none"> <li>• Allows visual inspection of some details</li> </ul>	<ul style="list-style-type: none"> <li>• Safety is compromised</li> </ul>
<b>Physical climbing with fall safety devices</b>	<ul style="list-style-type: none"> <li>• Allows close-up inspections of side shell structure</li> <li>• Provides proven degree of safety</li> <li>• Minimal set-up time</li> </ul>	<ul style="list-style-type: none"> <li>• Physically demanding</li> <li>• Difficult to record findings</li> <li>• Underdeck structure not accessible</li> </ul>
<b>Staging</b>	<ul style="list-style-type: none"> <li>• Allows close-up inspection of all structure by all parties</li> <li>• Allows detailed documentation</li> <li>• Provides accessibility for repairs and follow-up inspection</li> </ul>	<ul style="list-style-type: none"> <li>• Cost is high</li> <li>• Set-up and break-down time is long</li> <li>• Risks of falling planks, etc.</li> </ul>
<b>Mechanical devices</b>	<ul style="list-style-type: none"> <li>• Allows close-up inspections</li> <li>• Allows detailed documentation</li> </ul>	<ul style="list-style-type: none"> <li>• Set-up, break-down time is long</li> <li>• Awkward to rig and handle equipment</li> <li>• Typically accommodate only one person at a time</li> <li>• Cost is high</li> </ul>
<b>Rafting</b>	<ul style="list-style-type: none"> <li>• Allows close-up inspection</li> <li>• Allows detailed documentation</li> <li>• Eliminates risk of falling</li> </ul>	<ul style="list-style-type: none"> <li>• Underdeck structure basically inaccessible due to depth of webs</li> <li>• Time consuming</li> </ul>

**Table 5.1 - Summary of Advantages and Disadvantages of Alternative Tank Inspection Methods**

<b>ALTERNATIVE</b>	<b>ADVANTAGES</b>	<b>DISADVANTAGES</b>
<b>Divers</b>	<ul style="list-style-type: none"> <li>• Allows close-up inspections</li> <li>• Good documentation (video, photographs, etc.)</li> <li>• Can perform NDT underwater (accessibility)</li> </ul>	<ul style="list-style-type: none"> <li>• Requires divers with good knowledge of ship's structure</li> <li>• Time consuming</li> <li>• High cost</li> </ul>
<b>Remote Operated Vehicles (ROVs)</b>	<ul style="list-style-type: none"> <li>• Allows close up inspections</li> <li>• Can perform video and NDT work</li> <li>• All parties can watch on monitor or view video recordings</li> </ul>	<ul style="list-style-type: none"> <li>• High reliability</li> <li>• Easy to become disoriented</li> <li>• Time consuming</li> <li>• Field of vision limited</li> <li>• Requires topsides support staff</li> <li>• High cost</li> </ul>
<b>ROVs with diver support</b>	<ul style="list-style-type: none"> <li>• Refer to divers and ROVs</li> </ul>	<ul style="list-style-type: none"> <li>• Refer to divers and ROVs</li> </ul>
<b>Periscopes and borescopes</b>	<ul style="list-style-type: none"> <li>• Close-up inspection via deck openings</li> </ul>	<ul style="list-style-type: none"> <li>• Developmental</li> </ul>
<b>Permanent in-tank catwalks, walkways, ladders, etc.</b>	<ul style="list-style-type: none"> <li>• Allows close-up inspections by ball parties</li> <li>• Allows good documentation</li> <li>• Easy access</li> </ul>	<ul style="list-style-type: none"> <li>• Cost is high</li> <li>• Additional structure which must be maintained (corrosion protection, cleaned prior to use)</li> </ul>

**Table 5.2 - Guide to Non-Destructive Testing of Welds**

INSPECTION METHOD	EQUIPMENT	TO DETECT	ADVANTAGE	DISADVANT.	COMMENTS
VISUAL	Magnifying glass Weld-size gauge Pocket rule Straight edge Workmanship standards Pit gauge	Surface Flaws Warpage Under-welding Poor profile Improper fitup Misalignment	Low cost Apply while work in prog. Indication of incorrect procedures	Surface defects only No permanent record	Primary means of inspection
RADIO-GRAPHIC	Commercial X-ray or gamma units Film processing unit Fluoroscopic viewing equip.	Interior Macroscopic flaws	Permanent Record	Skill needed to achieve good results Safety precautions Not suitable for fillet welds Costly	Required by many codes and specs. Useful in qualifying welders
MAGNETIC-PARTICLE	Commercial MPI units Powers, dry, wet, fluorescent for UV light	Surface discontinuities	Simpler than radiographic Permits controlled sensitivity Relatively low cost	Applicable to ferromagnetic materials Requires skill in interpretations Difficult to use on rough surf.	Elongated defects parallel to magnetic may not give pattern
LIQUID PENETRANT	Commercial kits containing fluorescent or dye penetrants Source of UV light	Surface cracks Excellent for locating leaks in weldments	Applicable to magnetic, nonmagnetic materials Easy to use Low Cost	Only surface defects detect Cannot be used on hot assemblies	Irrelevant surface conditions may give misleading indications
ULTRA-SONIC	Special commercial equipment of the pulse-echo or transmission type Standard reference patterns for interpretation of RF or video patterns	Surface and subsurface flaws and laminations	Very sensitive Permits probing of joints	Requires high degree of skill in interpreting pulse echo patterns Permanent record not readily obtained	Pulse-echo equipment is highly developed Transmission-type equipment simplified pattern interpretation

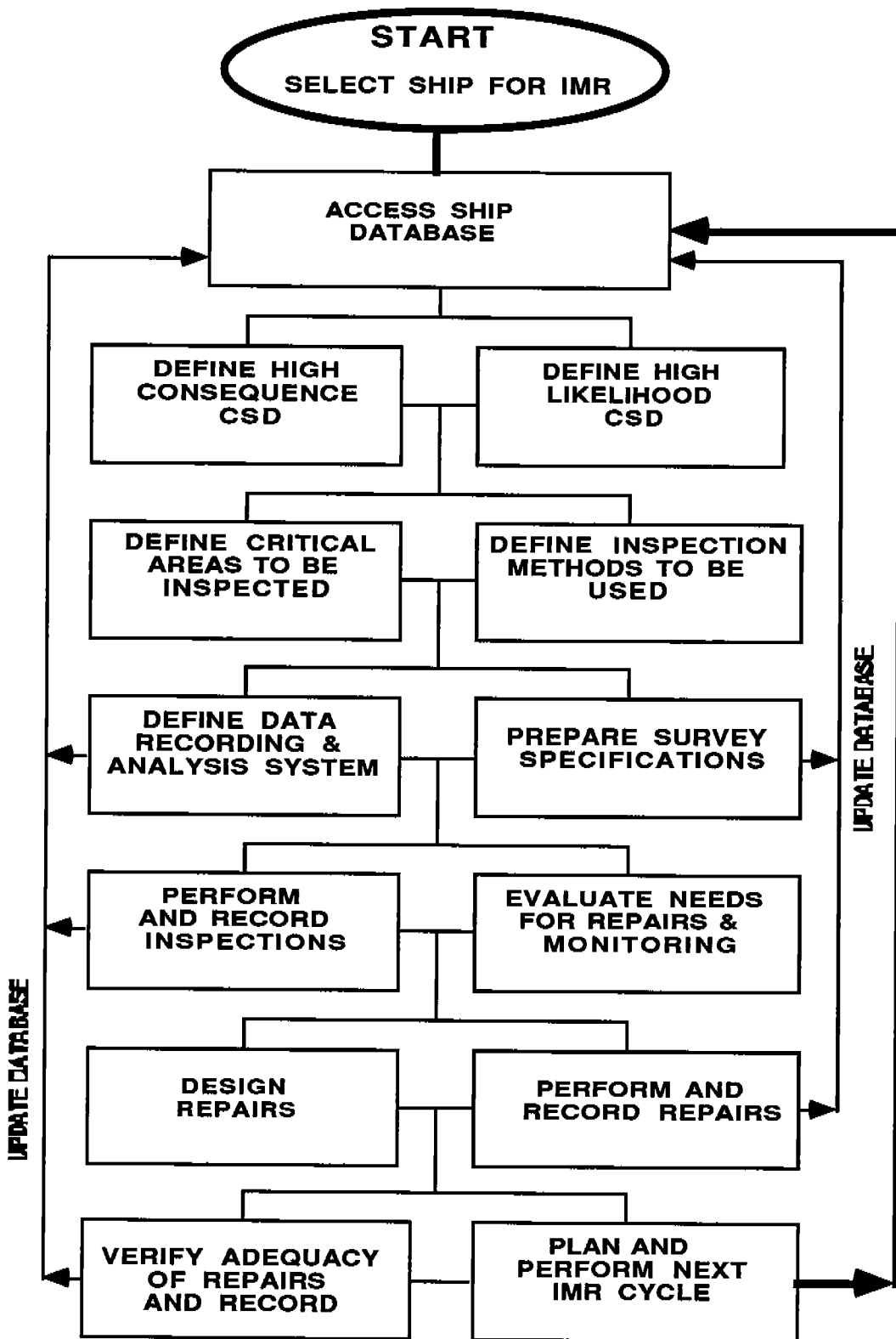
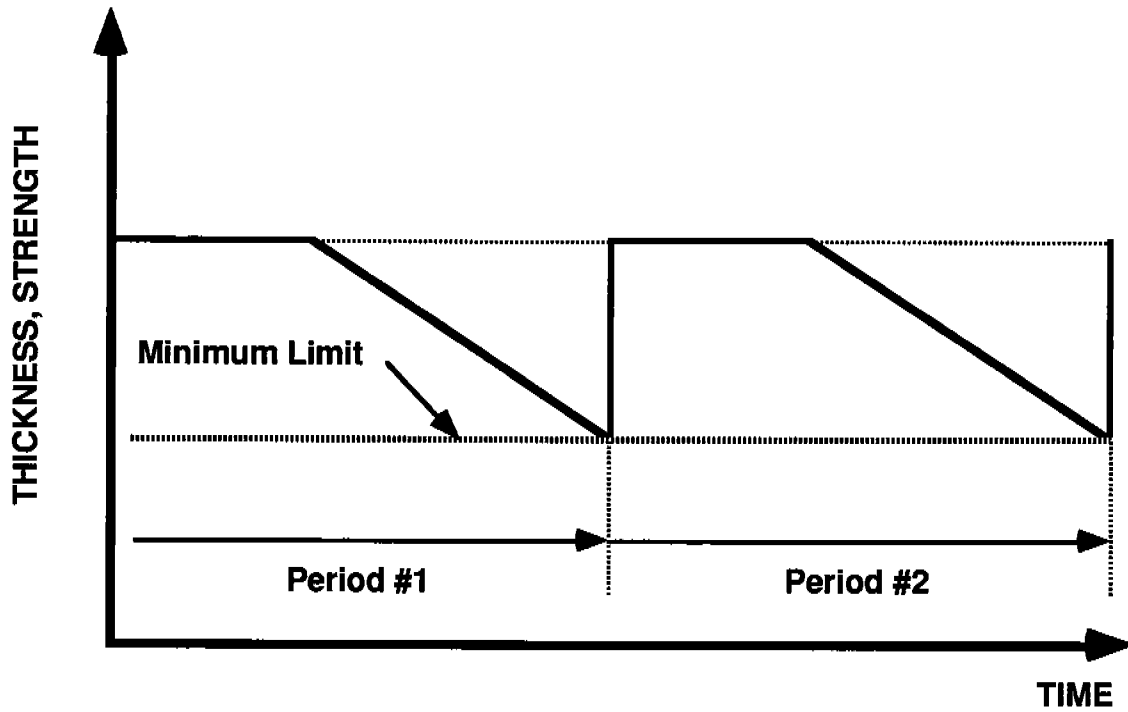
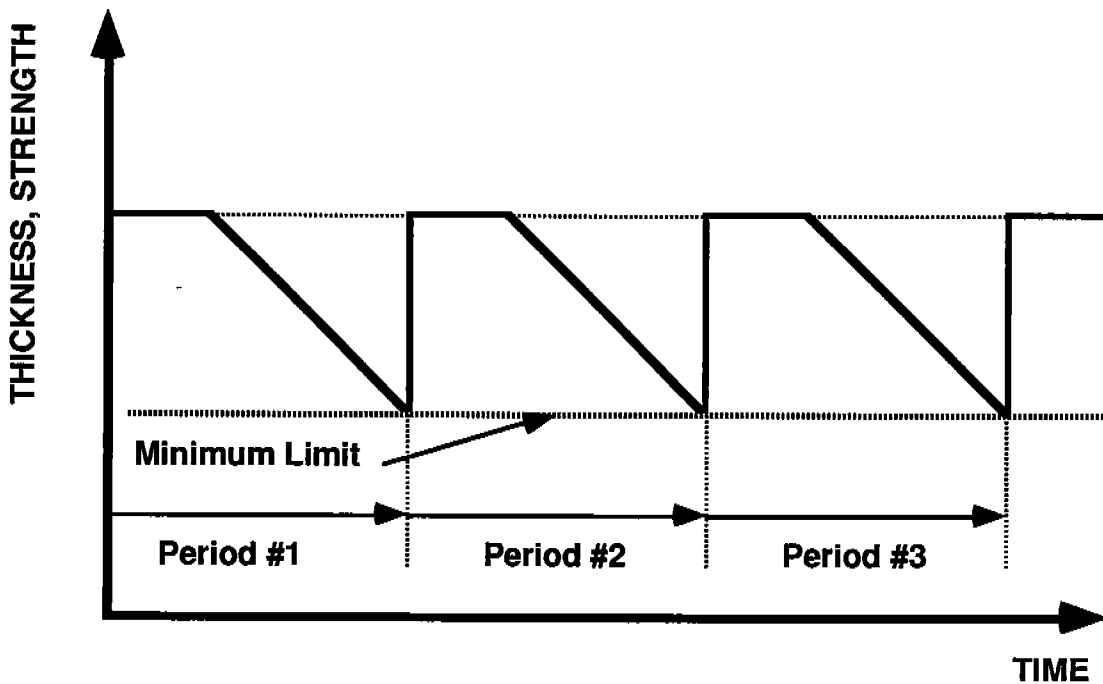


Figure 5.1 - Technical Basis for Preparation of IMR Strategies





**DURABLE DESIGN & CONSTRUCTION**



**NON DURABLE DESIGN & CONSTRUCTION**

**Figure 5.2 - Effects of Durable and Non-Durable Designs on IMR Cycles**

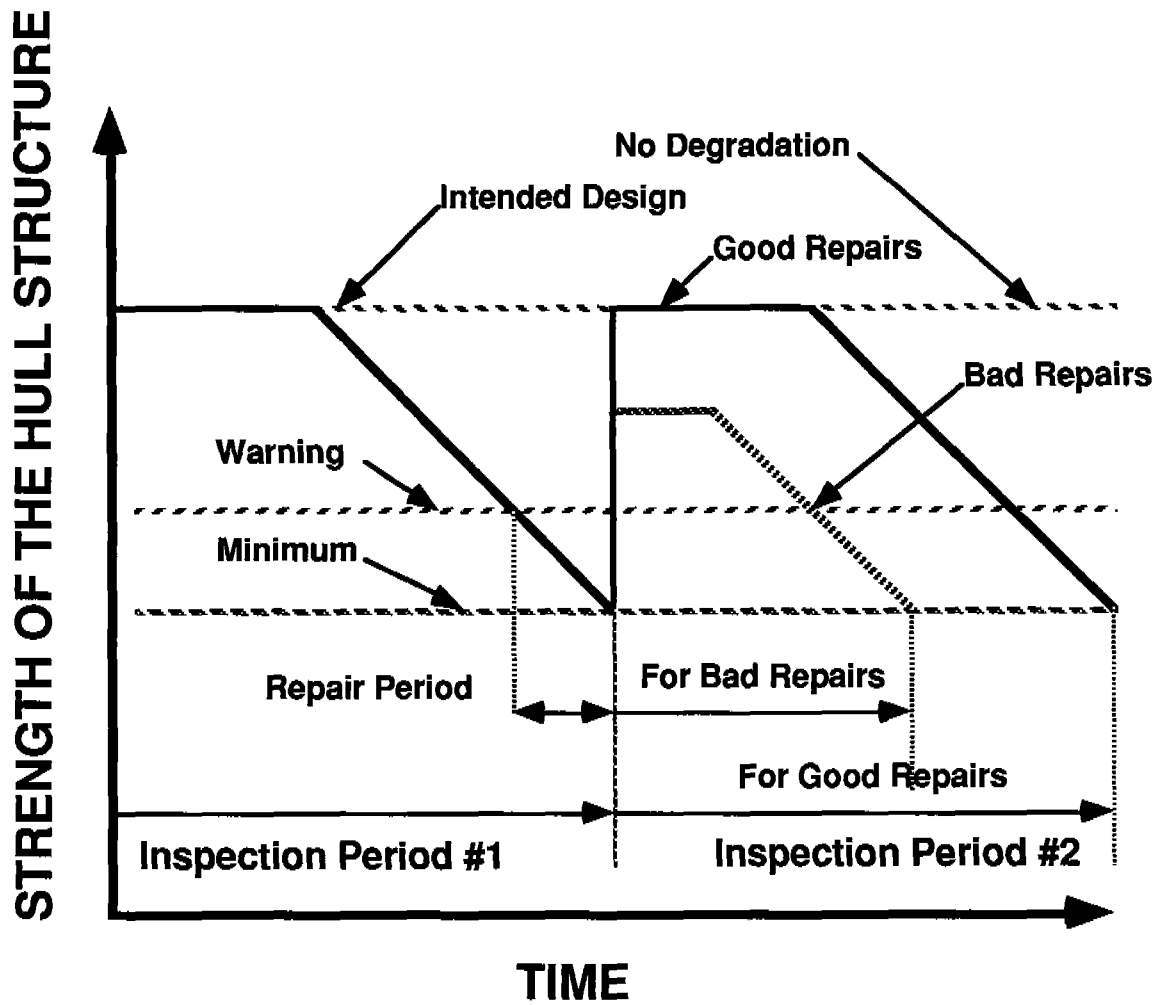
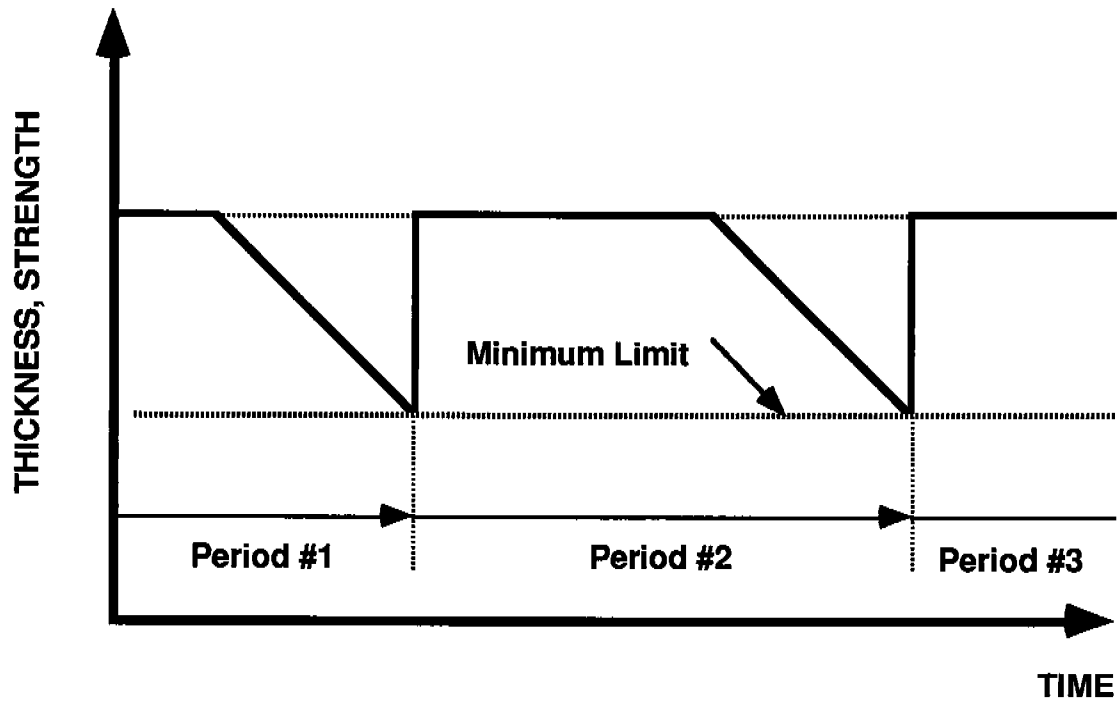
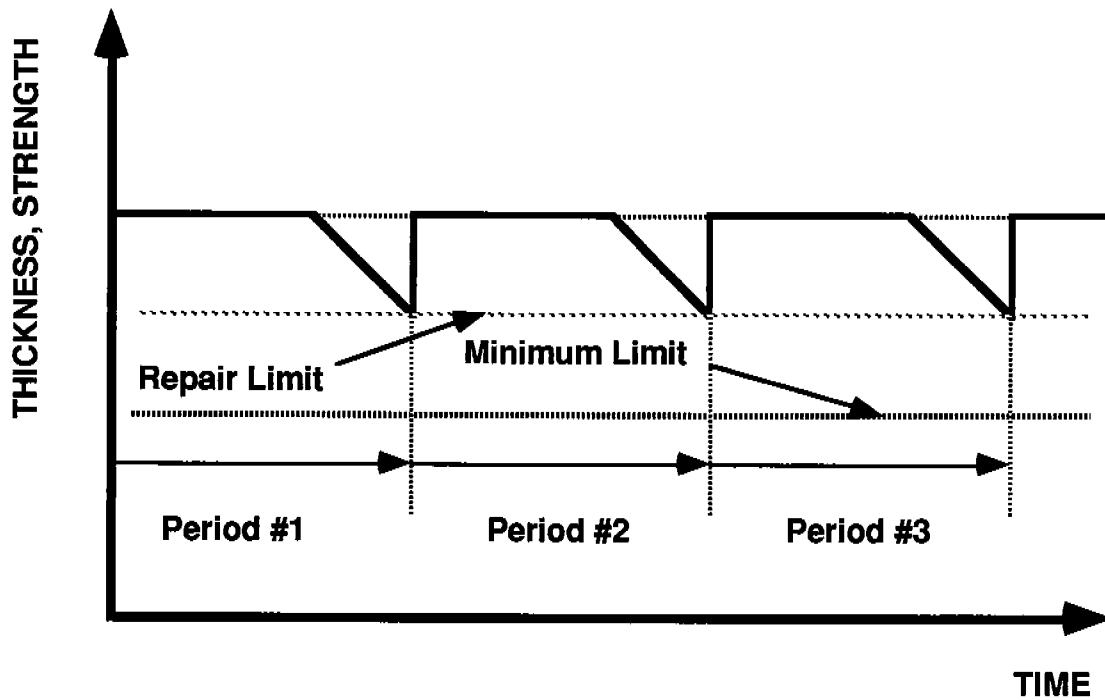


Figure 5.3 - Effects of Early Warnings, Good and Bad Repairs on IMR Cycles

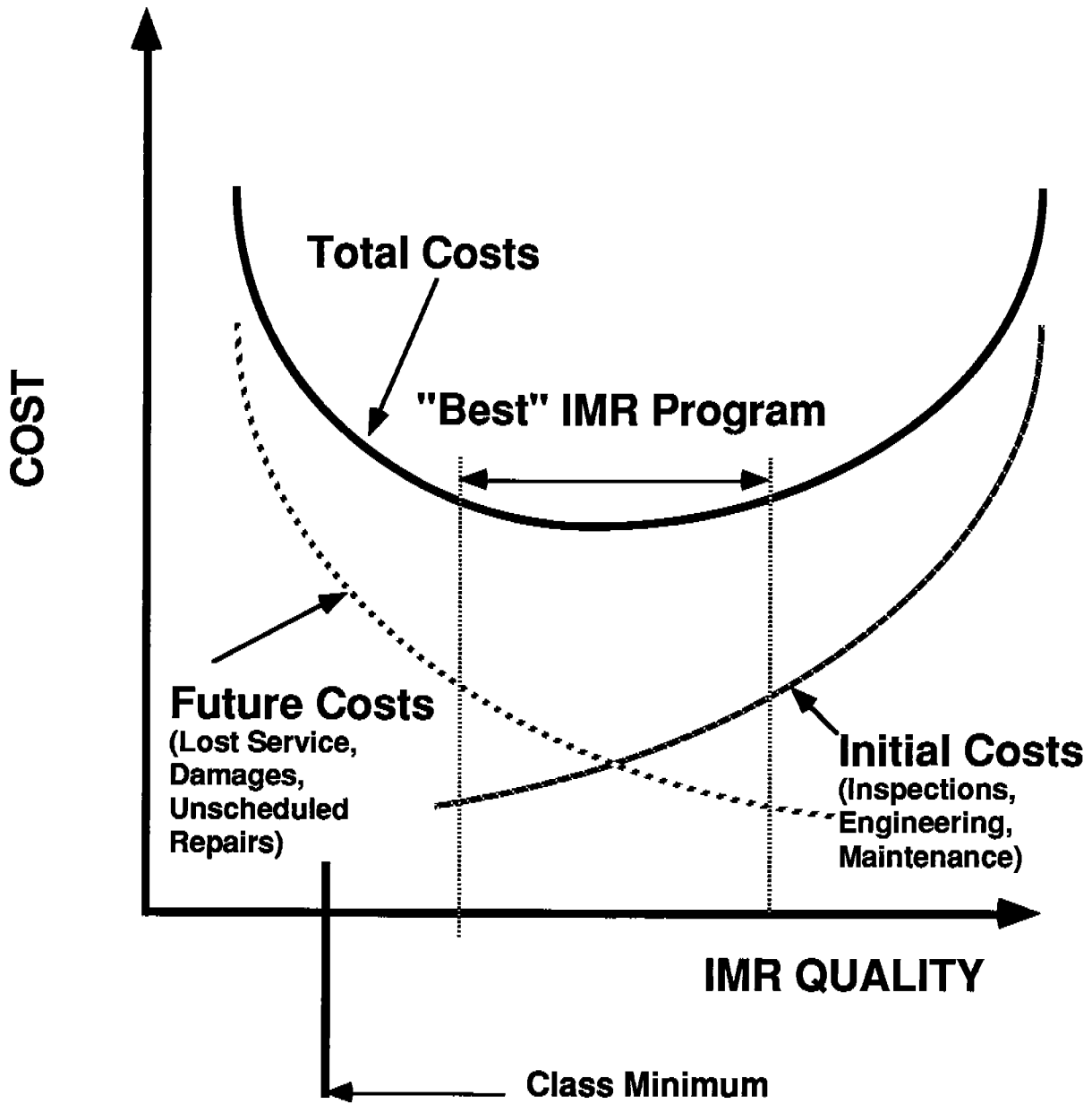


INSPECTIONS & REPAIRS ON DEMAND



PROGRAMMED INSPECTIONS & REPAIRS

Figure 5.4 - Effects of Demand Based and Programmed IMR on Timing of IMR Cycles



**Figure 5.5 - Cost Based Evaluation of Desirable IMR Quality**

## INFORMATION SYSTEMS

### **Introduction**

---

**The objective of this chapter is to define the basic components of an information system that can be used as a basis for developing MSIP consistent with the needs of all interested parties.**

One of the major differences noted in comparing present ASIP and MSIP was the degree of development of industry information systems. ASIP has highly developed and utilized industry-wide information systems. Much attention is given to the intensity and integrity of communications between the principal organizational components of the commercial and military ASIP industries.

MSIP for crude carriers have no such industry-wide information systems. Present MSIP information systems range from paper and pencil based file systems to groups such as the American Petroleum Institute and the Tanker Structure Cooperative Forum. All industry functions including owner/operators, regulators, builders and repairers, and classification agencies are presently information interconnected through a complex system of informal and formal channels.

Present MSIP information systems are not highly developed. Design and construction plans for some ships are difficult to obtain (in some cases, they no longer exist). In many cases, survey data and reports are difficult if not impossible to retrieve. Maintenance and repair information can consist of a few rough sketches in a repair superintendent's notebook and shipyard invoices collected in a repair file. In the main, the present MSIP information system resides in the brains and file systems of a few key individuals in each of the component organizations that comprise this industry.

The USCG and some owner/operator organizations have pioneered development of what can be evolved into industry-wide computer based information systems [6.1-6.7]. At the present time, these systems are in their very early stages of development by individual groups and owner/operator organizations.

The present industry MSIP information system needs to be organized and made more efficient and effective. Data collection is expensive, but data

---

## **Marine Structural Integrity Programs**

---

archiving, analysis, retrieval, and communications are more expensive. Perhaps, most expensive are the lessons learned, that are not properly understood and must be relearned.

Modern computer and telecommunications based information systems provide a strong basis to help improve the efficiency and effectiveness of MSIP.

Over three decades of ASIP information systems development experience provides an excellent guide for advanced MSIP systems. As a first step in development of an advanced MSIP system, the present FAA based ASIP information system should be carefully evaluated for its applications to an advanced MSIP information system.

**The fundamental objective of development of an advanced MSIP information system is to provide all segments of this industry with a consistent and reliable basis to evaluate the quality of a particular MSIP. The information can be used to improve design, construction, and IMR operations throughout the life-cycle of a particular ship.**

The system is also intended to provide a basis for quality control and quality assurance in all of the life-cycle aspects of MSIP. In this context, the information system can serve as an "early warning" system, providing alerts for unanticipated developments, and allowing time for prudent corrections or mitigations of the developments.

Given the need to improve the performance and durability characteristics of tanker hull structures, then MSIP information systems can help improve the efficiency and effectiveness of MSIP. In the long term, these improvements can lead to reductions in total MSIP costs.

---

## **Technical Aspects**

---

### **Major Components**

The major components of an MSIP information system are (Table 6.1):

- **MSIP plans,**
- **Design information,**
- **Construction information,**
- **Operations information,**

- **Maintenance and repair information, and**
- **Inspection and monitoring data.**

This information is intended to track the hull structure of a particular vessel throughout its life-cycle.

**MSIP Plans** - MSIP plans are the premises for the life-cycle operations of a particular vessel. These include plans for design (configuration, sizing, classification), construction (materials, fabrication, assembly, commissioning), operations, and IMR.

**Design Information** - The design information is intended to summarize the primary aspects that pertain to the configuration and sizing of the hull structure system including such items as design criteria, loading analyses, materials and fabrication procedures and specifications, stress, durability, and damage tolerance analyses, element and component testing programs (to verify design assumptions), the classification program, and most importantly the design documentation including design drawings and analytical models.

**Construction Information** - The construction information is intended to document the MSIP related developments that occur during the construction phase including the materials and fabrication specifications that were used, the quality assurance and control reports, the commissioning inspection reports, design variances, and the as-built drawings.

**Operations Information** - During the long-term operations phase of a ship, there are many important developments that pertain to MSIP including the voyages, cargos, ballasting and loadings, cleaning, IGS system operations, results from in-service inspections and monitoring (structural instrumentation), and accidents (e.g. collisions, groundings, improper cargo unloading).

**Maintenance and Repair Information** - Maintenance information can consist of results from scheduled and unscheduled, temporary and permanent repairs that are made to the ship hull structure, maintenance performed to preserve corrosion protection (coatings, cathodic protection), and cleaning operations intended to facilitate inspections and maintenance.

**Inspection and Monitoring Information** - Results from in-service and scheduled inspections and surveys including visual, photographic, structural performance records (from shipboard instrumentation systems) and nondestructive testing (NDT) data. This is a particularly data intensive portion of the system since it must archive many thousands of corrosion, cracking, and structural monitoring data points.

### **Major Functions**

The MSIP information system should provide for three major functions:

- 1) Archive tabular and graphic life-cycle MSIP data and information,**
- 2) Provide for and expedite the analysis, evaluation, and communication of the data and information throughout the MSIP life-cycle, and**
- 3) Provide for and expedite development and conduct of next-cycle IMR programs.**

Because of the data intensive nature of most of this information, computer database and analysis systems are particularly attractive. The computer database systems can incorporate both tabular and graphical capabilities to archive and portray data. The computer system can provide for standard analysis of the information to assist in evaluations and communications of MSIP developments.

The interactive capabilities of the computer and MSIP personnel systems can be used to expedite inspection, maintenance and repair plans and operations.

Development of components of a comprehensive MSIP information system [6.1-6.7] have shown that the information system will have important ramifications on how records are taken and communicated to the computer. The problem of "geography" within the ship hull structure is a prime example. At the present time, there is no standard way to describe the location of a particular survey result; there is no standard coordinate system. The precise spatial location of inspection results within a hull structure is difficult during the conduct of the inspections. Development of graphical data reporting forms can greatly facilitate gathering such information.

### **Current MSIP Information System Developments**

**Corrosion Databases** - Two recent investigations have addressed development of corrosion databases [6.7, 6.8, 6.13]. These studies have identified the primary information that should be incorporated, how the data can be gathered (instrumentation and survey procedures), provided a database framework for data input, and provided a database management system to facilitate analyses and evaluations of the information. The reader should consult references 6.7, 6.8 and 6.13 for additional details on development of corrosion databases.



A particularly difficult part of the development of the corrosion databases is the problem associated with the very large volumes of data that must be recorded and input to the computer. A single gauging survey can result in 8,000 to 10,000 readings. Paper based recording procedures are very labor intensive and can result in long lag-times between when the data is gathered and evaluated. This can result in substantial inefficiencies during the maintenance and repair operations. Portable computer instrument recording and digital voice translation and recording systems need to be further developed to improve the efficiency and accuracy of this operation [6.9].

Surveys are typically conducted every three to five years, as dictated by classification societies, or the operators own internal maintenance philosophy (which ever is sooner). The reports can range in detail from simple belt girth gaging, to full surveys of major details in all tanks. The number of gaugings might range from a few hundred to several thousand. These are then compiled in binders, typically ordered by tank or detail type.

The corrosion rate is determined by the environment that the element is exposed to. What is important is more than just the relative amount of salt present in the water. The composition of the corrosive is not necessarily the most important factor in determining the corrosion rate. For ballast tanks one might say that over a large sample of vessels in the same trade the composition of the ballast is the same. Even in this case, one can expect to see vastly different corrosion rates in ships which have heated cargo and those without. There are in fact innumerable differences in the conditions in which corrosion takes place, some crucial, some less so.

The amount of corrosion data on even a single ship makes the development of a data base a large bookkeeping problem; the sort of problem that is best suited to a database management system. If the data is organized in a rational fashion, analysis can be performed by simple search and average routines. Once the relevant data is input then, work can begin on an analysis. This is where the difficulty in this sort of work lies. It is vital in the beginning the database is constructed in such a way that all the important data is in fact included, and included in such a manner that it lends itself to analysis.

The corrosion related factors can be organized into three main types: Ship specific data, Tank specific data, and Incident specific data.

**Ship specific data** - data which are assumed to apply to all gaugings in all tanks for all surveys of a single ship. They include: ship size, date of build, cargo type (crude or product), double side, double bottom, class society, trade route (it is true that this may change over the life of the ship), and the units the surveys are taken in.

**Tank specific data** - including tank type, time in ballast (for ballast tanks), time in cargo (for cargo tanks), corrosion protection system,

fresh or salt water ballast, clean or dirty ballast, sulphur, water, and wax content of cargo, presence of heated cargo, IGS gas quality (% sulphur), and method and amount of tank washing.

**Incident data** - an incident of corrosion is defined as a location where a gauging was taken. Thus every gauging represents a corrosion incident, and every gauging from the survey is included in the data base. The incident data includes: ship age at survey, the type of corrosion, the type of detail the corrosion is gauged at, and some relative location in the tank of the gauging.

The data for the corrosion databases comes, for the most part, from the gauging portions of survey reports. These reports are intended to reflect the current condition of the structure in the tank. The reports are often not intended to allow one to understand how the condition of the structure is changing with time. The owner/operator may not be interested in understanding how corrosion rate is changing, having more than enough to worry about in simply maintaining the vessel. Because of this, no consistent, coherent effort has been made to insure that the data, the gaging portions of the survey reports, are collected to further this effort. Often gaugings are not taken at the same location in each survey, giving no time continuity to the data making it difficult to understand then how the corrosion will vary through time.

As well, data for localized corrosion is not well defined. Different firms, depending upon their maintenance philosophies regarding localized corrosion, collect data on the various forms of corrosion (pitting, grooving) in different manners, whether it is simply counting the number of pits in a tank, or identifying one gauging as taken in a pit. No industry standard method of evaluating the corrosion damage by localized is used. This has made the effort to analyze localized corrosion in the same manner as general corrosion difficult, if not impossible. An alternate method to deal with localized corrosion must be developed.

**Fatigue Cracking Databases** - Two recent studies have addressed development of fatigue cracking databases [6.5, 6.6]. These studies have identified the primary information that should be gathered, how the data can be gathered (instrumentation and survey procedures), provided a database framework for data input, and provided a database management system to facilitate analyses and evaluations of the information.

Development of the database described in reference [6.6] identified several important problems and constraints:

- There is not a general spatial location identification coordinate system for all the different classes of tankers.

- Within the scope of this database, the reoccurrence of a crack cannot be determined. Ineffective repairs cannot be documented. This is a major drawback for a repairs database.
- The type of crack and the location within a detail have to be described by a set of key words. Many of the geometric details of the crack can not be captured by this system.

**Repairs Databases** - One recent study has addressed the development of a repairs data base [6.12]. The database which is still being developed includes information on cracking repairs, crack monitoring, steel renewals (due to corrosion and cracking damage), coating repairs and renewals, and cathodic protection renewals.

The fundamental problem encountered in the development of this database was the lack of an organized and retrievable set of data and information that could be incorporated into the database. While in some cases portions of the data exists, the manpower and time required to retrieve, copy, and integrate the data into a database is prohibitive.

Tanker operators in general are not making full use of computers as tools in tracking repair expenditures and maintenance documentation. Generally, there is the lack of organization in engineering files for retrieving information quickly on steel and coating repairs. Much information including visual and ultrasonic surveys reports is missing or extremely difficult to retrieve due to poor record archiving.

Many ship owners and operators have very informal systems for tracking the details of maintenance of a given ship. Documentation ranges from a coherent history of reasonably detailed shipyard repair reports on crack repairs, steel renewals, and coatings and anodes maintenance to scattered shipyard invoices that define gross tonnages and areas. The documentation varies widely as a function of the diligence of the owner and operator, and as a function of the ship's life. Maintenance documentation developed during the first five years of a ship's operation frequently cannot be retrieved by the fifteenth year.

Documentation of crack repairs frequently cannot be tracked from one repair to another repair cycle. Thus, it becomes impossible to evaluate the effectiveness of given types of repairs. The problem of documentation of crack repairs is further complicated by corrosion. In many cases, if corrosion is extensive, cracking will not be noted; it will only be noted that the detail or section needs to be replaced. In several cases, we have found that cracks that were to be repaired in a certain manner were not repaired at all or were repaired in a manner different from that specified in the repair report.

---

## **Marine Structural Integrity Programs**

---

Similar problems exist with regard to maintenance of coatings and anodes. Details of locations and the coating break downs and the procedures used to repair the break downs are frequently not documented. Coating repairs will be noted in terms of total area, the coating used in the repair, and the cost per unit area. This does not make it possible to track the effectiveness of coating repairs nor the basic durability characteristics of the original coatings. Similar statements apply to anodes.

**MSIP Databases** - The basis for development of a comprehensive MSIP information system has been developed by Chevron Shipping Co.; the system is identified as CATSIR (Computer Aided Tanker Structure Inspection and Repair) [6.3, 6.4]. This system has been under development for about five years. It is founded on a similar system developed for offshore platforms (CAIRS, Computer Aided Inspection and Repair System). The CAIRS system has been under development for almost 10-years [6.].

The primary 16 components or data modules that comprise the CATSIR (3.0) system are summarized in Table 6.2. Additional components of this system are being developed as a part of the industry sponsored research project on Structural Maintenance for New and Existing Ships [6.12].

The CATSIR system incorporates both tabular and graphical (Computer Aided Design, CAD) capabilities [6.3, 6.4]. The system also incorporates basic analysis and data management capabilities. It is designed to be interactive. The system is designed to incorporate survey, inspection, operation, and maintenance data in the field. Electronic data transmission facilitates maintenance engineering evaluations and assistance.

---

## **Organizational Aspects**

---

Highly developed and utilized MSIP information systems are a very important component of an advanced MSIP. For such information systems to be a reality there must be an industry wide commitment to development, implementation, and continued utilization of such systems. This means that the MSIP information system must inter-connect the four principal industry organizational components (Owner/Operator, Builder/Repair Yard, Regulatory, and Classification).

Fundamental components on which to found an advanced MSIP information system have been developed by the USCG [6.1, 6.2], and several tanker owner/operator organizations [6.3-6.5]. What is needed is to integrate and further develop these components into an MSIP information database system that can be accessed and utilized by the industry. The

framework provided by the FAA ASIP information system could be used as a model for such integration.

---

## Summary

---

This chapter has defined the basic components of an information system that can be used as a basis for developing advanced MSIP. Hopefully, given the organizational framework that has been suggested, the developments can be consistent with the needs of all interested parties.

Several major components for such an information system have been and are being developed. The FAA has developed a parallel information system for ASIP. Both of these developments have been discussed here.

It is timely for the industry to examine the technical and organizational aspects associated with development of an industry-wide MSIP information system. The basic building blocks for such a system exist. They need to be further developed to improve data gathering, input, analysis, evaluation, and implementation in the form of more effective and efficient MSIP activities.

---

## References

---

- [6.1] U. S. Coast Guard (1989). *Marine Safety Information System, Report of the Tanker Safety Study Group*. U. S. Dept. of Transportation.
- [6.2] Morani, W. J., Purtell, T., and Cojeen, P. (1988). *Human Factors Related Marine Casualties*, Ad-Hoc Human Factors Work Group, Report-167732/2, G-MVI-2., U. S. Coast Guard (1990).
- [6.3] Ternus, R. A. (1991). *Inspection and Structural Maintenance of Chevron's Tanker Fleet, Proceedings Marine Structural Inspection, Maintenance and Monitoring Symposium*, Arlington, Virginia.
- [6.4] Tikka, K., and Donnelly, J. W. (1991). *CATSIR Computer Aided Tanker Structures Inspection and Repair Planning, Proceedings Marine Structural Inspection, Maintenance and Monitoring Symposium*, Arlington, Virginia.
- [6.5] Letcher, J., Shook, D., and Sucharski, D. (1991). *A Graphical Database for Hull Fracture Reports, Proceedings Marine Structural Inspection, Maintenance and Monitoring Symposium*, Arlington, Virginia.

- [6.6] Schulte-Strathaus, R. (1991). ***Fatigue Database Development and Analysis***. Project Report No. SMP-1-1, Structural Maintenance for New and Existing Ships, Dept. of Naval Arch. & Offshore Eng., Univ. of Cal., Berkeley.
- [6.7] Pollard, Rob Roy (1991). ***Evaluation of Corrosion Damage in Crude & Product Carriers***. Project Report No. SMP-2-1, Structural Maintenance for New and Existing Ships, Dept. of Naval Arch. & Offshore Eng., Univ. of Cal., Berkeley.
- [6.8] Stambaugh, K. A., and Knecht, J. C. (1991). ***Corrosion Experience Data Requirements***. Ship Structure Committee Report No. SSC-348.
- [6.9] Demsetz, L., Cepkauskas, M., and Holtzman, R. (1991). ***Tank Inspection Developments***. Paper delivered at 17th Annual Industrial Liaison Program Meeting, Univ. of California at Berkeley.
- [6.10] Stambaugh, A and Wood, W. A. (1987). ***Part 1 - Ship Fracture Mechanisms Investigation***. Ship Structure Committee Report No. SSC-337.
- [6.11] Stambaugh, A and Wood, W. A. (1987). ***Part 2 - Ship Fracture Mechanisms - A Non-Expert's Guide for Inspecting and determining the Causes of Significant Ship Fractures***. Ship Structure Committee Report No. SSC-337.
- [6.12] Bea, R. G., Pollard, R. R., Schulte-Strathaus, and Baker, R. K. (1991). ***Structural Maintenance of New and Existing Ships. Proceedings of the Marine Structural Inspection, Maintenance, and monitoring Symposium***, Arlington, Virginia.
- [6.13] Tanker Structure Co-operative Forum (1986). ***Guidance Manual for the Inspection and Condition Assessment of Tanker Structures***. International Chamber of Shipping Oil Companies International Marine Forum, Witherby & Co. Ltd., London, 1986.

**Table 6.1 - Summary of Vessel Tabular and Graphical Database Components**

<p><b>MSIP PLANS</b></p> <p>Design Construction Operations Inspections, Monitoring, Maintenance, Repairs</p>
<p><b>DESIGN INFORMATION</b></p> <p>Design Criteria Rules Materials &amp; Fabrication Loading Analyses Stress Analyses Damage Tolerance Analyses Durability Analyses Design Development Test Program Monitoring Program Development Classification Program Design Documentation Design Drawings</p>
<p><b>CONSTRUCTION INFORMATION</b></p> <p>Specifications Builder Quality Assurance &amp; Control Procedures Quality Assurance &amp; Control Reports Inspections Design Variances As-built Drawings</p>
<p><b>OPERATIONS INFORMATION</b></p> <p>Voyages Cargos Ballasting Procedures Cargo Loading and Unloading Procedures Cleaning Monitoring Results Accidents</p>
<p><b>MAINTENANCE INFORMATION</b></p> <p>Cleaning Coating Repairs Cracking Repairs Steel Renewals</p>
<p><b>INSPECTION AND MONITORING DATA</b></p> <p>Corrosion Survey Reports Cracking Survey Reports Monitoring Program Reports</p>
<p><b>REPAIR INFORMATION</b></p> <p>Coating Repairs and Maintenance Cathodic Protection Repairs and Maintenance Fracture Repairs Steel Renewals</p>

**Table 6.2 - Summary of CATSIR Database Components**

<p><b>MODULE 1 - VESSEL INFORMATION</b></p> <p>Vessel ID  Units  Vessel Name  Vessel Class Name  Owner  Previous Owners  Classification Society  Registry  Delivery Date  Builder  Official # / Hull#  Major Conversion Type  Major Conversion Date  LOA  LBP  Depth  Beam  Draft  Summer LDWT  Clean Product  Black Oil  SBT  IGS  COW system  Heat Coiled  Double Bottom  Double Side  Propulsion System  Screw Description  Service Speed (loaded)  Service Speed (ballast)  Bow Thrusters  Bilge Keels  Comments</p>
<p><b>MODULE 2 - DRAWING LIBRARY</b></p> <p>Vessel ID  Tank ID  Drawing Name  As Built Drawing  Conversions/Modifications Drawing  Comment</p>
<p><b>MODULE 3 - TECHNICAL INFORMATION</b></p> <p>General comments and observations  Key Words  Person Entering Information</p>
<p><b>MODULE 4 - SURVEY/OVERHAUL LOG</b></p> <p>Vessel ID  Survey Start and End Dates  Event ID  Overhaul Location  Inspection Company  Names of inspectors and Technicians  UT and NDT equipment  Comments</p>



**Table 6.2 - Summary of CATSIR Database Components  
(continued)**

<b>MODULE 5 - GAUGING INFORMATION</b> Vessel ID Drawing ID Event ID Member ID Steel Type Location Reading ID Original Thickness Current Thickness Units Lost Allowable % Wastage % Wastage Photo ID Comments
<b>MODULE 6 - PHOTO LOG</b> Vessel ID Tank ID Survey/Overhaul Date Roll No. Frame No. Caption
<b>MODULE 7 - STEEL RENEWAL</b> Vessel ID Drawing Name Event ID Revision #/Date Renewal Type Dimensions Steel Grade New/Renew Weight
<b>MODULE 8 - CARGO SPECS LIBRARY</b> Cargo Type Specific Gravity Wax Content Sulphur Content Water Content Comments
<b>MODULE 9 - TANK INFORMATION</b> Vessel ID Tank ID Usual Service ID Length Beam Depth Capacity From-To Frame Frame Spacing Bottom Long Spacing Bottom Long Type ID Side Long Spacing Deck Long Spacing Deck Long Type ID COW System Steam Coils IGS

**Table 6.2 - Summary of CATSIR Database Components  
(continued)**

---

**MODULE 10 - TANK VOYAGE HISTORY**

Vessel ID  
Tank ID  
Route  
Load Port  
Discharge Port  
Cargo Type  
Cargo Loading Date  
Cargo Discharge Date  
% Full Cargo Level  
Cargo Heating  
Temperature  
Ballast Date  
Ballast Origin  
% Full Ballast  
COW Date  
COW Duration  
COW Temperature  
COW Pressure  
Wash Date  
Wash Type  
Wash Duration  
Wash Temperature  
Wash Pressure  
Mucked Dated  
# Buckets Mucked  
% Scale  
Comments

**MODULE 11 - FRACTURES**

Vessel ID  
Tank ID  
Drawing Name  
Category  
Member Name  
Member Type  
Frame No.  
Date  
Length, USCG Class  
Date Repaired  
Repair Method  
Steel Type  
Cause/s  
Photo ID  
Comments

**MODULE 12 - PITS**

Vessel ID  
Tank ID  
Drawing Name  
Survey Date  
Cell Coordinate  
# Pits - Range 1, Range 2, Range 3, Range 4  
Comments

**Table 6.2 - Summary of CATSIR Database Components  
(continued)**

<b>MODULE 13 - PIPING SYSTEMS</b> Vessel ID Drawing Name Item Length Material Date Installed Diameter Inspections Repairs System ID# Degrees Rotated Date Rotated Schedule/Wall Thickness Comments
<b>MODULE 14 - ANODES</b> Vessel ID Tank ID Date Checked Drawing Name Location Length Width Thickness Weight Manufacturer Lot # Chemical Specification Attachment Method Date installed % Wastage Condition Comments
<b>MODULE 15 - COATING REPAIRS</b> Vessel ID Drawing Name Event Date Revision #/Date Coating Manufacturer Coating Lot # Relative Humidity Temperature Surface Preparation Method Date/Time of Primer Type Primer Date/Time of First Coat DFT of First Coat Stripe Coat Date/Time of Second Coat DFT of Second Coat Total of Coating Area Comments
<b>MODULE 16 - ROUTE LIBRARY</b> Route Name Description Comments

***This Page Intentionally Left Blank***

## EVALUATIONS OF ALTERNATIVES

### Introduction

---

**The objective of this chapter is to describe how to evaluate the cost effectiveness of various structural design strategies, including tradeoffs with such design issues as material selection, redundancy, and reserve strength.**

A ship owner has two primary concerns with regard to the hull structure. The first concern is with the load capacity of the structure (Fig. 7.1). The ship should not break apart during severe storms and loadings encountered during the intended life of the ship.

The second concern is with the durability of the hull structure. Durability is the degree of resistance of the hull structure to degradation in capacity with time. Such degradation is due principally to the combined effects of corrosion and fatigue. The ship owner does not want a hull structure whose strength will degrade rapidly or unexpectedly with time.

The desirable initial capacity of the ship hull structure and the durability of the structure are inter-related. A highly durable structure can have an initial strength that is lower than one which is not as durable (Fig. 7.2). A ship hull structure whose capacity would not degrade with time could have an initial capacity that was close to the minimum acceptable capacity.

Thus, evaluation of alternative structural design strategies involves definition of a combination of initial capacity, durability, and IMR strategies that will keep the hull structure capacity from falling below some minimum acceptable level.

What constitutes an acceptable combination of initial capacity, durability designed into the structure, and IMR program? This chapter will propose two fundamental approaches to help answer this question. The first approach is economics based. The second approach is historic performance based.

It is important to realize that these two approaches are complementary. They both should be used to assist development of judgments regarding alternative MSIP. No single approach is best or perfect for all purposes.

### Approaches

---

A variety of approaches have been developed, explored, and applied to assist evaluations of alternatives associated with structural capacity, durability and IMR programs. The combination of ship structural capacity, durability, and IMR programs will define alternative MSIP.

As noted in Chapter 3, the historic performance of crude carriers indicates that a principal focus of future MSIP should be directed at improving durability characteristics of ship hull structures. Performance of the current generation of crude carriers indicates that in most cases present IMR programs are doing a reasonably good job of keeping the hull capacity from falling below minimum acceptable levels. Only in the cases of what appear to have been poorly designed and constructed hull structures are more stringent IMR programs being required.

Reliability of the ship hull structure is involved in evaluations of alternatives concerning MSIP. If degradation of the hull structure is allowed to progress to the point where the capacity of the hull structure is reduced below some minimum acceptable level (Fig. 7.2), then the reliability of the hull structure becomes a concern.

The initial design and construction capacity combined with the durability design determines the frequency and intensity of the IMR program (Fig. 7.2). One of the key problems associated with evaluation of MSIP alternatives is identification of the desirable initial capacity and the lower acceptable level of capacity.

A basic objective an evaluation of MSIP alternatives for a ship hull structure is to identify a combination of initial capacity, durability (fatigue resistance and corrosion protection), and IMR that can keep the ship hull structure capacity above some minimum acceptable level. As a part of such evaluations, it is very desirable to conduct sensitivity analyses. The purpose of the sensitivity analyses is to examine how the ranking or assessment of MSIP alternatives might be changed if plausible variations in possible consequences, likelihoods, and preferences are considered.

## **Economics Based Approach**

The first approach to evaluation of MSIP alternatives can be characterized as an economics based approach. Fundamentally this approach attempts to define the combination of initial capacity, durability (fatigue and corrosion resistance), and IMR program that can bring the ship hull structure to the highest possible utility. Generally, this highest possible utility is defined as the MSIP program that can result in the lowest possible expected total initial and future costs.

### **Total Life Cycle Costs**

The present value of the total life cycle cost,  $C$ , associated with the performance of the ship hull structure can be expressed as:

$$C = C_O + C_F + C_I + C_M + C_R$$

where the subscript O refers to the initial cost, F refers to loss of serviceability cost, I refers to inspection cost, M refers to structural maintenance costs, and R refers to structural repair costs.

Assuming continuous discounting, each of the individual costs can be expressed as:

$$C_X = \sum C_x \exp(-r T_x)$$

where the uppercase subscript (X) refers to a type of cost, the lowercase subscript (x) refers to the specific cost, the summation is taken over the occasions or time for the category of cost,  $r$  is the net discount rate, and  $T$  is the time that the expense is incurred.

### **Uncertainties**

All of these categories of costs are variable and uncertain. Likelihoods (or probabilities) can be entered into the process in several ways. A traditional approach has been to focus on expected (or most probable) costs in which the estimated cost is multiplied by the likelihood or probability,  $P$ , of experiencing that cost:

$$E[C_X] = C_X P_X$$

The total expected cost can be written as:

$$E[C] = \sum C_X P_X$$

The expected initial cost includes the costs associated with the ship hull capacity, durability (degree of corrosion and fatigue protection provided including materials, redundancy, and robustness integrated in to the structure), and construction (including degree of quality assurance and control provided).

The expected future cost includes the costs associated loss of serviceability of the hull structure, and the costs associated with a given IMR program ( $C_F$ ,  $C_I$ ,  $C_M$ ,  $C_R$ ).

The likelihoods associated with each of the cost variables can be estimated on the basis of analyses, data, and experience.

### **Probability of Loss of Serviceability**

The probability of loss of serviceability (failure) of the ship hull structure,  $P_F$ , can be estimated from analyses of the performance characteristics of the ship hull structure under extreme loadings (Fig. 7.1) as follows:

$$P_F = P(R_u \leq S_m)$$

$P(\cdot)$  is read as the probability that the capacity of the hull structure is equal to or less than the imposed maximum loading.  $R_u$  is the ultimate capacity of the hull structure.  $S_m$  is the maximum loading imposed on the hull structure in a given period of time. Probabilistic reliability analyses can be used to characterize  $R_u$  and  $S_m$  [7.1-7.4].

If sufficient data is available on failures of comparable ship hull structures due to overloading, then this data can be used to verify the analyses and assist in characterization of the likelihoods of loss of serviceability [7.2-7.6].

If the hull capacity and maximum loadings can be reasonably characterized as being lognormally distributed, then:

$$P_F = 1 - \Phi \left[ \frac{\ln FS_{50}}{\sigma} \right] = 1 - \Phi [ \beta ]$$

$\Phi$  is the standard cumulative normal distribution for the value  $[\cdot]$ .

$FS_{50}$  is the central (median) factor of safety:

$$FS_{50} = \frac{R_{u50}}{S_{m50}}$$



$\sigma$  will be termed the total uncertainty measure.  $\sigma$  is the standard deviation of the distributions of the logarithms of capacity,  $\sigma_{Ru}$ , and maximum loadings,  $\sigma_{Sm}$ :

$$\sigma^2 = \sigma_{Ru}^2 + \sigma_{Sm}^2$$

$\beta$  is the Safety Index.  $\beta$  is a proxy or normalized measure of the probability of failure. As  $\beta$  increases (like a factor of safety), the likelihood of loss of serviceability decreases.  $\beta$  can be related to  $P_f$  approximately as follows:

$$P_f = 10^{-\beta}$$

or more precisely (for  $1 \leq \beta \leq 3$ ),

$$P_f = 0.475 \exp(-\beta^{1.6})$$

and,

$$\beta = [-\ln 2.1 P_f]^{0.625}$$

### Ultimate Limit State Capacity

Reserve strength characterizes the factor of safety between the design loadings and the ultimate capacity of the hull structure. An analytical characterization of the reserve strength can be expressed as the ratio of the ultimate capacity,  $R_u$ , to the design loading,  $S_d$  (Fig. 7.1):

$$RSR = \frac{R_u}{S_d}$$

RSR is termed the Reserve Strength Ratio. It is comparable to the nominal factor of safety that is used in design of individual elements within the hull structure. However, the RSR applies to the overall loading performance characteristics of the hull structure. Thus, it reflects the effects of materials (strength, ductility, fatigue resistance), the configuration of individual elements and how they are assembled into components, and how the components are assembled to result in the hull structure. Thus, the RSR reflects the effects of materials and redundancy.

**Residual Strength** - As important as the reserve strength is the residual strength,  $R_r$ , of the hull structure (Fig. 7.1). The residual strength is the load carrying capacity of the hull structure after the peak load resistance has been exceeded. It is desirable to have a residual strength that is

is high as possible, representing what is commonly termed a "ductile failure."

$R_r$  is determined by the materials, redundancy, and ductility (ability to absorb large strains and dissipate plastic strain energy). In particular, the buckling characteristics of the deck and bottom hull components play major roles in determining the characteristics of the residual strength [7.5-7.7].

In the following developments, the maximum load capacity,  $R_u$ , will be used to characterize the effective capacity of the hull structure at its Ultimate Limit State (ULS, complete loss of serviceability). It is important to recognize that a variety of hull structure loading factors (frequency, duration, periodicity) and structural performance factors (redundancy, ductility, strain rate and cyclic strain degradation) can influence the "effective"  $R_u$  [7.6]. Research is being conducted to better define the influences of the loading and performance factors on the effective  $R_u$  [7.9]. The effects of these factors can be to either increase  $R_u$  or decrease  $R_u$  as defined from static analyses of the ULS capacity characteristics of hull structures.

**Robustness** - Robustness is characterized as the degree of damage and defect tolerance of the hull structure. As for  $R_r$ , this is a design characteristic that has been incorporated into VLCCs and ULCCs by virtue of the historic design practices for these hull structures. As discussed in Chapter 2, this design consideration is a major factor in ASIP (design for damage tolerance), because of the need to design very light weight ("efficient") structures.

From studies of structural systems that have been conducted [7.10, 7.11], robustness results from a combination of three major factors:

- 1) **Redundancy (degree of indeterminacy),**
- 2) **Ductility (ability to absorb repeated plastic strains), and**
- 3) **Excess capacity (to provide alternative load paths given defects or damage that results in loss of capacity of other load paths).**

Robustness becomes a major consideration for insuring high degrees of damage tolerance in the cases of groundings and collisions [7.12-7.14]. Robustness is also a major consideration as the configuration of the hull structure is changed to make it "more efficient." Less redundancy, less ductility, and less excess strength in alternative load paths can lead to less robustness. The result of too much "efficiency" in the hull structure configuration can be a structure that is very damage or defect intolerant. The price of such efficiency will be intensified IMR programs.

At the present time, there are no definitive engineering or design guidelines to help determine what constitutes adequate degrees of robust-

ness in the hull structure. Present procedures consist of examining **high likelihood accidents** (e.g. collisions, groundings) and **high likelihood defects** (e.g. corroded or fatigue degradation) and insuring that the hull structure will not lose significant capacity or endanger its other safety functions (e.g. leak integrity, stability) [7.9].

**Factor of Safety** - The reserve strength designed into the ship hull structure can be expressed in a variety of ways. The first is through  $FS_{50}$ . Based on the foregoing developments:

$$FS_{50} = \exp(\beta \sigma)$$

For example, if the desired Safety Index for the ship hull structure were  $\beta = 3.5$  and the total uncertainty measure were  $\sigma = 0.5$ ,  $FS_{50} = 5.8$ ; if  $\sigma = 1.0$ ,  $FS_{50} = 33$ . The required central factor of safety is very sensitive to the evaluation of uncertainties reflected in  $\sigma$  (Fig. 7.3).

**Reserve Strength Ratio** - Based on the foregoing developments, the desirable design RSR can be expressed as:

$$RSR = R_s \exp(\beta \sigma)$$

$R_s$  is the ratio of the median maximum loading,  $S_{m50}$ , to the design loading,  $S_d$ . Given the use of a 99-th percentile (average return period of 100-years) maximum loading (assuming lognormally distributed  $S_m$ ):

$$R_s = \exp(-2.33 \sigma_s)$$

Figure 7.4 shows the relationship between the design RSR and the product of the Safety Index and the total uncertainty measure ( $\beta \sigma$ ) as a function of  $R_s$ . For example, a  $(\beta \sigma) = 2.8$  and  $R_s = 0.2$  indicates  $RSR = 5.0$ ; for  $R_s = 0.1$ ,  $RSR = 1.5$ .

Such RSRs appear to be incorporated into the hull structures of the present generation of VLCCs and ULCCs (Fig. 7.5). Recently performed analyses of the capacities of rule designed hull structures indicates RSRs in the range of 1.5 to in excess of 3 (depending on loading conditions and non-linear structural analysis assumptions) [7.1-7.7].

### Utility Maximization Assessments

The evaluation of alternative IMR programs ("maintenance effort") can be assessed in terms of costs and availability of the vessel to perform its intended functions (loss of serviceability costs). Figure 7.6 shows one such evaluation [7.6]. As expressed earlier in this chapter, as the maintenance effort intensifies, the costs associated with inspections and maintenance

goes up. However, the costs associated with loss of serviceability and unanticipated or unscheduled repair costs goes down. The search is for the level of the maintenance effort that will optimize the use of resources.

A lower bound is placed on the maintenance effort by "minimum mandatory requirements" (Fig. 7.6). These requirements can be expressed in terms of either classification society requirements or those imposed by regulatory authorities. These minimum requirements do not assure that the maintenance effort is "optimized." They only attempt to assure that the minimum safety or reliability characteristics of the ship hull structure are not compromised.

The upper bound on the maintenance effort is determined by the "limit for resources." This limit is determined by the profitability attributed to the operations of the ship. Without adequate profit, there will not be adequate resources available to assure reliability and high degrees of durability. Profit is a quantity that is determined how the value of the services are assessed, how the costs associated with those services are assessed, and how time related factors are assessed (e.g. maximize short or long term gains). It is here that organization and organization incentive and cultural factors are critically important in defining the resources that can be made available to assure durability and adequate MSIP.

In the following developments, the process of defining what constitutes an adequate MSIP program, including the IMR maintenance alternatives will be expressed as a utility maximization process. The objective of the utility maximization process can be expressed as an expected total cost minimization (Fig. 7.7):

$$E[C]_{\min} = [ \sum C_X P_X ]_{\min}$$

The expected value costs associated with an alternative is the average monetary result per decision that would be realized if the decision maker accepted the alternative over a series of identical repeated trials. The expected value concept is a philosophy for consistent decision making, which if practiced consistently, can bring the sum total of the utilities of the decision to the highest possible level [7.8, 7.15].

The expected value is not an absolute measure of a monetary outcome. It is incorrect to believe that the expected value is the most probable result of selecting an alternative. If one wanted to determine the probabilities of different magnitudes of utilities, then likelihoods could be assigned to each of the cost elements and these likelihoods propagated through the cost and likelihood evaluations to develop probability distributions of the potential utilities.

In a simplified framework (assuming independent normally distributed cost and likelihood variables and small variances), this can be done as follows:

$$E[C] = \sum \overline{C_X} \overline{P_X}$$

where the variables with over-strikes indicate mean (average, expected) values. The coefficient of variation (COV = V, ratio of standard deviation to mean value) of the expected cost can be estimated as:

$$V^2_{E[C]} = [\sum V^2_{C_X} + \sum V^2_{P_X}]$$

In this manner, the decision maker can gain an appreciation of the uncertainty associated with the expected total cost, and be able to estimate the upside and downside implications of the MSIP alternative.

### **Probability of Loss of Serviceability Based Cost Evaluation**

Given that the costs associated with a given MSIP IMR alternative can be reasonably related linearly to the logarithm of  $P_F$ , then:

$$E[C_0] = P_0 (C_0 + \Delta C_0 \text{ Log}_{10} P_F)$$

where  $C_0$  is the initial cost versus  $P_F$  intercept, and  $\Delta C_0$  is the slope of the initial cost curve. Differentiating the sum of initial and future cost with respect to  $P_F$  to find the point of zero slope (minimum total cost point) gives the  $P_F$  that produces the lowest total cost ( $P_{f_0}$ ):

$$P_{f_0} = \frac{0.435}{R_c}$$

$R_c$  (cost ratio) is the ratio of the present valued future MSIP cost,  $C_F$ , to the expected cost needed to decrease  $P_F$  by a factor of 10:

$$R_c = \frac{C_F}{P_0 \Delta C_0}$$

For example, if  $C_F = \$100$  millions, and  $P_0 \Delta C_0 = \$10$  millions, then  $P_{f_0} = 0.0438$  (lifetime value). Assuming a useful lifetime of 20 years,  $P_{F_{0a}}$  (average annual) =  $2 \times 10^{-3}$  or 0.2 % per year. The MSIP IMR program that could develop  $P_{f_0a}$  in the range of 0.2 % per year would be chosen for implementation.

### **Hull Structure Weight - Cost Evaluation**

An alternative MSIP IMR utility evaluation could be formulated as follows. For example, let the initial cost of the ship hull structure be linearly proportional to the structure weight,  $W$ :

---

## Marine Structural Integrity Programs

---

$$C_{EI} = I_0 + (m_i) W$$

where  $I_0$  is the initial cost - zero weight intercept and  $m_i$  is the slope of the initial cost - weight relationship (dollars per ton)

Let the hull structure weight be composed of two parts; one that is durability (e.g. fatigue) sensitive,  $W_f$ , and one that is not,  $W_n$  ( $W = W_f + W_n$ ).

Let the likelihood of future maintenance costs associated with the ship hull structure be inversely proportional to the cube (slope of S-N curve) of the portion of steel weight that is fatigue sensitive:

$$C_{EF} = C_{Ff} P_f = C_{Ff} \frac{K_f}{W_f^3}$$

Differentiating the initial and future costs and equating to zero to define the optimum weight of the fatigue sensitive steel,  $W_{fo}$ :

$$W_{fo} = \left[ \frac{3 C_{Ff} K_f}{m_i} \right]^{0.25}$$

Assume that for  $W = 20,000$  tons and  $W_f = 2,500$  tons,  $P_f = 1.0$ , and  $C_{Ff} = \$100$  millions. Also, that  $C_{EI} = \$20$  millions +  $m_i$  (20,000 tons); thus,  $m_i = 4 \times 10^{-3}$  \$ millions per ton. Given these assumptions,  $W_{fo} = 5,850$  tons; the weight of the ship structure needs to be increased by 17 percent to achieve the "optimum" durability (added 3,350 tons of fatigue sensitive steel).

As a further development, let the hull structure weight be composed of three parts; one that is fatigue sensitive (e.g. side shell longitudinals),  $W_f$ , one that is corrosion protection sensitive (e.g. ballast tanks walls),  $W_c$ , and one that is not durability (corrosion, fatigue) sensitive:

$$W = W_n + W_f + W_c$$

Let the likelihood of future maintenance costs associated with the corrosion sensitive portion of the ship hull structure weight be inversely proportional to  $W_c$ :

$$C_{EFC} = C_{FC} P_c = C_{FC} \frac{K_c}{W_c}$$

Differentiating the initial and future costs and equating to zero to define the optimum weight of the corrosion sensitive steel gives:

$$W_{co} = \left[ \frac{C_{FC} K_c}{m_i} \right]^{0.50}$$

Extending the previous example to include 2,500 tons of MSIP sensitive steel ( $W_c = 2,500$  tons), assume that for  $W = 20,000$  tons,  $W_f = 2,500$  tons,  $W_c = 2,500$  tons,  $P_f = P_c = 1.0$ , and  $C_{Ff} = C_{Fc} = \$50$  millions. Also, as before that  $C_{EI} = \$20$  millions +  $m_i$  (20,000 tons); thus,  $m_i = 4 \times 10^{-3}$  \$ millions per ton. Given these assumptions,  $W_{fo} = 4,918$  tons;  $W_{fc} = 5,590$  tons and  $W_n = 15,000$  tons. Thus, the total weight of the ship hull steel is increased to 25,508 tons or increased by 28 percent to achieve an optimum MSIP IMR strategy. Given the information summarized in Figures 1.2 and 1.3, this would seem to be a realistic example.

A variety of sophisticated probability based economic models have been developed and used in evaluations of elements that comprise MSIP [7.16-7.19].

### Historic Performance Based Approach

This approach is based on experience with the performance of comparable ship hull structures. The general premise of this approach is that society, the profession, and industry over time and through experience define what constitutes an acceptable MSIP [7.3, 7.19-7.21].

This second category of approach is actually just a different way in which MSIP are evaluated. The economics based approach attempts to define the MSIP measures that should be assumed in the future. The historic performance base approach defines acceptable MSIP as a function of time and experience.

Experience can be reflected in actuarial data on the performance of ship structures. Alternatively, it can be reflected in current design codes, standards, and guidelines.

The use of historic data to make judgements on alternative MSIP encounters several problems. Data from which historical information on satisfactory and unsatisfactory MSIP performance can be derived is extremely limited. Data on ship casualties reflects a wide variety of causes and effects. **The majority of ship casualties are not due to insufficient structural capacity, but are due to human and organizational errors.**

Definitive data on ship durability is very limited. There is little organized, recorded, and analyzed historic data on crude carrier hull structure durability and the effectiveness and efficiency of alternative MSIP. At the present time, one can only reflect that tankers, such as the T2's built during the second world war, seemed to be much more durable. Some of these ships are still operating, well beyond their intended lifetimes.

As summarized in Chapters 1 and 3, it seems to have been since the 1970's that hull structure capacity margins and maintenance programs have been eroded to the point where hull structure durability is a concern (both financially and safety wise) [7.22, 7.23]. Both design and construction quality seem have sometimes lagged relative to the explosion in size and the strength of steels being used in fabrication. This erosion seems to have been in direct response to objectives to lower initial or first costs, with secondary consideration given to life cycle costs.

Figure 7.8 summarizes annual probabilities of failure and consequences of failure associated with a wide variety of engineered structures and facilities [7.15, 7.21]. The likelihoods are based on actual historical rates of failure. The ranges of consequences are based on the average ranges of monetary costs (1984 U.S. dollars) and fatalities that have been associated with the failures.

The area identified with merchant shipping includes all types of commercial shipping (refer to Tables 3.1 and 3.2). Present performance data [7.14] indicates that tankers have likelihoods of failure that are about a factor of ten lower than the average indicated for all merchant shipping ( $P_F \approx 10^{-3}$  per year).

The two lines shown in Fig. 7.8 indicate what can be termed "acceptable" and "marginally accepted" combinations of likelihoods and consequences. These lines represent an evaluation of how a society might make tradeoffs between likelihoods and consequences.

The lines that divide acceptable ( $P_{Fa}$ ) and marginally accepted ( $P_{Fm}$ ) combinations of annual likelihoods of failure,  $P_F$ , and consequences,  $C_F$ , can be expressed as follows:

$$P_{Fa} = 10^{-(0.74 \log C_F + 1.12)}$$

$$P_{Fm} = 10^{-(0.60 \log C_F + 0.95)}$$

In these expressions, the costs associated with the failures have been expressed in terms of millions of 1990 United States dollars.

**Causes of Casualties** - The accident frequencies shown in Fig. 7.8 are attributable to all causes. The causes of tanker casualties (loss of the ship hull) have been analyzed for the period 1979 - 1987 (Fig. 7.9) [7.21, 7.22, 7.25]. It is clear that non-hull structure related causes dominate. Hull and machinery together account for about 27 percent of the casualties, with machinery accounting for more than half of these casualties.

Based on these data, it is reasonable to assume that about 80 percent of the accidents causing failure are non-structurally related. Thus, the  $P_F$ 's indicated in Fig 7.8 and the foregoing equations should be reduced by



about 80 percent to develop a historic basis for definition of the hull structure related reliability.

The equation to define  $P_{Fa}$  might be used to help define the likelihood of ship hull failure associated with exceeding the capacity of the hull when it is new. The equation to define  $P_{Fm}$  might be used to help define the minimum acceptable  $P_F$  that could be developed during the intended life of the ship hull structure. The results would need to be multiplied by 0.2 to estimate the proportion of failures attributable to ship hull structures, or:

$$P_{Fa} = (0.2) 10^{-(0.74 \log C_F + 1.12)}$$

$$P_{Fm} = (0.2) 10^{-(0.60 \log C_F + 0.95)}$$

For example, if  $C_F = \$100$  millions,  $P_{Fa} = 5.0 \times 10^{-4}$  and  $P_{Fm} = 1.4 \times 10^{-3}$  per year. This would equate to annual Safety Indices of  $\beta_a = 3.3$  and  $\beta_m = 3.0$ .

**Minimum FS<sub>50</sub>** -  $P_{Fm}$  could be defined by  $C_F$ , then given an evaluation of the uncertainties associated with the maximum loadings and capacities, the minimum acceptable central factors of safety, FS<sub>50</sub>, could be evaluated (Fig. 7.10). The minimum FS<sub>50</sub> is relatively insensitive to  $C_F$ 's in the range of \$50 millions to \$300 million for  $\sigma$  in the range of 0.4 to 0.8. The minimum FS<sub>50</sub> is very sensitive to the range of  $C_F$  for  $\sigma$  above 1.0.

**Minimum RSR** - The minimum RSR can be developed in a comparable manner (Fig. 7.11). In this case the results have been shown for a total uncertainty measure  $\sigma = 1.0$  to  $\sigma = 0.8$ ; loading ratios,  $R_s$ , in the range of 0.1 to 0.2; and  $C_F$  in the range of \$50 millions to \$300 millions. The minimum RSR is relatively insensitive to the range of  $C_F$  for  $R_s = 0.1$  and  $\sigma = 0.8$  to 1.0, and for  $R_s = 0.2$  and  $\sigma = 0.8$ . The minimum RSR is very sensitive to  $C_F$  for  $R_s = 0.2$  and  $\sigma = 1.0$ .

Given an evaluation of the likelihood characteristics associated with the maximum loadings that the ship hull structure might experience during its lifetime (median expected maximum loading,  $Sm_{50}$ ), the minimum acceptable median hull capacity,  $Ru_{50}$  could be evaluated (Fig 7.1).

This minimum capacity could also be compared with the minimum capacity implied in Classification guidelines. It would be important to recognize projected future changes or trends in these minimum guidelines that might develop during the intended life of the ship.

---

**Evaluation of Fatigue & Corrosion Durability Alternatives**

---

**Fatigue Durability Evaluation**

**Formulation** - A principal MSIP IMR alternative is the fatigue durability that should be incorporated in to the ship hull structure.

Given that the time to fatigue failure of a given CSD can be expressed as  $T$ , and the service life of the CSD can be expressed as  $T_s$ , and that these variables can be reasonably characterized with lognormal distributions:

$$\beta_f = \frac{\ln(T_{50} / T_s)}{\sigma_{\ln T}}$$

where  $T_{50}$  is the median (50-percentile) time to failure of a CSD and  $T_s$  is the service life of the CSD (e.g. 20 years), and  $\sigma_{\ln T}$  is a measure of the uncertainties in the time to fatigue failures (standard deviation of the logarithms of the times to failure).

The likelihood of fatigue failures in the CSD of the ship as a function of time can be reasonably expressed as [7., 7.]:

$$\beta_{ft} = \beta_{fD} - \frac{\ln(t / T_s)}{\sigma_{\ln T}}$$

where  $\beta_{ft}$  is the Safety Index at any time,  $t$ , during the service life,  $T_s$ ;  $\beta_{fD}$  is the Safety Index that results from the design and construction.

$\sigma_{\ln T}$  can be estimated as follows:

$$\sigma_{\ln T}^2 = \ln [(1 + V_D^2) (1 + V_N^2)^{m^2} (1 + V_A^2)]$$

where  $V_D$  is the COV of fatigue damage at failure,  $V_N$  is the COV associated with the S-N curves,  $m^2$  is the square of the slope of the S-N curve, and  $V_A$  is the COV associated with the stress analyses. Typical values of these quantities for CSD would be  $V_D = 0.30$ ,  $V_N = 0.50$ ,  $m = 3.0$ , and  $V_A = 0.25$ .

Thus,  $\sigma_{\ln T}^2 = 2.2$  and  $\sigma_{\ln T} = 1.5$ .

Figure 7.12 shows the change in the fatigue Safety Index (probability of fatigue failure) as a function of the ratio of the exposure period,  $t$ , to the service life,  $T_s$ , and the variability in the time to fatigue failures for two design Safety Indexes ( $\beta_{fD} = 2.5$  and  $3.0$ ). The design Safety Index is reached only at the end of the service life. It is substantially greater at earlier times.

Greater uncertainties in the times to failure imply more rapid decreases in  $\beta$  as a function of time.

The foregoing developments can be used to express the relationships between the median time to failure,  $T_{50}$ , the service life,  $T_S$ , the variability in time to fatigue failure,  $\sigma_{\ln T}$ , and the fatigue design Safety Index. Figure 7.13 shows such relationships. The ratio  $T_{50}/T_S$  can be thought of as the factor of safety that must be used on the service life for a given uncertainty in the fatigue life to achieve a desired fatigue Safety Index at the end of the service life. Large Safety Indices and uncertainties imply very large factors of safety on the service life.

**Example Application** - An example application of these developments is illustrated in Fig. 7.14. The numbers of fatigue failures (through thickness fractures) that can be anticipated in a ship hull structure during 5 year periods through out a service life of 20 years are shown. It was assumed that the ship hull structure had 10,000 CSD whose fatigue strength had been uniformly determined by  $\beta_D$ 's ranging from 1.0 to 3.0 ( $\sigma$  assumed = 1.0).

The ship that had its CSD  $\beta_D = 2.5$  had 6 fatigue failures during the first 10 years as compared with the ship that had its CSD  $\beta_D = 1.0$  with 203 fatigue failures during the same time period.

Figure 7.15. summarizes the total number of fractures that could be expected in a 20 year life of the example ship CSD as a function of the fatigue Safety Index that resulted from the design and construction processes. The number of fractures for a 20-year lifetime ranges from less than 20 to in excess of 1,000.

The foregoing information has been used to estimate the total life-cycle costs associated with the fatigue fractures (Fig. 7.16). It was assumed that the inspection process was capable of detecting the through-wall fractures that were developed at 5-year intervals, and that these fractures were immediately repaired to the initial condition (three IMR cycles). It was assumed that the initial cost differential between designing and constructing for a CSD  $\beta_D = 1.0$  to CSD  $\beta_D = 3.0$  cost \$10 millions. Further, it was assumed that the total cost associated with each fatigue fractures was \$10,000 (inspection, repair, out of service). IMR costs were discounted at rates between zero and 10 percent.

The results indicate a fatigue design Safety Index of about  $\beta = 2.0$  is optimum for a zero percent net discount rate. As would be expected, as the net discount rate increases (lessening the value of future expenditures), the optimum fatigue design safety index becomes smaller.

Other IMR alternatives including lengthening and shortening the inspection and repair periods could be investigated and an "optimum" program identified for an MSIP.

### **Corrosion Durability Evaluation**

A corrosion durability evaluation can be developed in a manner similar to that for fatigue durability. It is assumed that the capacity of a CSD,  $R_u$ , can be expressed as:

$$R_u = S_f(t_i - c)$$

where  $S_f$  is the failure stress per unit width of the CSD,  $t_i$  is the initial thickness of the CSD, and  $c$  is the corrosion wastage. Note that corrosion allowances such as are included in some classification rules would be incorporated in  $t_i$ .

The corrosion wastage can be expressed as:

$$c = R_c T$$

where  $R_c$  is an average corrosion rate for a given period of time, CSD location, and protection.  $T$  is the corrosion exposure time. For coated surfaces,  $T$  can be defined as the time associated with loss of effectiveness of the coating. For unprotected surfaces,  $T$  would be referenced to the time of initiating service of the CSD.

Note that  $R_u$  is a function of time, just as for the formulation for fatigue durability. The central (50-th percentile) initial factor of safety,  $FS_{50i}$ , associated with the design and construction of the CSD can be expressed as:

$$FS_{50i} = \frac{S_{f50} t_{i50}}{S_{m50}}$$

where  $S_{m50}$  is the median maximum design stress per unit width on the CSD. Any corrosion allowances defined for the initial plate thickness would be incorporated into the central factor of safety.

Let the corrosion or wastage limit,  $L_c$ , be expressed as:

$$L_c = \frac{c}{t_{i50}} = \frac{R_c T}{t_i}$$

Expressing the likelihood of a corrosion failure,  $P_{fc}$ , as:

$$P_{fc} = P[t_i - c \leq t_L]$$

where  $t_L$  is the limiting plate thickness of the CSD. Assuming lognormally distributed corrosion and plate thickness variables, the corrosion Safety Index,  $\beta_c$ , can be expressed as:

$$\beta_c = \frac{\ln (t_o - R_c T)}{\sigma_{\ln t}}$$

The change of the corrosion Safety Index as a function of time after the corrosion protection has lost its effectiveness can be expressed as:

$$\beta_c(T) = \frac{\ln \left\{ \left( 1 - \frac{R_c T}{t_o} \right) FS_{50i} \right\}}{\sigma_{\ln t}}$$

The corrosion limit can be expressed as:

$$L_c = 1 - \frac{\exp (\beta_c \sigma_{\ln t})}{FS_{50i}}$$

where  $\sigma_{\ln t}$  is the uncertainty measure (standard deviation of the logarithms) associated with the corrosion rate,  $R_c$ , the time to corrosion protection breakdown,  $T$ , the uncertainties associated with determination of the limiting plate thickness,  $t_L$ . Very large variabilities are associated with corrosion rates of CSD in various parts of tanker hull structures. For example, the database developed and described in references [7.29] and [7.30] indicate  $\sigma_{\ln R_c} = 0.5$  to 1.5.

For example, given a corrosion safety index of  $\beta_c = 2.0$  (about 1/100 chance of exceeding the prescribed limit in a given year), an uncertainty measure  $\sigma_{\ln t} = 1.0$ , and a central factor of safety of 10, the resulting corrosion limit would be  $L_c = 26$  percent.

Figure 7.17 summarizes results of the foregoing developments in terms of the allowable corrosion ( $L_c$  = thickness at a given time divided by the original thickness), the initial central factor of safety,  $FS_{50i}$ , and the product of the Safety Index and the uncertainty measure,  $\beta_c \sigma_{\ln t}$ . As would be expected, for large safety indices and uncertainty measures, very small allowable corrosion is indicated. As the initial factor of safety is decreased, the allowable corrosion is decreased. For example, for an initial factor of safety of 10, and a corrosion Safety Index of 2, a corrosion limit of  $L_c = 26$  percent is indicated.

Figure 7.18 summarizes these results in terms of the relationship between the corrosion limit,  $L_c$ , and the corrosion Safety Index for various

central factors of safety, given an uncertainty measure  $\sigma_{\text{Int}} = 1.0$  (a reasonable average for the CSD corrosion data cited earlier). For example, for a corrosion Safety Index of 2.5 and an initial factor of safety of 15, the corrosion limit is  $L_c = 20$  percent.

An understanding of the change in the corrosion Safety Index as a function of the corrosion exposure period is illustrated in Figures 7.19 and 7.20. These examples have been based on an initial CSD plate thickness of 15 mm, average corrosion rates of  $R_c = 0.1$  to  $0.2$  mm/year (Fig. 7.19) and  $R_c = 0.5$  to  $1.0$  mm/year (Fig. 7.20), a total uncertainty  $\sigma_{\text{Int}} = 1.0$ , and initial factors of safety of 5 to 10. As the corrosion rate increases, the rate of increase of the probability of corrosion failure (exceeding a specified limit) in a given period increases. The initial factor of safety has little effect on the rate of change of the probability of failure as a function of corrosion exposure time.

For example, for CSDs that had  $R_c = 0.5$  mm/year and  $FS = 10$ , a corrosion safety index of 2.0 would be achieved in about 8 years of corrosion exposure; for CSDs that had  $R_c = 1.0$  mm/year, a corrosion Safety Index of 2.0 would be achieved in about 4 years.

**Example Application** - An example application of the foregoing could be developed as follows. Assume that ballast tank CSDs have been designed in a double hull ULCC with  $FS_{50i} = 10$ . The initial thickness of the CSDs is 15 mm. The expected (average) corrosion rate during exposure of the steel in these tanks is 0.5 mm/year. The total uncertainty associated with the corrosion effects is  $\sigma_{\text{Int}} = 1.0$ . The total surface area of the ballast tanks is 400,000 ft<sup>2</sup>.

Three corrosion durability alternatives are being considered: 1) no initial protective coating and cathodic protection, 2) a 5-year expected life coating and cathodic protection system for all ballast tank surfaces, and 3) a 10-year expected life coating and cathodic protection system for all ballast tank surfaces. The corrosion limit has been defined so that the minimum corrosion Safety Index is 2.0;  $L_c = 25$  percent wastage. Periodic surveys will be conducted to assure that this limit is detected.

It will be assumed that it costs \$10 ft<sup>2</sup> to provide the 5-year corrosion protection and \$15 ft<sup>2</sup> to provide the 10-year corrosion system when the ship is built. For the 5-year and 10-year protection systems, it will cost \$20 ft<sup>2</sup> and \$25 ft<sup>2</sup>, respectively, when the protection must be renewed. The initial no protection system will be designed with a 10 percent corrosion allowance on the CSD that will cost \$4,000 per ton. The alternatives will be assessed for a 20-year life system. Net discount rates of zero and 10 percent will be considered.

In the case of the no initial protective coating system, the corrosion limit will be expected to be exceeded in 10 years. At this time, a 10-year protection system will be installed.

In the case of the initial 5-year protection system, the corrosion limit will be expected to be exceeded in 13 years. At this time, 10-year protection system will be installed.

In the case of the initial 10-year protection system, the corrosion limit will be exceeded in 18 years. At this time, a 5-year protection will be installed.

The results of this analysis are summarized in Fig. 7-21. The no initial protection system has the greatest present valued cost for both zero and 10 percent net discount rates. The 5-year and 10-year protection systems have a present valued total cost less than half of the initial no protection system. There is little difference between the 5-year and 10-year protection systems. These results are in substantial agreement with those from previous studies [7.31-7.33].

---

## **Summary**

---

This chapter has developed a method of interpreting economics and historic performance data on crude carriers. The method was used to assist evaluations of alternative MSIP programs. The basic technology required to implement these procedures exists.

Specific developments have addressed methods to define desirable combinations of initial capacity (reflecting materials, redundancy, and robustness considerations), durability (reflecting fatigue cracking and corrosion provisions), and IMR (reflecting inspections and repair strategies). Approaches for defining minimum acceptable capacity characteristics have been defined (providing bases to determine minimum CSD strength characteristics and inspection intervals).

There are many different combinations of initial capacity, design and construction for durability, and IMR programs that can be used to develop tanker hull structure systems that will possess desirable and acceptable combinations of structural reliability and durability.

Development of future design guidelines for CSD in VLCCs and ULCCS should address in an integrated manner the desirable combinations of initial capacity, degrees of durability, IMR, and minimum capacity. Only in this way can a coherent CSD design guideline be developed.

---

**References**

---

- [7.1] Mansour, A. E., and Faulkner, D. (1972). *On Applying the Statistical Approach to Extreme Sea Loads and Ship Hull Strength*. Royal Institution of Naval Architects, London, England.
- [7.2] Kaplan, P., Benatar, M., Bentson, J., and Adchtariedes, T. A. (1984). *Analysis and Assessment of Major Uncertainties Associated with Ship Hull Ultimate Strength*. Ship Structure Committee Report No. SSC-322.
- [7.3] Thyamballi, A. K., Chen, Y-K, and Chen, H-H (1987). *Deterministic and Reliability Based Retrospective Strength Assessments of Oceangoing Vessels*. Paper No. 6, Annual Meeting, The Society of Naval Architects and Marine Engineers.
- [7.4] Akita. U. (1988). *Reliability and Damage of Ship Structures, Marine Structures*, Vol. 1.
- [7.5] Rutherford, S. E., and Caldwell, J. B. (1990). *Ultimate Longitudinal Strength of Ships: A Case Study*. Paper No. 14, Annual Meeting, The Society of Naval Architects and Marine Engineers.
- [7.6] Skaar, K. T., Valsgård, Köhler, P. E., and Mürer, C. (1987). *How Low Can Steel Weight Go With Safety and Economy ?*, *Proceedings Third International Conference on Practical Design of Ships and Mobile Offshore Units, PRADS'87*, Trondheim, Norway.
- [7.7] Smith, C. S., and Dow, R. S. (1981). *Residual Strength of Damaged Steel Ships and Offshore Structures*, *Journal of Construction Steel Research*, Vol 1, No. 4.
- [7.8] Bea, R. G. (1991). *Reliability Based Design Criteria for Coastal and Ocean Structures*, Institution of Engineers Australia, Barton, ACT.
- [7.9] Bea, R. G. (1991). *Structural Reliability: Design and Requalification of Offshore Platforms*, *Proceedings International Workshop on Reliability of Offshore Operations*, National Institute of Standards and Technology, Gaithersburg, Maryland.
- [7.10] Das, P. K. and Garside, J. F. (1991). *Structural Redundancy for Discrete and Continuous Systems*, Final Draft Report of Project No. SR-1316, Ship Structure Committee.
- [7.11] Dee, R. S. (1990). *Offshore Structural System Reliability: Wave-Loading Modeling, System Behavior, and Analysis*, Department of Civil Engineering, Stanford University, Report No. RMS-6.



[7.12] Van Mater, P. R., Jr., Giannotti, J. G., Jones, N., and Genalis, P. (1978). *Critical Evaluation of Low-Energy Ship Collision-Damage Theories and Design Methodologies, Volume I: Evaluation and Recommendations and Volume II: Literature Search and Review*, Ship Structures Committee Reports Nos. SSC-284 and SSC-285.

[7.13] Jones, N. (1978). *A Literature Survey on the Collision and Grounding Protection of Ships*, Ship Structure Committee Report No. SSC-283.

[7.14] Committee on Tank Vessel Design, Marine Board (1991). *Tanker Spills: Prevention by Design*, National Academy of Engineering, National Academy Press, Washington, D. C.

[7.15] Bea, R. G. (1991). *Offshore Platform Reliability Acceptance Criteria*, *Society of Petroleum Engineers Journal of Drilling Engineering*, June.

[7.16] Kristoffersen, K. and Brakas, M. J. (1986). *Methodology and Computer Analysis for Optimization of Maintenance*, *Proceedings of the Asian Maintenance Management Conference*, Singapore.

[7.17] Ferregut, C. (1987). *Methodologies for the selection of Safety Factors and Safety Levels in the Design of Marine Structures*, *Proceedings Marine Structural Reliability Symposium*, Arlington, Virginia.

[7.18] Schall, G., and Öestergaard (1991). *Planing of Inspection and Repair for Ship Operation*, *Proceedings Marine Structural Inspection, Maintenance and Monitoring Symposium*, Arlington, Virginia.

[7.19] Abrahamsen, E., Nordenström, N., and Røren, E. M. Q. (1970). *Design and Reliability of Ship Structures*, Paper NO. 3, Spring Meeting. Society of Naval Architects and Marine Engineers, Washington, D. C.

[7.20] Bøe, C., Mathiesen, T. C., and Røren, E. M. Q. (1976). *Reliability Design Criteria for Shipping Industry*, *Publication No. 93, Det Norske Veritas*, Høvik, Norway.

[7.21] Skaar, K. T., Aage, C., Ashe, G. M., Babinet, J., Bea, R. G., Clarke, J. D., Gnone, E., and Nitta, A. (1991). *Inspection, Monitoring, Maintenance / Repair, Report of Committee V.2, Proceedings 11th International Ship & Offshore Structures Congress*, China.

[7.22] Hart, D. K., Rutherford, S. E., and Wickham, A. H. S. (1985). *Structural Reliability Analysis of Stiffened Panels*, The Royal Institution of Naval Architects, London, England.

[7.23] Ferguson, J. (1990). *Extending the Life of Existing Tanker Hulls: Structural Trends in Today's Tanker Newbuildings, Crude Oil Carriers in the 1990's Symposium*, Lloyd's Register of Shipping, London, England.

[7.24] Mobil Oil Corporation (1987). *Structural Design Concerns with Respect to the New Generation of Tankers, Tanker Structure Co-Operative Forum.*

[7.25] Köhler, P.E. and Valsgård, S. (1988). *Advanced Ship Structural Design and Maintenance, Proceedings 11th Ship Technology and Research (STAR) Symposium*, Society of Naval Architects and Marine Engineers Spring Meeting, Pittsburgh, Pa.

[7.26] Wirsching, P. H., and Chen, Y-N (1987). *Considerations of Probability-Based Fatigue Design for Marine Structures, Proceedings Structural Reliability Symposium*, Arlington, Virginia.

[7.27] Nikolaidis, E. and Kaplan, P. (1991). *Uncertainties in Stress Analyses On Marine Structures*, Ship Structure Committee Report No. SSC-363.

[7.28] Shinozuka, M. (1991). *Relation of Inspection Findings to Fatigue Reliability*. Ship Structure Committee Report No. SSC-355.

[7.29] Pollard, R. R. (1991). *Evaluation of Corrosion Damage in Crude & Product Carriers*, Report No. SMP-2-1, Dept. of Naval Architecture & Offshore Engineering, Univ. of Cal. at Berkeley.

[7.30] Huang, Rong (1989). *Corrosion Rate Determination*, Tanker Structure Co-Operative Forum, London, England.

[7.31] White, G. J., and Ayyub, B. M. (1991). *A Probabilistic Approach for Determining the Effect of Corrosion on the Life Expectancy of Marine Structures, Proceedings Marine Structural Inspection, Maintenance and Monitoring Symposium*, Arlington, Virginia.

[7.32] Research Committee for Prevention of Ship Corrosion (1987). *A Summary of "Guide to Protection Against Corrosions of Ship's Hull and Equipment, NK Technical Bulletin.*

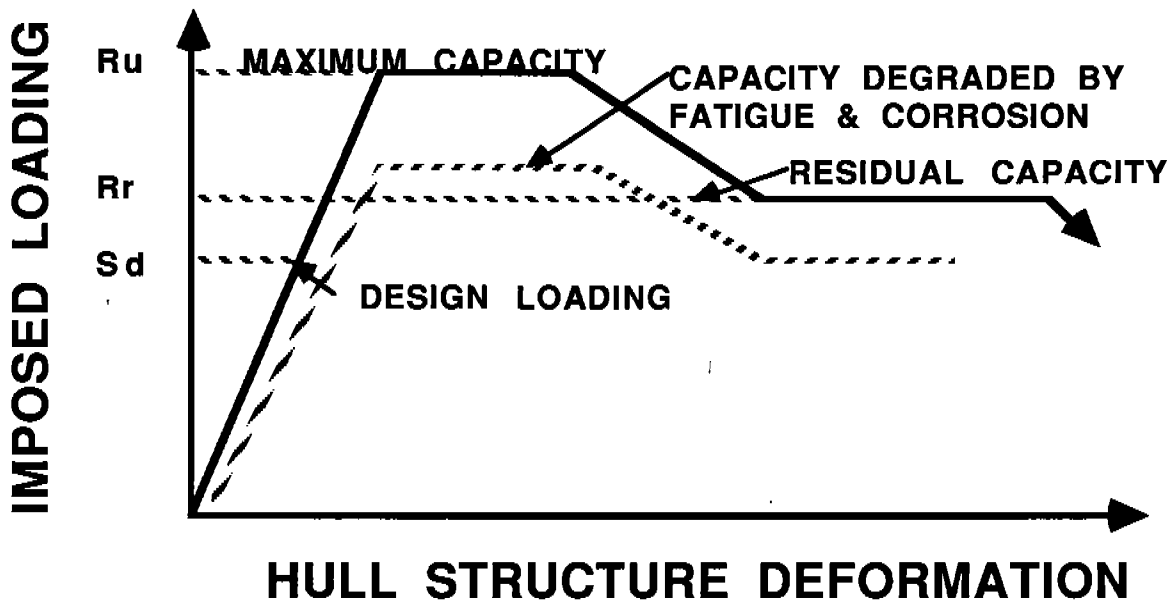


Figure 7.1 - Initial and Degraded Hull Structure Performance Characteristics

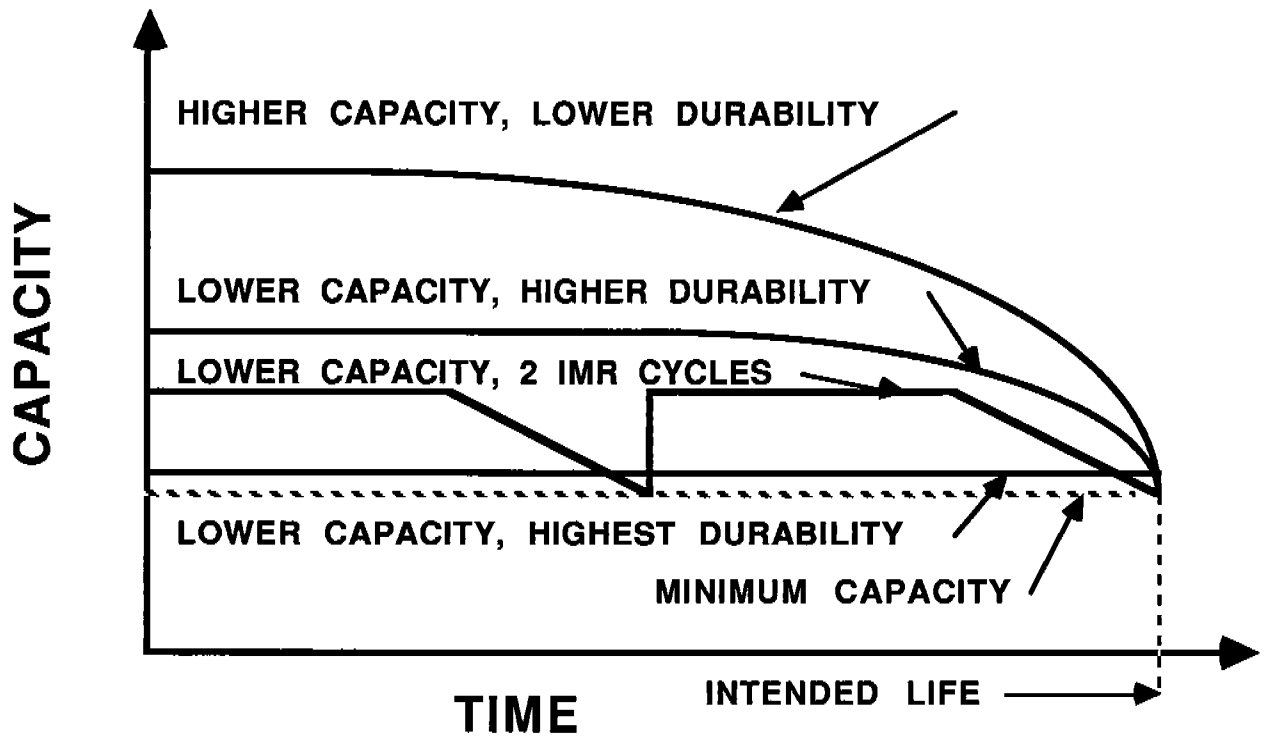


Figure 7.2 - Change in Hull Structure Capacities as a Function of Durability, IMR, and Time

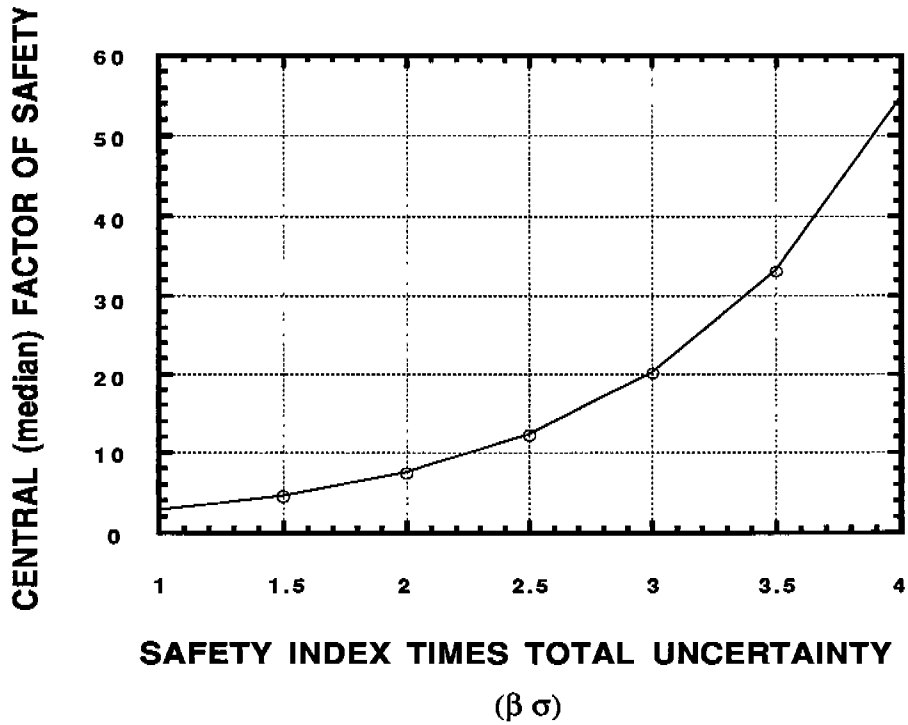


Figure 7.3 - Required Central Factor of Safety as a Function of Required Safety Index and Total Uncertainty in Hull Structure Loadings and Capacities

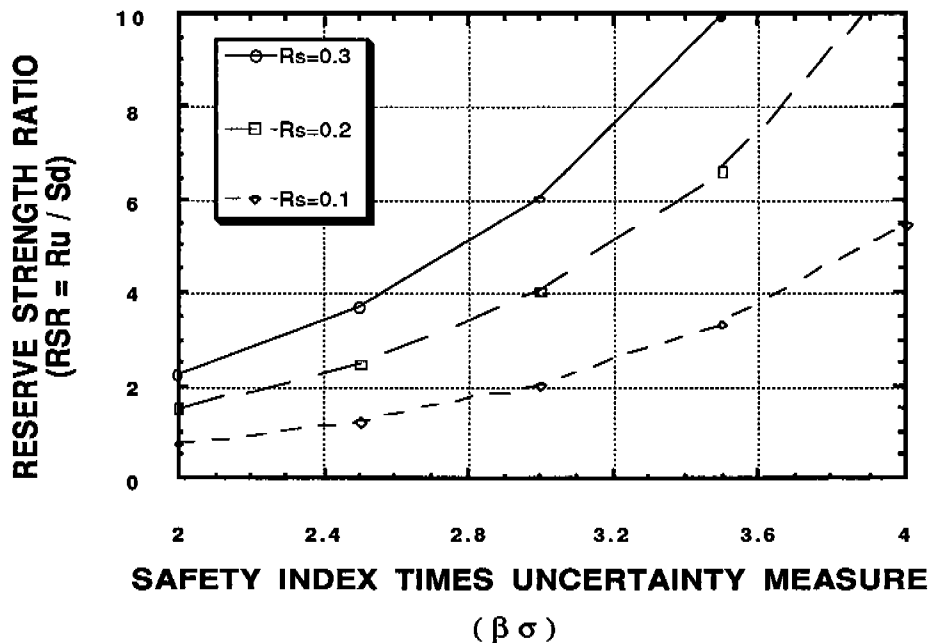
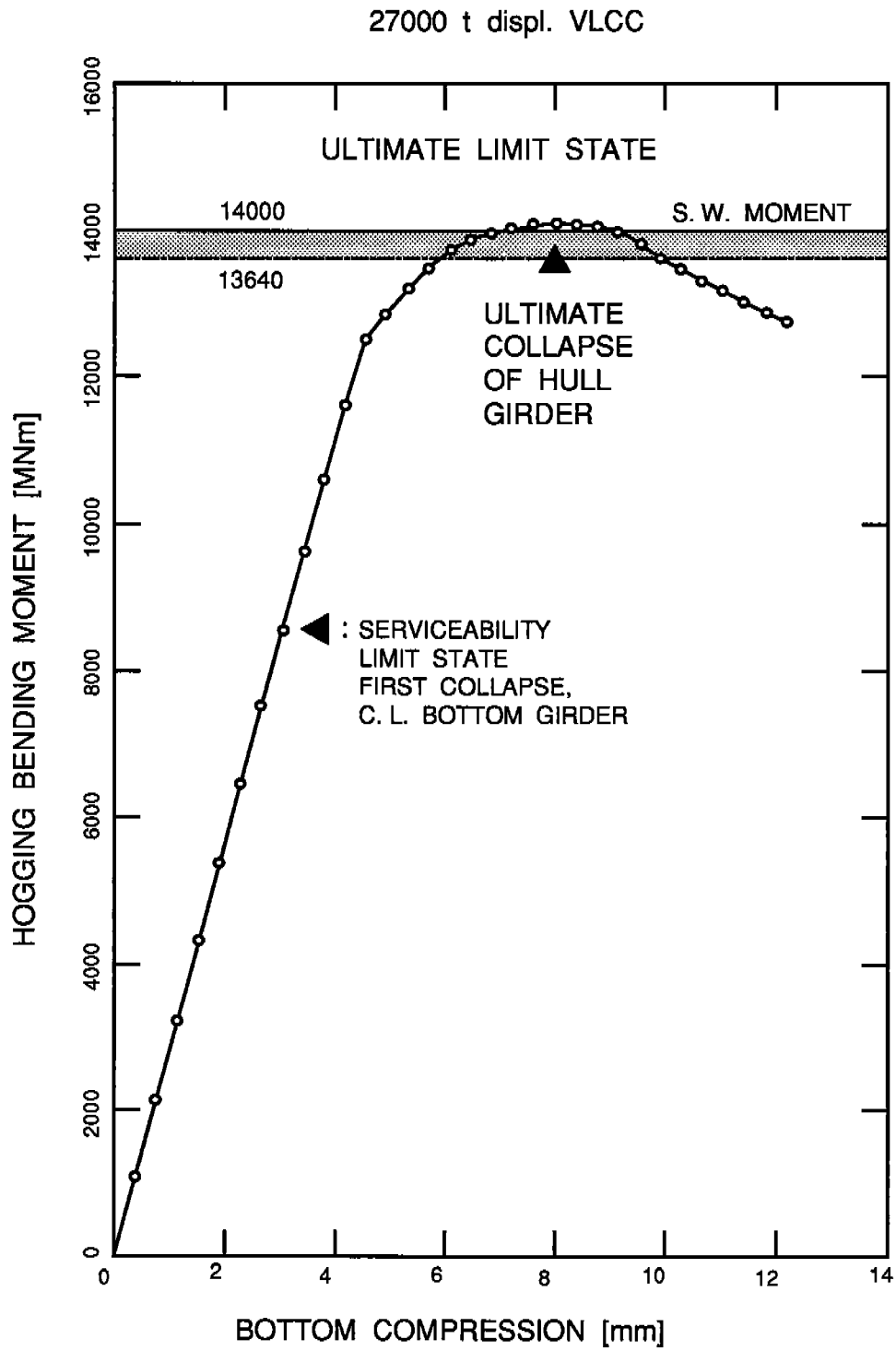
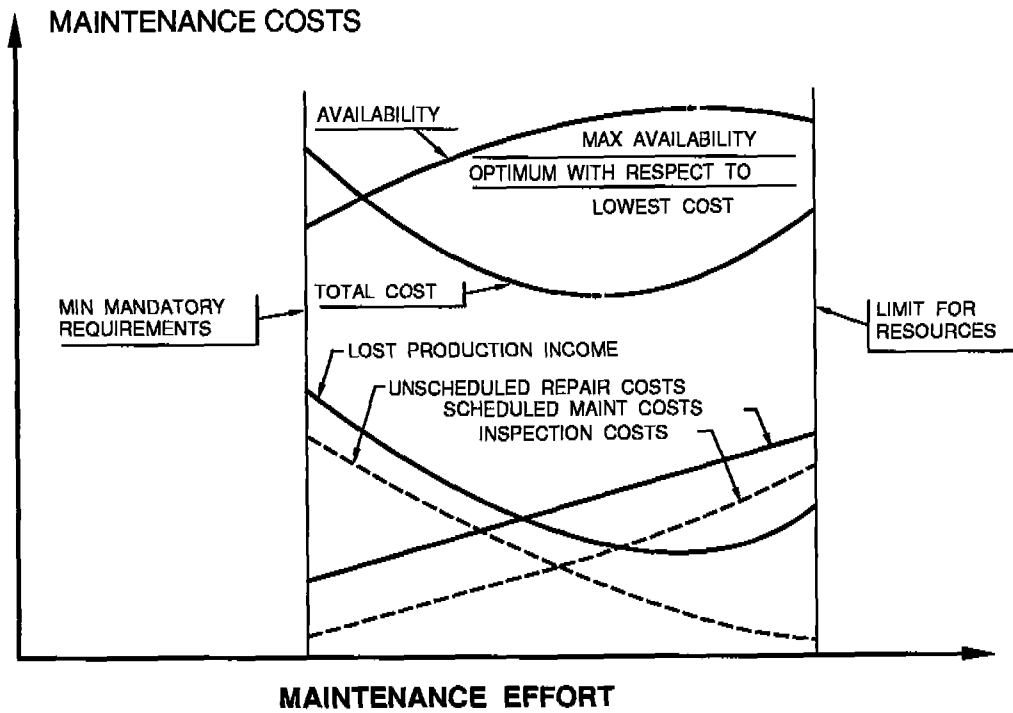


Figure 7.4 - Required Reserve Strength Ratio as a Function of Loading Ratios (median expected maximum loading / design loading)

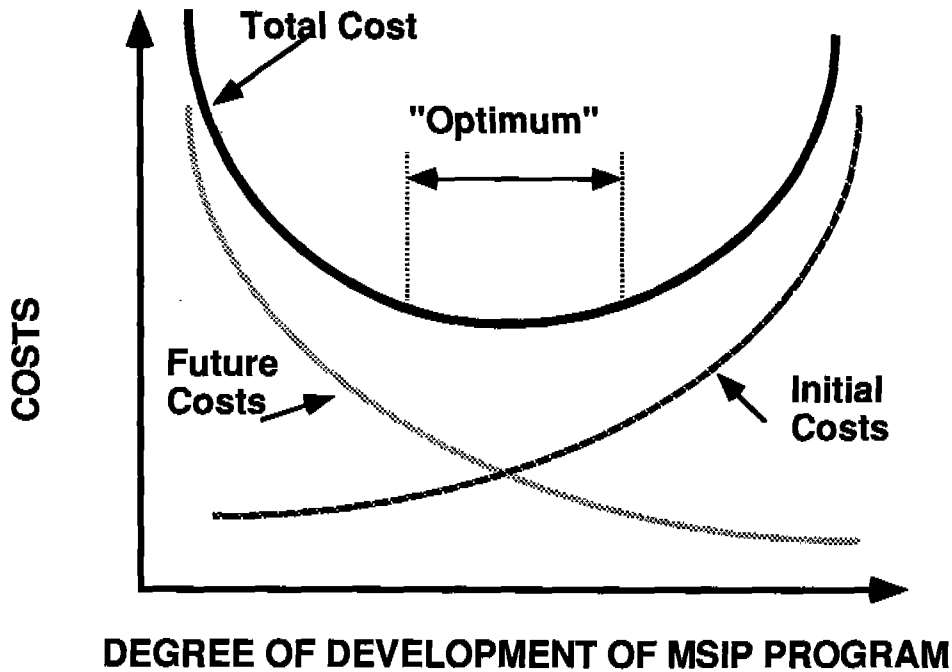


**Figure 15 - Tanker Hull Structure Serviceability and Ultimate Limit State Capacities**

21



**Figure 7.6 - Hull Structure Maintenance Cost - Benefit Evaluation**



**Figure 7.7 - Hull Structure MSIP Cost - Benefit Evaluation**

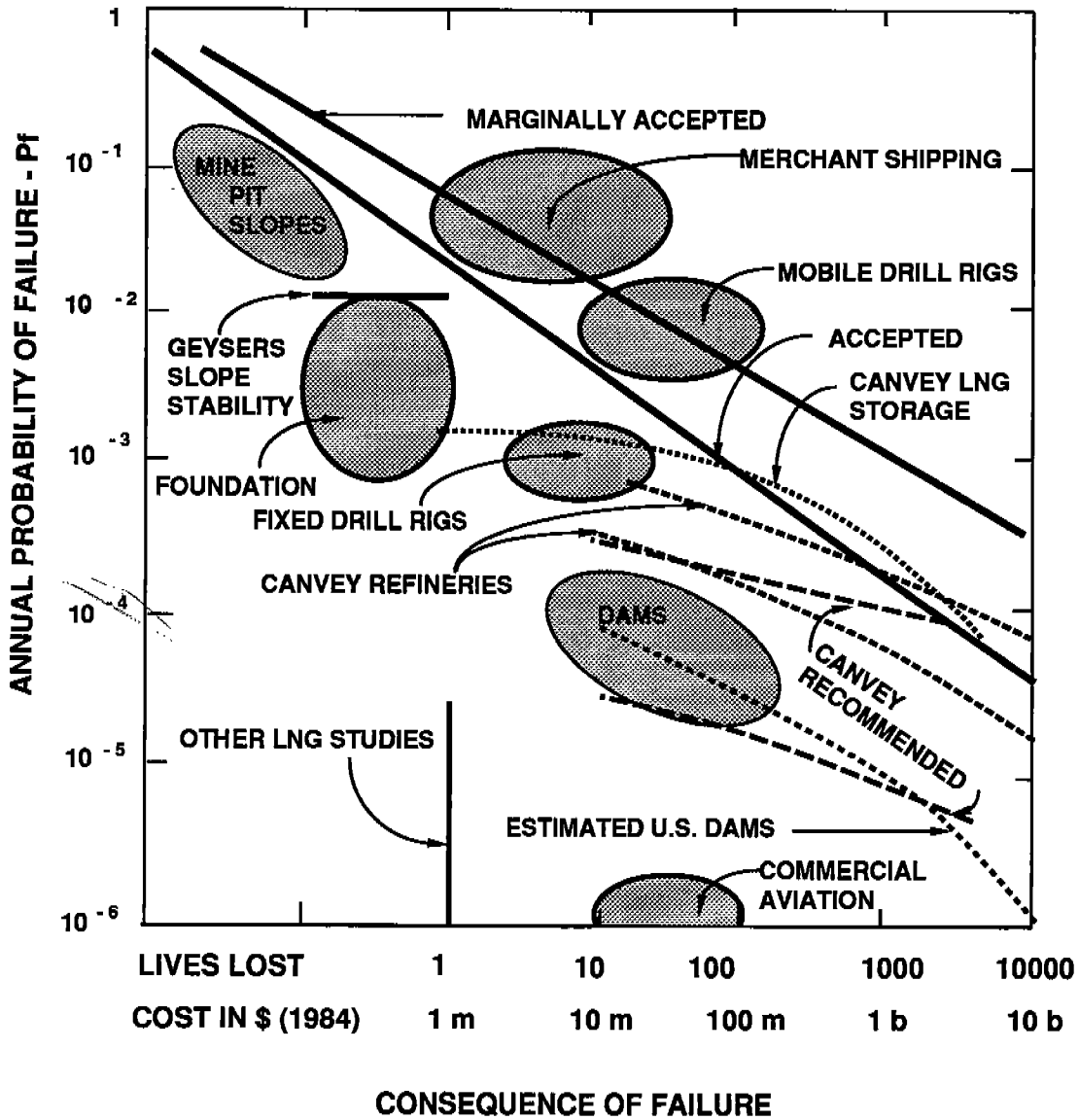
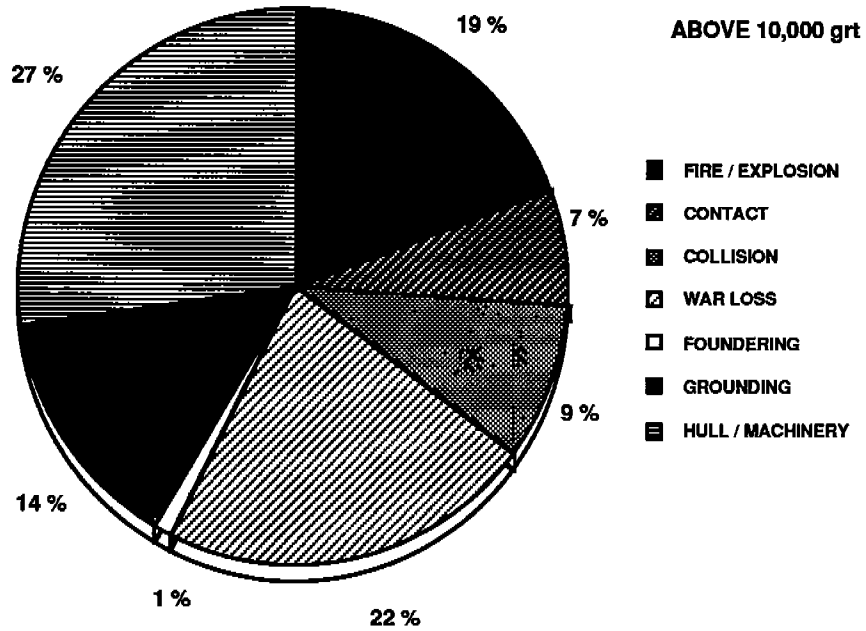
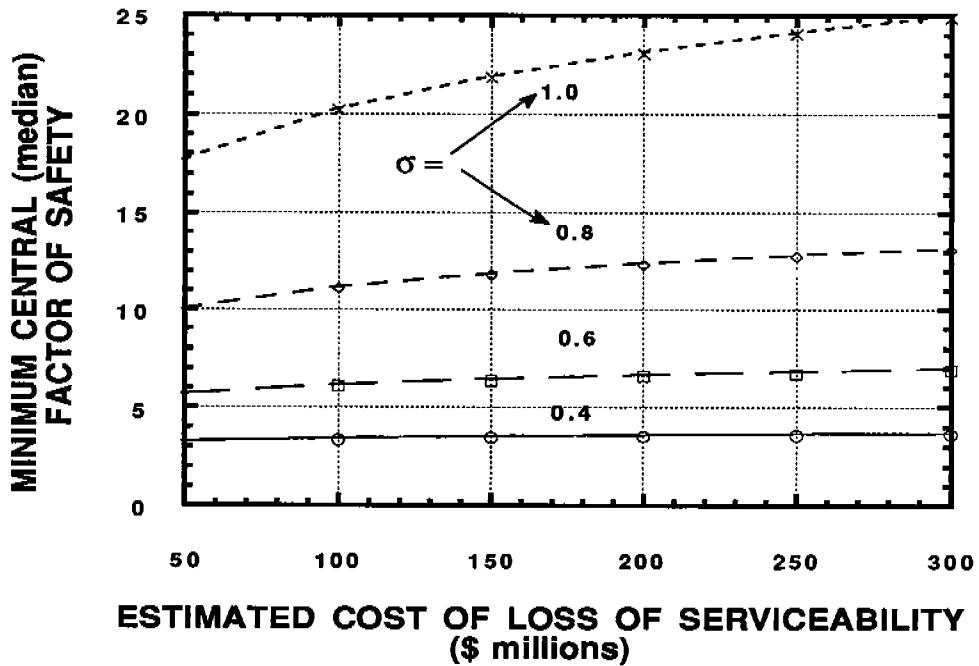


Figure 7.8 - Historic Data on Likelihoods and Consequences of Failures of Engineered Structures



**Figure 7.9 - Analysis of Tanker Casualties (Above 10,000 grt), 1979 - 1987**



**Figure 7.10 - Minimum Central Factor of Safety as a Function of the Estimated Costs Associated With Loss of Serviceability of the Ship Hull Structure**



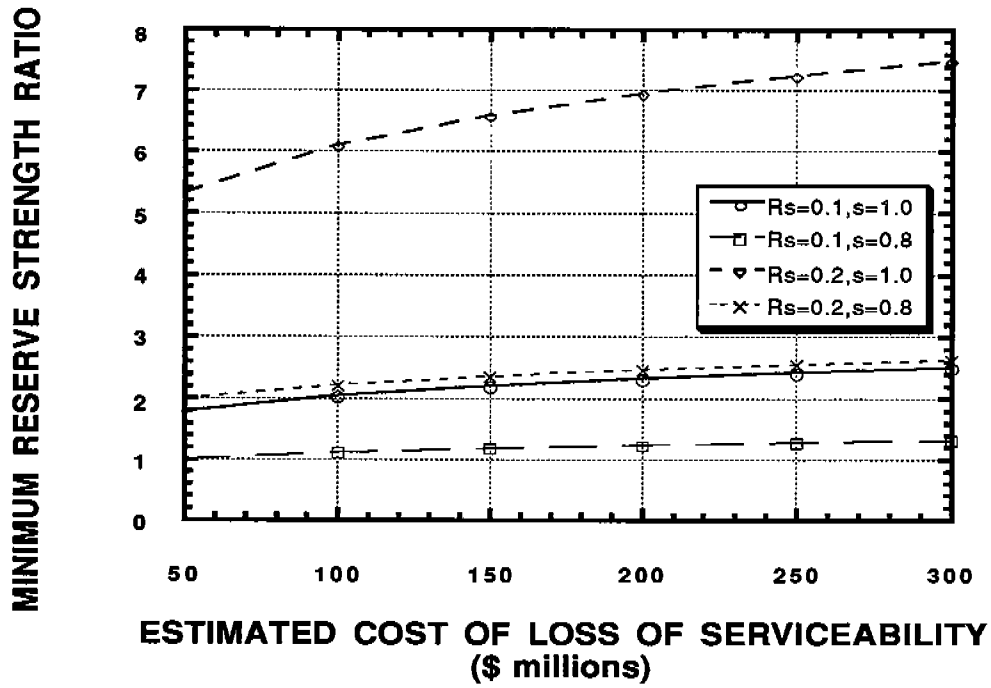


Figure 7.11 - Minimum Reserve Strength Ratio as a Function of the Estimated Costs Associated With Loss of Serviceability of the Ship Hull Structure

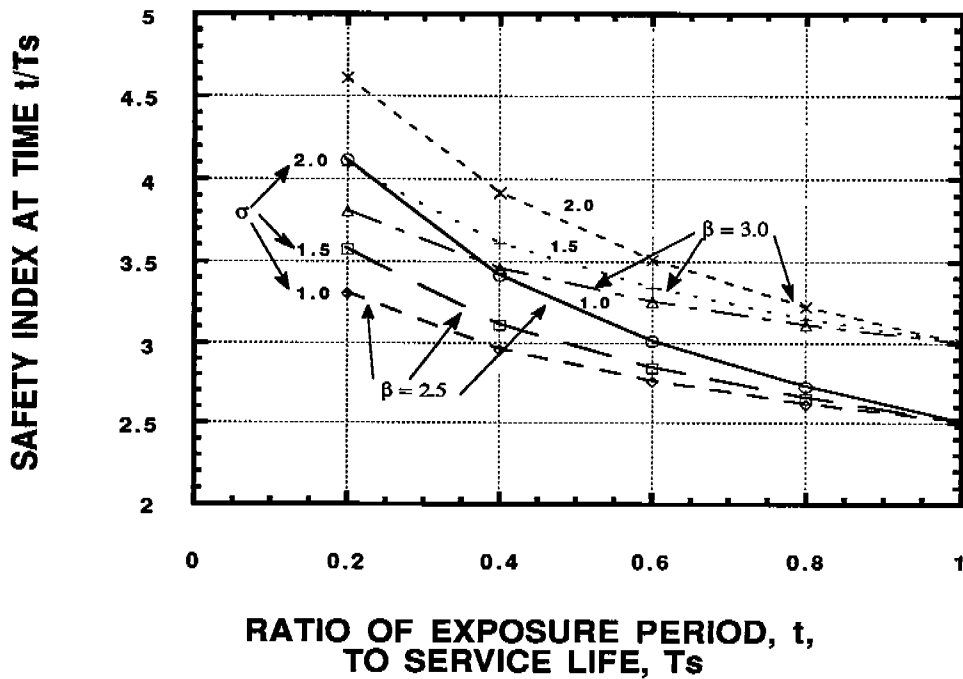


Figure 7.12 - Change in the Fatigue Safety Index as a Function of the Hull Structure Exposure Period and Service Life

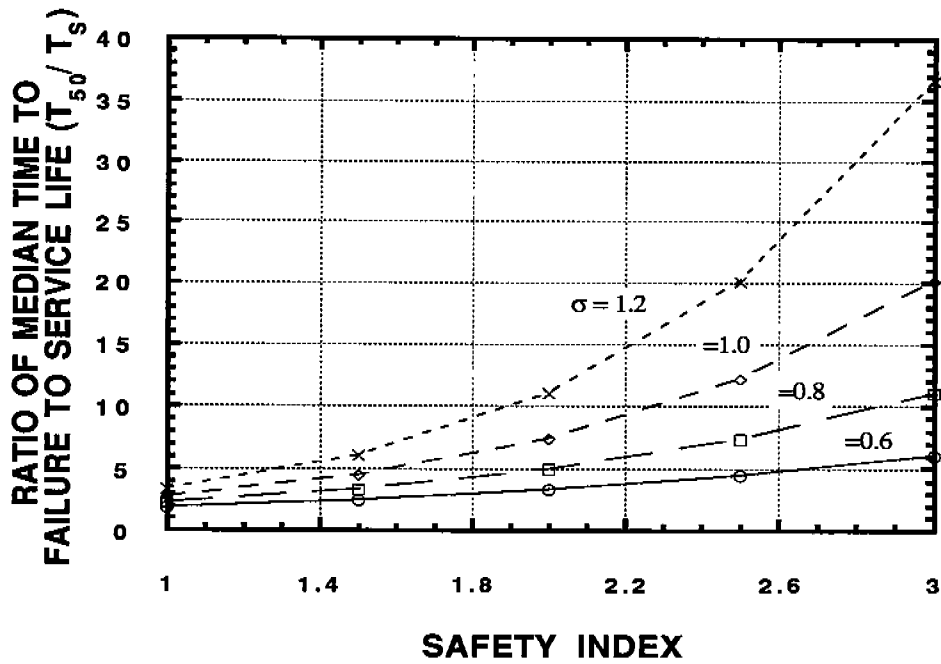


Figure 7.13 - Required Fatigue Design Factor of Safety as a Function of the Fatigue Design Safety Index and Total Uncertainties in Time to Failure

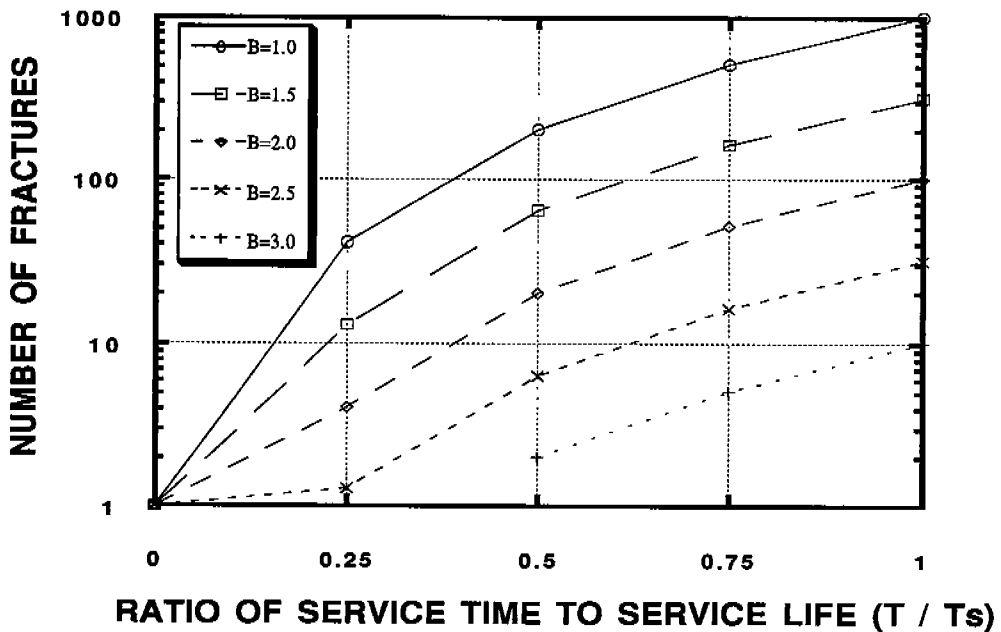
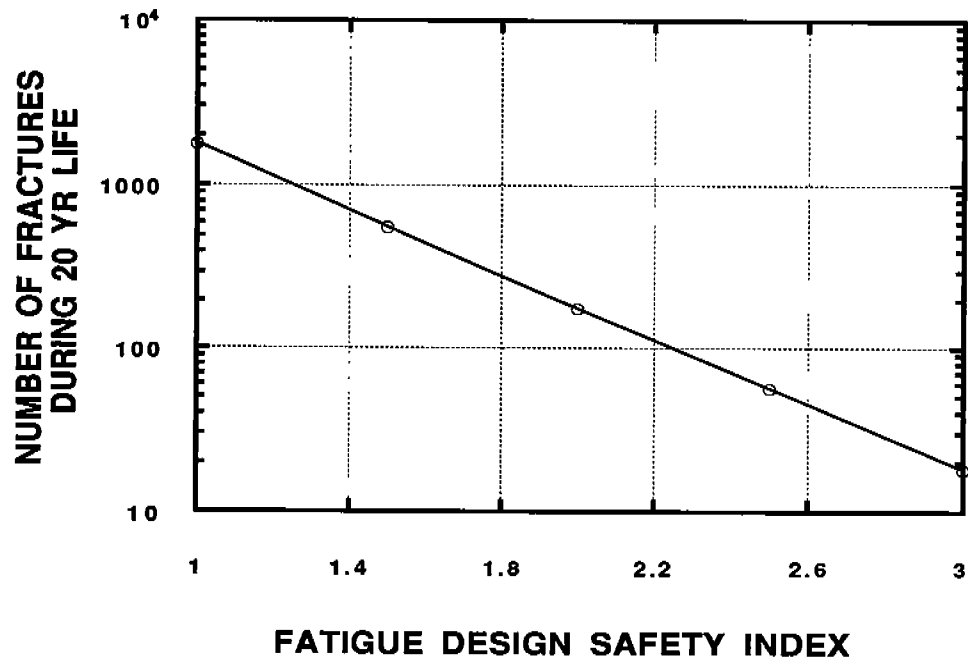
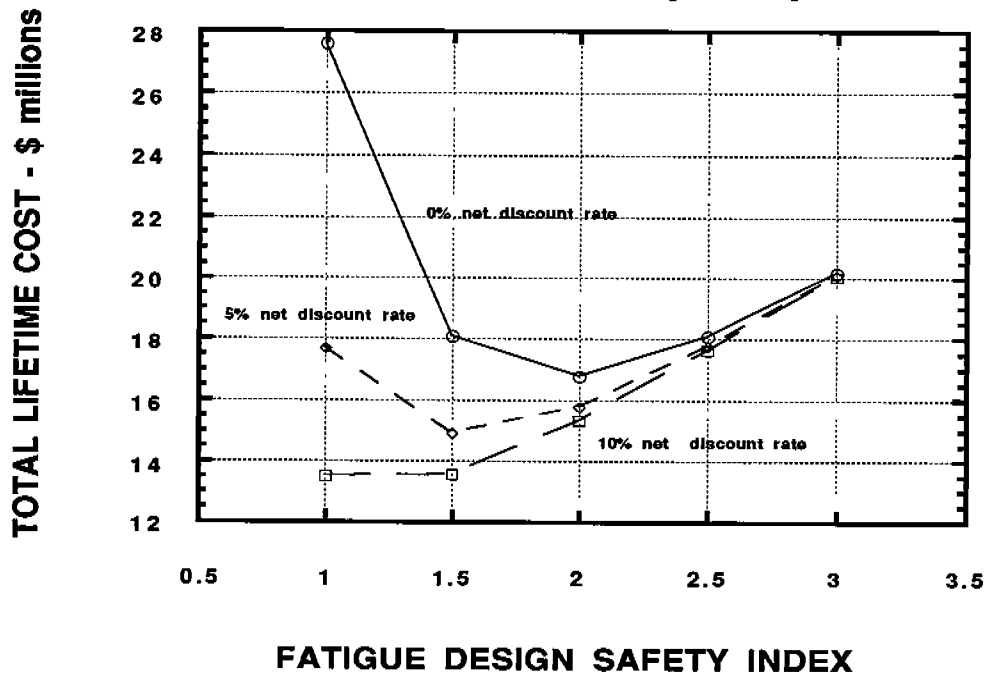


Figure 7.14 - Number of Fatigue Fractures in Example ULCC Hull Structure As Function of Time and Fatigue Design Safety Index



**Figure 7.15 - Total Number of Fatigue Fractures Expected in Example ULCC Hull Structure as a Function of the Fatigue Design Safety Index**



**Figure 7.16 - Total Lifetime (20-year) Costs in Example ULCC Hull Structure as a Function of the Fatigue Design Safety Index and Net Present Value Discount Rate**

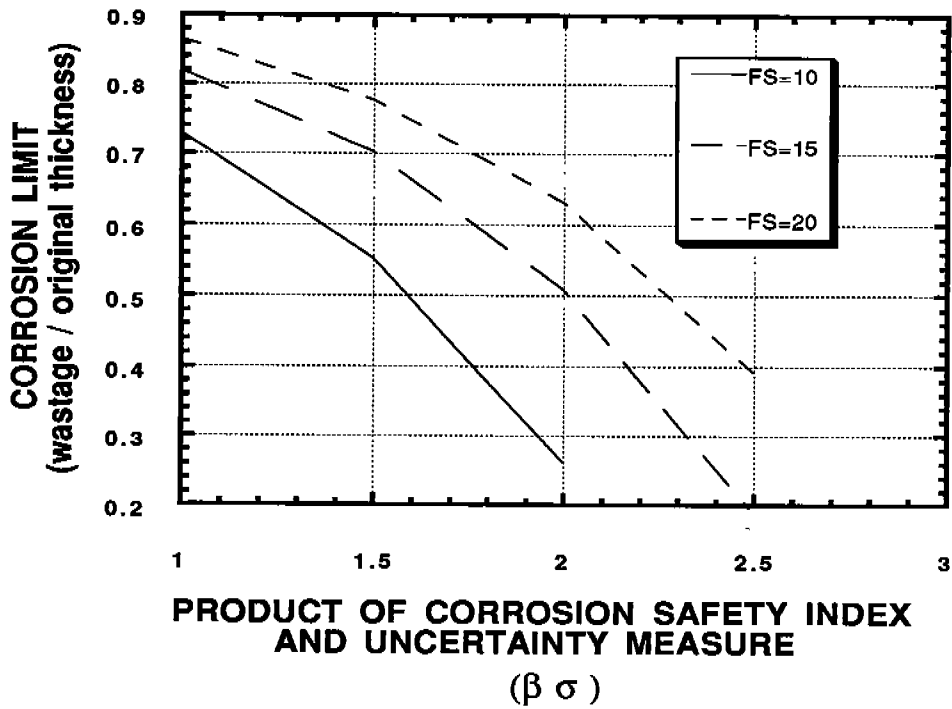


Figure 7.17 - Corrosion Limit as a Function of the Design Corrosion Safety Index and Total Uncertainty Measure (loadings, capacities, corrosion)

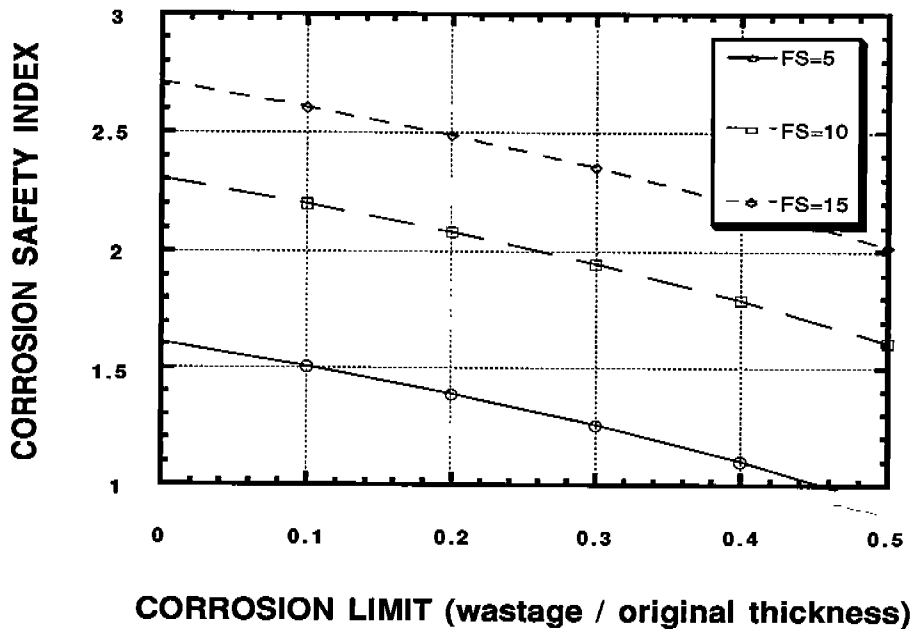


Figure 7.18 - Corrosion Limit as a Function of the Corrosion Safety Index and Initial Design Factor of Safety (FS)

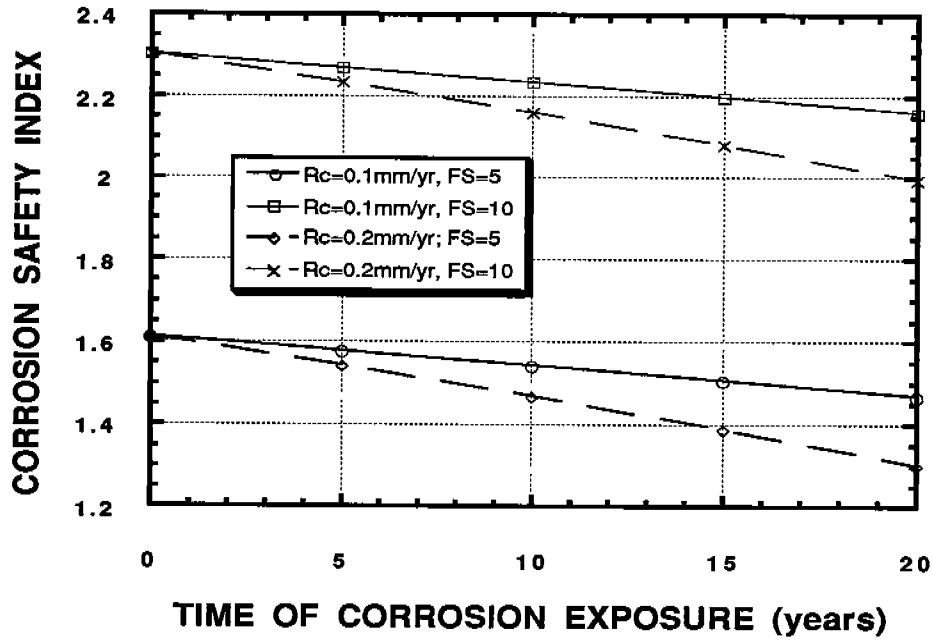


Figure 7.19 - Variation of Corrosion Safety Index as a Function of the Exposure Time, Average Corrosion Rate ( $R_c = 0.1 - 0.2$  mm/yr), and Initial Design Factor of Safety (FS)

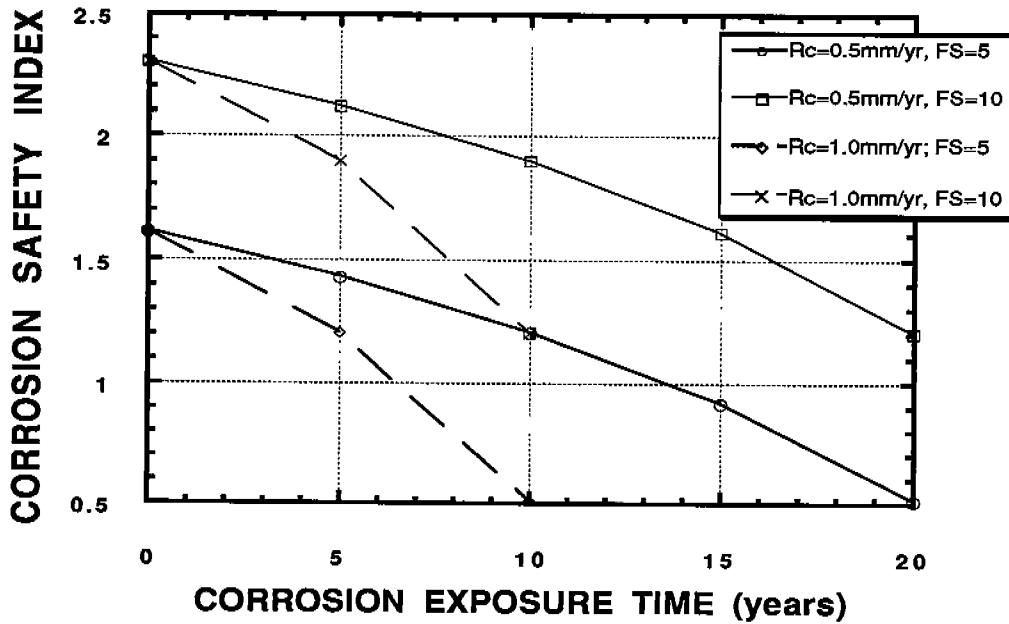


Figure 7.20 - Variation of Corrosion Safety Index as a Function of the Exposure Time, Average Corrosion Rate ( $R_c = 0.5 - 1.0$  mm/yr) and Initial Design Factor of Safety (FS)

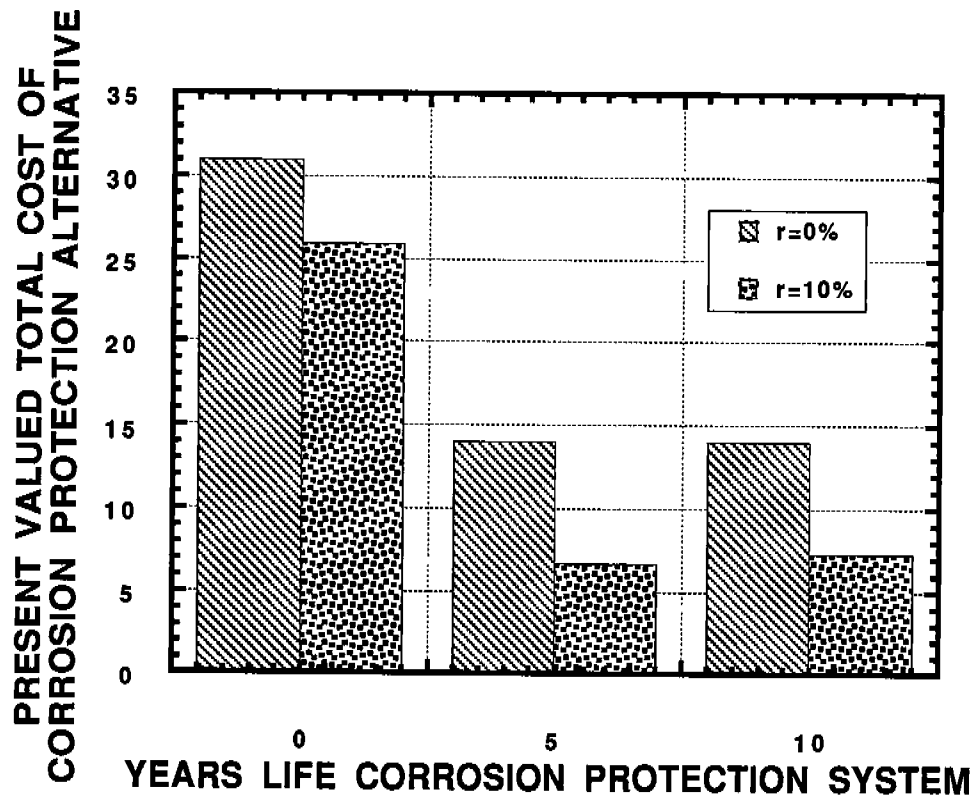


Figure 7.21 - Total Lifetime (20-year) Costs Associated With Three Alternative Corrosion Protection Systems

## FUTURE DEVELOPMENTS

### **Background**

---

**The objective of this chapter is to summarize recommendations of procedures and future research and development that should be conducted to allow implementation of advanced MSIP for VLCCs and ULCCs.**

The basic technology for implementation of an advanced MSIP for VLCCs and ULCCs exists. Developmental work is needed to allow this technology to be efficiently and effectively implemented. The primary challenge is applying the existing MSIP technology in a proper and timely manner.

The major impediments to implementation of an advanced MSIP are oriented in organizational and resource issues. The organizations involved in this industry need to agree that an advanced MSIP must be implemented. Industry organizations should cooperate in development and implementation of advanced MSIP. Resource sharing will help reduce the burden of and potentials for blunders in such developments. Positive incentives should be provided within the industry to encourage such developments and to discourage lack of implementation of such developments. Cooperation, trust, and integrity should permeate these developments.

The remainder of this chapter will summarize the key technical developments that are needed to allow advanced MSIP to become a reality.

### **Structural Design**

---

One major structural design development to allow implementation of an advanced MSIP was identified in Chapter 4:

- **Development and verification of definitive durability and damage tolerance engineering guidelines.**

Development of these guidelines and procedures can be based on existing technology. What is required is to reduce this technology to practical engineering terms and to verify that the developments are producing the desired results. Developmental work is needed to improve the following aspects:

- Design and testing for fatigue resistance - the implementation of first principle analysis and engineering methods to design CSD and the assembly of these elements into durable components and structural systems; the use of such methods to assess the needs for repairs, and to improve the durability of repairs. This will assure that fatigue resistance is brought into balance with strength and buckling resistance. Engineering and testing of CSD that will produce more durable structure systems need to be intensified and incorporated as a part of the normal process to assure adequate durability of the hull structure system.
- Design for corrosion resistance - the definition of practical element configurations, coating and cathodic protection systems that can be used to mitigate and reduce corrosion damage.
- Design for inspectability - definition of how hull structure design can be improved to facilitate high quality inspections during construction, during in-service periods, and during maintenance and repair periods; the use of design analyses to define high priority inspection and maintenance areas within the hull structure.
- Design for constructability - design of CSD, components, and assemblies of these components that can accommodate reasonable fabrication tolerances and procedures.
- Design for maintenance and repairability - configuration of the hull structure system and CSD to facilitate maintaining and repair operations.
- Design for damage tolerance - implementation of first principle analysis and engineering methods to assure that the ship hull structure possesses desirable levels of "robustness"; taking advantage of redundancy, ductility, and excess capacity in critical CSD and assemblies to assure that the hull structure is able to maintain its capacity, stability, and safety functions given high likelihood damage (e.g. from collisions and groundings) and high likelihood defects.



## Inspections, Maintenance, Repairs

One major IMR development to allow implementation of an advanced MSIP was identified in Chapter 5:

- **Development and verification of efficient and effective inspection and monitoring systems and performance guidelines for construction, in-service, and maintenance/repair periods.**

To allow significant progress in development of MSIP, the quality of inspections and monitoring must be improved. The low reliability (low likelihoods of detecting significant flaws and damage) in inspections must be paid for in present MSIP by incorporating larger factors of safety in the durability design and maintenance procedures. Inspections technology from other industries should be closely examined and the applicable elements adapted for the purposes of this industry. Developmental work is needed on the following aspects:

- **Access - improved physical systems to facilitate access of the inspection team and inspection equipment to the CSD within the hull structure.**
- **Instrumentation and monitoring- robust instrumentation and shipboard monitoring systems that are capable of detecting important exceedances of operating envelopes and important changes in the strength and durability characteristics of the ship hull structure are badly needed. Developments include improvements in inspection lighting and optical scanning systems, instrumentation to be able to detect significant cracks before they become critical, to detect that the CSD have been fitted and welded properly, to determine if corrosion protection systems are breaking down, and determine if corrosion has begun to have a significant effect on the strength and ductility of the CSD and hull structure system. Point source instruments capable of scanning only a very small area have been the focus of many past instrumentation developments; this focus needs to be shifted to instrumentation and monitoring systems that are capable of scanning much larger areas.**
- **Recording - robust recording systems that include improved photographic systems, electronic sketch and note pads, digital instrument recording systems, and digital voice translation and inspection systems. The recording systems need to be integrated with the general MSIP information and database systems.**
- **Procedures - definition of high priority CSD that should be inspected, the timing of such inspections, the equipment that should be**

utilized, and the methods that should be used to define how inspections are performed and their results recorded and evaluated.

---

**Information Systems**

---

One major information system development to allow implementation of an advanced MSIP was identified in Chapter 6:

- **Development and implementation of a computer based database MSIP information system.**

A major impediment to improving MSIP has been the lack of definitive historic information and data on which to base the need for improvements and to help focus how improvements might best be made. The wealth of experience that has been developed in this industry largely resides in the minds and files of the key individuals that are involved in the regulatory, classification, owner/operator, and builder/repair yard organizations. Only recently have any industry-wide efforts been initiated to improve data recording, archiving, retrieval, analysis, and evaluation. Developmental work is needed on the following aspects:

- Database, management, and analysis components need to be developed to incorporate information and data from MSIP plans, design, construction, operations, maintenance and repair, and inspection and monitoring life-cycle activities.
- Information and data recording systems need to be developed to facilitate input of information to the MSIP information system. Information and data evaluation and assessment systems need to be developed to facilitate communications and disseminate knowledge from the MSIP information system.
- Recent industry efforts to develop computer database components of an MSIP information system need to be encouraged and further developed.
- The FAA ASIP information system needs to be reviewed and evaluations made how this system might be adapted for the purposes of an equivalent USCG MSIP information system.

---

**Summary**

---

Three technical developments to allow implementation of an advanced MSIP have been identified during the course of this study. These developments are:

- **Development and verification of definitive durability and damage tolerance engineering guidelines.**
- **Development and verification of efficient and effective inspection and monitoring systems and performance guidelines for construction, in-service, and maintenance/repair periods.**
- **Development and implementation of a computer based database MSIP information system.**

*This Page Intentionally Left Blanks*

46626C3

COMMITTEE ON MARINE STRUCTURES

Commission on Engineering and Technical Systems

National Academy of Sciences - National Research Council

The COMMITTEE ON MARINE STRUCTURES has technical cognizance over the interagency Ship Structure Committee's research program.

Peter M. Palermo (Chairman), Alexandria, VA  
Mark Y. Berman, Amoco Production Company, Tulsa, OK  
Peter A. Gale, John J. McMullin Associates, Arlington, VA  
Rolf D. Glasfeld, General Dynamics Corporation, Groton, CT  
William H. Hartt, Florida Atlantic University, Boca Raton, FL  
Paul H. Wirsching, University of Arizona, Tucson, AZ  
Alexander B. Stavovy, National Research Council, Washington, DC  
Michael K. Parmelee, Ship Structure Committee, Washington, DC

LOADS WORK GROUP

Paul H. Wirsching (Chairman), University of Arizona, Tucson, AZ  
Subrata K. Chakrabarti, Chicago Bridge and Iron Company, Plainfield, IL  
Keith D. Hjelmstad, University of Illinois, Urbana, IL  
Hsien Yun Jan, Martech Incorporated, Neshanic Station, NJ  
Jack Y. K. Lou, Texas A & M University, College Station, TX  
Naresh Maniar, M. Rosenblatt & Son, Incorporated, New York, NY  
Solomon C. S. Yim, Oregon State University, Corvallis, OR

MATERIALS WORK GROUP

William H. Hartt (Chairman), Florida Atlantic University, Boca Raton, FL  
Fereshteh Ebrahimi, University of Florida, Gainesville, FL  
Santiago Ibarra, Jr., Amoco Corporation, Naperville, IL  
Paul A. Lagace, Massachusetts Institute of Technology, Cambridge, MA  
John Landes, University of Tennessee, Knoxville, TN  
Mamdouh M. Salama, Conoco Incorporated, Ponca City, OK  
James M. Sawhill, Jr., Newport News Shipbuilding, Newport News, VA

*Handwritten signature*

46626C4

SHIP STRUCTURE COMMITTEE PUBLICATIONS

- SSC-348 Corrosion Experience Data Requirements by Karl A. Stambaugh and John C. Knecht 1988
- SSC-349 Development of a Generalized Onboard Response Monitoring System (Phase I) by F. W. DeBord, Jr. and B. Hennessy 1987
- SSC-350 Ship Vibration Design Guide by Edward F. Noonan 1989
- SSC-351 An Introduction to Structural Reliability Theory by Alaa E. Mansour 1990
- SSC-352 Marine Structural Steel Toughness Data Bank by J. G. Kaufman and M. Prager 1990
- SSC-353 Analysis of Wave Characteristics in Extreme Seas by William H. Buckley 1989
- SSC-354 Structural Redundancy for Discrete and Continuous Systems by P. K. Das and J. F. Garside 1990
- SSC-355 Relation of Inspection Findings to Fatigue Reliability by M. Shinozuka 1989
- SSC-356 Fatigue Performance Under Multiaxial Load by Karl A. Stambaugh, Paul R. Van Mater, Jr., and William H. Munse 1990
- SSC-357 Carbon Equivalence and Weldability of Microalloyed Steels by C. D. Lundin, T. P. S. Gill, C. Y. P. Qiao, Y. Wang, and K. K. Kang 1990
- SSC-358 Structural Behavior After Fatigue by Brian N. Leis 1987
- SSC-359 Hydrodynamic Hull Damping (Phase I) by V. Ankudinov 1987
- SSC-360 Use of Fiber Reinforced Plastic in Marine Structures by Eric Greene 1990
- SSC-361 Hull Strapping of Ships by Nedret S. Basar and Roderick B. Hulla 1990
- SSC-362 Shipboard Wave Height Sensor by R. Atwater 1990
- SSC-363 Uncertainties in Stress Analysis on Marine Structures by E. Nikolaidis and P. Kaplan 1991
- SSC-364 Inelastic Deformation of Plate Panels by Eric Jennings, Kim Grubbs, Charles Zanis, and Louis Raymond 1991

*[Handwritten marks]*