

**SSC-446**

**COMPARATIVE STUDY OF SHIP  
STRUCTURE DESIGN STANDARDS**



This document has been approved  
For public release and sale; its  
Distribution is unlimited

**SHIP STRUCTURE COMMITTEE**  
**2007**

# Ship Structure Committee

RADM Craig E. Bone  
U. S. Coast Guard Assistant Commandant,  
Marine Safety and Environmental Protection  
Chairman, Ship Structure Committee

Mr. W. Thomas Packard  
Director,  
Survivability and Structural Integrity Group  
Naval Sea Systems Command

Dr. Roger Basu  
Senior Vice President  
American Bureau of Shipping

Mr. Joseph Byrne  
Director, Office of Ship Construction  
Maritime Administration

Mr. William Nash  
Director General, Marine Safety,  
Safety & Security  
Transport Canada

Mr. Kevin Baetsen  
Director of Engineering  
Military Sealift Command

Dr. Neil Pegg  
Group Leader - Structural Mechanics  
Defence Research & Development Canada - Atlantic

## **CONTRACTING OFFICER TECHNICAL REP.**

Mr. Chao Lin / MARAD  
Mr. Glenn Ashe / ABS  
DRDC / USCG

**EXECUTIVE DIRECTOR**  
Lieutenant Benjamin A. Gates  
U. S. Coast Guard

## **SHIP STRUCTURE SUB-COMMITTEE**

### **AMERICAN BUREAU OF SHIPPING**

Mr. Glenn Ashe  
Mr. Derek Novak  
Mr. Phil Rynn  
Mr. Balji Menon

### **DEFENCE RESEARCH & DEVELOPMENT CANADA ATLANTIC**

Dr. David Stredulinsky  
Mr. John Porter

### **MARITIME ADMINISTRATION**

Mr. Chao Lin  
Mr. Carl Setterstrom  
Mr. Richard Sonnenschein

### **MILITARY SEALIFT COMMAND**

Mr. Michael W. Touma  
Mr. James Kent  
Mr. Paul Handler

### **ONR / NAVY / NSWCCD**

Dr. Paul Hess  
Dr. Jeff Beach  
Dr. Yapa Rajapakse  
Mr. Allen H. Engle

### **TRANSPORT CANADA**

Mr. Richard Stillwell

### **US COAST GUARD**

Capt. Patrick Little  
Mr. H. Paul Cojeen  
Mr. Rubin Sheinberg

### **SOCIETY OF NAVAL ARCHITECTS AND MARINE ENGINEERS**

Mr. Jaideep Sirkar  
Mr. Al Rowen  
Mr. Norman Hammer

*Member Agencies:*

*American Bureau of Shipping  
Defence Research Development Canada  
Maritime Administration  
Military Sealift Command  
Naval Sea Systems Command  
Society of Naval Architects & Marine Engineers  
Transport Canada  
United States Coast Guard*



**Ship  
Structure  
Committee**

*Address Correspondence to:*

*Executive Director  
Ship Structure Committee  
U.S. Coast Guard (CG-3PSE/SSC)  
2100 Second Street, SW  
Washington, D.C. 20593-0001  
Web site: <http://www.shipstructure.org>*

**SSC – 446  
SR – 1444**

**MARCH 21, 2007**

**COMPARATIVE STUDY OF NAVAL AND COMMERCIAL SHIP STRUCTURE  
DESIGN STANDARDS**

The goal of any design standard is to ensure acceptable performance of the system for its intended operational lifespan. Classification Society rules continue to evolve and several nations have begun work with Classification Societies to develop rules for the construction of naval vessels. Meanwhile, extensive research is being conducted on various aspects of structural design that capitalize on recent technological advancements.

This study investigates the variety of rules and research currently available and evaluates the differences and commonalities to make recommendations for the development of future design standards.

A handwritten signature in black ink, appearing to read 'Craig E. Bone', written over a faint circular stamp or seal.

**CRAIG E. BONE**  
Rear Admiral, U.S. Coast Guard  
Chairman, Ship Structure Committee

*Technical Report Documentation Page*

1. Report No. <b>SSC - 446</b>		2. Government Accession No.		3. Recipient's Catalog No.	
4. Title and Subtitle Comparative Study of Naval and Commercial Ship Structure Design Standards				5. Report Date <b>May. 1, 2006</b>	
				6. Performing Organization Code <b>5813C.FR</b>	
7. Author(s) A. Kendrick, Dr. C. Daley				8. Performing Organization Report No. SR-1444	
9. Performing Organization Name and Address BMT Fleet Technology Ltd. 311 Legget Drive Kanata, ON (Canada) K2K 1Z8				10. Work Unit No. (TRAIS)	
				11. Contract or Grant No.	
12. Sponsoring Agency Name and Address Ship Structure Committee C/O Commandant (CG-3PSE/SSC) United States Coast Guard 2100 2 <sup>nd</sup> Street, SW Washington, DC 20593-0001				13. Type of Report Final Report	
				14. Sponsoring Agency Code CG - 3P	
15. Supplementary Notes Sponsored by the Ship Structure Committee and its member agencies					
<p><b>16. Abstract</b></p> <p>All design standards have the same goal, which is to ensure acceptable performance of the system under consideration. To accomplish this, all design standards must anticipate the relevant design challenges and set criteria that will ensure that all designs will exhibit acceptable in-service behaviors. In most situations involving ship structures, the design process has become one of satisfying the structural standard. The process of structural design is now largely eclipsed by efforts to comply with standards. In order to improve vessel designs in future, it must be acknowledged that it is crucial to have the best possible structural design standards, because the vessels can only be as good as the available standards.</p> <p>The primary objective of the project was to compare and evaluate the design criteria and standards currently used in naval and commercial ships for the hull and structural members. This report reviewed the basic concepts in several current ship and structures regulations. The design of bottom structure, as both local structure and as part of the hull girder was the specific focus. We expected to identify factors of safety in either the load or strength formulations or both.</p>					
17. Key Words			18. Distribution Statement Distribution Available From: National Technical Information Service U.S. Department of Commerce Springfield, VA 22151 Ph. (703) 605-6000		
19. Security Classif. (of this report)  Unclassified		20. Security Classif. (of this page)  Unclassified		21. No. of Pages	22. Price

**CONVERSION FACTORS**  
(Approximate conversions to metric measures)

<b>To convert from</b>	<b>to</b>	<b>Function</b>	<b>Value</b>
<b>LENGTH</b>			
inches	meters	divide	39.3701
inches	millimeters	multiply by	25.4000
feet	meters	divide by	3.2808
<b>VOLUME</b>			
cubic feet	cubic meters	divide by	35.3149
cubic inches	cubic meters	divide by	61.024
<b>SECTION MODULUS</b>			
inches <sup>2</sup> feet <sup>2</sup>	centimeters <sup>2</sup> meters <sup>2</sup>	multiply by	1.9665
inches <sup>2</sup> feet <sup>2</sup>	centimeters <sup>3</sup>	multiply by	196.6448
inches <sup>4</sup>	centimeters <sup>3</sup>	multiply by	16.3871
<b>MOMENT OF INERTIA</b>			
inches <sup>2</sup> feet <sup>2</sup>	centimeters <sup>2</sup> meters	divide by	1.6684
inches <sup>2</sup> feet <sup>2</sup>	centimeters <sup>4</sup>	multiply by	5993.73
inches <sup>4</sup>	centimeters <sup>4</sup>	multiply by	41.623
<b>FORCE OR MASS</b>			
long tons	tonne	multiply by	1.0160
long tons	kilograms	multiply by	1016.047
pounds	tonnes	divide by	2204.62
pounds	kilograms	divide by	2.2046
pounds	Newtons	multiply by	4.4482
<b>PRESSURE OR STRESS</b>			
pounds/inch <sup>2</sup>	Newtons/meter <sup>2</sup> (Pascals)	multiply by	6894.757
kilo pounds/inch <sup>2</sup>	mega Newtons/meter <sup>2</sup> (mega Pascals)	multiply by	6.8947
<b>BENDING OR TORQUE</b>			
foot tons	meter tons	divide by	3.2291
foot pounds	kilogram meters	divide by	7.23285
foot pounds	Newton meters	multiply by	1.35582
<b>ENERGY</b>			
foot pounds	Joules	multiply by	1.355826
<b>STRESS INTENSITY</b>			
kilo pound/inch <sup>2</sup> inch <sup>1/2</sup> (ksi√in)	mega Newton MNm <sup>3/2</sup>	multiply by	1.0998
<b>J-INTEGRAL</b>			
kilo pound/inch	Joules/mm <sup>2</sup>	multiply by	0.1753
kilo pound/inch	kilo Joules/m <sup>2</sup>	multiply by	175.3

## TABLE OF CONTENTS

1.	INTRODUCTION .....	1
1.1	General .....	1
1.2	Background .....	1
1.2.1	“Traditional” Ship Structural Design Standards .....	1
1.2.2	Recent Structural Standards Development .....	3
1.3	Discussion of Structural Standards Development .....	6
2.	REVIEW OF DESIGN STANDARDS .....	8
2.1	Summary .....	8
2.2	Overview of Structural Design Rules .....	9
2.3	Rule Features .....	11
2.4	Rule Comparison .....	13
3.	REVIEW OF EXPERIMENTAL AND NUMERICAL DATA .....	16
3.1	Overview .....	16
4.	QUALITATIVE COMPARISON OF THE RULES .....	21
4.1	Introduction .....	21
4.2	Current Commercial Ship Rules .....	22
4.2.1	DnV Plating Requirements .....	22
4.2.2	DnV Framing and Hull Girder Requirements .....	25
4.2.3	DnV Combined Stress Results .....	27
4.2.4	Qualitative Comparison of DnV, JBR and JTR Requirements .....	29
4.2.5	Quantitative Comparison of DnV with ABS Container Ship Requirements ..	31
4.2.6	Comparison of Combined Stress value in DnV, JBR, JTR and ABS Container Ship Requirements .....	32
4.3	LRFD Ship Rules .....	36
4.3.1	Quantitative Comparison between DnV Rules and BV Rules .....	37
4.4	Hull Girder Stresses .....	38
4.5	Polar Class Rules .....	42
5.	COMPARISON AND ANALYSIS .....	45
5.1	Concept Comparison .....	45
5.1.1	Wave Pressures .....	45
5.1.2	Minima 50 .....	45
5.1.3	Corrosion Additions .....	53
5.1.4	Hull Girder Requirements .....	55
5.1.5	Rule Simplicity .....	56
5.2	Detailed Analysis .....	57
5.2.1	General cargo carriers under 90m in length .....	57
5.2.2	General Cargo Carriers over 90m in Length .....	63
5.2.3	Bulk Carriers over 150m in Length .....	67
5.2.4	Tankers over 150m in Length .....	69
5.2.5	Summary .....	71

---

5.3	Finite Element assessment .....	71
5.3.1	Plate Capacity .....	71
5.3.2	Frame Capacity .....	74
5.3.3	Discussion .....	75
6.	FUTURE DEVELOPMENT OF UNIFIED STANDARDS .....	77
6.1	Underlying Principles .....	77
6.1.1	Transparency in Standards .....	77
6.1.2	Modularity .....	78
6.1.3	Complexity .....	79
6.1.4	Consistency .....	79
6.2	Necessary Features .....	80
6.2.1	Idealization Approach .....	80
6.2.2	Load Definition .....	80
6.2.3	Response Definition .....	81
6.2.4	Factors of Safety .....	81
7.	CONCLUSIONS .....	83
8.	REFERENCES .....	84
9.	BIBLIOGRAPHY .....	86

## LIST OF FIGURES

Figure 2.1: Components of Rule-Based Ship Structural Design .....	10
Figure 4.1. Plate Behaviour Diagrams .....	23
Figure 4.2: Locations to Check Stress Combinations .....	27
Figure 4.3: Stress Superposition (Longitudinal Frame Case) .....	28
Figure 4.4: Von-Mises Stress Calculations (Cases in Table 4.2). .....	29
Figure 4.5: Von-Mises Combined Stress Calculations (Cases in Table 4.5 and 4.6). .....	34
Figure 4.6: Adjusted Von-Mises Stress Calculations (cases in Table 4.6). .....	36
Figure 4.7: IACS Design Wave Bending Moments and Return Periods (see Nitta et. al. 1992) .....	39
Figure 4.8: Comparison of Design Wave Heights .....	40
Figure 4.9: Simple Wave Bending Moment Calculation Concept .....	40
Figure 4.10: Bending (a) and Shear (b) Limit States Checked in UR I2 .....	42
Figure 5.1: JTR Wave Pressures .....	46
Figure 5.2: JBP Wave Pressures .....	46
Figure 5.3: BV Wave Pressures .....	47
Figure 5.4: ABS Rules for Oil Carriers over 150m Wave Pressures .....	48
Figure 5.5: Bottom Plating, DnV Rules .....	51
Figure 5.6: Members for which Common Corrosion Addition will be Applied (JTR and JBP) .....	54
Figure 5.7: Cross-section Weights, General Cargo Carriers under 90m .....	60
Figure 5.8: Cross-section Weights General Cargo Carriers under 90m as Function of Ship Length .....	61
Figure 5.9: Cross-section Weights as Function of Aspect Ratio .....	62
Figure 5.10: Cross-section Weight with Transverse Framing .....	62
Figure 5.11: Cross-section Weights for Larger General Cargo Carriers .....	65
Figure 5.12: Cross-section Weights Larger General Cargo Carriers as Function of Ship Length .....	66
Figure 5.13: Cross-section Weight for Bulk Carriers as Function of Ship Length .....	68
Figure 5.14: Cross-section Weights for Tankers as Function of Ship Length .....	70
Figure 5.15: Plate Finite Element Model .....	72
Figure 5.16: Plastic Capacity Comparison for DnV Bottom Plating .....	73
Figure 5.17: Plastic Capacity Comparison for DnV Bottom Plating .....	73
Figure 5.18: Grillage for Finite Element Analysis .....	74
Figure 5.19: Load vs. Lateral Deflection of the Grillage .....	75
Figure 5.20: Plastic Strain at 3 Load Levels for the Bottom Grillage .....	76
Figure 5.21: Plastic Capacity Comparison for DnV Bottom Plating .....	76
Figure 5.22: Plastic Capacity Comparison for DnV Bottom Plating .....	76



## LIST OF TABLES

Table 2.1: List of Rules Reviewed.....	8
Table 2.1: Rule Features Found in Most Structural Standards .....	11
Table 2.2: Examples of Rule Features (IACS Joint Tanker Rules).....	12
Table 2.4: Comparison of Approaches for Scantling Requirements .....	13
Table 2.5: Examples of Types of Scantling Requirements.....	15
Table 3.3: Experimental and Numerical Reference Data. ....	17
Table 4.1: Plate Response Equations.....	23
Table 4.2: Calculated Combined Stresses for DnV Commercial Rules .....	28
Table 4.3: Commercial Rules Design Criteria for Bottom Structure Plating .....	30
Table 4.4: Commercial Rules Design Criteria for Bottom Structure Ordinary Framing.....	31
Table 4.5: Combined Stresses at the Locations Shown in Figure 4.2 for DnV, JBR, JTR and ABS.....	33
Table 4.6: Adjusted Combined stresses at the locations shown in Figure 4.6 for DNV, JBR, JTR and BV.....	35
Table 4.7: Combined Stresses at the Locations Shown in Figure 4.2 for BV .....	37
Table 4.8: Extract from IACS UR I2 – Structural Rules for Polar Ships .....	43
Table 5.1: Wave Pressure Calculations .....	49
Table 5.1: Wave Pressure Calculations (continued).....	50
Table 5.2: Comparison of Minima.....	52
Table 5.3: Correlation between Minimum and Normal Scantling Requirements .....	52
Table 5.4: Comparison of Corrosion Additions.....	53
Table 5.5: Permissible Still Water Bending Moment; Different Rule Sets .....	55
Table 5.6: Ultimate Hull Girder Bending Capacity – Different Rule Sets .....	55
Table 5.7: Rule Simplicity Comparison.....	56
Table 5.8: Small General Cargo Ships.....	57
Table 5.9: Larger General Cargo Ships .....	63
Table 5.10: Bulk Carriers.....	67
Table 5.11: Tankers .....	69
Table 5.12: Calculated Bottom Plate Capacity for DnV Commercial Rules (700x2100x15pl).....	73

## LIST OF ABBREVIATIONS AND SYMBOLS

ABS	American Bureau of Shipping
ANA	Analytical
ASTM	American Society for Testing and Materials
BV	Bureau Veritas
CCS	China Classification Society
CNK	ClassNK, Classification Society of Japan (Nippon Kaiji Kyokai)
CSA	Canadian Standards Association
DnV	Det Norske Veritas
EXP	Experimental
FEA	Finite Element Analysis
FPSO	Floating, Production, Storage and Offloading
FSA	Formal Safety Assessment
GL	Germanischer Lloyd
IACS	International Association of Classification Societies
ILLC	International Load Line Convention
IMO	International Maritime Organization
ISO	International Standards of Operation
JBR	Joint Bulker Rules
JTR	Joint Tanker Rules
KR	Korean Register of Shipping
LR	Lloyd's Register
LRFD	Load and Resistance Factor Design
LS	Limit States
MARAD	U.S. Maritime Administration
MARPOL	Marine Pollution
NAVSEA	Naval Sea Systems Command
NSR	Naval Ship Rules
NUM	Numerical
OHBDC	Ontario Highway Bridge Design Code
PBS	Performance-Based Standards
PTC	Project Technical Committee
RINA	Royal Institution of Naval Architects
RS	Russian Maritime Register of Shipping
SOLAS	Safety of Lives at Sea
SSC	Ship Structures Committee
UK	United Kingdom
UR	Unified Requirements
US	United States
USN	United States Navy

# 1. INTRODUCTION

## 1.1 General

This project has been undertaken on behalf of the inter-agency Ship Structures Committee (SSC) through a contract let by the U.S. Maritime Administration (MARAD), and overseen by a Project Technical Committee (PTC) comprising representatives from various organizations and individuals in the U.S.A and Canada.

The stated primary objective of the project has been:

*“... to compare and evaluate the design criteria and standards currently used in naval and commercial ships for the hull and structural members.”*

The expectation is that such an assessment will be of benefit in identifying ‘best practices’ that incorporate latest models of structural behaviour and that are adequately validated by theory and experimentation. These best practices could then be applied to new designs and to in-service assessments of existing ships; either on a ship-specific basis or through the development of new, unified structural design criteria. The project is intended to address these broader objectives.

## 1.2 Background

The desire to develop more rational approaches to ship structural design is not new. The foreword to ‘A Guide for the Analysis of Ship Structures’ published in 1960, starts:

*"It has been the dream of every ship designer to rise above the conventional empirical methods of structural design and create a ship structural design based on rational methods."<sup>1</sup>*

In order to understand the need for a unified and rational approach to ship structure design, it is necessary to review the history and nature of current methods, and of alternatives to these.

### 1.2.1 “Traditional” Ship Structural Design Standards

The origins of most current commercial and naval ship structural design approaches can be found in the work of a number of mid-19<sup>th</sup> century pioneers, including Rankine, Smith and Reed. They developed methods of estimating hull girder bending loads due to waves, and also developed response criteria for bending and shear. Early iron-framed ships tended to have wooden decks and hulls, meaning that buckling did not become an issue. Formal approaches to buckling date from the 1940s to 1960s, and material property issues (notch toughness, weldability) started to be addressed systematically within the same timeframe, partly through the early work of the SSC on fatigue and fracture. One hundred and fifty years of research and development, cross-fertilized by efforts in other engineering disciplines have been incorporated in commercial and naval ship design standards in somewhat different ways.

---

<sup>1</sup> MacCutcheon, E.M. et al, “A Guide for the Analysis of Ship Structures”, National Academy of Sciences PB-181 168, produced in collaboration with the SSC.

Most commercial ships are constructed under the Rules of a Classification Society, such as the American Bureau of Shipping (ABS), Det Norske Veritas (DnV), Lloyds Register (LR), Bureau Veritas (BV), Germanischer Lloyd (GL), etc. These and other classification societies developed, starting in the 19<sup>th</sup> Century, in order to meet the growing needs of both governments and commercial interests to ensure that ships were adequately reliable and safe. Initially, they largely focused on national interests and fleets (or imperial, in the case of LR and BV); and most were whole or semi-government controlled. More recently, the market for ship classification services has become international in nature (in most cases) and so the classification societies have become more independent of national ties. However, most classification societies retain strong links with maritime administrations in their home countries.

In keeping with their origins, classification society rules developed in some level of isolation from each other for many years, meaning that (for example) ABS, DnV and LR requirements for different areas of design were presented in very different ways and could lead to significantly different outcomes in terms of scantlings. As technologies developed (new ship types, faster operating speeds, replacement of rivets by welding), rules governing their use were introduced into the various Rules, extending their scope.

Advances in analytical methodologies have also been incorporated as they have been developed. For example, prior to the work of Rankine and others noted above, LR's rule scantlings were proportional only to displacement, which led to decreasing factors of safety for larger ships. Subsequently, the rules were modified to incorporate a more systematic treatment of wave bending. Similarly, local strength and stability rule requirements were initially based on successful past practice and "rules of thumb"; and modified as the state-of-the-art expanded. However, some of the historical features were retained, making the rule systems a mixed bag of analytical and prescriptive requirements.

The differences in Rules systems, and organizational issues that influenced their application, led to differences in outcomes in terms of safety and reliability. Accordingly, a group of the leading Classification Societies formed the International Association of Classification Societies (IACS) in 1968. Some of the roles of IACS relevant to the current project are outlined in Section 1.2.

Naval vessel structural design requirements have evolved along parallel paths to commercial rules, but with differences in approach. Considerable emphasis has been given by classification societies to making their rules simple to understand and to apply. Standardized cases and approaches have been used wherever possible. Naval ship designers have been more accustomed to application-specific methods for load cases in particular. Similar response formulations are incorporated in most naval and commercial standards, although there have been some naval-specific load cases with unusual response modes (e.g., blast and shock).

In recent years, navy organizations in the US, Canada, and the UK have come under increasing resource constraints, making it more difficult for them to maintain their in-house structural (and other) design criteria. There has thus been a move to delegate responsibility for standards development to the classification societies, as discussed below.

## 1.2.2 Recent Structural Standards Development

### 1.2.2.1 *Current Marine Practice*

As noted previously, some recent convergence in classification society rule systems has been generated by IACS. IACS can trace its origins back to the International Load Line Convention of 1930 and its recommendations. The Convention recommended collaboration between classification societies to secure "*as much uniformity as possible in the application of the standards of strength upon which freeboard is based...*". Milestones towards achieving this included the formation in 1948 of the International Maritime Consultative Organization (now IMO), by the United Nations, and major conferences of the leading classification societies in 1939, 1955, and 1968. The last of these led to the formation of IACS, which has since developed more than 200 Unified Requirements (URs) and many Unified Interpretations and Recommendations of rule requirements. The first UR dealing with structural strength unified the classification societies' approaches to maximum wave bending moment, almost 100 years after Rankine's first theoretical model.

IACS was given consultative status with IMO, and works closely with IMO (though with frequent tensions) to address structural and other safety issues through the development of new URs and by other mechanisms. Two notable models can be cited. Under the High-Speed Craft Code, IMO has left structural requirements at a very broad and performance-based level. The responsibility for the development of appropriate rules was left to the classification societies, each of which has developed its own approach. Conversely, in the new Guidelines for Ships Operating in Arctic Waters (Polar Code) IMO has specifically referenced new IACS URs for structural and mechanical design. Representatives of the national administrations and of the classification societies have been involved in the development of both the Guidelines and the URs.

Other important developments within the last decade have included the move towards the use of numerical analysis (FEA) to optimize scantlings, and the development of automated systems (ABS Safehull, DnV Nauticus, etc.) to generate and check most structural components. To some extent, these have led to less standardization amongst class, although in principle all structures should still comply with the intent of the relevant URs. The 'black box' classification society packages simplify the work of the average ship structural designer but do not encourage insight into the structural issues involved. The use of FEA also carries risk for the unwary and for the occasional user, and classification society guidance notes are an imperfect substitute for training and experience.

As noted at Section 1.2.1, numerous navies have recently been abandoning their in-house structural design standards and turning towards classification society naval ship rules (NSR). These new rules have generally been developed in concert with the national classification society, and the ways in which naval and commercial requirements have been combined vary considerably. For example, the LR and GL naval ship rules are essentially customized versions of the general steel (commercial) ship rules. Procedures for certain specialized types of analysis (e.g., shock) are defined, but DnV, dealing with a smaller domestic navy and more export orientation, has used its high speed craft rules as the basis for the naval rules. ABS meanwhile has incorporated much more USN practice directly into its NSR system.

In parallel with these ‘organizational’ changes to standards and to their implementation, the ship rule systems have continued to incorporate some of the developments in the technical state-of-the-art. The following sub-sections present an overview of what this can be considered to be, and of the extent to which it has been incorporated in marine and other structural design standards.

Another recent development is the increased involvement of national and international standards organizations (ASTM, CSA, ISO) in the development of structural standards for ships and offshore structures. To date, these have gained only limited acceptance in the shipping community, but they represent increased competition for traditional rule systems.

The two key aspects that are to be found in these developments can be taken as new treatments of the mechanics of structures (load and strength models) and the treatment of uncertainty (probability models, risk reduction strategies). All developments are aimed at inserting more rational understanding into the process of specifying structural requirements.

#### *1.2.2.2 Load and Resistance Factor Design (LRFD)*

LRFD (Load and Resistance Factor Design) is a relatively recent development, although it has been employed in some standards for a few decades. In certain areas, notably related to buildings, bridges and offshore structures, it is common to use LRFD. The approach attempts to achieve a consistent risk level for all comparable structures by employing calibrated partial safety factors. Various parameters affecting the design, both load and strength related measures, are individually factored to reflect both the level of uncertainty and the consequences of failure, which may range from loss of serviceability to catastrophic collapse. The approach relies on several assumptions about the nature of risk and failure, many of which are reasonable when thinking of the types of hazards (wind, seismic) that a static building will face. The approach implicitly assumes that failure is a consequence of an uncertain load exceeding an uncertain strength, which is a very simplistic model of an accident. The approach does not attempt to model complex (non-linear) paths to failure, including feedback and interdependence, gross errors or any but the simplest of human errors. LRFD has not been implemented in ship structural design, at least partly due to concerns about its suitability.

LRFD is often implemented along with concepts from Limit States (LS) design. LS design attempts to look beyond the intact behaviour, and establish the limits, both from a safety and operational perspective, so that the design point(s) reflect the boundary of unacceptable behaviour. Traditional elastic design, on the other hand, tended to focus on a design point far below a level where actual negative consequences arose. When combined, LRFD and LS design purport to both properly balance risk and reflect, to all concerned, the actual capability limits of the structure. Together, this is intended to clarify and communicate the realistic structural risks. There are ship structural rules that have employed LS design, without LRFD. Two notable examples include the new IACS Unified Requirements for Polar Ships, and the Russian Registry Rules for Ice Class Vessels.

### *1.2.2.3 Formal Safety Assessment (FSA)*

Formal Safety Assessment (FSA) is a recent development in the area of structural standards. FSA is actually more of a standards development approach than a design standard. The International Maritime Organization (IMO) has led the development of this concept. They describe it as "a rational and systematic process for assessing the risks associated with shipping activity and for evaluating the costs and benefits of IMO's options for reducing these risks."

The IMO, and others, are evaluating FSA as a method to comparatively evaluate the components in proposed new regulations or to compare standards. FSA allows for a cost-risk-benefit comparison to be made between the various technical and other issues, including human factors.

FSA is largely a development out of the UK, developed partly in response to the Piper Alpha offshore platform disaster of 1988, where 167 people lost their lives. FSA is being applied to the IMO rule-making process.

FSA offers much promise. The complexity of risk assessment technology itself is probably the major obstacle standing in the way of wider use of the FSA approach.

### *1.2.2.4 Performance Based Standards*

In recent years, there has been a strong trend towards what is generally referred to as performance-based standards (PBS). These standards describe a context and safety targets that they expect the design to meet, and then leave it to the proponent to achieve the targets in any manner they wish. CSA S471 is one example of this approach. In PBS, there are no specific loads or strength levels prescribed. The designers are expected to demonstrate the achievement of a target level of safety by an analysis of the loads and strength. In effect, the proponent is asked to both develop a design standard for their own structure and evaluate it against a risk criterion.

This approach is very popular in certain industries, especially the offshore oil and gas industry, as it enables them to examine a variety of structural and system concepts (gravity based platforms, semi-submersibles, tension-leg platforms, ship shape FPSOs, and others) on a more consistent basis.

The obvious drawback with this approach is the divergence of designs and the possibility for divergence in safety attainment when each project group develops an essential custom design standard. In reality, for most aspects of a design, the proponents will have neither the resources nor the time to develop a complete standard from scratch, and will instead apply existing standards as demonstration that requirements have been met.



### 1.3 Discussion of Structural Standards Development

Taken as a whole, there has been a piecemeal approach to structural design standards. As technical developments occur (models of various structural behaviours, risk methodologies), they have been incorporated into structural standards. Individuals and rule committees have framed their own rules with an emphasis on certain load/strength/failure models, coupled with some risk avoidance strategy (explicit or implicit). It is hardly surprising that various standards are different, even quite different. More, rather than fewer, concepts are available to those who develop structural standards. In the absence of a binding philosophy of structural behaviour, there will continue to be divergence along the way to improved standards.

It must be appreciated that all current standards “work”. Any of the current naval and commercial ship design approaches can be used to produce structural designs that function with adequate reliability over a 20+ year life expectancy, unless subjected to poor maintenance, human operational error, or deliberate damage. Changes to standards are, therefore, resisted by all those who have invested time and effort in them as developers and users. The rationale for change must be presented well, and its benefits have to outweigh its costs.

Experienced designers recognize that structural behaviour can be very complex. Despite this, it is necessary to use simple, practical approaches in design standards, to avoid adding to the problem through overly-complex rules that are difficult to apply and more so to check and audit. Stress is the primary load-effect that standards focus on, partly because it is so readily calculated. The main concerns are material yielding, buckling and fatigue. All of these are local behaviours, and all are used as surrogates for actual structural failure. A structure is a system, comprised of elements, which in turn are built from materials.

As an example, yielding can be considered. Yielding is a material level ‘failure’, very common, usually very localized, and usually producing no observable effect. It can be quite irrelevant. The important issue is the behaviour and failure of the structural system, even at the level of the structural components. Ship structures are especially redundant structures, quite unlike most civil structures and buildings. Ship structures are exposed to some of the harshest loading regimes, yet are usually capable of tolerating extensive material and component failure, prior to actual structural collapse. An essential deficiency of all traditional structural standards has been the failure to consider the structural redundancy (path to failure) and identify weaknesses in the system. Areas of weakness are normally defined as those parts that will first yield or fail.

However, far more important is the ability of the structure to withstand these and subsequent local/material failures and redistribute the load. The real weaknesses are a lack of secondary load paths. It is often assumed, wrongly, that initial strength is a valid indicator for ultimate strength, and far simpler to assess. There is a need to focus on ways of creating robust structures, much as we use subdivision to create adequate damage stability.



As another example, consider frames under lateral loads. When designed properly, frames can exhibit not only sufficient initial strength, but substantial reserve strength, due to the secondary load path created by axial stresses in the plate and frame. In effect, it is possible to create a ductile structure (analogous to a ductile material). If we instead use current design standards that emphasize elastic section modulus, we risk creating a ‘brittle’ structure, even when built from ductile materials.

In the case of fatigue and buckling, it is again necessary to stand back from consideration of the initial effects, and examine whether there is sufficient reserve (secondary load paths). When there is no such reserve, there is the structural equivalent of a subdivision plan that cannot tolerate even one compartment flooding.

The above discussion talks only about structural response, and indicated some gaps. Similar gaps exist in our knowledge of loads. The complexity of ship structures, the complexity of the loads that arise in a marine environment, and the dominating influence of human factors in any risk assessment for vessels, all present daunting challenges.

The project team’s approach to this project, described in the following sections, has intended to provide part of the basis for future design standard development.

## 2. REVIEW OF DESIGN STANDARDS

### 2.1 Summary

This chapter presents an overview of structural design standards. While the focus is on ship structures, the review covers a wide variety of structural standards. Ship and non-ship structures as well as naval and civilian standards are compared. Table 2.1 lists the rule systems that have been reviewed and compared in detail – a longer list has been reviewed in outline and is included with the project bibliography. There are a variety of features that rules may contain. Modern rules vary mainly in the degree to which they employ various features.

**Table 2.1: List of Rules Reviewed**

<b>Rule</b>	<b>Ref.</b>	<b>Application</b>	<b>Comments</b>
ABS Guide for Building and Classing Naval Vessels (July 2004)	1	Naval Ships	Developed in close collaboration with USN (NAVSEA). Not available in the public domain
LR Rules and Regulations for the Classification of Naval Ships (Jan. 2002)	2	Naval Ships	Developed in close collaboration with UK RN, and with additional consultations with other navies (e.g. Canada)
GL Naval Rules (2004)	3	Naval Ships	Developed in close consultation with German navy and industry
ABS Rules (Jan. 2005 )	4	Commercial Ships	Progressive development, internally led
DnV Rules ( July 1998)	5	Commercial Ships	Progressive development, internally led
LR Rules (July 2001)	6	Commercial Ships	Progressive development, internally led
BV Rules (Jan. 2005)	7	Commercial Ships	Progressive development, internally led
Joint Bulker Project (2004)	8	Bulk Carriers	Produced by seven IACS societies (BV,CCS,CNK,GL,KR,RINA,RS) as part of IACS' Common Structural Rules initiative
Joint Tanker Rules (2004)	9	Tankers	Produced by three IACS societies (ABS,DnV,LR) as part of IACS' Common Structural Rules initiative
IACS Unified Polar Rules	10	Ice-going Commercial	produced by IACS in collaboration with various national governments
CSA S6.1 Canadian Highway Bridge Design Code	11	Bridge Code	Developed in government/industry collaboration process
API-RP-2N	12	Offshore Structures	Developed in government/industry collaboration process
CSA S471	13	Offshore Structures	Developed in government/industry collaboration process

## 2.2 Overview of Structural Design Rules

All structural rule systems are intended to assure safe and reliable structures. As a ‘standard’, the rules provide the user with the collected knowledge and experience of the organization(s) and specialists that produced the requirements. The rapid evolution of our technical knowledge and available data has resulted in the rapid evolution of design standards, and even in competition to produce standards that can provide their developer with some form of competitive advantage. At present there are multiple overlapping standards, and designers are frequently faced with having to satisfy at least a few, if not several standards. The aim of this project is to stand back from the variety of standards and describe the overall as well as the specific developments in standards that have occurred. The hope is to be able to define a ‘best practice’ and a ‘way forward’ for ship structural design.

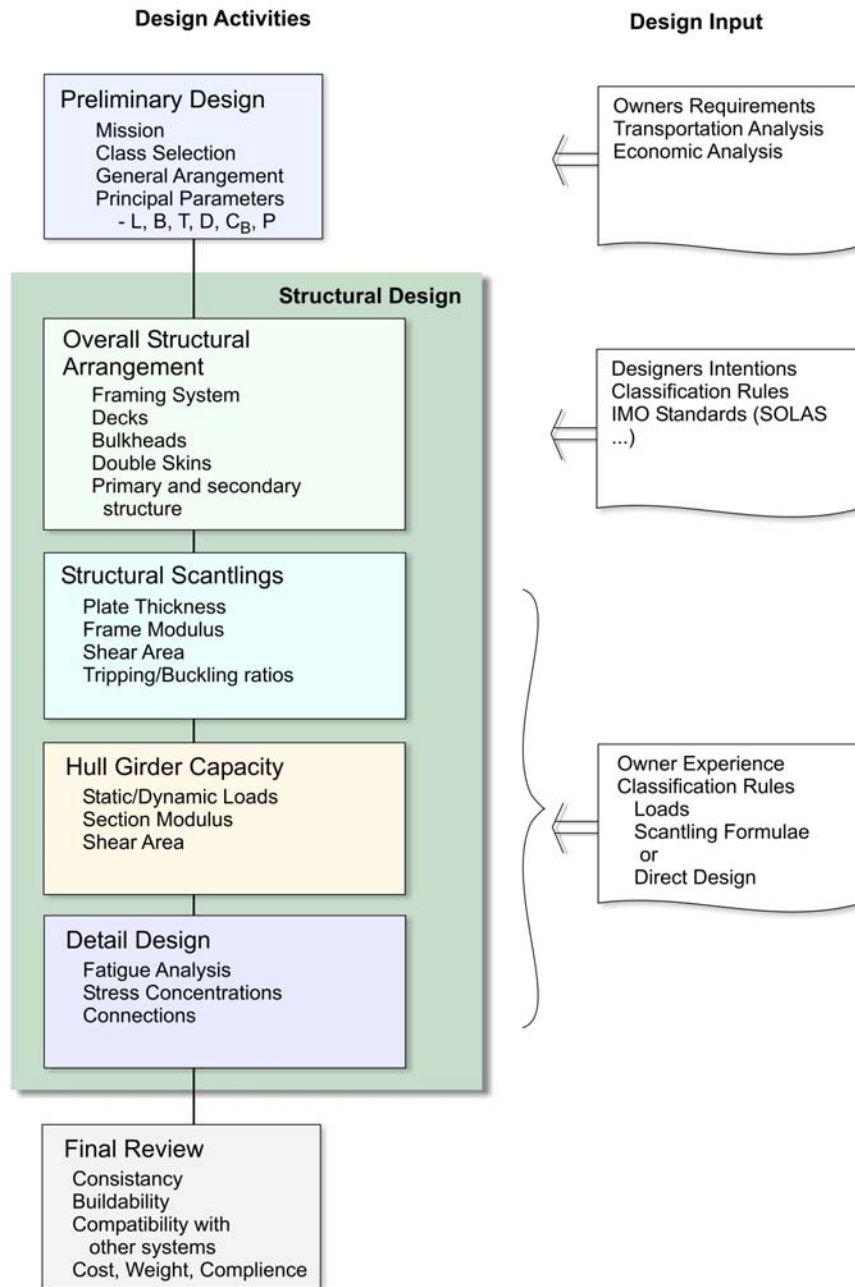
Figure 2.1 is a sketch of the steps that are normally found in most ship structural standards. The preliminary design phase determines what the overall structural design problem is. Structural design follows the preliminary design. The first step in the structural design is the determination of the structural arrangements. As the sketch indicates, there are a variety of factors that control the structural arrangement. These include designers’ intentions, as well as requirements from multiple standards (e.g., IMO, Class, and National authorities). Arrangement rules are one of the types of rules that we will consider.

Following the structural arrangement, the usual next step is the determination of the scantlings. These are largely based on local strength requirements and primarily based (in most cases) on Class rules. The next step is to check and, if needed, to enhance the overall hull girder strength. This is again mainly guided by Class rules. The final step is the design of details such as connections, openings and transitions. These details are guided by Class rules, general published guidance and by yard practices and experience. With this step completed, the structural drawings can be completed.

There is a final step that can affect the structural design. Structure must be reviewed for suitability in light of numerous other constraints. These include compatibility with other ship systems, produceability, maintainability, availability of materials and cost. Each step in 2.1 is part of a design spiral, and is repeated as necessary until a satisfactory result is achieved.

Figure is presented as a point of reference to facilitate discussion of various rule features. When thinking about structural rules, the focus is often on the numerical specifications for scantlings. It is to these numerical specifications that safety factors and other risk measures can be formally applied. Yet there are many different types of components to be found in structural rules. There are suggestions and requirements for the structural arrangements (topology), type of analysis to be performed, and fixed limits on input or output values (minimum, maximum or both). It would seem that all such rule components are included for safety reasons, though some may simply be an expression of ‘proper practice’ for reasons of economy or other design goals. Regardless, these fixed and topological requirements certainly are as important to risk and performance as are the numerical quantities. The next sub-section will discuss various rule features.

**Commercial Ship Design Steps**



**Figure 2.1: Components of Rule-Based Ship Structural Design**

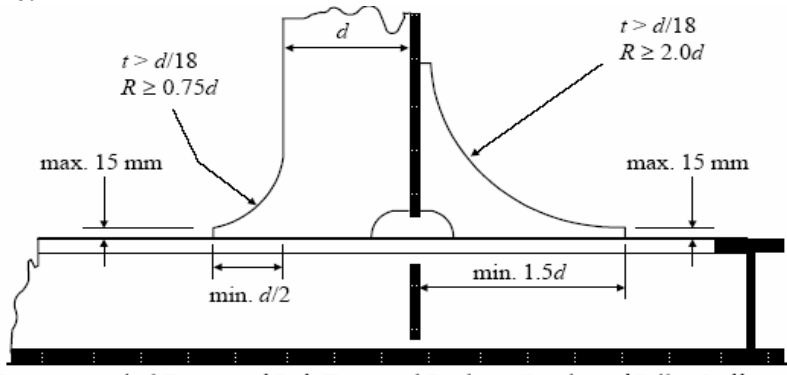
### 2.3 Rule Features

Most ship rules contain the key features as described in Table 2.2. Other non-ship rules contain similar features. Table 2.3 gives examples of these features from the IACS Joint Tanker Rules, as a typical example.

**Table 2.1: Rule Features Found in Most Structural Standards**

<b>Rule Feature</b>	<b>Description</b>
1. Overall Principles	The rule objectives and requirements are described in the broadest terms, as general aims for the designer.
2. Structural Arrangement Requirements	These requirements help to determine the structural layout and even the general arrangement. These requirements reflect concerns for stability (intact and damaged) and overall vessel safety. There are often overlapping requirements from Classification Society Rules and IMO conventions (SOLAS, MARPOL, and ILLC). (e.g. “in single hull ships the inner bottom is to be extended to ...”)
3. Structural Scantling Requirements	<p>The scantling requirements are normally based on one or more of the following approaches:</p> <ol style="list-style-type: none"> <li>1. specified requirements without explicit loads (<b>prescriptive rules</b>)</li> <li>2. mechanics-based requirements with reference to a design load, based on elastic stresses limits (<b>working stress rules</b>)</li> <li>3. mechanics-based requirements, usually based on elastic stresses, but with factors accounting for load and strength variability and target risk levels (<b>LRFD rules</b> – load and resistance factored design)</li> <li>4. specification of preferred theories, approaches and analytical methods to be used in a “first principals” structural strength assessment (<b>first principles rules</b>)</li> <li>5. newer approaches are being developed which often combine elements of the above with more refined risk and mechanics simulations. (<b>simulation based rules</b>)</li> </ol> <p>Note: there is certainly overlap among these rule approaches. The general level of complexity of the rules steadily increases from 1 to 5.</p>
4. Hull Girder Requirements	The hull girder requirements may follow one of the five approaches described above, though not necessarily the same one as used for the local structure. The hull girder design is a special issue within all ship rules, due to the critical importance of the topic. Design may be based on either allowable stress or ultimate limit state design. In either case there may be a probabilistic approach for wave loads determination. Wave loads for commercial rules are normally based on IACS Unified Requirement S.34.
5. Detail Requirements	These requirements are used to avoid local stress concentrations and to prolong ship’s fatigue life.
6. Suggestions	Most rules contain suggestions and guidance notes based on experience and good shipbuilding practice, and are often worded as to allow flexibility (e.g., “the user may...” or “ shall preferably be...”)
7. Cautions	Cautions are strict requirements usually of a non-numerical feature. These are worded to limit the design options (e.g., “point loads acting on secondary stiffeners are to be considered when...”)

**Table 2.2: Examples of Rule Features (IACS Joint Tanker Rules)**

Rule Features	IACS Joint Tanker Rules
1. Overall Principles	The objectives of the Rules are to mitigate the risks and consequences of structural failure in relation to safety of life, environment and property and to ensure adequate durability of the hull structure for its intended life.
2. Structural Arrangement Requirements	A collision bulkhead is to be fitted on all ships and is to extend in one plane to the freeboard deck. It is to be located between 0.05L <sub>L</sub> or 10m, whichever is less, and 0.08L <sub>L</sub> aft of the reference point, where L <sub>L</sub> is as defined in Section 4/1.1.2.1 and the reference point is as defined in 2.3.1.2. Proposals for location of the collision bulkhead aft of 0.08L <sub>L</sub> will be specially considered.
3. Structural Scantling Requirements	Thickness Requirements for Plating is given by: $t = 0.0158 \cdot \alpha_p \cdot s \cdot \sqrt{\frac{P_i}{C_a \cdot \sigma_{yd}}}$
4. Hull Girder Requirements	The net hull girder section modulus about the transverse neutral axis, Z <sub>hg</sub> , based on the permissible still-water bending moment and design wave bending moment are given by the greater of the following: $Z_{hg} = \frac{ M_{sw-perm-sea} + M_{wv} }{\sigma_{allow-sea}} \cdot 10^{-3} \text{ m}^3$ $Z_{hg} = \frac{ M_{sw-perm-harb} }{\sigma_{allow-harb}} \cdot 10^{-3} \text{ m}^3$
5. Detail Requirements	Recommended Detail Design for Soft Toes and Backing Bracket  Recommended Design of Soft Toes and Backing Bracket of Pillar Stiffeners
6. Suggestions	Inner hull and longitudinal bulkheads are to extend as far forward and aft as practicable and are to be effectively scarfed into the adjoining structure.
7. Cautions	Particular attention is to be paid to the continuity of the inner bottom plating into the hopper side tank. Scarfing brackets are to be fitted in the hopper, in line with the inner bottom, at each transverse. These brackets are to be arranged each side of the transverse.

## 2.4 Rule Comparison

Table 2.4 presents an overview of different approaches used by Classification Societies for scantling requirements. In many cases, scantling requirements are moving from prescriptive type of rules toward working stress or LFRD rules.

**Table 2.4: Comparison of Approaches for Scantling Requirements**

<b>Rule</b>	<b>Approaches Used</b>
ABS Guide for Building and Classing Naval Vessels (July 2004)	<b>Prescriptive</b> – Minimum Requirements <b>Working Stress</b> – not used <b>LFRD</b> – not used <b>First Principles</b> – General Requirements <b>Simulation based Design</b> – optional
LR Rules and Regulations for the Classification of Naval Ships (Jan 2002)	<b>Prescriptive</b> – Minimum Requirements <b>Working Stress</b> – General Requirements <b>LFRD</b> – not used <b>First Principles</b> - optional <b>Simulation based Design</b> – optional
GL Naval Rules (2004)	<b>Prescriptive</b> – Minimum Requirements <b>Working Stress</b> – not used <b>LFRD</b> – General Requirements <b>First Principles</b> - optional <b>Simulation based Design</b> – optional
ABS Rules (Jan. 2005 )	<b>Prescriptive</b> – Minimum and General Requirements <b>Working Stress</b> – Requirements for specific vessel types (tankers and bulk carriers over 150 m , container carriers over 130 m) <b>LFRD</b> – not used <b>First Principles</b> – optional <b>Simulation based Design</b> – optional
DnV Rules (July 1998)	<b>Prescriptive</b> – Minimum Requirements <b>Working Stress</b> – General Requirements <b>LFRD</b> – not used <b>First Principles</b> – optional <b>Simulation based Design</b> – Requirements for specific vessel types (tankers, bulk carriers and container carriers over 190 m)
LR Rules ( July 2001)	<b>Prescriptive</b> – Minimum and General Requirements <b>Working Stress</b> – not used <b>LFRD</b> – not used <b>First Principles</b> - optional <b>Simulation based Design</b> – optional
BV Rules (Jan. 2005)	<b>Prescriptive</b> – Minimum Requirements <b>Working Stress</b> – not used <b>LFRD</b> – General Requirements <b>First Principles</b> - optional <b>Simulation based Design</b> – optional

Joint Bulker Rules (2004)	<b>Prescriptive</b> – Minimum Requirements <b>Working Stress</b> – General Requirements <b>LRFD</b> – not used <b>First Principles</b> - optional <b>Simulation based Design</b> – optional
Joint Tanker Rules (2004)	<b>Prescriptive</b> – Minimum Requirements <b>Working Stress</b> – General Requirements <b>LRFD</b> – not used <b>First Principles</b> - optional <b>Simulation based Design</b> – optional
IACS Unified Polar Rules	<b>Prescriptive</b> – not used <b>Working Stress</b> – not used <b>LRFD</b> – not used <b>First Principles</b> – General Requirements <b>Simulation based Design</b> – optional
API-RP-2N Offshore Code	<b>Prescriptive</b> – not used <b>Working Stress</b> – not used <b>LRFD</b> – General requirements <b>First Principles</b> – General Requirements <b>Simulation based Design</b> – optional
CSA S471 Offshore Code	<b>Prescriptive</b> – not used <b>Working Stress</b> – not used <b>LRFD</b> – General Requirements <b>First Principles</b> – General Requirements <b>Simulation based Design</b> – optional

In order to illustrate how these various approaches translate into actual scantling requirements, Table 2.5 provides some examples of the types of design/analysis methodologies that have been defined.



**Table 2.5: Examples of Types of Scantling Requirements**

<b>Scantling Requirements</b>	<b>Examples from Various Rules</b>
<b>Prescriptive rules</b>	Transverse frames section modulus requirements <b>ABS commercial</b> : $SM = s^2(h + bh/30) (7 + 45/l^3) \text{ cm}^3$ where $s$ = frame spacing, in m (ft) $h$ = vertical distance, in m (ft), from the middle of $l$ to the load line or 0.4 $l$ , whichever is the greater. $b$ = horizontal distance, in m (ft), from the outside of the frames to the first row of deck supports
<b>Working stress rules</b>	Side plating, <b>DnV commercial</b> rules: The thickness requirement corresponding to lateral pressure is given by: $t = \frac{15.8 \cdot s \cdot \sqrt{p}}{\sqrt{\sigma}} + tk \text{ mm}$ $p = p_1 - p_8$ , whichever is relevant, as given in Table B1 $\square = 140 f_1$ for longitudinally stiffened side plating at neutral axis, within 0,4 L amidship $= 120 f_1$ for transversely stiffened side plating at neutral axis, within 0,4 L amidship
<b>LRFD rules</b>	Shell plating <b>BV commercial</b> rules:  The net thickness of laterally loaded plate panels subjected to in-plane normal stress acting on the shorter sides is to be not less than the value obtained, in mm, from the following formula: $t = 14.9 c_a c_s \sqrt{\gamma_R \gamma_m \frac{\gamma_{S2} P_S + \gamma_{W2} P_W}{\lambda_L R_y}}$ where: for bottom, inner bottom and decks (excluding possible longitudinal sloping plates): $\lambda_L = \sqrt{1 - 0.95 \left( \gamma_m \frac{\sigma_{x1}}{R_y} \right)^2 - 0.225 \gamma_m \frac{\sigma_{x1}}{R_y}}$ for bilge, side, inner side and longitudinal bulkheads (including possible longitudinal sloping plates): $\lambda_L = \sqrt{1 - 3 \left( \gamma_m \frac{\tau_1}{R_y} \right)^2 - 0.95 \left( \gamma_m \frac{\sigma_{x1}}{R_y} \right)^2 - 0.225 \gamma_m \frac{\sigma_{x1}}{R_y}}$
<b>First Principle Rules</b>	Shell plating and longitudinal stiffeners <b>ABS naval</b> rules:  The shell plating and longitudinal stiffeners shall be designed to withstand axial primary compressive or tensile stresses due to longitudinal hull bending as well as secondary bending and shear stresses due to bending under local loads. Hydrostatic loads on the shell shall be as discussed in Section 3. These include interior as well as exterior hydrostatic loads. Interior and exterior loads shall not be combined. The environmental and service loads shall be based on anticipated service and operating requirements as defined by the Naval Administration.
<b>Simulation based rules</b>	JTP –“The analysis is to cover at least the hull structure over the midship cargo tank region. The minimum length of the finite element model is to cover three cargo tanks about midship. Where transverse corrugated bulkheads are fitted, the model is to include the stool structure forward and aft of the tanks at the model ends.”

This overview of general rule requirements and features will be extended in subsequent sections to explore the approaches and outcomes in greater detail.

### **3. REVIEW OF EXPERIMENTAL AND NUMERICAL DATA.**

#### **3.1 Overview**

Validation of any current or new design standard must include an assessment of the load and strength assumptions. All load and strength formulations are models, based on a combination of rational scientific theory and empirical evidence. This chapter presents a list of publications covering analytical (ANA), experimental (EXP) (both lab and field) and numerical (NUM) investigations that provide data to be used to validate rule formulations. The emphasis here is on models of load and strength that are as accurate as possible. Improved design standards should include, among other aspects, improved load and strength models.

An element of this project has been , therefore, to review the state-of-the-art in marine structural design, as represented by relatively recent publications in leading journals and conference proceedings, that have been further cited in peer-reviewed surveys such as those of the International Ship and Offshore Structures Congress (ISSC), etc. The expectation was that this type of work would be reflected in recent structural design standards; albeit with some level of time lag in the acceptance and adoption of any new approaches.

Full citations for the reference data in Table 3.1 are included at Section 9. These references represent notable, though not necessarily unique, examples of the important types of data available for development of standards. References to additional data and analysis results are included in Section 10, Bibliography. It is certainly beyond the present scope to present a review or even a bibliography of all relevant ship structural data and related material. These references represent further important contributions.

**Table 3.3: Experimental and Numerical Reference Data.**

<b>Reference</b>	<b>Abstract</b>	<b>Relevance</b>	<b>Type</b>
1. Paik et.al. 1998	Numerical investigation of flat bar stiffened panel, subject to uniaxial compression, using non-linear finite element analysis (special purpose code).	Compressive tripping of flat bars	NUM.
2. Paik et.al. 1997	Comparison between experimental data and numerical formulations for ultimate compressive strength of stiffened panels.	Ultimate compressive strength of stiffened panels	NUM. ANA. EXP.
3. Alagusundaramoorthy et.al. 2003	Experimental and numerical investigation of flat bar stiffened panel with initial imperfections under uniaxial compression. In experimental part of investigation six stiffened plates are tested. Initial imperfections formed while connecting the stiffeners to plate were measured. Numerical investigation is carried out using non-linear finite element analysis (special purpose code) based on orthotropic plate approach. For numerical investigation it is assumed that plate have sinusoidal initial deflections.	Stability of stiffened plates with initial imperfections loaded in compression.	EXP. NUM. ANA.
4. Kozlyakov et.al. 2004	Analytical methods for estimation of the ultimate plastic strength of the transverse members that carries a lateral load at simultaneous action of total and local loads.	Ultimate strength of ship grillages	ANA
5. Ostvold et.al. 2004	Nonlinear finite element analysis (SESAM, ABAQUS) of bulk carrier hull girder ultimate strength.	Strategy for ultimate hull girder strength analysis.	NUM
6. Servis et.al. 2002	Finite element analysis of ship-ship collisions using commercial software's.	Implementation of finite element methods for the simulation of ship-ship collisions	NUM
7. Holtsmark et.al. 2004	Development of analytical expression for bending and shear capacity of panel stiffeners. Stiffeners considered were with symmetric and asymmetric cross section, inclined and upright webs, and with and without brackets fitted. Analytical solution was compared with nonlinear FE calculations.	Capacity of panel stiffeners subjected to lateral pressure loads	NUM ANA

Reference	Abstract	Relevance	Type
8. Rutherford 1984	Development of analytical expression for the ultimate capacity of stiffened panels under longitudinal compression and combined longitudinal compression and lateral loading. Comparison between proposed solution and experimental results. Overview of theoretical methods for prediction of unloading characteristics of stiffened panels and comparison with experimental data.	Ultimate strength of stiffened panels under combined longitudinal compression and lateral loading.	ANA
9. DesRochers et.al 1993	Numerical investigation of post yield buckling response of panel stiffeners under lateral loading using FEM. Development of simplifying FE modeling procedure for post-yield buckling analysis of stiffened panel structures.	Post –yield buckling strength of stiffened panels under lateral loading	NUM
10. Schluter et.al. 2001	Development of the concept for hull girder FE analysis for inland water ships.	Strategy for hull girder strength analysis	NUM
11. Akhras, G., et. al. 1998	An experimental simulation of the behaviour of the hull by loading a box girder up to its ultimate strength. The girder was subjected to pure bending until failure occurred, with collapse due to buckling and not to plastic failure. Residual stresses and initial geometrical imperfections were measured.	hull girder strength analysis	EXP
12. Hu. et.al. 1997	A full-scale testing system was designed and constructed to provide data for stiffened steel plate units under combined axial and lateral loads. The system included an assembly of discrete plate edge restraints that were developed to represent symmetric boundary conditions within a grillage system. Twelve full-scale panels including 'as-built', 'deformed' and 'damaged' specimens were tested in this set-up. Specimens failed by combined plate and flexural buckling, stiffener tripping or local collapse, depending on the lateral loads and local damage. Load-shortening curves associated with different failure modes were found to be distinctly different and it was found that a small lateral load could change the failure mode from flexural buckling to tripping.	Stiffened panel tests	EXP

Reference	Abstract	Relevance	Type
13. Hu. et.al. 1998	A series of nonlinear finite element analyses were conducted to simulate the test procedure and predict the collapse loads and buckling behavior of these stiffened panels. The finite element models were established by a direct mapping of measured imperfections to nodal points. Residual stresses were introduced using a thermal stress analysis procedure. For models with spatial discontinuities, locally refined meshes and the branch shifting technique were used to achieve the desired failure modes. In this paper, the finite element solutions are	Stiffened panel finite element modeling	NUM
	presented in detail and compared with the test observations. The good agreement between the experimental and numerical results indicates that the nonlinear finite element method is capable of predicting plastic post-buckling behavior of stiffened panel structures.		
14. Rigo. et.al. 2003	Extensive sensitivity analysis carried out by the Committee III.1 "Ultimate Strength" of ISSC'2003 in the framework of a benchmark on the ultimate strength of aluminum stiffened panels	Stiffened panel finite element modeling	NUM
15. Gielen. Et.al. 2004	An investigation was carried out into a potential benefit of high tensile strength steels when they are subjected to dynamic loads. The application considered in this investigation are the panels in the wet deck, the bow fore foot at the bow flare area of fast ships. For investigation purposes a drop box was used. Relatively simple 2D fluid-structure finite element calculations were setup to predict the experimental results. The computational results are in good agreement with the experiments.	Dynamic stiffened panel experiments and finite element modeling	EXP, NUM

<b>Reference</b>	<b>Abstract</b>	<b>Relevance</b>	<b>Type</b>
16. Naar 2006	<p>The ultimate strength of the hull girder for large passenger ships with numerous decks and openings was investigated. In this study, a theory of a non-linear coupled beam method was created. These beams are coupled to adjacent beams with non-linear springs called vertical and shear members. A semi-analytic formula of the load-displacement curve was developed by help of the non-linear finite element analysis.</p> <p>The ultimate strength of the hull girder was studied also with the non-linear finite element method. This required an investigation of the element mesh configuration in order to find an optimum mesh type and size. The results on the structural failure modes show clearly that the shear strength of the longitudinal bulkheads and side structures is a very important issue</p>	Whole-ship non-linear /dynamic finite element modeling	NUM

## 4. QUALITATIVE COMPARISON OF THE RULES

### 4.1 Introduction

The objective of this element of the project was to establish a basis for the systematic classification of standards and to evaluate the set of standards identified in Section 2.

A comparison of structural design rules and standards for all the systems under consideration indicates that their features can be reduced to the following key components:

- i) an idealization approach;
- ii) a definition of the loading regime;
- iii) a response definition; and
- iv) a factor of safety.

It is often the case that the rules only give a set of requirements in the form of tables and equations. The four components listed above are not explicitly identified, but are nevertheless evident in the tables and formulations. The following sections examine several classes of rules (commercial ship, naval ship, civil structures), and describe their components and how they were identified.

The DnV Rules for Ships (July 1998 used for comparison, but more recent issues are very similar) are typical of commercial ship requirements, and will be used as a base case. These will be compared with the new Joint Bulker and Joint Tanker requirements, as well as the ABS Container ship rules. These rules are generally quite similar in form and use. The BV rules, which are unique in that they use an LRFD (Load and Resistance Factored Design) format, will also be examined, as will some other less “mainstream” rules. None of the Naval Ship Rules is presented in detail, but their comparable requirements are almost identical in most cases to the approach of the commercial systems. This will be demonstrated in Section 5.

The focus of the assessment and of subsequent analyses will be strength requirements for plating and for framing; ignoring instability, fatigue, and other design requirements in order to bound the project scope.

As will become obvious in the coming sections, the current standards under examination all contain relatively simple structural mechanics. None appear to contain any of the type of more sophisticated mechanical and structural behaviours reflect in the references listed in Section 3. This is somewhat surprising upon reflection, and raises the question of just how new structural standards should incorporate the latest structural research. This issue will be discussed further in Section 6.

## 4.2 Current Commercial Ship Rules

### 4.2.1 DnV Plating Requirements

The bottom structure, which is representative of the design philosophy, forms the focus of the comparison. The plating, framing and hull girder requirements are linked together in a way that appears to account for combined stress effects. As a starting point, the DnV plate formulae are examined. The shell thickness is given by;

$$t = \frac{15.8 \cdot s \cdot \sqrt{p}}{\sqrt{\sigma}} + t_k \quad (4.1)$$

Where  $t$  : thickness [mm]  
 $s$  : frame spacing [m]  
 $p$  : pressure [kPa]  
 $t_k$  : corrosion addition [mm]

This equation contains five terms (in addition to  $t$ ), each of which can be examined to see what mechanics are implied and to determine if any factor of safety is included. To start, the overall form of the equation is examined. The equation is essentially a plate response equation, inverted to become a thickness design equation. When converted to an equation with consistent units ( $t$  and  $s$  in mm, and  $p$  and  $\sigma$ , in MPa), it becomes;

$$t = .5 \cdot s \sqrt{\frac{p}{\sigma}} + t_k \quad (4.2)$$

Converted to a capacity equation (ignoring the corrosion addition);

$$p = 4 \cdot \sigma \cdot \left(\frac{t}{s}\right)^2 \quad (4.3)$$

The standard plate response equation, giving the pressure to cause yielding, is;

$$p_{yield} = 2 \cdot \sigma \left(\frac{t}{s}\right)^2 \quad (4.4)$$

Clearly the DnV equation is showing a response beyond yield. The standard load and deflection equations for a long plate with a uniform load, and fixed at the edges are given in Table 4.1. As well, Figure 4.1 shows a sketch of the three conditions. As equation (4.3) includes a constant of 4, it is clear that the DnV plate design equation allows the plate to exceed yield. If the plate equation were to have been based on yield, the constant would have been 21.1 instead of 15.8. Equation (34.4) expresses the linear relationship between load and stress. This can be expressed also as;

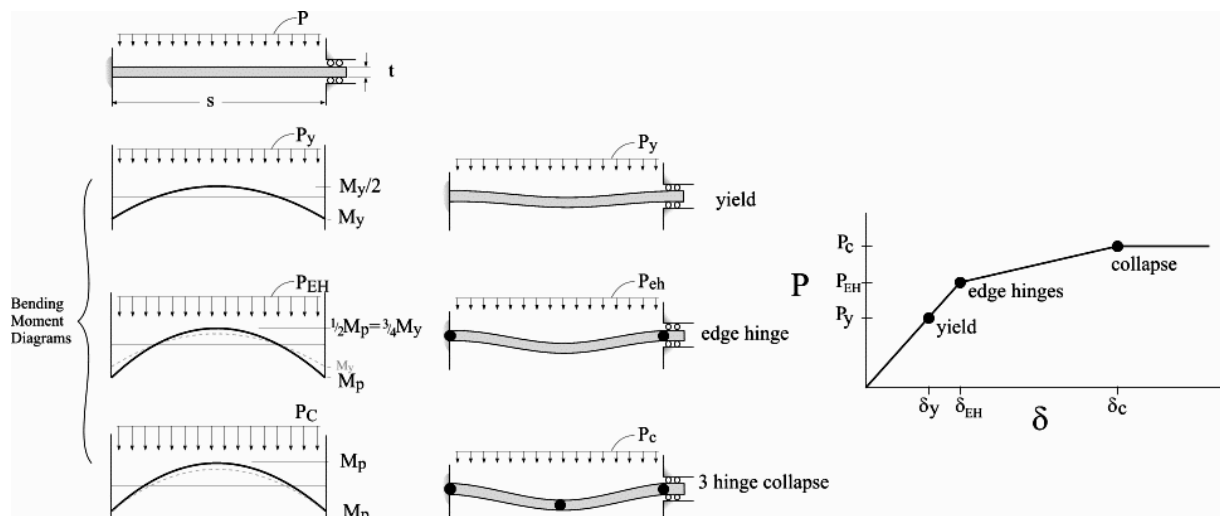
$$t = .707 \cdot s \sqrt{\frac{p}{\sigma}} \quad (4.5)$$



One could think that equation (4.2) actually underestimates the stress that will occur when  $p$  is applied. This will become important when combined elastic stresses are later examined. This raises the question of whether it is reasonable to think of the plate being partially plastic, and then to combine stresses in an elastic manner.

**Table 4.1: Plate Response Equations**

<u>Behavior</u>	<u>Load</u>	<u>Deflection</u>
Yield	$p_Y = 2 \cdot \sigma \left(\frac{t}{s}\right)^2$	$\delta_Y = \frac{1}{384} \frac{p_Y s^4}{D}$
Edge hinge	$p_{EH} = 3 \cdot \sigma \left(\frac{t}{s}\right)^2$	$\delta_{EH} = \frac{1}{384} \frac{p_{EH} s^4}{D}$
Collapse	$p_C = 4 \cdot \sigma \left(\frac{t}{b}\right)^2$	$\delta_C = \frac{2}{384} \frac{p_C s^4}{D}$



**Figure 4.1. Plate Behaviour Diagrams**

Based on the above, it can be concluded that the plate design equation uses a constant that implies some amount of yielding in the plate, possibly up to nominal 3-hinge collapse. This appears to be non-conservative, but when added to other factors, appears to be a reasonable statement of plate capability. Other factors that will tend to raise the plate capacity are:

- ✘ real plates will have finite aspect ratio plates, and will tend to be stronger than long plates (say by 5-10%);
- ✘ actual yield strength tends to be above specified values;
- ✘ strain hardening will tend to add capability in the post yield region;

- ✘ membrane effects will tend to help, though only at very large deflections; and
- ✘ A plate designed with (4.2) would show a very small degree of permanent deformation (not likely visible).

Collectively, these may raise effective linear (useful working) capacity of the plate by 10-30% (see analyses at Section 5 below).

Factors that tend to reduce plate capacity are:

- ✘ aging effects (fatigue, corrosion);
- ✘ poor workmanship and random flaws; and
- ✘ non-uniform load patterns

From the above, it is concluded that the 15.8 constant in equation (4.1) does not include a factor of safety, and probably represents a condition in which the plate has some yielding, and small permanent deflection. Now the design load (pressure) is examined.

The design pressure (for bottom plating near midships) is given by

$$p = 10 \cdot T + p_{dp} \quad (4.6)$$

Where  $p$  : pressure [kPa]

$T$  : draft [m]

$p_{dp}$ : dynamic pressure

The constant 10 is the weight density of seawater (in kN/m<sup>3</sup>). In other words, the design pressure is just the static head at the design draft, plus some dynamic increase. The equation for  $p_{dp}$  is somewhat complex, but typically adds only about 20% to the static head. As such, the design pressure does not appear to include any factor of safety. It is perfectly plausible that a typical plate panel will experience the design pressure on a regular basis, even when the ship is in the undamaged condition. Damage may well lead to deeper drafts. There does not appear to be any allowance for other types of loads, or uncertainties, contained in the pressure term.

Next, the allowable stress  $\sigma$  is examined. Mild steel is assumed (yield strength of 235 MPa), so that the material factor  $f_1$  is 1.0. The allowable plate stress is;

$$\sigma = 175 \cdot f_1 - 120 \cdot f_{2b} \text{ , not to exceed } 120 \cdot f_1 \text{ (for transverse frames)} \quad (4.7)$$

$$\sigma = 120 \cdot f_1 \text{ , (for longitudinal frames)} \quad (4.8)$$

Where  $f_{2b}$  = hull bending stress factor:

$$f_{2b} = 5.7 \frac{(M_s + M_w)}{Z_B} \quad (4.9)$$

Where  $M_S$  : max still water bending moment  
 $M_W$ : design wave bending moment  
 $Z_B$  : as built section modulus

$Z_B$  may be equal to or greater than the minimum required modulus ( $Z_R$ ). If  $Z_B = Z_R$

Then

$$f_{2b} = 5.7 \frac{(M_S + M_W)}{1000 \cdot (M_S + M_W) / (175 \cdot f_1)} = f_1 \quad (4.10)$$

Typically  $Z_B = k Z_R$ , where  $k = 1.1$  to  $2.0$ , and so  $f_{2b} = (.91 \text{ to } 0.5) f_1$ . However, normally  $f_{2b}$  will be assumed to be 1.

#### 4.2.2 DnV Framing and Hull Girder Requirements

The requirements for ordinary stiffeners in DnV rules are given by the following formulas:

$$Z = \frac{83 \cdot l^2 \cdot s \cdot p \cdot w_k}{\sigma} \text{ cm}^3, \text{ for longitudinal stiffeners} \quad (4.11)$$

$$Z = \frac{0.63 \cdot l^2 \cdot s \cdot p \cdot w_k}{f_1} \text{ cm}^3, \text{ for transverse stiffeners} \quad (4.12)$$

Where  $Z$  : required section modulus [ $\text{cm}^3$ ]  
 $s$  : frame spacing [m]  
 $p$  : pressure [kPa]  
 $l$  : frame span [m]  
 $\sigma$  : allowable stress [MPa]  
 $w_k$ : corrosion addition, and  
 $f_1 = 1$  for mild steel (yield 235 MPa)

In both equations, the design pressure is the same as for plating and no additional explanation is needed. The idealization approach, response definition and factors of safety require further clarification.

First consider the longitudinal stiffeners. When equation (4.11) is converted to one with consistent units it becomes:

$$Z = \frac{l^2 \cdot s \cdot p \cdot w_k}{12 \cdot \sigma} \quad (4.13)$$

Where  $(\frac{l^2 \cdot s \cdot p}{12})$  is the maximum bending moment  $M$  for a fixed – fixed beam subjected to a uniform load. Ignoring the corrosion addition and rearranging equation 4.13, the standard bending equation:

$$\sigma = \frac{M}{Z} \quad (4.14)$$

Clearly the idealization approach used in DnV rules for longitudinal stiffeners is:

- Fixed – fixed beam
- Uniform pressure
- Elastic design

The allowable stress  $\sigma$  for longitudinal stiffeners (single bottom ships) is given by:

$$\sigma = 225 \cdot f_1 - 130 \cdot f_{2b} \quad (4.15)$$

Similar to plates the term  $f_{2b}=1$ , and consequently the allowable stress is  $\sigma = 95MPa$ . The allowable stress is less than yield for the same reasons as before (interaction between hull girder, plating and framing stresses).

From the above, it is concluded that longitudinal stiffeners are treated as fixed-fixed beams under lateral uniform loading, designed for yield strength with no explicit factors of safety. The only reserve will be due to plastic capacity.

A similar analysis is done for transverse stiffeners (equation 4.12). Ignoring corrosion addition and rearranging (4.12) to one with similar to (4.13) with consistent units, the equation becomes:

$$Z = \frac{l^2 \cdot s \cdot p \cdot w_k}{12 \cdot \sigma_T} \quad (4.16)$$

Where  $\sigma_T = 130$  and  $(\frac{l^2 \cdot s \cdot p}{12})$  is maximum bending moment  $M$  for the fixed – fixed beam

subjected to uniform load. This shows that, though unstated, transverse frames are designed as fixed-fixed beam under lateral uniform loading with an allowable stress of 130 MPa.

The required hull girder section modulus in DnV rules is given by the following formulae:

$$Z_R = \frac{(M_S + M_W)}{\sigma_L} \cdot 10^{-3} \text{ cm}^3 \quad (4.17)$$

Where  $M_S$  : max still water bending moment

$M_W$ : design wave bending moment

$Z_R$  : required section modulus

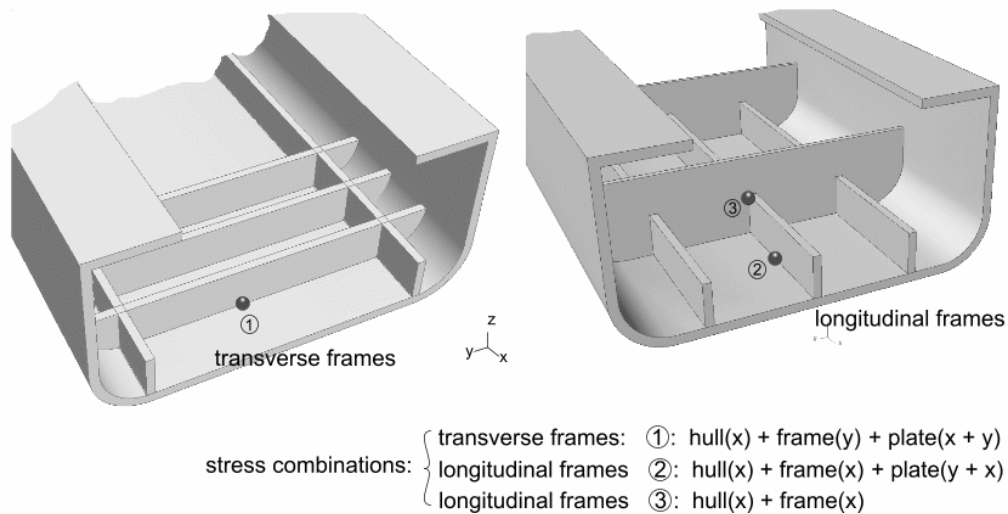
$\sigma_L$  : allowable stress = 175 MPa

This is a standard bending requirement formula where the hull girder is considered as a free-free beam. Allowable stress is reduced due to interactions between local and hull girder stresses. Only wave and still water effects are included.

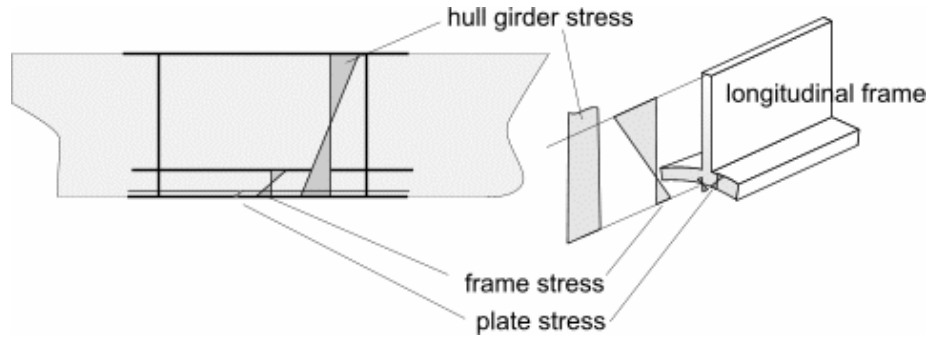
### 4.2.3 DnV Combined Stress Results

In the DnV plating formula, the allowable stress formula depends on the type of framing, longitudinal or transverse. The reason for this is illustrated in Figure 4.2 and Figure 4.3. For location '1' in Figure 4.2, the maximum plate bending stresses are aligned with the hull girder stresses and at right angles with the frame bending stresses. For location '2' the maximum frame bending stresses are aligned with the hull girder stresses and at right angles with the plate bending stresses. At both locations '1' and '2', the frame bending stress is assumed to be 1/8 of the design value. The moments at the center of the frame are half of the end values, and the modulus on the shell plate side is assumed to be 1/4 of the flange side value. In the case of the plate, there is always a primary bending stress and a Poisson's ratio effect. The Poisson's effect gives a 30% stress of the same sign in the other direction (i.e., in the along frame direction). This is based on the long plate assumption.

Table 4.2 shows the calculated combined stresses that result from the DnV rules. At locations '1' and '2' the combined stresses are very close to the nominal yield stress. Figure 4.4 plots the three cases on a bi-axial stress plot with the von-Mises yield criteria shown as an oval. The combined stresses are at or above yield.



**Figure 4.2: Locations to Check Stress Combinations**



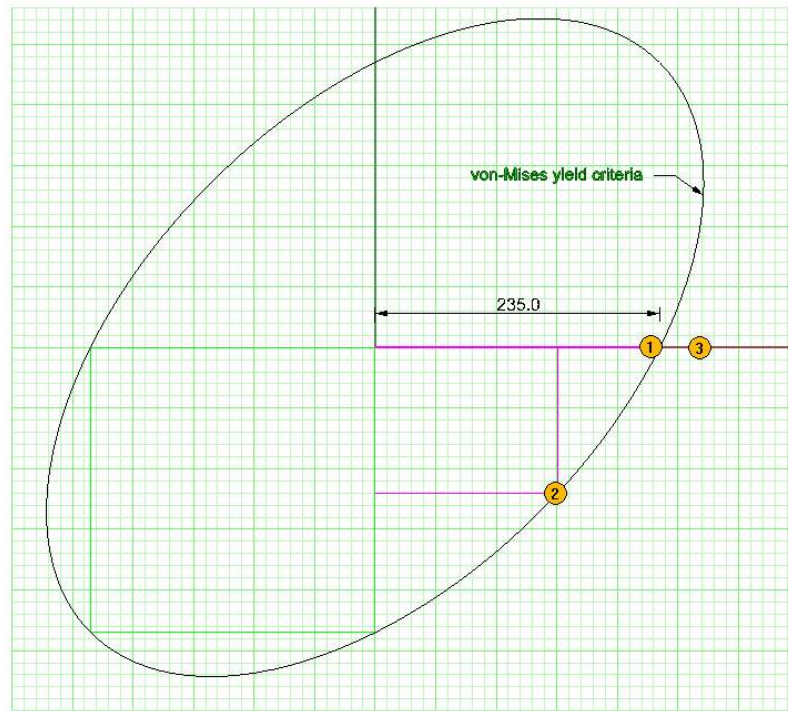
**Figure 4.3: Stress Superposition (Longitudinal Frame Case)**

**Table 4.2: Calculated Combined Stresses for DnV Commercial Rules**

Location	Assumptions	Hull girder stress [MPa]	Plate stress [MPa]	Ordinary frame stresses [MPa]	VM Total Stress [MPa]
1	$Z_B = Z_R$ (note 1)	$175 (x-t)$ (note 2)	55 (x-t), 17 (y-t)	~ 16 (y-c)	230
	$Z_B = 2 Z_R$	87.5 (x-t)	115 (x-t) + 34.5 (y-t)	~ 16 (y-c)	212
2	$Z_B = Z_R$	175 (x-c)	36 (x-t), 120 (y-t)	~ 12 (x-c)	235
3	$Z_B = Z_R$	175 (x-t)		95 (x-t)	270

Note 1: It is assumed that section modulus at the locations considered ( $Z_B$  for the bottom) are normally the same as the design values ( $Z_R$  = required hull girder min. modulus). In other words, the full allowable hull girder stress is assumed to combine with the plate and frame stresses. In one case, a higher value of modulus is assumed. Actual values will be ship dependant.

Note 2: The stress direction (x for longitudinal dir'n, y for transverse dir'n) and the sense (c-compression, t-tension) are indicated. The worst possible senses were assumed.



**Figure 4.4: Von-Mises Stress Calculations (Cases in Table 4.2).**

#### 4.2.4 Qualitative Comparison of DnV, JBR and JTR Requirements

The DnV rules have been taken as a point of reference for the further qualitative and quantitative rule comparison with the new Joint Tanker Rules (JTR) and Joint Bulker Rules (JBR).

Formulas for nominal (net) plate thickness (without corrosion allowance) in these rules are given as:

$$\text{DnV; } t = 15.8 \cdot s \cdot \sqrt{\frac{P_i}{\sigma}} \text{ mm} \quad (4.18)$$

$$\text{JTR; } t = 0.0158 \cdot \alpha p \cdot s \cdot \sqrt{\frac{P_i}{C_a \cdot \sigma_y}} \text{ mm} \quad (4.19)$$

$$\text{JBP; } t = 15.8 \cdot C_a \cdot C_r \cdot s \cdot \sqrt{\frac{P_s + P_w}{\lambda p \cdot R_y}} \text{ mm} \quad (4.20)$$

Table 4.3 presents a qualitative summary of the comparison of DnV commercial rules with JBR and JTR for bottom plating. It is not obvious that there is any significant factor of safety built into the plate rules. The basic plate equation (the constants) is non-conservative against yield. The plate pressures are not very high, meaning that one might be able to actually measure these pressures in a field trial in rough weather. The allowable stresses, while individually well below yield, are such that the combined stresses (plate+ frame + hull) are generally at or above the yield stress. One can only conclude that if the design loads were to occur, the structure would certainly begin to fail. If there is any implicit factor of safety, it may be in the hull girder design bending moment, which is meant to be a rare moment.

**Table 4.3: Commercial Rules Design Criteria for Bottom Structure Plating**

<b>Structural Design Criteria</b>	<b>DnV Commercial Rules</b>	<b>JBR</b>	<b>JTR</b>
i. idealization approach	<ul style="list-style-type: none"> <li>- long plate</li> <li>- fixed-fixed boundary conditions + uniform load (symmetry)</li> </ul>	<ul style="list-style-type: none"> <li>- uses same constant and apparently the same assumptions</li> <li>- panel curvature is included</li> </ul>	<ul style="list-style-type: none"> <li>- uses same constant and apparently the same assumptions</li> <li>- aspect ratio is considered when &lt; 3</li> </ul>
ii. loading regime	<ul style="list-style-type: none"> <li>- uniform pressure</li> <li>- hydrostatic pressure to design draft + wave induced dynamic pressure (north Atlantic wave)</li> </ul>	<ul style="list-style-type: none"> <li>- same</li> </ul>	<ul style="list-style-type: none"> <li>-same</li> </ul>
iii. response definitions	<ul style="list-style-type: none"> <li>- a post yield condition is implied by the equation - edge hinge or 3 hinge formation</li> <li>- plate, frame and hull girder stresses add to each other using von-Mises criteria</li> </ul>	<ul style="list-style-type: none"> <li>- same</li> </ul>	<ul style="list-style-type: none"> <li>- same</li> </ul>
iv. apparent factors of safety	<ul style="list-style-type: none"> <li>- no explicit safety factors</li> <li>- not implicitly in design stress (yield)</li> <li>- not implicitly in a constant</li> <li>- not implicitly in loading</li> <li>- possibly in plastic reserve (membrane + strain hardening)</li> <li>- possibly in hull wave load</li> </ul>	<ul style="list-style-type: none"> <li>- same</li> </ul>	<ul style="list-style-type: none"> <li>- same</li> </ul>

Table 4.4 presents a qualitative summary of the comparison of DnV commercial rules with JBR and JTR for bottom framing. It appears again that the JBR and JTR are not very different from the DnV rules, although the newer formulations are somewhat more complex.



**Table 4.4: Commercial Rules Design Criteria for Bottom Structure Ordinary Framing**

Structural Design Criteria	DnV	JBR	JTR
i. idealization approach	- continuous beams, fully loaded, equivalent to fix-fixed beams - elastic response only	- same	- same
ii. loading regime	- uniform pressure - hydrostatic pressure to design draft + wave induced dynamic pressure	- same	- same
iii. response definitions	- elastic yield - longitudinal frames are (partially) added to hull girder stresses - transverse frame stresses are not added to hull girder - no bending and shear interaction	- same	- same
iv. apparent factors of safety	- no explicit safety factors - not implicitly in design stress (yield) - not implicitly in a constant - not implicitly in loading - possibly in plastic reserve (membrane + strain hardening) - possibly in hull wave load	- same	- same

#### 4.2.5 Quantitative Comparison of DnV with ABS Container Ship Requirements

ABS rules for container ships have also been compared with the DnV rules, as another check of standard commercial ship rules.

The ABS net plate thickness formulae consist of three parts:

$$t_1 = 0.73 \cdot s \cdot \sqrt{\frac{K_1 \cdot P}{f_1}} \text{ mm (longitudinal plating)} \quad (4.21)$$

$$t_2 = 0.73 \cdot s \cdot \sqrt{\frac{K_2 \cdot P}{f_2}} \text{ mm (transverse plating)} \quad (4.22)$$

$$t_3 = c \cdot s \cdot \sqrt{\frac{Sm \cdot f_y}{E}} \text{ mm, (plate buckling check)} \quad (4.23)$$

The  $t_1$  value was used in further quantitative comparison with following assumptions:

- buckling ( $t_3$ ) is not critical
- longitudinal framing

Expressing the initial ABS and DnV formulas in the same units:

$$t_{ABS} = 427 \cdot s \cdot \sqrt{\frac{P}{f_1}} \text{ mm} \quad (4.24)$$

$$t_{DnV} = 499 \cdot s \cdot \sqrt{\frac{P}{\sigma}} \text{ mm} \quad (4.25)$$

However, the ratio between allowable stresses is  $\frac{\sigma}{f_1} = \frac{120}{94} = 1.27$

If the allowable stresses were the same, the constant in the DnV formula becomes 391. Consequently the difference in the plate thickness for the same loading is only 10%, not 27%.

However, the corrosion addition in DnV rules for the plates exposed to the sea water is  $t_k = 2.5$  mm, while the corrosion addition in these ABS rules for the plates exposed to the sea water is  $t_k = 1.5$  mm. This tends to minimize any difference in as-built scantlings between the two rule sets.

#### 4.2.6 Comparison of Combined Stress value in DnV, JBR, JTR and ABS Container Ship Requirements

The combination of stresses for locations 1, 2 and 3 are shown in Table 4.5. In addition to the DnV values, comparable values from the Joint Bulker (JBR), Joint Tanker (JTR) rules and the ABS rules for Container ships are given. From the sum of the x and y direction stresses, the von-Mises equivalent stress is also calculated;

$$\sigma_{VM} = \sqrt{\sigma_x^2 - \sigma_x \sigma_y + \sigma_y^2} \quad (4.26)$$

The combined stresses shown in Table 4.5 assume that the stresses at the plate-frame intersection contain hull girder, frame and plate bending stresses, and that the stresses are potentially of any sign (compression or tension)

**Table 4.5: Combined Stresses at the Locations Shown in Figure 4.2  
for DnV, JBR, JTR and ABS**

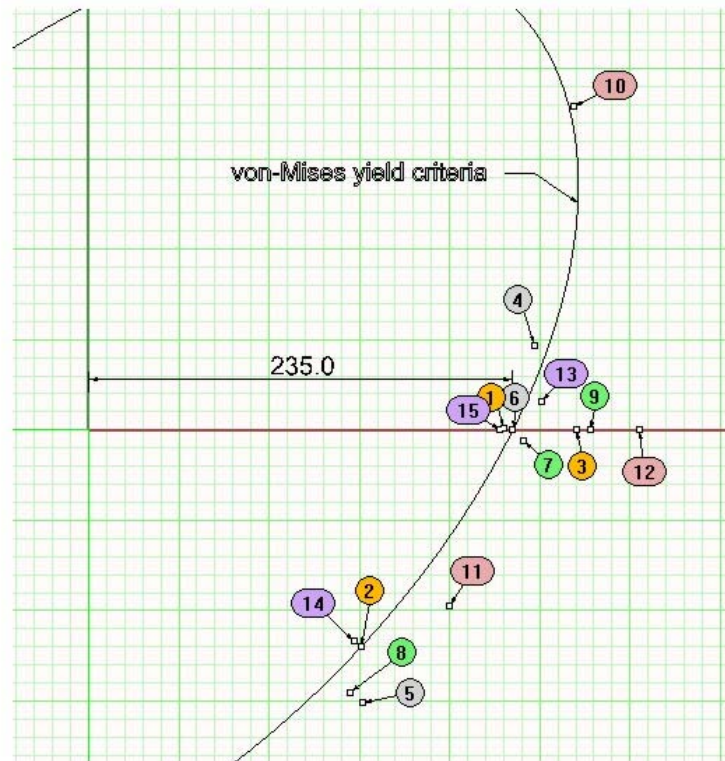
<b>Rule Types and Positions</b>	<b>Location</b>	<b>Assumptions</b>	<b>Hull Girder Stress [MPa]</b>	<b>Plate Stress [MPa]</b>	<b>Ordinary Frame Stresses [MPa]</b>	<b>VM Total Stress [MPa]</b>
DnV	1	$Z_B = Z_R$ <sup>(note 1)</sup> $Z_B = 2 Z_R$	175 (x-t) <sup>(note 2)</sup> 87.5 (x-t)	55 (x-t), 17 (y-t) 115 (x-t) + 34.5 (y-t)	~ 16 (y-c) ~ 16 (y-c)	230 212
	2	$Z_B = Z_R$	175 (x-c)	36 (x-t), 120 (y-t)	~ 12 (x-c)	235
	3	$Z_B = Z_R$	175 (x-t)		95 (x-t)	270
JTR	1	$Z_B = Z_R$	190 (x-t)	57(x-t), 17 (y-t)	~30 (y-t)	240
	2	$Z_B = Z_R$	190 (x-c)	45(x-t), 152(y-t)	~ 6 (x-c)	262
	3	$Z_B = Z_R$	190 (x-t)		45 (x-t)	235
JBP	1	$Z_B = Z_R$	175 (x-t)	66(x-t), 20(y-t)	~ 26.5 (y-c)	237
	2	$Z_B = Z_R$	175 (x-c)	43(x-t), 145(y-t)	~ 13 (x-c)	250
	3	$Z_B = Z_R$	175 (x-t)		103 (x-t)	278
ABS Container Ships	1	$Z_B = Z_R$	175 (x-t)	94 <sup>(note 3)</sup> (x-t), 200(y-t)	21 (y-c)	237
	2	$Z_B = Z_R$	175 (x-c)	94 <sup>(note 3)</sup> (x-t), 200(y-t)	~16 (x-c)	262
	3	$Z_B = Z_R$	175 (x-t)		130 (x-t)	305

Note 1: It is assumed that section modulus at the locations considered ( $Z_B$  for the bottom) are normally the same as the design values ( $Z_R$  = required hull girder min. modulus). In other words, the full allowable hull girder stress is assumed to combine with the plate and frame stresses. In one case, a higher value of modulus is assumed. Actual values will be ship dependant.

Note 2: The stress direction (x for longitudinal dir'n, y for transverse dir'n) and the sense (c-compression, t- tension) are indicated. The worst possible senses were assumed.

Note 3: Allowable plating stresses in ABS formulas are defined as allowable stresses in transverse and longitudinal direction. Allowable stresses are not associated with framing orientation like in the rest of the considered rules.

ABS is using Poisson ratio of approx. 0.5.



**Figure 4.5: Von-Mises Combined Stress Calculations (Cases in Table 4.5 and 4.6).**

Figure 4.5 shows the combined stresses for all 12 cases in Table 4.5 as well as Table 4.6. It is interesting to see that in all rule sets for location ‘1’ the combined equivalent stress is approximately equal to 235 MPa, as might be expected. Overall, most values are in the range of 235-300. Variations in the equivalent stresses (especially for position 3) may be the result of several factors:

- different ship types (general cargo, tanker, bulk carrier, container carrier) will have different positions of neutral axis, and so will raise or lower the hull stress component.
- There may be an allowance for a certain degree of plasticity in the response. However, the relatively low value of the plate design constant (15.8) will tend to result in an underestimate of the plate stresses. Hence the Table 4.5 stresses are, if anything, on the low side (for the assumptions made).

The constant in the plate formula is below the elastic value. Consequently, the true stress at the design pressure would be higher (by 21.1/plate constant). And, as the plate stresses only form part of the combined stresses, it is reasonable to adjust the plate stress to reflect the lower constant. Table 4.6 shows the adjusted stresses that result from this effect.

**Table 4.6: Adjusted Combined stresses at the locations shown in Figure 4.6 for DNV, JBR, JTR and BV**

Rule Types and positions	Case	Location	Assumptions	Hull girder stress [MPa]	Plate stress [Mpa]	Ordinary frame stresses [Mpa]	VM Total Stress [Mpa]
DNV	1*	1	$Z_B = Z_R$ <sup>(note 1)</sup> $Z_B = 2 Z_R$	175 (x-t) <sup>(note 2)</sup> 87.5 (x-t)	73 (x-t), 22 (y-t) 154 (x-t) + 46(y-t)	~ 16 (y-c) ~ 16 (y-c)	245 228
	2*	2	$Z_B = Z_R$	175 (x-c)	48 (x-t), 160 (y-t)	~ 12 (x-c)	259
	3	3	$Z_B = Z_R$	175 (x-t)		95 (x-t)	270
JTR	4*	1	$Z_B = Z_R$	190 (x-t)	76(x-t), 23 (y-t)	~30 (y-t)	244
	5*	2	$Z_B = Z_R$	190 (x-c)	61(x-t), 203(y-t)	~ 6 (x-c)	295
	6	3	$Z_B = Z_R$	190 (x-t)		45 (x-t)	235
JBP	7*	1	$Z_B = Z_R$	175 (x-t)	88(x-t), 26(y-t)	~ 26.5 (y-c)	263
	8*	2	$Z_B = Z_R$	175 (x-c)	58(x-t), 194(y-t)	~ 13 (x-c)	282
	9	3	$Z_B = Z_R$	175 (x-t)		103 (x-t)	278
BV	13*	1	$Z_B = Z_R$ <sup>(note 1)</sup>	175 (x-t) <sup>(note 2)</sup>	76 (x-t), 23 (y-t)	~ 7 (y-c)	243
	14*	2	$Z_B = Z_R$	175 (x-c)	35 (x-t), 117 (y-t)	~ 7 (x-c)	230
	15	3	$Z_B = Z_R$	175 (x-t)		53 (x-t)	228

Notes same as Table 4.5

Figure 4.6 shows the adjusted combined stresses for all 12 cases in Table 4.6. The stresses are generally noticeably above 235 MPa. This, of course, indicates the presence of plasticity.

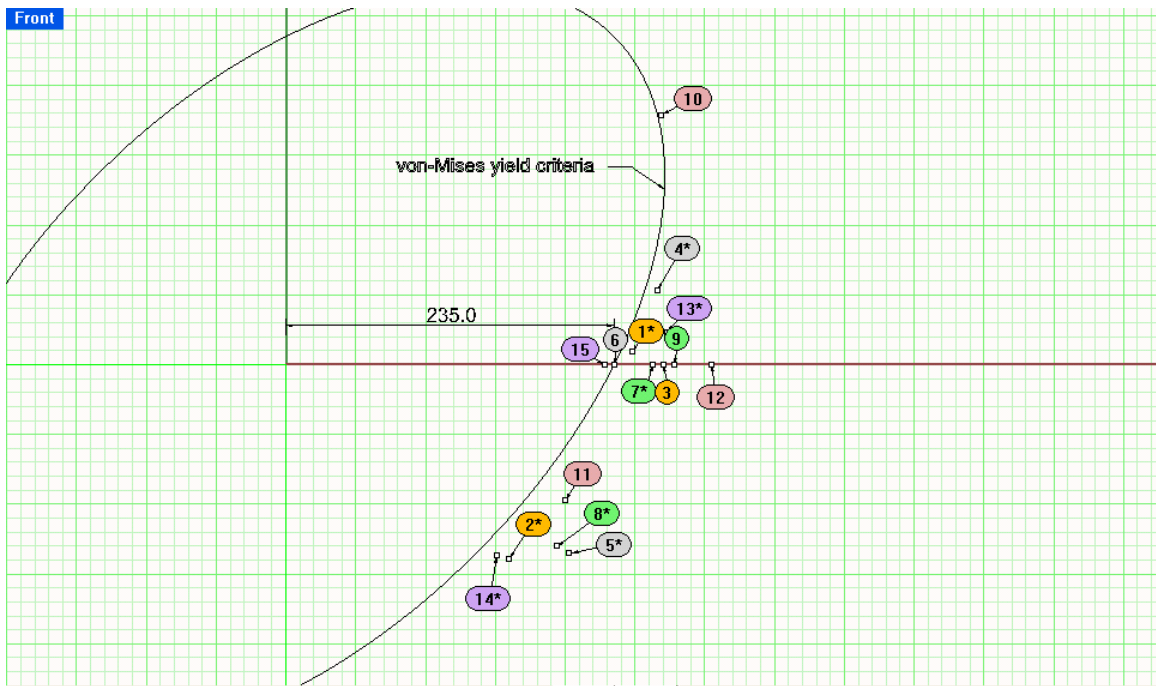


Figure 4.6: Adjusted Von-Mises Stress Calculations (cases in Table 4.6).

### 4.3 LRFD Ship Rules

Load and Resistance Factored Design (LRFD) is a design philosophy that has been widely adopted in civil and offshore structural design. The first North American LRFD implementation was the Ontario Highway Bridge Design Code (OHBD) released in 1979. Since that time, the LRFD concept has been widely implemented all around the world. The idea in LRFD is to employ calibrated load and strength factors to account for differences in likelihood and seriousness of loads and limit states. Structural components whose failure is more uncertain or more serious have higher load and strength factors. As more emphasis is placed in areas of greatest concern, the resulting design is more balanced. LRFD also provides a way of combining different types of loads on the basis of likelihood of simultaneous action. Calibration of the LRFD factors aims at optimizing structural performance, so that both safer and cheaper structures will result.

LRFD is not commonly used in commercial ship design. Only one classification society, BV, is using LRFD for ship commercial rules. In new BV rules edition April 2005 (entry in to force July 1<sup>st</sup> 2005), plate thickness is given with following formulae:

$$t = 14.9 \cdot C_a \cdot C_r \cdot s \cdot \sqrt{\gamma_r \cdot \gamma_m \frac{\gamma_s \cdot P_s + \gamma_w \cdot P_w}{\lambda_L \cdot \sigma_y}} \quad [\text{mm}] \quad (4.27)$$

Where

$\gamma_r$ ,  $\gamma_m$ ,  $\gamma_s$ , and  $\gamma_w$  are partial safety factors for resistance, material, still water and wave loads respectively and for a long plate without curvature  $C_a$  and  $C_r$  are equal to 1.  $\lambda_L$  is given by the formulae:

$$\lambda_L = \sqrt{1 - 0.95 \cdot \left(\gamma_m \cdot \frac{\sigma_{x1}}{\sigma_y}\right)^2 - 0.225 \cdot \gamma_m \cdot \frac{\sigma_{x1}}{\sigma_y}} \quad (4.28)$$

where  $\sigma_{x1}$  depends on hull girder loads.

It can be noted that equation (4.27) is quite similar to equation (4.1). Both use a combination of static and dynamic pressures and both use a factored working stress, so that combined stresses (von-Mises equivalent stresses) come close to yield. Equation (4.28) is essentially a von-Mises criterion. What is most notable in (4.27) is the use of partial safety factors. However, also of note is the use of a constant (14.9) which appears at first glance to be quite low. It seems that while some safety factors were added, the 'structural response' constant was lowered, possibly to leave the result unchanged; and certainly to confuse the issue of where and how safety factors have actually been incorporated in the requirements.

To determine the level of safety it is necessary to compare results. Table 4.7 shows the calculated stresses and equivalent stresses. The results are generally comparable with the previous values, although possibly somewhat lower than average.

**Table 4.7: Combined Stresses at the Locations Shown in Figure 4.2 for BV**

Rule Types and positions	Location	Assumptions	Hull girder stress [MPa]	Plate stress [MPa]	Ordinary frame stresses [MPa]	VM Total Stress [MPa]
BV	1	$Z_B = Z_R$ (note 1)	175 (x-t) (note 2)	76 (x-t), 23 (y-t)	~ 7 (y-c)	243
	2	$Z_B = Z_R$	175 (x-c)	35 (x-t), 117 (y-t)	~ 7 (x-c)	230
	3	$Z_B = Z_R$	175 (x-t)		53 (x-t)	228

same notes as for Table 4.5

#### 4.3.1 Quantitative Comparison between DnV Rules and BV Rules

An initial comparison of DnV and Bureau Veritas (BV) rules has been undertaken. Long flat plates are assumed (i.e., the aspect ratio factor  $C_a$  and the curvature factor  $C_s$  are 1). The material factor and resistance partial safety factors are multiplied by the constant in the BV rules, giving the plate thickness requirement:

$$t = 16.48 \cdot s \cdot \sqrt{\frac{\gamma_s \cdot P_s + \gamma_w \cdot P_w}{\lambda_L \cdot \sigma_y}} \text{ mm} \quad (4.29)$$

Using  $\gamma_m=1.02$  and a hull girder stress of 175, provides  $\lambda_L=0.5$ . This results in a ratio between DnV and BV allowable stresses of:

$$\frac{\sigma}{\lambda_L \cdot \sigma_y} = \frac{120}{0.5 \cdot 235} = 1.02. \quad (4.30)$$

If the same allowable stress is used for BV and DnV rules, the constant in BV plate thickness requirement becomes 16.3 and the thickness ratio for BV and DnV rules  $\frac{t_{BV}}{t_{DnV}} = 1.03$ .

Thus the difference in the plate thickness for the same load between BV and DnV is only 3%. Note also that the corrosion addition in DnV rules for the plates exposed to the sea water is  $t_k = 2.5$  mm, while the corrosion addition in BV rules for the plates exposed to the sea water is  $t_k = 1$  mm.

#### 4.4 Hull Girder Stresses

Longitudinal strength is a key aspect in any ship structural rules. As shown above, the local and global stresses combine and must be assessed together. The global stress in the bottom structure is the result of still water and wave bending moments. The still water bending moment depends on the ships loaded condition, and varies during the operation of a vessel. The design still water bending moment does not appear to contain a level of conservatism. The IACS Unified Requirements for Longitudinal Strength [UR S11] do not specify any specific value for the still water moment, but discuss how the value is to be calculated. The suggested calculations are supposed to consider various loading conditions, but are then just based on hydrostatics, without any factors of safety.

The IACS UR S11 forms the basis of the wave bending moments in all the various IACS member rule systems, including the new joint bulker and joint tanker rules. The wave bending moment is defined as:

$$M_W = .190 \cdot C_W \cdot L^2 \cdot B \cdot C_B \quad \text{hogging moment in kN-m} \quad (4.31)$$

$$M_W = .110 \cdot C_W \cdot L^2 \cdot B \cdot (C_B + 0.7) \quad \text{sagging moment in kN-m} \quad (4.32)$$

Where

$L$ : ship length in m

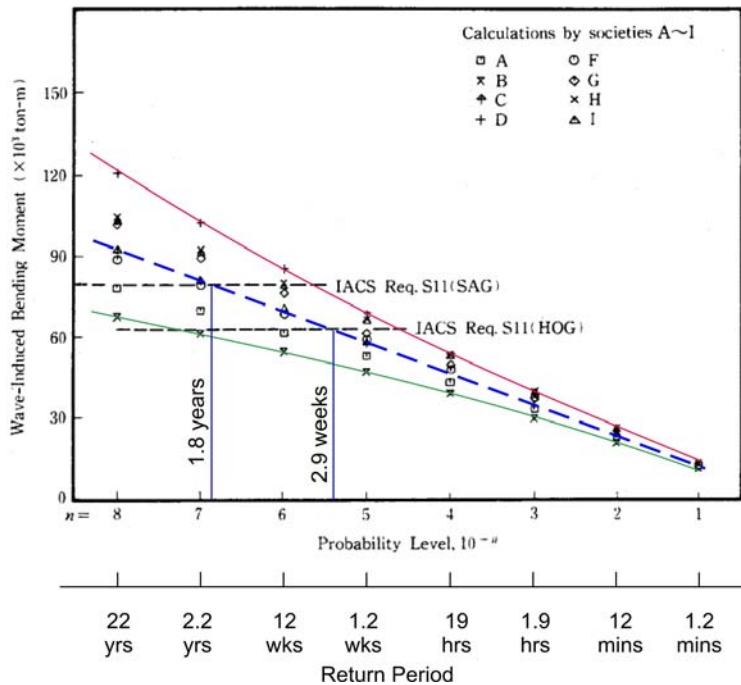
$B$ : ship breadth in m

$C_B$ : block coefficient

$C_W$ : wave height coefficient:  $C_W = 10.75 - \left[ \frac{300 - L}{100} \right]^{3/2}$  for  $90\text{m} < L < 300\text{m}$



It is interesting to review the origins of equations (4.31, 4.32) (see Nitta et. al. 1992). The IACS rule wave bending moment was essentially the mean values of the 11 member societies. An analysis of the probability level for the design wave is given by Nitta. Figure 4.7 shows an analysis of previous rule requirements, the IACS S11 requirements and an assessment of the corresponding return periods. There is a range of uncertainty associated with the probability of any given level of bending moments. Prior to unification, the various societies differed in their assessments of likelihood. The data in Figure 4.7 implies that the S11 wave hog bending moment has a likelihood in the range of  $10^{-7}$  to  $10^{-4}$ . This value is probability per wave encounter based on various class society estimates. Mean estimated values are also shown, and suggest a mean likelihood of  $10^{-5.4}$  (hog) and of  $10^{-6.9}$  (sag). These likelihood levels can also be presented as expected return periods (i.e., average time between events of this magnitude). This suggests mean return periods of 2.9 weeks (for hog BM) and 1.8 years (for sag SM). There is obviously considerable variability in the estimates, but it must be concluded that the values are not exceedingly rare.



**Figure 4.7: IACS Design Wave Bending Moments and Return Periods (see Nitta et. al. 1992)**

The IACS wave bending moment will now be compared to a simple static wave bending calculation, in which a ship is considered to be quasi-statically supported on the crest of a wave. For simplicity, a sinusoidal wave will be used. Traditionally, a design wave height of  $L/20$  was applied. As larger ships were brought into service, it was felt that the  $L/20$  formula was too conservative. A new formula of  $.607L^{0.5}$  was introduced. Figure 4.8 plots wave height vs. ship length for these two formulae. Also plotted is the value of  $C_w$  the IACS wave height coefficient, along with the formula  $2L^{0.3}$ , which very closely matches the  $C_w$  values. It is not explicit that the  $C_w$  value is meant to be the design wave height, but it is obviously closely related.

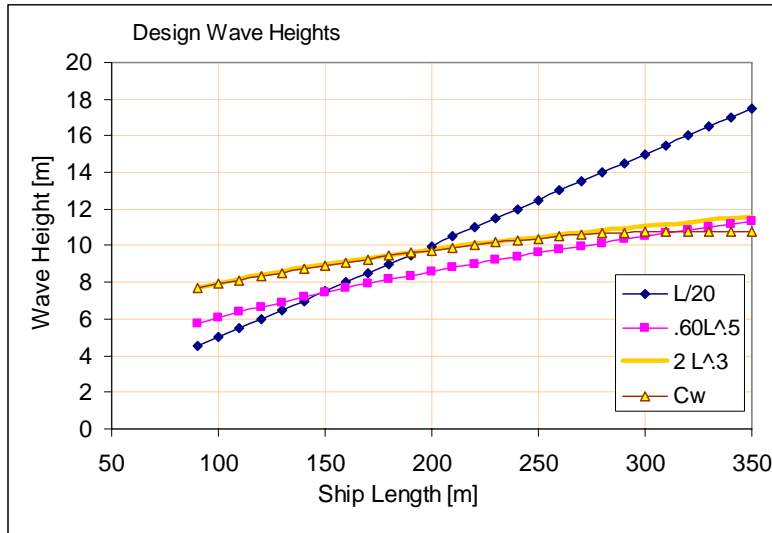


Figure 4.8: Comparison of Design Wave Heights

To calculate a quasi-static wave bending moment, consider the sketch shown in Figure 4.9. A sinusoidal wave applied to a block shaped ship (i.e.,  $C_B=1.0$ ) produced added buoyancy near midships and reduced buoyancy towards the ends. Considering just the forward part of the ship, symmetry results in an upward force located at the centroid of the additional buoyancy ( $x$  from the center) and an equal downward force at the centroid of the lost buoyancy ( $x$  from the end). This produces a net moment on the end of the ship with a magnitude of  $M=F c$ , where  $c = L/2 - 2x$ . This moment has to be balanced by the hull girder moment acting through midships from the other end of the ship.

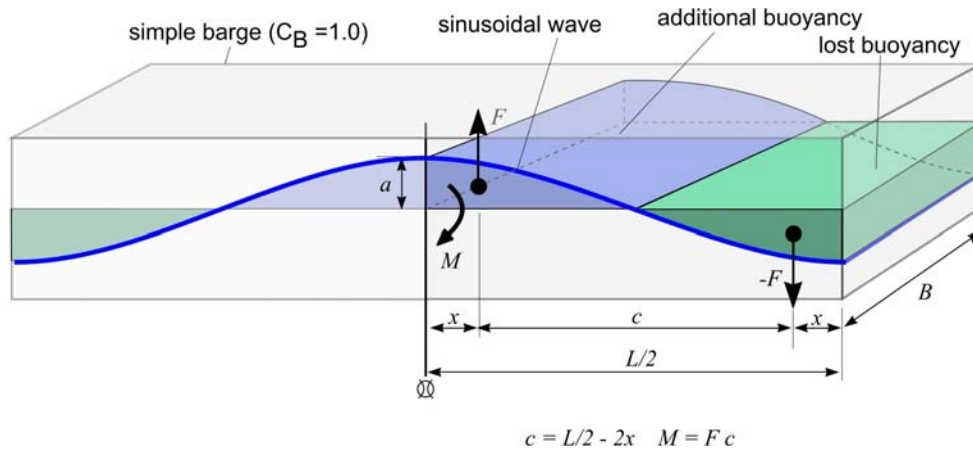


Figure 4.9: Simple Wave Bending Moment Calculation Concept

The calculation for the bending moment is as follows. The force  $F$  (in kN) is found as:

$$F = 9.8 \cdot 1.025 \cdot B \cdot a \cdot \int_0^{L/4} \cos\left(\frac{2\pi x}{L}\right) dx = \frac{10.0 \cdot B \cdot a \cdot L}{2\pi} = 1.60 \cdot B \cdot a \cdot L \quad (4.33)$$

The centroidal location  $x$  is found from:

$$x = \frac{\int_0^{L/4} x \cdot \cos\left(\frac{2\pi x}{L}\right) dx}{\int_0^{L/4} \cos\left(\frac{2\pi x}{L}\right) dx} = \frac{L(\pi - 2)}{4\pi} \quad (4.34)$$

From which  $c$  is found:

$$c = L/2 - 2 \frac{L(\pi - 2)}{4\pi} = .318L \quad (4.35)$$

From these the bending moment is:

$$M_W = 0.510 \cdot B \cdot a \cdot L^2 \quad (4.36)$$

The effect of the block coefficient can be taken into account by assuming all the lost volume is at the ends of the ship. This lets us reduce the effective length by  $C_B$ , thus introducing a  $C_B^2$  term;

$$M_W = 0.510 \cdot B \cdot a \cdot L^2 \cdot C_B^2 \quad (4.37)$$

If it is assumed that  $C_W$  is the design wave height, the amplitude  $a$  is  $C_W/2$ . If  $C_B^2$  is replaced by  $.88C_B$ , (.88 being a possible block coefficient for low-speed vessels), the wave bending moment becomes;

$$M_W = 0.224 \cdot C_W \cdot L^2 \cdot B \cdot C_B \quad (4.38)$$

This has the same form but is somewhat higher than the UR S11 formula shown in eqn (4.31). It is noted that  $C_W$  is larger than the  $.607L^{0.5}$  wave. For ships of 150m, the  $.607L^{0.5}$  wave is 83.5% of the  $C_W$  value. This can be included by setting the amplitude  $a$  to  $.417 C_W$ , which gives a wave bending moment of;

$$M_W = 0.19 \cdot C_W \cdot L^2 \cdot B \cdot C_B \quad (4.38)$$

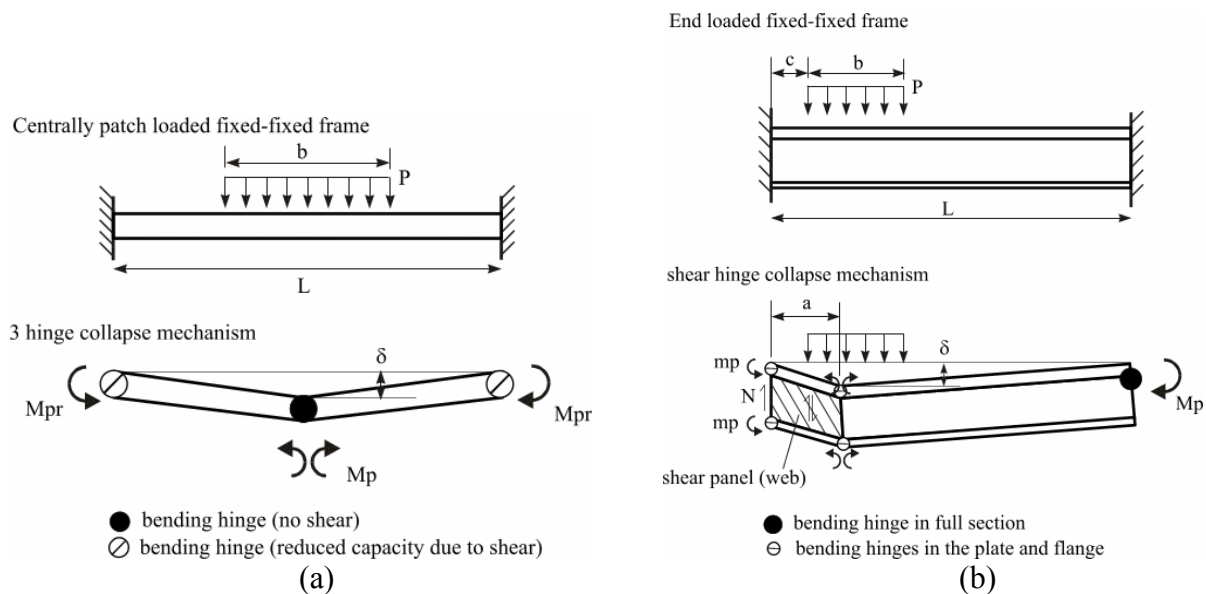
which is identical to the UR S11 formula. While several assumptions were made to arrive at this result, none of the assumptions would have introduced any significant level of conservatism. It can be concluded that the design wave bending moment that is found in virtually all rules is one that results from simple positioning of a ship on a wave. The design wave height is approximately 8m to 10m (for typical large vessels), which although large is certainly not extreme. [Parunov et. al. 2004] discusses the IACS wave bending moment, citing other publications and some original analysis and concludes that it is at least 25% below hydrodynamically calculated values for the North Atlantic.

### 4.5 Polar Class Rules

The IACS Unified Requirements for Polar Class Ships I2 represent a different approach to ship design. The UR I2 requirements were developed through a collaborative process involving both IACS member societies and representatives from several countries with ice class ship rules. There are several aspects of the UR I2 which are not found in conventional ship rules. One key feature of the UR I2 is the range of ice classes. The higher classes are intended for the most severe ice conditions, while the lower classes are intended only for light ice conditions. This concept is something like the difference between ocean-going and inland water vessels, relating loads to operating conditions. There would be greater similarity of concept if ocean going ships were designed with different classes with the class reflecting the severity of the intended operational sea states.

One reason for the existence of various ice classes is the wide range of possible ice loads. The highest classes experience ice load that are at least an order of magnitude higher than the lower ice classes. It would be unreasonable to design all ice-going ships for the worst sea ice conditions, analogously to the need to design ocean going ships for North-Atlantic seas.

In the UR I2 rules, the design equations are based on plastic capacity of the plate and frames, along with a conservative specification of the loads. For example, to design a transverse frame in the ice belt, the two limit states shown in Figure 4.10 are considered. It is important to note that both limit states involve an interaction between bending and shear, and so both section modulus and shear area are included in both limit states. Table 4.8 shows one of the UR I2 rules, that for a transverse frame. (Daley 2002) gives the derivation of these limit states, and (Daley and Kendrick 2000) gives a broader discussion of the rule formulations.



**Figure 4.10: Bending (a) and Shear (b) Limit States Checked in UR I2**

**Table 4.8: Extract from IACS UR I2 – Structural Rules for Polar Ships**

I2.6.3 The minimum plastic section modulus of the plate/stiffener combination,  $Z_{pm}$ , is to be the greater calculated on the basis of two load conditions: a) ice load acting at the midspan of the main frame, and b) the ice load acting near a support. The  $A_1$  parameter in Equation 19 reflects the two conditions:

$$Z_{pm} = 100^3 LL Y s (AF PPF_m P_{avg})^* a * A_1 * KA / (4 * \sigma_y) \quad [cm^3] \quad [Equation 19]$$

where

$LL$  = length of loaded portion of span

= lesser of  $a$  and  $b$  [m]

$a$  = main frame span [m]

$b$  = height of design ice load patch from Equation 12 or 14 [m]

$Y = 1 - 0.5 * (LL / a)$

$s$  = main frame spacing [m]

$AF$  = Hull Area Factor from Table 3

$PPF_m$  = Peak Pressure Factor from Table 2

$P_{avg}$  = average pressure within load patch according to Equation 15 [MPa]

$\sigma_y$  = minimum upper yield stress of the material [N/mm<sup>2</sup>]

$KA = 1 / \cos(\theta)$

$\theta$  = angle between the plane of the web and a perpendicular to the shell plating at the midspan of the section, if  $\theta \leq 15$  deg,  $KA$  to be taken as 1.0

$A_1$  = maximum of

$A_{1A} = 1 / (1 + j / 2 + k_w * j / 2 * [(1 - a_1^2)^{0.5} - 1])$

$A_{1B} = (1 - 1 / (2 * a_1 * Y)) / (0.275 + 1.44 * k_z^{0.7})$

$a_1 = A_m / A_{mFIT}$

$A_m$  = minimum shear area for main frame [cm<sup>2</sup>]

$A_{mFIT}$  = fitted shear area of main frame [cm<sup>2</sup>]

$k_w = 1 / (1 + 2 * A_f / A_{mFIT})$

$A_f$  = flange area of main frame web as fitted [cm<sup>2</sup>]

$k_z = Z_p / Z_p$

$Z_p$  = sum of individual plastic section moduli of flange and shell plate as fitted [cm<sup>3</sup>]

=  $w_f * t_f^2 / 4 + b_{eff} * t_{net}^2 / 4$

$w_f$  = width of flange [cm]

$Z_p$  = plastic section modulus of main frame as fitted [cm<sup>3</sup>]

The IACS UR I2 structural rules contain a number of features that are of note:

- Scantling formulations are all based on explicitly derived plastic limit states. This is intended to make the rules more transparent and amenable to sensible revision as new knowledge becomes available. The formulations attempt to reflect realistic structural behaviour, with interaction effects and a system-level view.
- The rules consider implicitly consider both serviceability and safety limit states. The formulations for scantling requirements are based on plastic limit states which, on one hand, reflect the point at which deformations will begin to grow large (i.e., the limit of the structures serviceable condition). As well, the formulations and stability checks tend to ensure that the sections will have significant plastic reserve, this assuring adequate ultimate strength.

- The rules do not present the design situation in probabilistic terms. Rather, the design point is meant to be a capacity specification. While ice is highly variable, a ship is a vehicle and is operated with intention. Rather than thinking of ice loads as a random event, blindly applied to the ship, the rules see loads as being mainly the result of operational decisions, where the vessel's master makes a choice to enter increasingly severe ice. The class of the vessel is an expression of the specified capability of the vessel. It is important for the master to have a clear and specific understanding of the structural capability of the vessel.

The IACS Polar Rules come from a different tradition than most ship rules. The rules are calibrated on earlier rules from Canada, Russia and Finland-Sweden. The world's ice class rules are relatively recent, and have evolved during an intense period of full scale testing and research in the 1980s and 90s, when arctic resource developments were beginning. Not only do the rules contain several unique features, but as well, the process for developing the rules was unique. The Polar Rules were the result of broad international collaboration, with involvement from classification societies, government, the shipping industry, and specialists from naval architectural firms and universities. The effort was lengthy (10 yrs+), and was intended not only to capture the state-of-the-art but to improve it. However, the key components of the rule system are still not completely separable, with the factors of safety being buried within a number of implicit assumptions.

## 5. COMPARISON AND ANALYSIS

Section 4 has presented general comparisons of approaches under various rule systems. It has been shown that most of these are very similar in their general design. However, no two rule systems (including the very recent Joint Bulker and Tanker Rules) are identical in the equations, constants, and coefficients that they use. Further, more detailed analyses of a range of potential applications have therefore been undertaken in order to compare actual outcomes.

This work has also served to explore several other issues that have been raised in previous sections – notably the location and magnitude of safety factors within the prescribed approaches.

### 5.1 Concept Comparison

The aim of this task is to explore and compare different classification society rule concepts, with a focus on the following features:

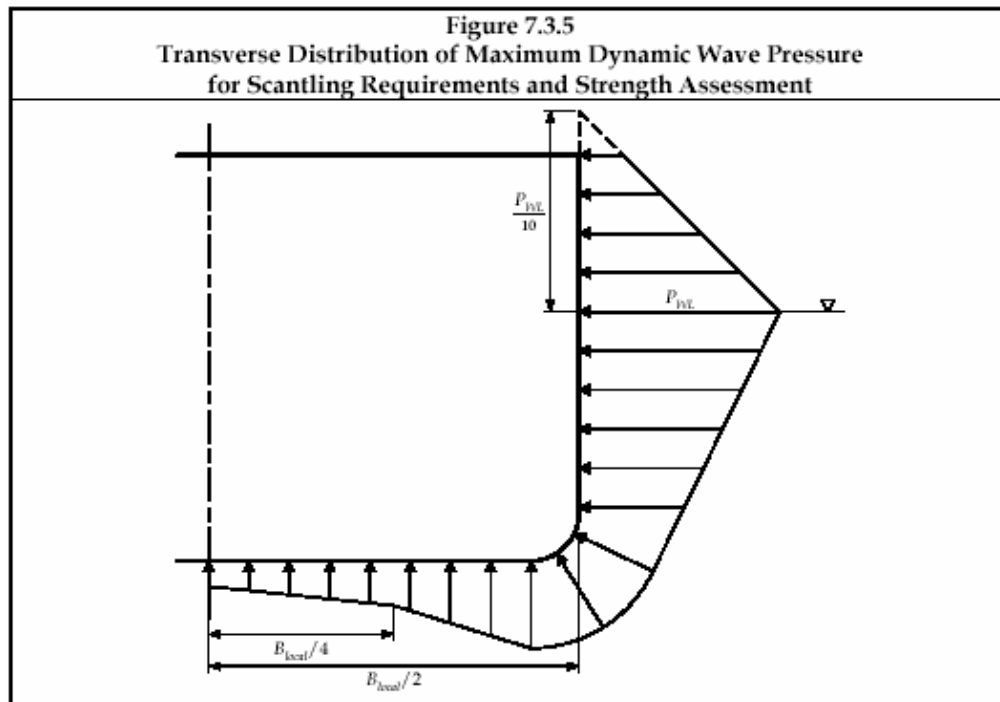
- Definition of wave pressure;
- Required minima;
- Corrosion additions;
- Hull girder requirements; and
- Rule simplicity.

#### 5.1.1 Wave Pressures

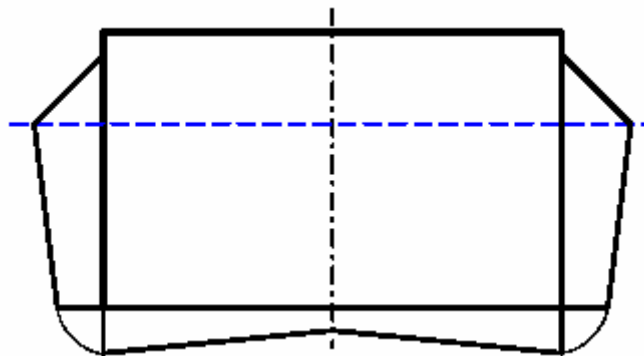
As noted in Section 4, in the majority of modern ship structural rules, scantling requirements are given by “mechanics-based” formulas with reference to the design loads.

The design load on a structural member is calculated by adding hydrostatic and wave pressures for the position under consideration. The influence of hull girder bending is typically taken into account in the allowable stresses for local response. In this way the biaxial state of stress is considered. Other complicating stress effects, such as vertical shear, torsion, misalignment and many others are not considered.

The rule sets that have been examined use different approaches for calculating wave pressure. In the most recent ship commercial rules, including the Joint Tanker Rules (JTR) and Joint Bulker Project (JBP), the wave design pressure varies across the ship bottom. This contrasts with the latest edition of ABS rules for tankers (ABS was involved in developing JTR) and BV rules (BV was involved in developing JBP), where the wave pressure is considered constant across the bottom (Figures 5.1 to 5.4).

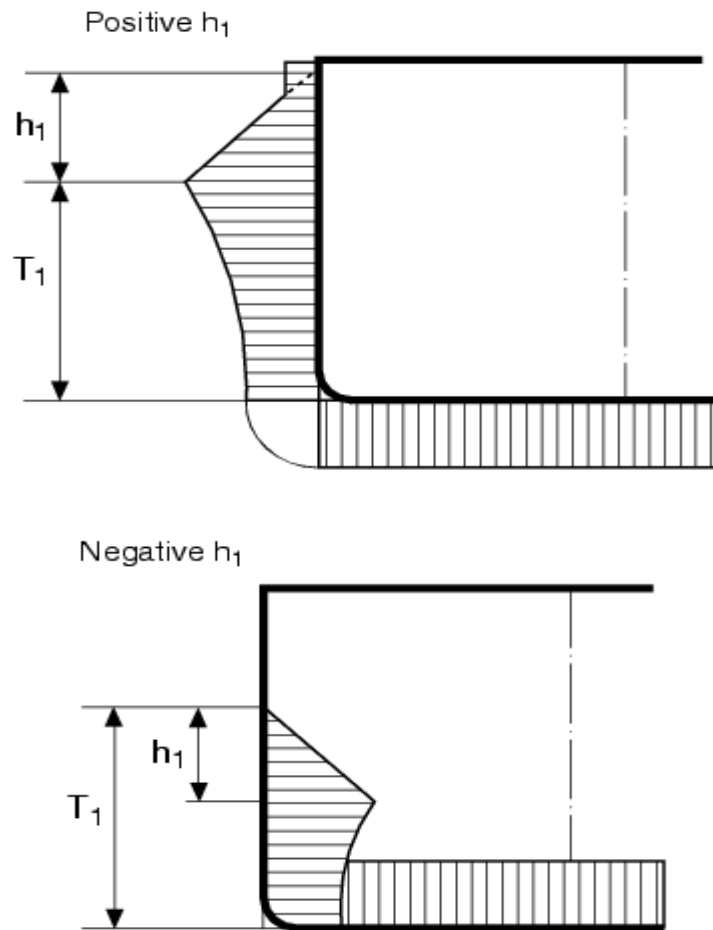


**Figure 5.1: JTR Wave Pressures**

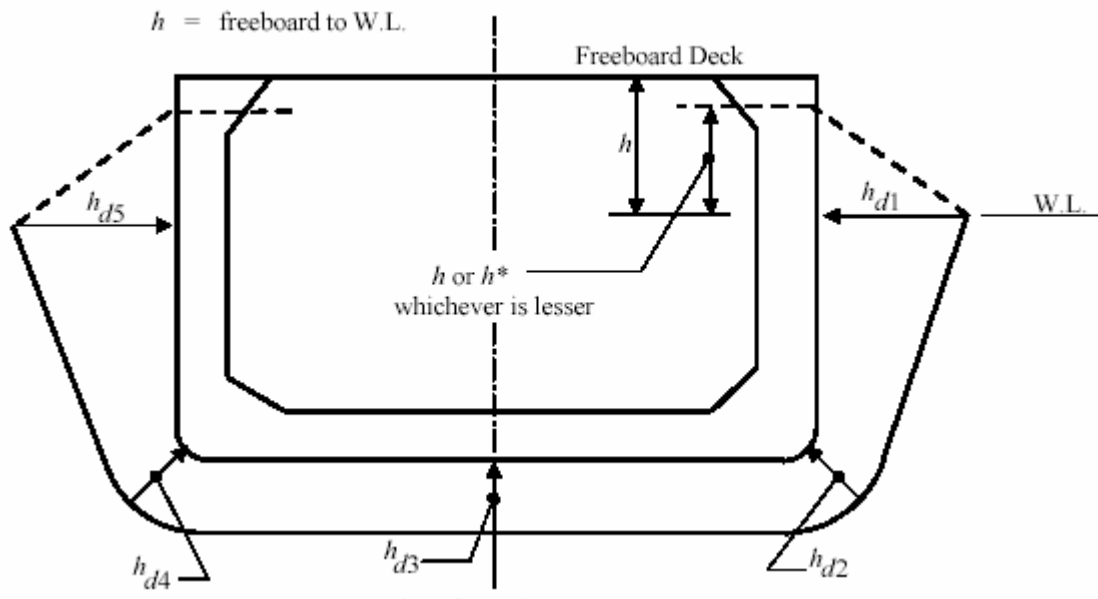


**Figure 5.2: JBP Wave Pressures**





**Figure 5.3: BV Wave Pressures**



**Figure 5.4: ABS Rules for Oil Carriers over 150m Wave Pressures**

In order to make quantitative comparisons of different rule requirements, wave pressure has been calculated for a 1A1 (unrestricted navigation) vessel with following dimensions:

- L<sub>bp</sub> = 200 m
- B = 30.8 m
- T = 10.3 m
- D = 16.2 m

where L<sub>bp</sub> is vessel length between perpendiculars, B is vessel beam, T is vessel draft and D is vessel depth to the main deck. Calculation results are presented in Table 5.1.

**Table 5.1: Wave Pressure Calculations**

Position	Bottom at CL	Bottom at B/4	Bottom at B/2	Side shell at draft
Hydrostatic pressure KN/m <sup>2</sup>	103.13	103.13	103.13	0.00
JTR dynamic pressure	26.24	34.33	83.11	125.09
<b>total pressure JTR</b>	<b>129.37</b>	<b>137.46</b>	<b>186.24</b>	<b>125.09</b>
JBP dynamic pressure	33.04	49.56	66.08	99.11
<b>Total Pressure JBP</b>	<b>136.17</b>	<b>152.69</b>	<b>169.21</b>	<b>99.11</b>
BV dynamic pressure	43.27	43.27	43.27	59.71
BV dynamic pressure x PSF	51.92	51.92	51.92	71.65
<b>Total Pressure BV</b>	<b>155.05</b>	<b>155.05</b>	<b>155.05</b>	<b>71.65</b>
GL dynamic pressure	29.69	29.69	29.69	59.38
<b>Total Pressure GL</b>	<b>132.82</b>	<b>132.82</b>	<b>132.82</b>	<b>59.38</b>

**Table 5.1: Wave Pressure Calculations (continued)**

Ship Dimensions	Ship length (m)	Beam (m)	Draft (m)	Ship depth (m)
ABS rules for specific ship types over 150m in length	40.00	46.67	53.33	133.33
<b>Total Pressure ABS</b>	<b>143.13</b>	<b>149.80</b>	<b>156.46</b>	<b>133.33</b>
DnV dynamic pressure	22.87	22.87	32.69	45.05
<b>DnV total pressure</b>	<b>126</b>	<b>126</b>	<b>135.82</b>	<b>45.05</b>

Based on the results obtained, the following issues can be identified:

- Requirements for the design wave pressure vary considerably between different classification societies (23 to 53 kPa for the bottom centerline in examples shown);
- Requirements for the design wave pressure have not yet been harmonized for the different ship types; different requirements in JTR and JBP for example may create difficulties in designing an OBO carrier;
- Calculated values for the wave pressure on the ship side at the designed draft show significant difference (difference between ABS tanker rules and DnV rules are a factor of 3); and
- Total design pressures do not appear to include a significant factor of safety. The calculated total pressure at the bottom CL and B/4 position can be easily attained if the ship's draft were to be deeper than the design condition (which can occur in the damaged condition).

Based on the level of variability, it is questionable whether any or all of the calculated wave pressures are intended to be “real”. They all have to be used in combination with other selected rule features such as stress requirements, minima, etc., and should not form the basis for direct calculations (e.g., FEA) or for the design of other components.

### 5.1.2 Minima

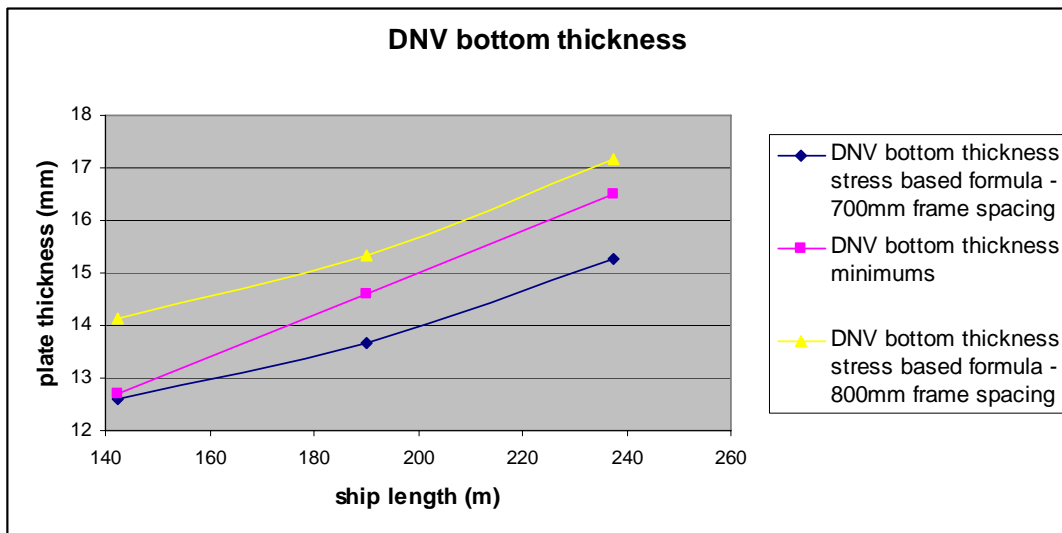
Minimum scantling requirements are generally prescriptive. They do not relate to explicit loads and are typically found as adjunct requirements in “mechanics-based” (“load-stress based”) rules. Somewhat paradoxically, older, empirical rules tended not to have minima. They appear to have been introduced to restrict designers’ abilities to manipulate the other formulae, and imply a lack of confidence both in the formulae themselves and in the competence and understanding of the user community.

Minima are to be applied irrespective of all other requirements. Hence thickness below the minimum is not allowed. Requirements are usually expressed in the following format:

$$t_{\min} = A + B \cdot L + (C \cdot s) \quad \text{mm}$$

where  $t_{\min}$  is minimum net scantling,  
 A, B and C are constants  
 L is ship length in m  
 s is frame spacing in m

The frame spacing  $s$  is shown in brackets because it is not included in most structural standards, where the minimum thickness is a function of ship length only. The consequence of this is to encourage designers to increase frame spacing, to avoid having the minimum requirements determine the scantlings. This is illustrated in Figure 5.5 for DnV bottom plating thickness.



**Figure 5.5: Bottom Plating, DnV Rules**

Minimum requirements for bottom plating for a 150m ship with 800mm frame spacing according to different class society rules is given in Table 5.2.

**Table 5.2: Comparison of Minima**

Minimum thickness calculation bottom plating	
Ship length (m)	150
Frame spacing (m)	0.8
JTR	11
JBP	12.5
BV	12.7
DnV	13
GL	12.25

Table 5.3 shows how minimum requirements are specified in different classification societies and how minimums are correlated with normal scantling requirements.

**Table 5.3: Correlation between Minimum and Normal Scantling Requirements**

<b>Rule Set</b>	<b>Determinant</b>
ABS General Cargo Ships	Empirical formulas for scantling requirements, two formulas, “greater of” system, minimum requirements for bottom plating
ABS Specific Ship Type	Stress based formulas for scantling requirements, three formulae: one formula dealing with buckling, “greater of” system, no minimum requirements
DnV	Stress based formula for scantling requirement, additional buckling check, one parameter (length) minimum requirements present
BV	Stress based formula for scantling requirement, additional buckling check, two parameter (length and frame spacing) minimum requirements present
JTR	Stress based formula for scantling requirement, additional buckling check, one parameter (length) minimum requirements present
JBP	Stress based formula for scantling requirement, additional buckling check, one parameter (length) minimum requirements present
LR Naval Rules for S1 type ships	Empirical formulas for scantling requirements, two formulas, “greater of” system, no minimum requirements
GL	Stress based formula for scantling requirement, two formulas, “greater of” system, additional buckling check , one parameter (length) minimum requirements present

### 5.1.3 Corrosion Additions

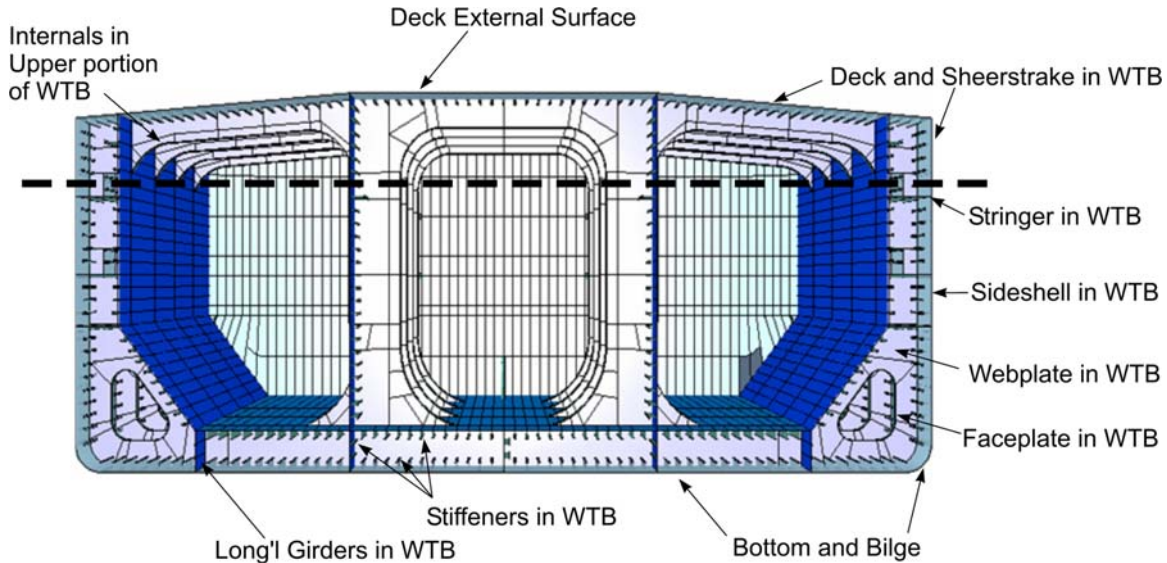
Recent commercial ship structural rules use the ‘net thickness’ approach in which gross scantlings are obtained by adding a corrosion addition to the net scantlings derived from structural strength requirements.

Corrosion additions in different rule sets for the bottom plating for the ballast tank in the double bottom are given in following table:

**Table 5.4: Comparison of Corrosion Additions**

<b>Rule Set</b>	<b>Corrosion Addition for Double Bottom Ballast Tank Bottom Plating</b>
JBP	2.5 mm
JTR	3 mm
BV	If gross plating thickness is > 10 mm corrosion addition is 1.5 mm If gross plating thickness is ≤ 10mm corrosion addition is smaller of: 20% of gross scantling thickness and 1.5 mm
DnV	2 mm
GL	If net plating thickness is > 10 mm corrosion addition is 10% of net plating thickness + 0.5mm If net plating thickness is ≤ 10mm corrosion addition is 1.5 mm
ABS rules for tankers over 150m in length	1 mm
ABS rules for bulk carriers over 150m in length	1 mm
LR Naval Rules	0.5 mm

In the recent “Update on IACS Common Structural Rules (JTR and JBP)” presentation (October 31 in Beijing), corrosion additions were identified as an issue that requires harmonization between the two systems in the short term. Ship structural members where the common corrosion additions will be applied in JTR and JBP are given in Figure 5.6.



**Figure 5.6: Members for which Common Corrosion Addition will be Applied (JTR and JBP)**

The declared principles for harmonization are:

- Use the JBP ‘two surface approach’ for determination of wastage allowance and consequently corrosion addition.
- Use the JTR method for rounding.

An explanation of how corrosion additions have been determined in the JBP is found in the “Technical Background on Corrosion Addition” document, published together with latest edition of the JBP rules. A summary of the procedure is given below:

1. 600000 thickness measurement records were collected from single skin tankers and bulk carriers of ages 5 to 27 years;
2. from this measured data, data for tankers and bulk carriers complying with 73/78 MARPOL requirements and existing IACS URs was selected;
3. a corrosion propagation model based on probabilistic theory for each structural member was developed;
4. corrosion diminution was estimated at the cumulative probability of 95% for 20 years using the corrosion propagation model;
5. the corrosion environment to which each structural member is exposed was classified, and corrosion rates in all corrosion environments using the estimated corrosion diminution for each structural member was calculated; and
6. corrosion additions were determined for each structural member and corrosion environment.



While this approach appears rational and exhaustive, it does not necessarily validate the use of these (or any) corrosion additions as structural design requirements. If net thickness is accepted as representing the minimum acceptable value, owners could still be free to use a variety of techniques or maintaining this; including the use of advanced coatings, aggressive inspection and repair regimes, etc. Essentially this appears to be the approach accepted in rule systems such as the LR (and other) naval ship rules and high speed craft rules.

#### 5.1.4 Hull Girder Requirements

Permissible wave bending moments were unified in an earlier IACS Unified Requirement (UR S11), and the value is the same for all the rules examined. Permissible still water bending moment is different only in the JTR. For a ship with following dimensions:

Ship length (m)	Beam (m)	Draft (m)	Ship depth (m)	Block coefficient C <sub>b</sub>	Wave coefficient C <sub>w</sub>
200.00	30.77	10.26	16.19	0.75	9.75

The permissible still water bending moment for sagging is given in Table 5.5.

**Table 5.5: Permissible Still Water Bending Moment; Different Rule Sets**

	M <sub>sw-perm_sag</sub> (KNm)
JTR	902190.00
JBP	1131000.00
BV	1131000.00
DnV	1131000.00

Vertical hull girder ultimate bending capacity also differs from rule set to rule set. Formulae and calculated values for the ship with dimensions noted above are given in Table 5.6:

**Table 5.6: Ultimate Hull Girder Bending Capacity – Different Rule Sets**

Rule set	Formulae $\leq \mu$ (vertical hull girder bending capacity)	Value (KNm)
JTR	$1.1 \cdot (1 \cdot M_{sw-sag} + 1.3 \cdot M_{w-sag})$	3729429.00
JBP	$1.1 \cdot (1 \cdot M_{sw-sag} + 1.2 \cdot M_{w-sag})$	3770580.00
BV	$1.03 \cdot 1.02 \cdot (1 \cdot M_{sw-sag} + 1.1 \cdot M_{w-sag})$	3400161.84
DnV	$M_{sw-sag} + M_{w-sag}$	3045000.00

The JTR, JBP and BV rules use an LRFD approach – load and resistance factored design rules for hull ultimate bending capacity calculations. The DnV rules examined are the 1998 edition. No partial safety factors are used.

### 5.1.5 Rule Simplicity

Rules that are easy to understand and apply will normally lead to fewer errors in application than those which are more complex. In an attempt to evaluate how user-friendly different rule sets are, a comparison of rule simplicity has been carried out. As an example of different rule approaches, a comparison has been made of the data required (or parameters used) for plating thickness calculation in the JTR, BV and LR Naval Rules (for S1 type of ships). Results are presented in matrix format in Table 5.7.

**Table 5.7: Rule Simplicity Comparison**

No	<b>JTR Data required to calculate plating thickness</b>	<b>BV Data required to calculate plating thickness</b>	<b>LR Naval Rules S1 Data required to calculate plating thickness</b>
1.	Frame spacing	Frame spacing	Frame spacing
2.	Combined static and dynamic lateral pressure	Static and dynamic lateral pressure	<i>Not Required (" shaded cells)</i>
3.	Yield strength of material	Yield strength of material	Yield strength of material
4.	Aspect ratio	Aspect ratio	
5.	Web spacing	Web spacing	
6.	Coefficient $\alpha$	Partial safety factors	
7.	Coefficient $\beta$		
8.	Still water bending moment	Still water bending moment	Still water bending moment
9.	Wave bending moment	Wave bending moment	Wave bending moment
10.	Cross-section Section-Modulus	Cross-section Section-Modulus	Cross-section Section-Modulus
11.	Ship length	Ship length	Ship length
12.	Ship beam	Ship beam	Ship beam
13.	Ship draft	Ship draft	Ship draft
14.	Block coefficient	Block coefficient	Block coefficient
15.	Wave coefficient	Wave coefficient	Wave coefficient
16.	Roll angle		
17.	Natural roll period		
18.	Roll radius of gyration		
19.	Transverse metacentric height		

These comparisons raise obvious questions of safety and optimization; i.e., do the complex formulations of the JTR lead to safer design than the simpler LR NSR, or conversely are the additional parameters in the JTR needed to address a wider range of possible ship configurations? In order to answer these questions fully it would be necessary to determine final outcomes for a variety of ships under the various approaches, which has been undertaken in part in Section 5.2. However, the issue of simplicity (complexity) will be discussed again in Section 6.

## 5.2 Detailed Analysis

In order to compare actual outcomes under various design standards, a set of structural design cases has been developed and analyzed. The basis for comparison has been mid-ship cross section weight for:

- Three general cargo ships under 90m in length;
- Three general cargo ships over 90m in length;
- Three bulk carriers over 150m in length; and
- Three tankers over 150m in length.

The standards used to determine cross-section scantlings include LR Naval Rules, DnV, GL, BV, JTR, and JBP. For the purpose of this task, local effects due to cargo loads were ignored, and rule values for still water and wave hull girder bending moments were used.

The weight calculated was for weight per meter length of the plating and ordinary stiffeners up to and including main deck, for the section outside the hatch openings. Structural weight optimization was only carried out to a very limited extent. In addition to weight comparison, investigations were also undertaken into of the rule set sensitivity to aspect ratio, stiffener spacing and stiffener orientation (transverse or longitudinal).

### 5.2.1 General cargo carriers under 90m in length

Scantlings were calculated for the general cargo ships with dimensions as shown in Table 5.8. All the ships considered are classed 1A1 General Cargo Carrier, and have a single side and double bottom, with longitudinal framing system. The cross-section weight was calculated for required net scantlings.

**Table 5.8: Small General Cargo Ships**

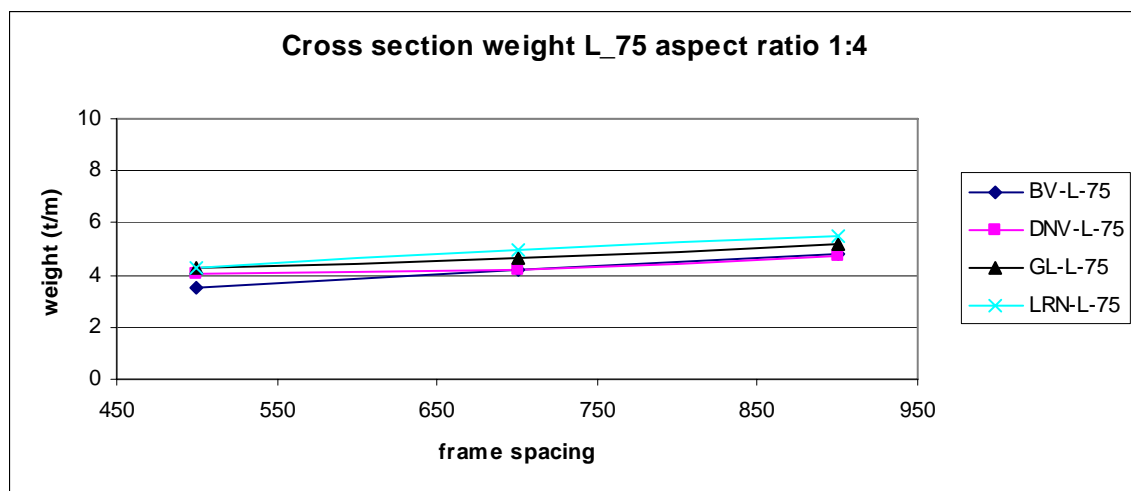
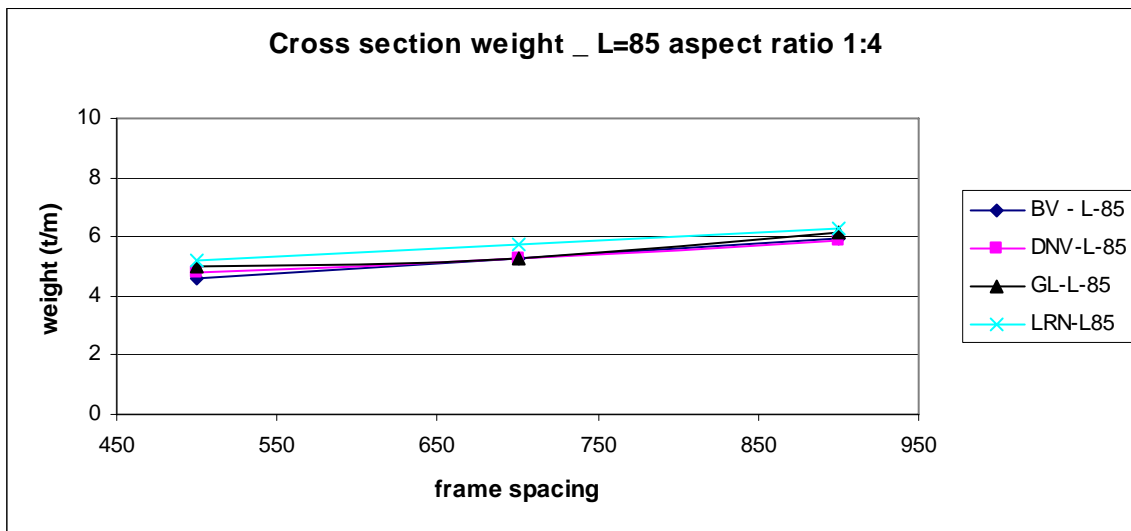
<b>Ship Particulars</b>	<b>Ship No 1.</b>	<b>Ship No 2.</b>	<b>Ship No 3.</b>
Loa (m)	89.00	69.00	79.00
Lbp(m)	84.28	65.34	74.81
B (m)	13.88	10.76	12.32
D (m)	7.44	5.77	6.60
T (m)	5.90	4.57	5.24
Cb	0.71	0.71	0.71

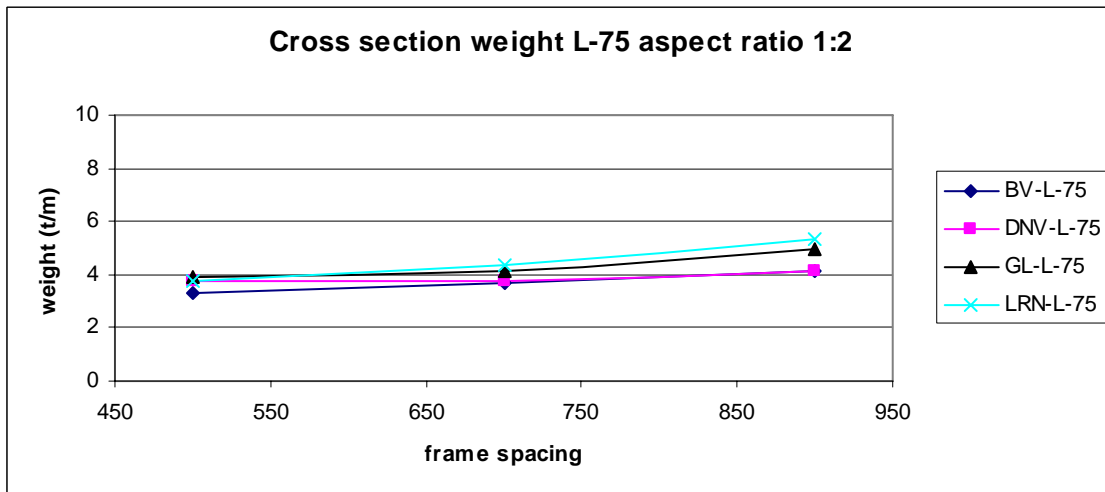
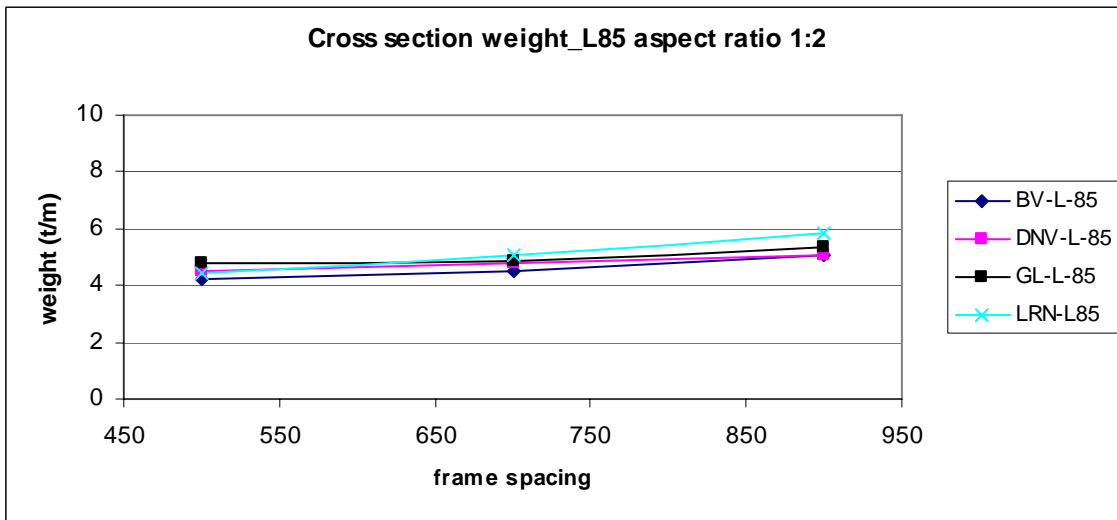
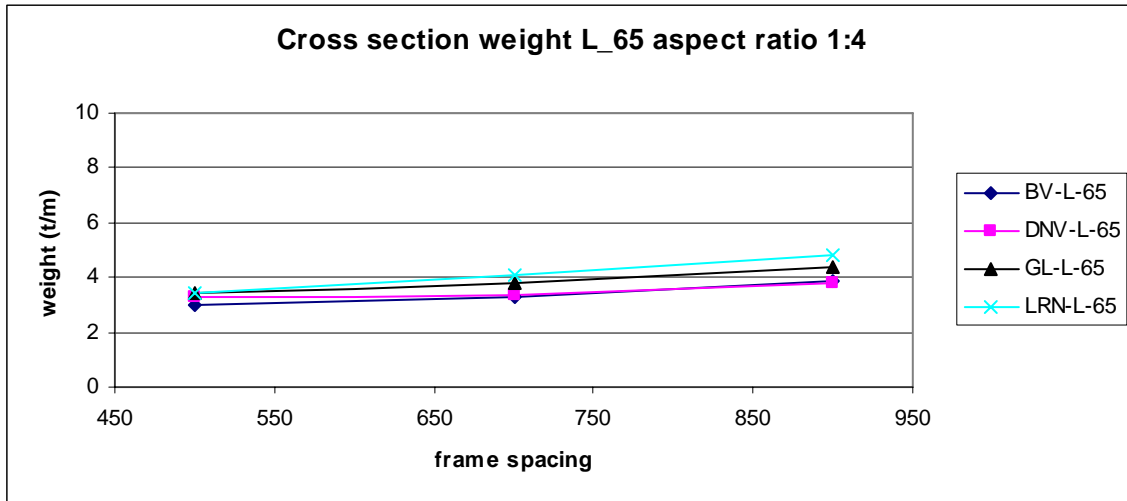
Rule sets used for comparison analysis were BV, DnV, GL and LR Naval Rules (S2 and S3 type of ships). Cross-section scantlings and consequently cross section weight were determined using the following software packages:

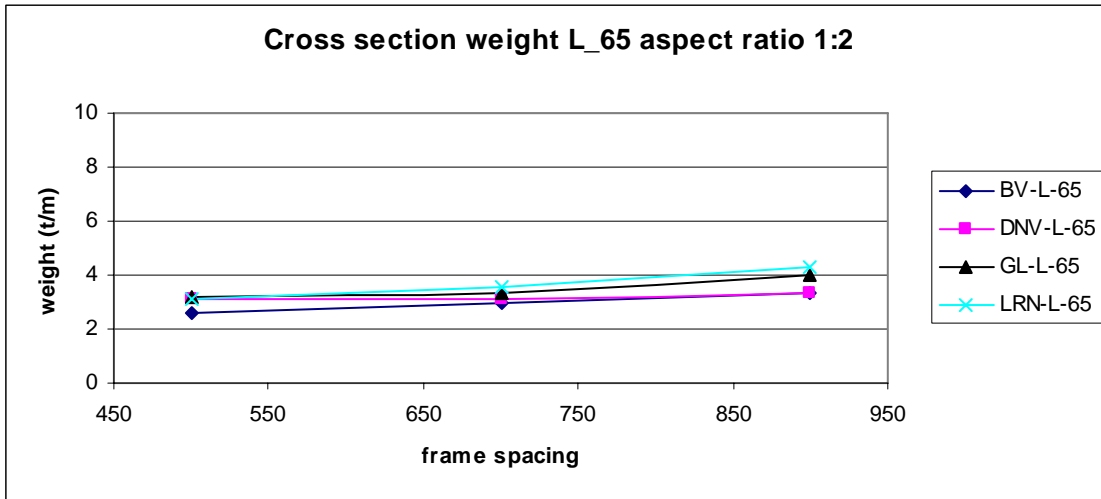
- NAUTICUS – DnV
- MARS – BV
- POSEIDON – GL

LR Naval Rules scantlings were calculated using Microsoft Excel™ spreadsheets.

Resulting cross-section weights per meter length for the different rule sets, different frame spacing and aspect ratios are presented in the following figures.

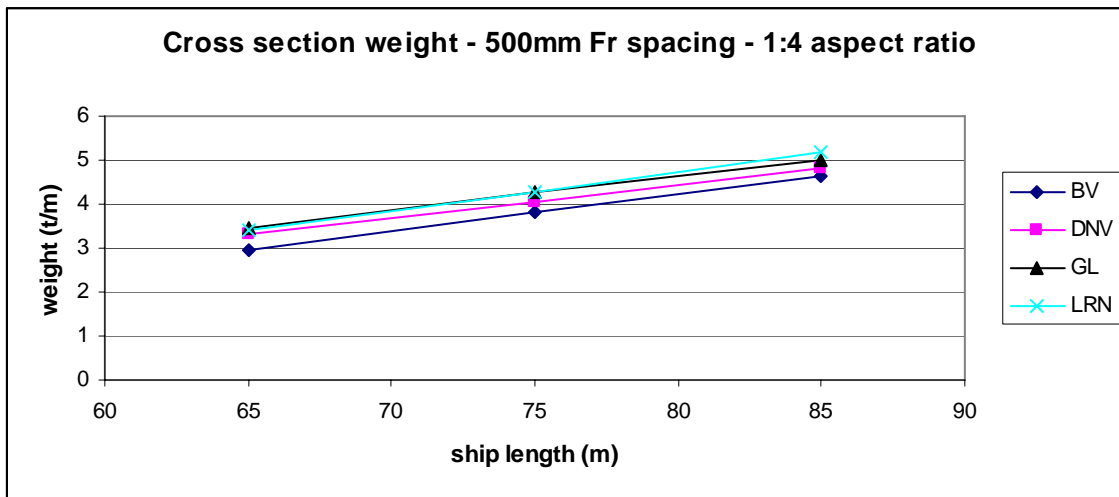


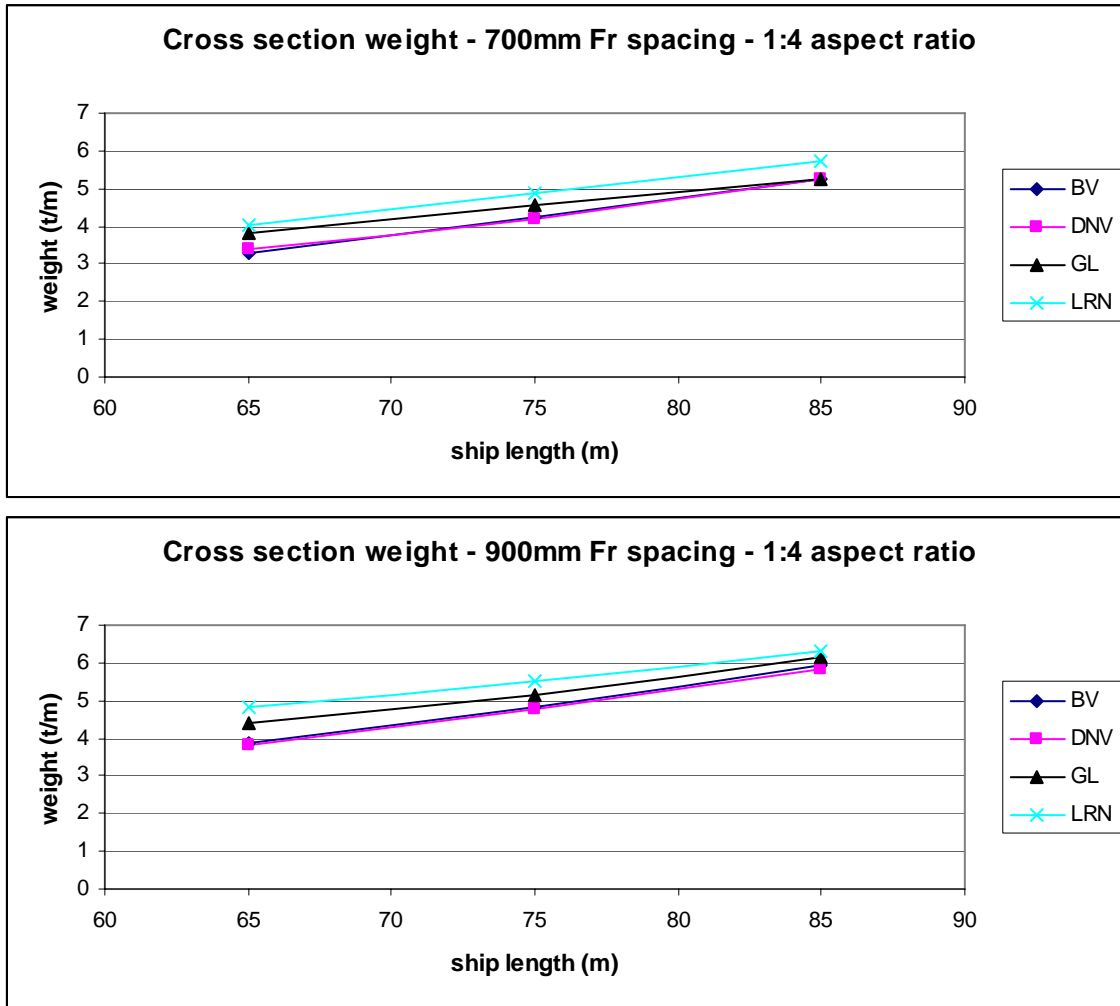




**Figure 5.7: Cross-section Weights, General Cargo Carriers under 90m**

The change of the cross-section weight as a function of ship length is shown in Figure 5.8.





**Figure 5.8: Cross-section Weights General Cargo Carriers under 90m as Function of Ship Length**

The sensitivity of scantlings to panel aspect ratio was investigated using aspect ratios of 1:1, 1:2 and 1:4 and frame spacing 500 and 900 mm. Only the weight of a secondary structure (ordinary frames) and plating was considered.

Results for the 85m long ship are shown in Figure 5.9.

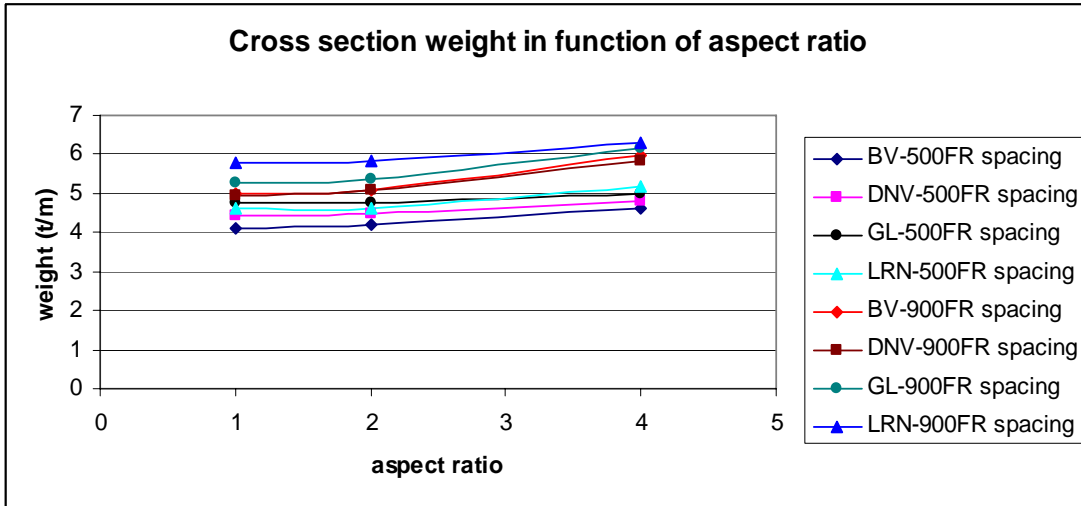


Figure 5.9: Cross-section Weights as Function of Aspect Ratio

Results shown in the above figure do not include weights due to web frames or other major structure, the focus of the analysis being the plating and framing.

Additional comparisons have been made for the Commercial rule sets (BV, GL and DnV) when transverse framing is used. Results for the ship with 85m length are shown in the following figure, and include only plating.

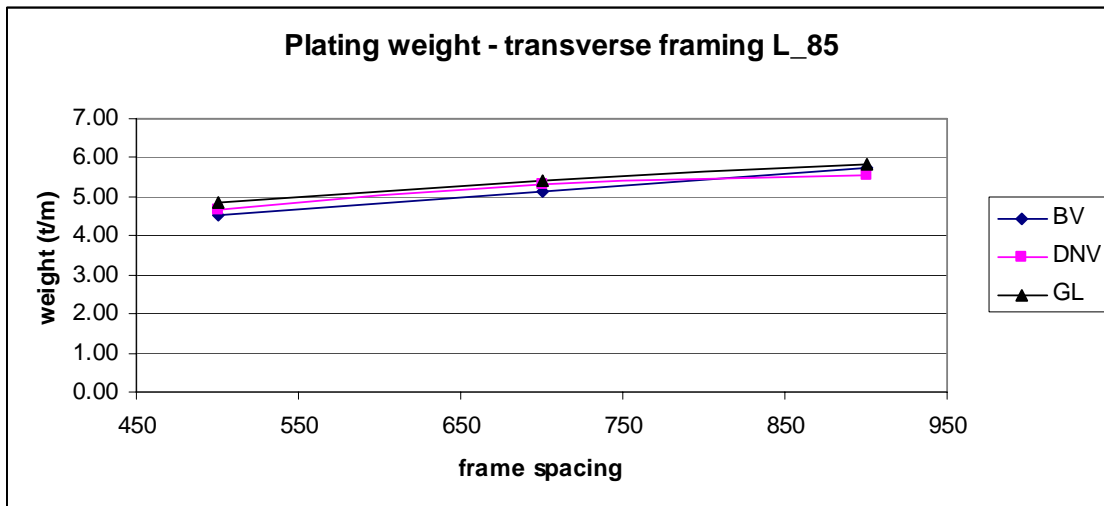


Figure 5.10: Cross-section Weight with Transverse Framing



The following conclusions can be based on these results:

- The differences between cross section weights from scantlings developed with different rule sets do not appear to be large in most cases, though the differences are up to 20% in some cases.
- Minimum requirements in BV rules generally lower than the other rule sets investigated
- To some extent the greatest net cross section weights result from rules with smaller mandated corrosion additions, such as GL and LR Naval Rules. Once the corrosion additions are added the differences tend to reduce.

### 5.2.2 General Cargo Carriers over 90m in Length

Scantlings were calculated for larger general cargo ships with following dimensions:

**Table 5.9: Larger General Cargo Ships**

<b>Ship Particulars</b>	<b>Ship No 1.</b>	<b>Ship No 2.</b>	<b>Ship No 3.</b>
Loa (m)	150.00	200.00	250.00
Lbp(m)	142.50	190.00	237.50
B (m)	19.00	30.80	31.67
D (m)	10.63	14.18	17.72
T (m)	8.80	10.30	14.66
Cb	0.75	0.75	0.75

All the ships considered are classed 1A1 General Cargo Carrier, and have a single side and double bottom, and longitudinal framing system. Cross-section weight is based on required net scantlings.

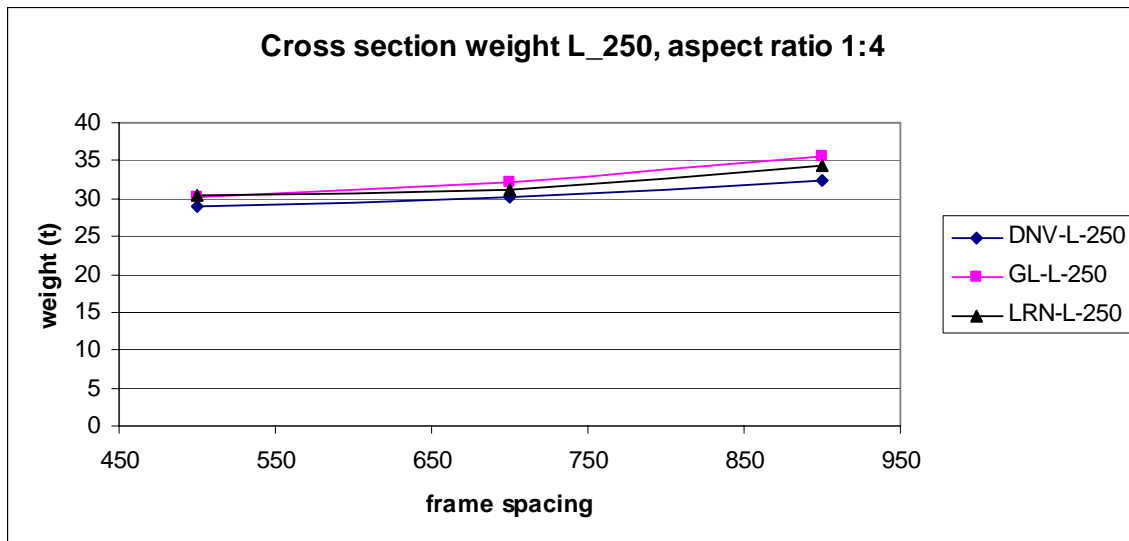
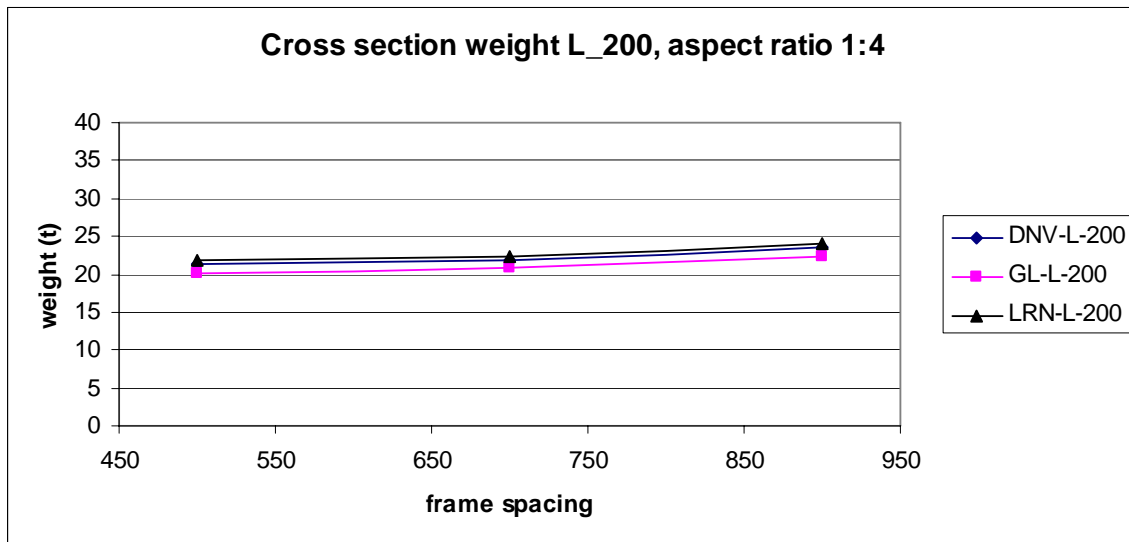
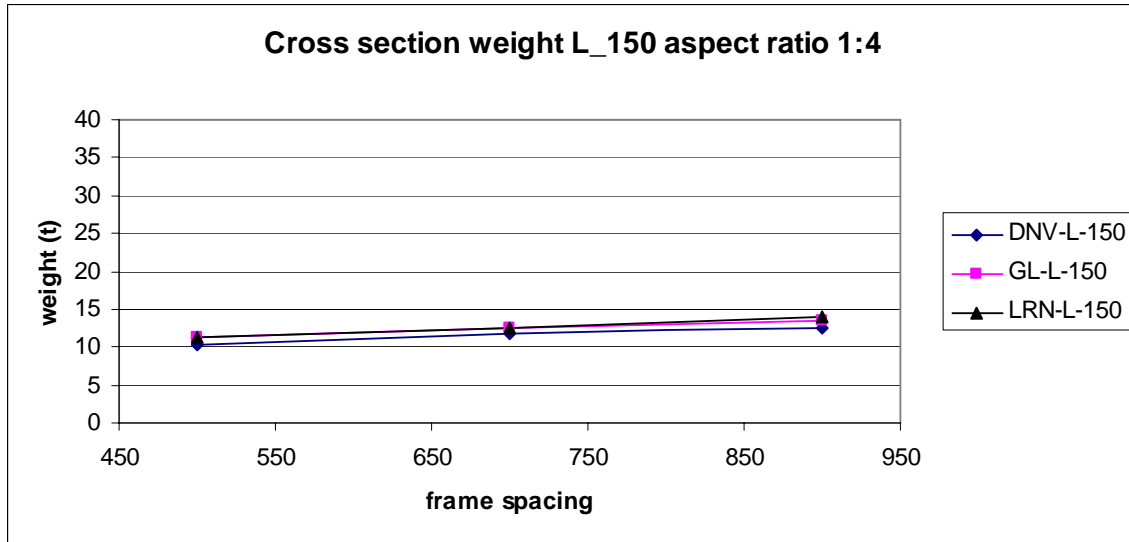
The rule sets used for comparison included DnV, GL and LR Naval Rules (S1 type of ships).

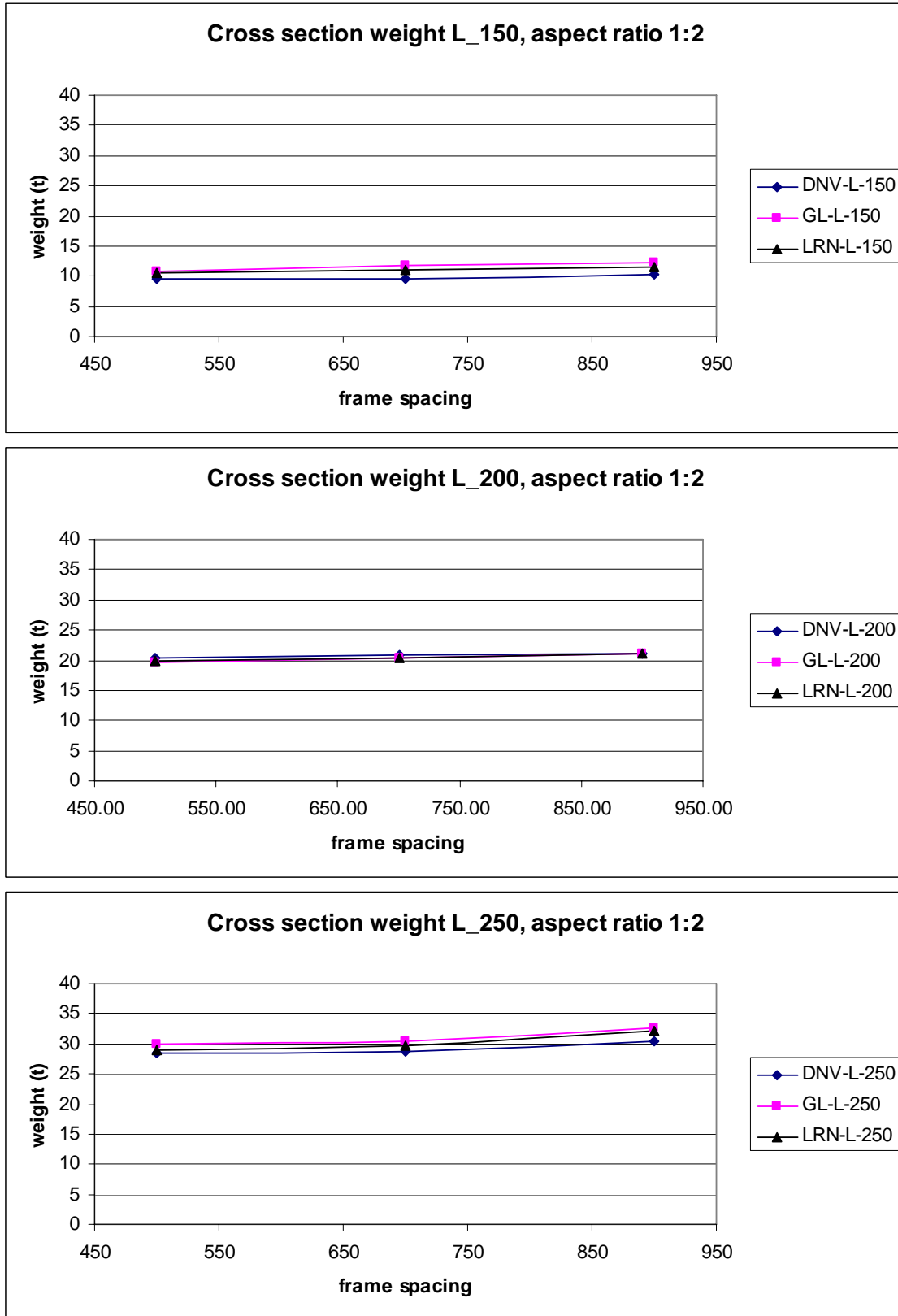
Cross-section scantling and consequently cross-section weight was determined using the following software packages:

- NAUTICUS – DnV
- POSEIDON – GL

LR Naval Rules scantlings were calculated using Microsoft Excel™ spreadsheets.

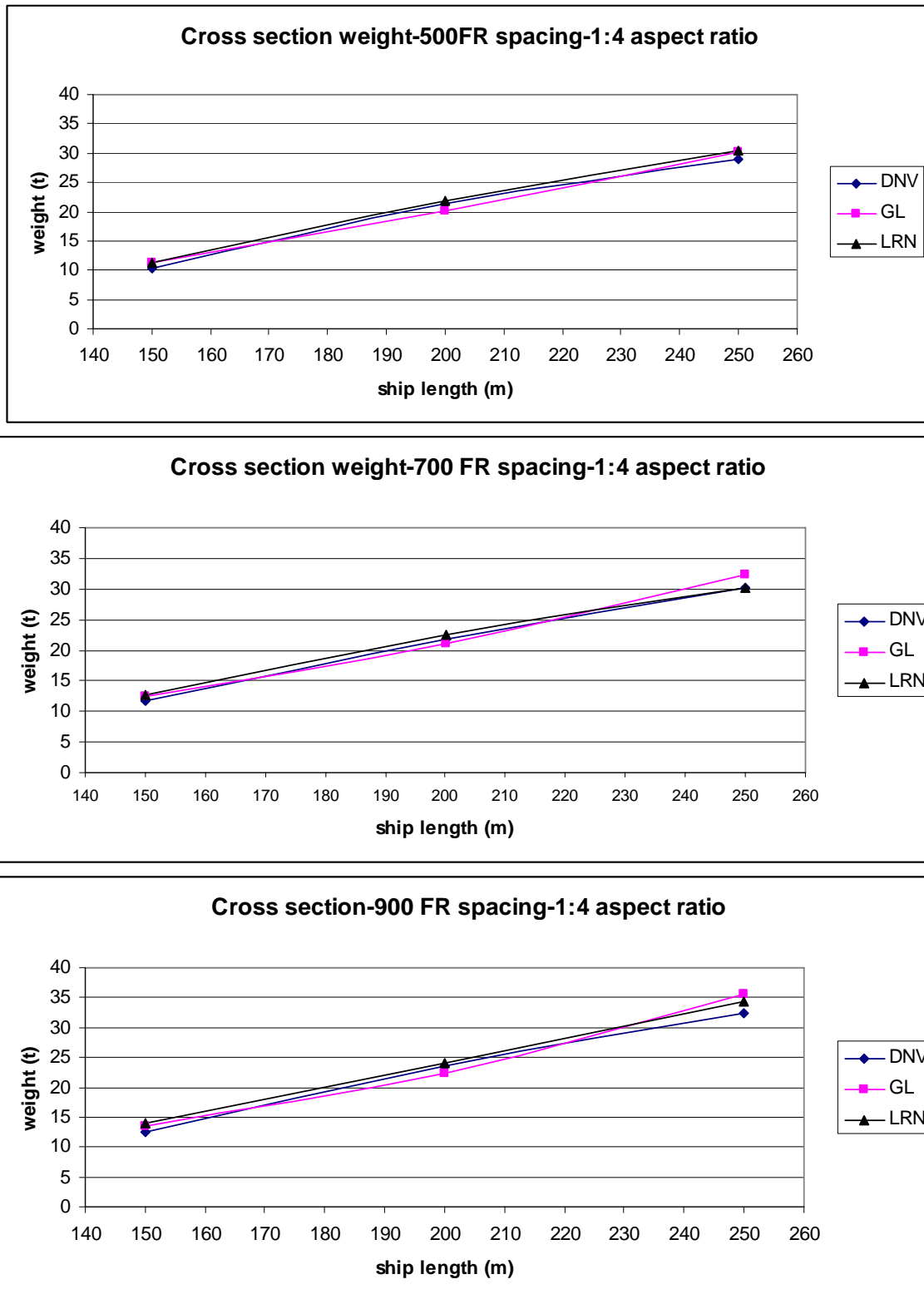
The resulting cross-section weights per meter length for the different rule sets, different frame spacing and aspect ratios are presented in following figures. As only 235 MPa steel was used, hull girder modulus requirements govern in many cases.





**Figure 5.11: Cross-section Weights for Larger General Cargo Carriers**

Changes in cross-section weight as a function of ship length are shown in Figure 5.12.



**Figure 5.12: Cross-section Weights Larger General Cargo Carriers as Function of Ship Length**

Based on the results obtained, the situation is very similar to that for the smaller ships – structural weights are very similar under all rule systems.

### 5.2.3 Bulk Carriers over 150m in Length

In this section, scantling was calculated and weight compared for the bulk carriers with following dimensions:

**Table 5.10: Bulk Carriers**

<b>Ship Particulars</b>	<b>Ship No 1.</b>	<b>Ship No 2.</b>	<b>Ship No 3.</b>
Loa (m)	265.00	210.00	170.00
Lbp(m)	256.29	203.09	164.41
B (m)	42.71	33.85	27.40
D (m)	22.00	17.43	14.11
T (m)	15.65	12.40	10.04
Cb	0.82	0.82	0.82

All the ships considered are classed 1A1 Bulk Carrier, without additional class notations, and have a double side and double bottom, and longitudinal framing. Cross-section weight is calculated using required net scantlings.

Rule sets used for comparison analysis were DnV, JBP and LR Naval Rules (S1 type of ships).

The cross-section scantlings and consequently cross section weight were determined using following software packages:

- NAUTICUS – DnV
- NAUTICUS – JBP

LR Naval Rules scantlings were calculated using Microsoft Excel™ spreadsheets.

The resulting cross-section weights for different rule sets as a function of ship length are given in the following figures.

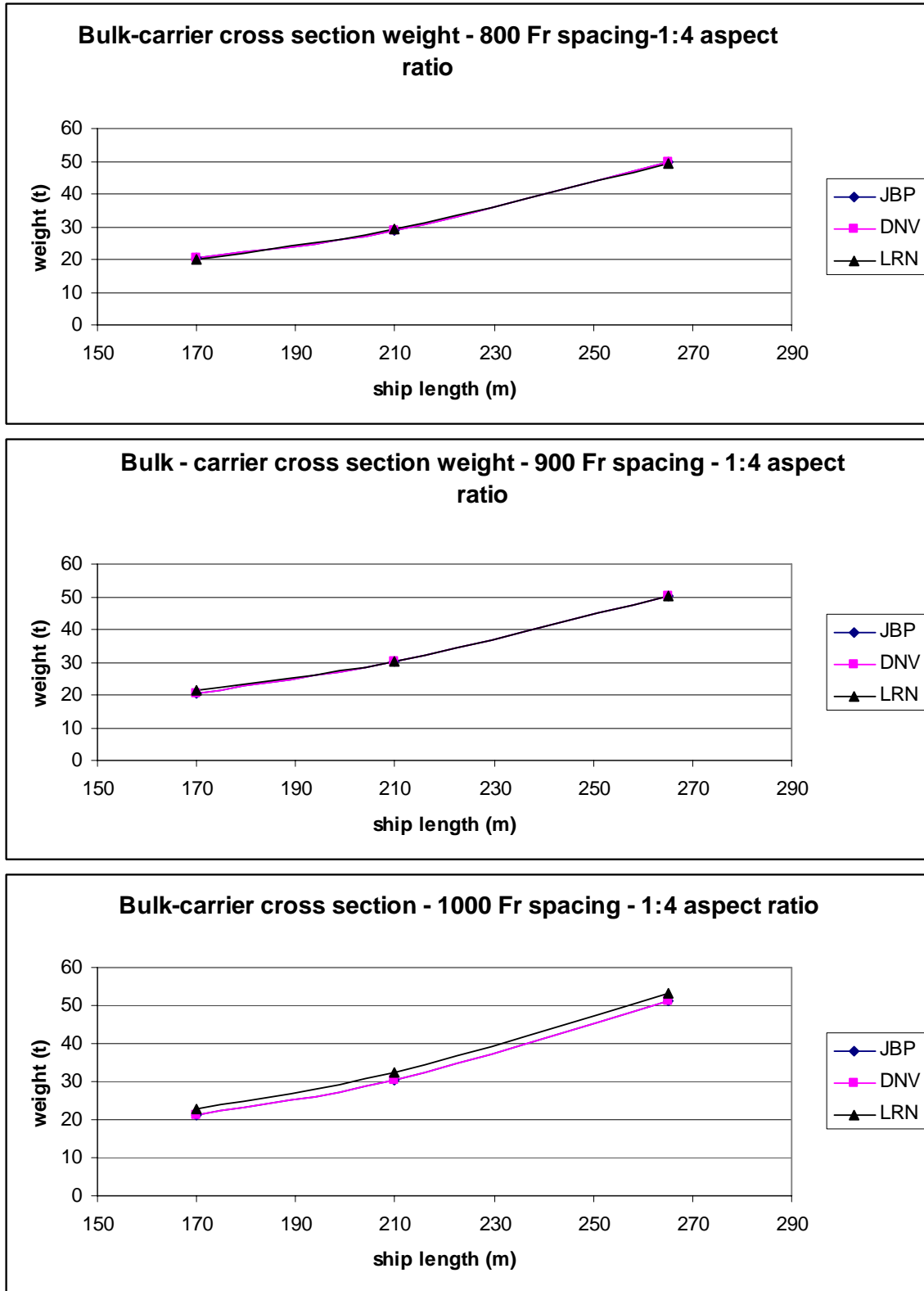


Figure 5.13: Cross-section Weight for Bulk Carriers as Function of Ship Length

Again, weight differences are minimal.

#### 5.2.4 Tankers over 150m in Length

Scantlings were calculated and weight compared for the tankers with following dimensions:

**Table 5.11: Tankers**

<b>Ship Particulars</b>	<b>Ship No 1.</b>	<b>Ship No 2.</b>	<b>Ship No 3.</b>
Loa (m)	265.00	210.00	170.00
Lbp(m)	256.29	203.09	164.41
B (m)	42.71	33.85	27.40
D (m)	22.00	17.43	14.11
T (m)	15.65	12.40	10.04
Cb	0.82	0.82	0.82

All the ships considered are classed 1A1 Tanker for Oil, without additional class notations, and have a double side, double bottom and three longitudinal bulkheads, with longitudinal framing. Cross-section weight was calculated using required net scantlings.

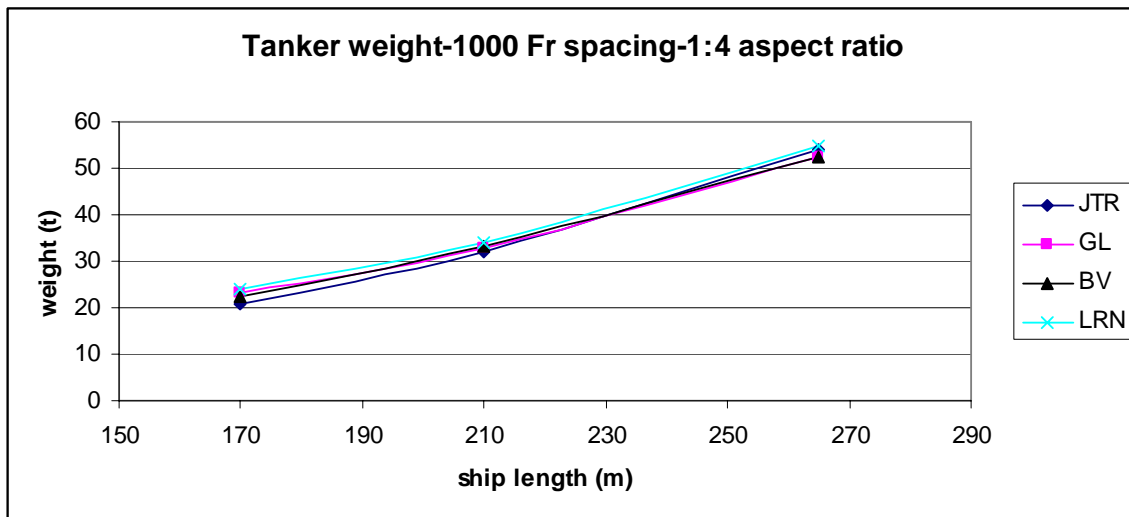
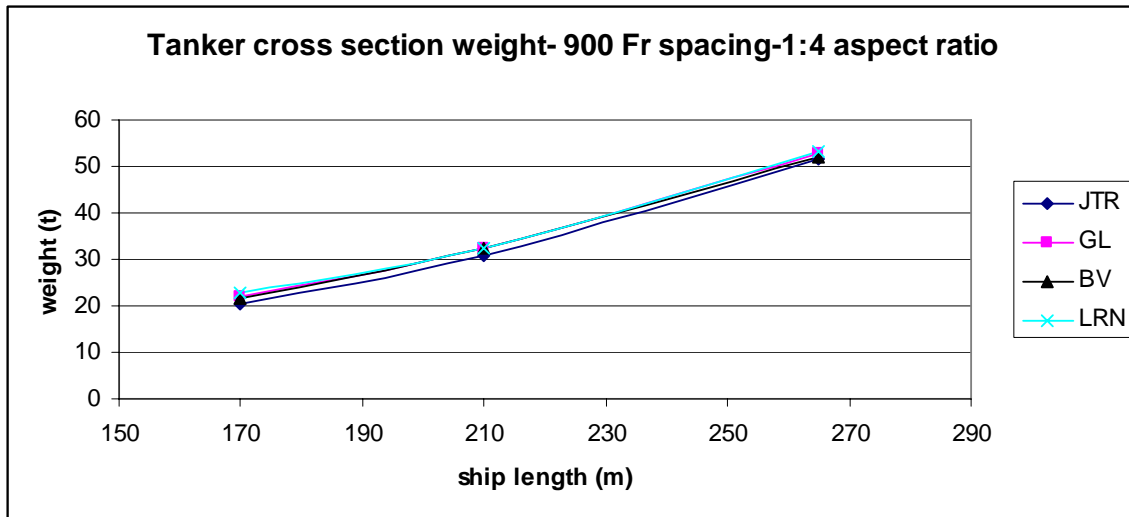
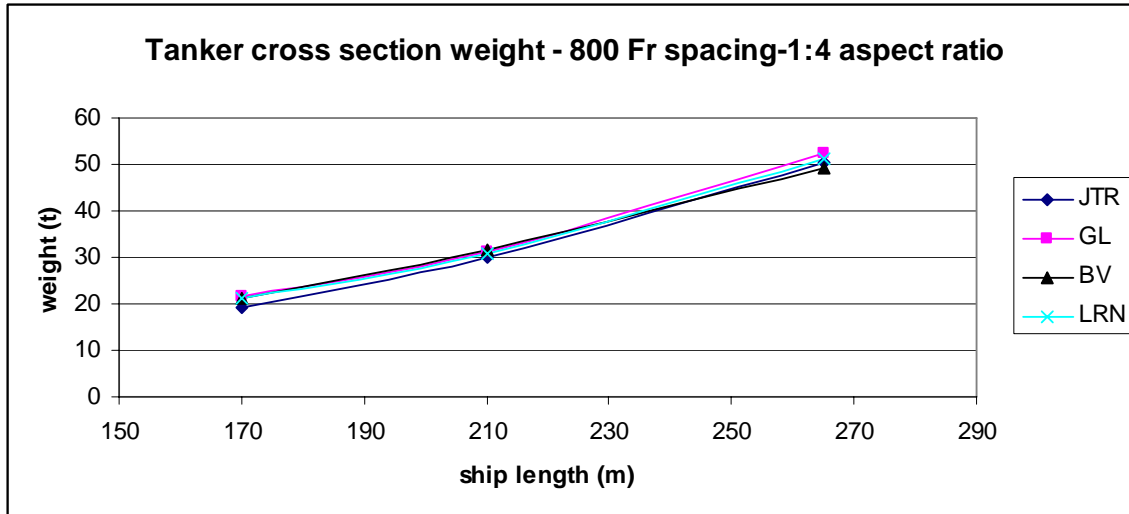
Rule sets used for comparison analysis included BV, GL, JTR and LR Naval Rules (S1 type of ships).

Cross-section scantlings and consequently cross-section weight were determined using the following software packages:

- NAUTICUS – JTR
- POSEIDON – GL
- MARS – BV

LR Naval Rules scantlings were calculated using Microsoft Excel™ spreadsheets.

The resulting cross-section weights per meter length for the different rule sets, different frame spacing and aspect ratios are presented in following figures. As only 235 MPa steel was used, hull girder modulus requirements govern in many cases.



**Figure 5.14: Cross-section Weights for Tankers as Function of Ship Length**



### 5.2.5 Summary

For all of the ship types and sizes examined, the outcomes are remarkably similar under any reasonably current rule system. This is perhaps not very surprising, given that there is a wealth of experience with conventional ships of these types and configurations. However, it does allow some issues to be highlighted:

- The new JBR and JTR, which claim to increase scantling requirements, do so (if at all) only through corrosion (and possibly fatigue) allowances; and
- The newer rules add considerable complexity, but this seems to have only a very minor effect on outcomes;

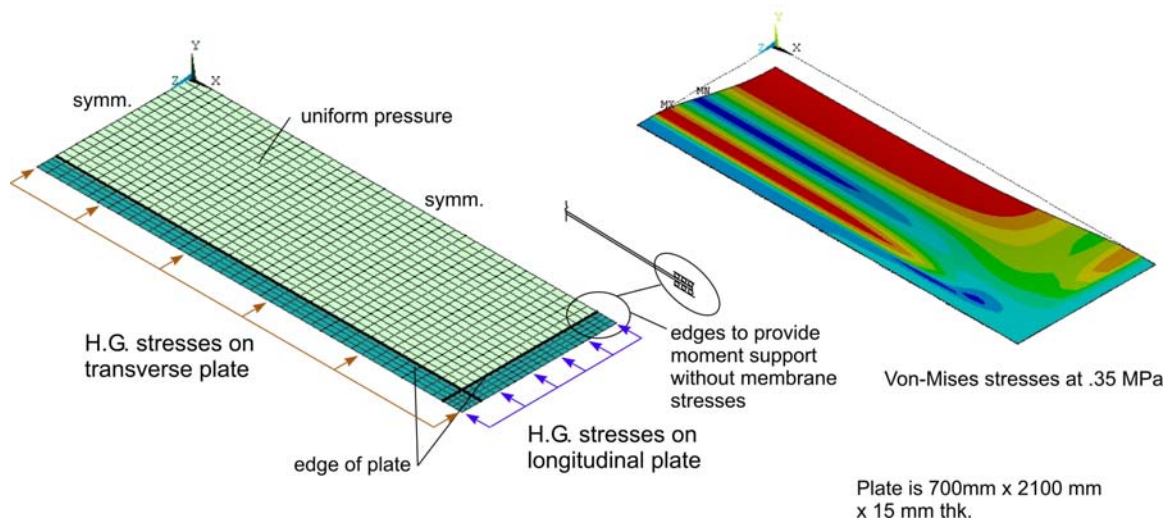
It should also be acknowledged that the scantlings developed were, in most cases, generated semi-automatically by Class software packages rather than by direct application of the analysis formulae of the rules themselves. It has been assumed that the answers supplied are accurate responses to the requirements.

## **5.3 Finite Element assessment**

The aim of this task is to use finite element analysis to explore the design issues discussed in Section 4. The data in Figure 4.6 in Section 4 shows that combined stresses will normally exceed the yield stress at the design condition. In this section the implications of this will be explored.

### 5.3.1 Plate Capacity

The first issue is the plate behaviour. Figure 5.15 shows the finite element model used. The plate is 700mm x 2100 mm x 15 mm thick. The steel has a yield strength of 235 MPa with a Young's Modulus of 200 GPa and a post-yield modulus of 1 GPa. This plate is in the range of typical ship plates. The finite element modeling was performed in ANSYS, using a shell element (Shell 181). One quarter of the plate was modeled with symmetry conditions on the two centerlines. The model could be used for both a longitudinal and a transverse plate, depending on which direction the in-plane hull girder stresses were applied.



**Figure 5.15: Plate Finite Element Model**

The biaxial stress conditions are tabulated in Table 5.12. The plate’s notional capacity is reduced due to the presence of hull girder stresses. The notional design capacity of the plate is then calculated using equation 4.3. Recall that this equation is just a rearranged version of the plate design equation found in many ship rules.

$$p = 4 \cdot \sigma \cdot \left(\frac{t}{s}\right)^2 \quad (4.3)$$

The plastic capacities of plates, using finite element models, have been assessed for three cases. All plates are 15mm thick, 700mm wide and 2100mm long. Case 1 is for a transversely framed ship with the bottom stress at 175 MPa (as would happen if the neutral axis was at the half-height). In case 1a, it is assumed that the bottom hull girder stress is 87.5 MPa. In case 2, longitudinal framing is assumed, with a hull girder stress of 175 MPa.

The finite element analysis (Figure 5.16) shows that plates have a significant post-yield reserve. At the design point, which is something close to the ideal ‘3-hinge collapse’ point, the actual deformations are quite small (<1mm). As the deformation increases, the capacity rises significantly. As shown in Table 5.12, the capacity for 1mm deflection (invisible except with special equipment) is 60% to 95% above the design capacity. At 5mm deflection (1/3 of plate thickness and just visible with the right lighting), the capacity is 260% to 450% of the design values.

From the above discussion, it is clear that there is a significant reserve (factor of safety) in the plating. One might define a 5mm deflection as the beginning of deflections of concern, though concern should be more for serviceability rather than safety. The acceptability of permanent deformation from serviceability considerations is itself a complex subject, which is not treated consistently between Classification societies (or navies). However, in most cases larger deflections than 5mm would be considered acceptable.

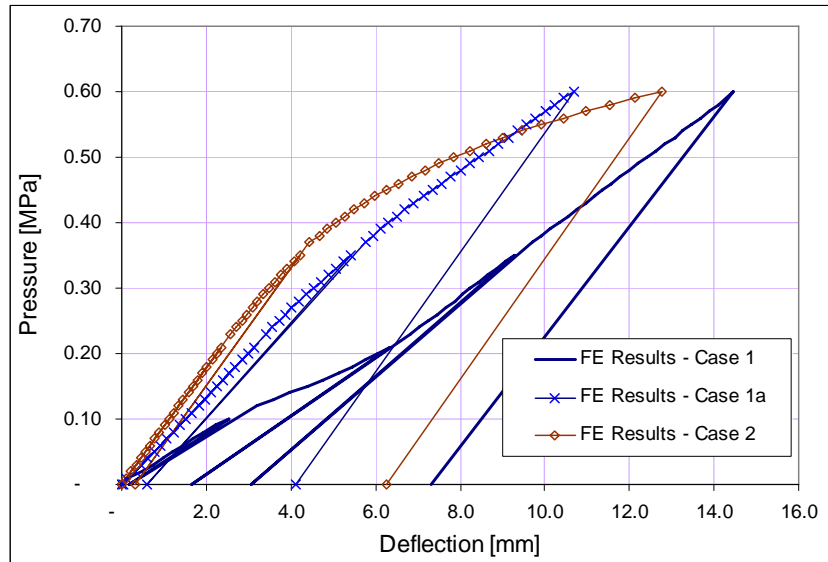


Figure 5.16: Plastic Capacity Comparison for DnV Bottom Plating

Table 5.12: Calculated Bottom Plate Capacity for DnV Commercial Rules (700x2100x15pl)

Case		1		1a		2	
Description		Transverse		Transverse		Longitudinal	
Assumptions		$Z_B = Z_R$ (note 1)		$Z_B = 2 Z_R$		$Z_B = Z_R$	
Hull girder stress [MPa]		175		87.5		175	
Design Plate stress [MPa]		55		115		120	
VM Total Stress [MPa]		230		212		235	
Pd Design Capacity (eq3.3) [MPa]		0.101		0.211		0.220	
Finite Elements Results		[MPa]	% Pd	[MPa]	% Pd	[MPa]	% Pd
	P@ 0.1 mm perm defl. [MPa]	.084	83%	.227	108%	.29	132%
	P@ 1 mm perm defl. [MPa]	.16	158%	.38	180%	.43	195%
	P@ 5 mm perm defl. [MPa]	.46	455%	.65	308%	.58	264%

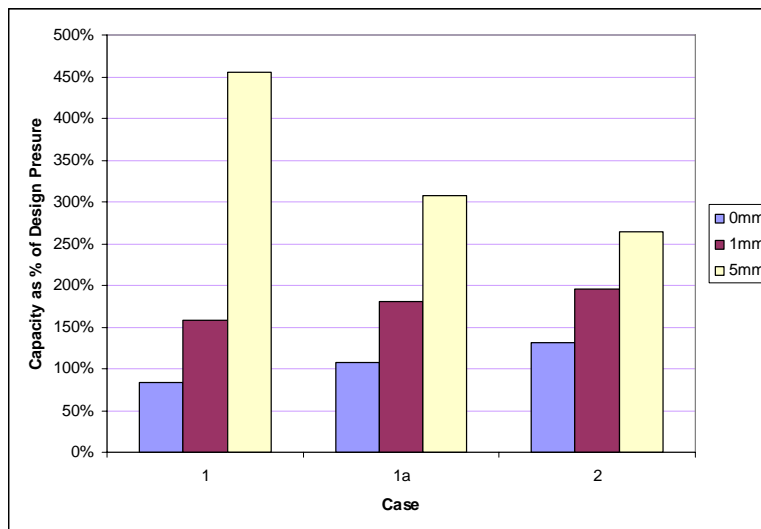


Figure 5.17: Plastic Capacity Comparison for DnV Bottom Plating

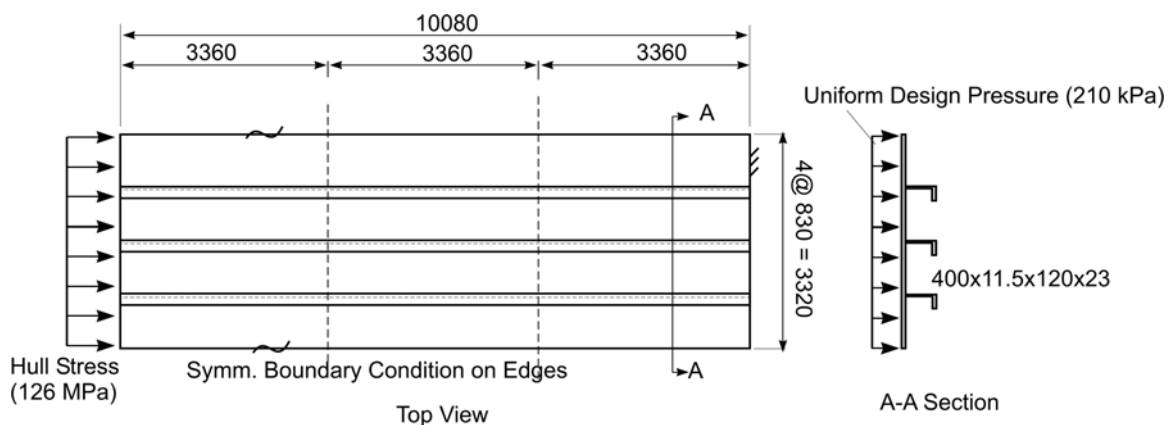
From an actual safety point of view, the plating can withstand far greater loads prior to rupture. For example, the maximum strain in Case 2 at 0.6 MPa is only 0.9% (strains of up to 30% are possible in ductile steel). For Case 2, the 0.6 MPa represents 2.64x the design load, a load level that would be extremely unlikely during normal operations. It must be understood that this plating analysis assumes that the hull girder and framing are intact.

### 5.3.2 Frame Capacity

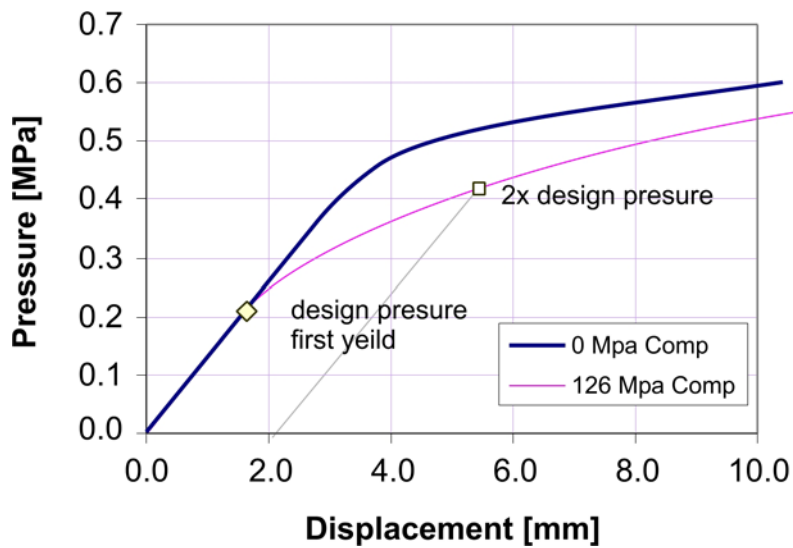
To examine the design of a simple bottom grillage, a 3-frame (3x4 bay) stiffened panel has been designed. The basic design comes from using Germanischer Lloyd’s program PoseidonND(ver5.5). A 50k tdw bulk carrier was chosen as the vessel. The vessel properties are:

- Length - Lbp: 218.5m
- Breadth - B: 32.24 m
- Height - H: 20m
- Draft - T: 14.5m
- Block - Cb: .75

With these properties, the design bottom panel is as shown in Figure 5.18. The hull hog bending stress at the design condition is 126 MPa. The design lateral pressure on the outer shell is 210 kPa. The finite element analysis examined the ability of the grillage to resist lateral load. Figure 5.19 shows the deflection at the center of the frame plotted for each load level. The two curves show the influence of the hull bending stress. Up to the design pressure, the hull stress has almost no influence on the response. For higher lateral pressures the presence of the hull stress increases the deflection of the grillage. Nevertheless, the grillage can withstand twice the design pressure with only 2mm of permanent deflection (5.5mm of total deflection). This level of deflection is very minor.



**Figure 5.18: Grillage for Finite Element Analysis**



**Figure 5.19: Load vs. Lateral Deflection of the Grillage**

Figure 5.20 shows the development of plastic strain as the load increases from the design pressure to 2x the design pressure to almost 3x the design pressure. At the design pressure, there is only a very small area where there is some plastic strain. At this point, the system is essentially elastic. Even at nearly 3x the design pressure, much of the structure is still elastic. Figure 5.21 shows the von-Mises equivalent stress, along with exaggerated (50x) deflections. Figure 5.22 shows the von-Mises stresses at 2x the design pressure, with both true and exaggerated deflections. The true deflections are too small to be seen.

### 5.3.3 Discussion

These results show that both the plating and framing can have significant post-yield capacity without significant deflections. This reserve provides a significant factor of safety and serviceability; in comparison with the lack of nominal safety factors noted at Section 4. However, this approach raises a number of questions with respect to the underlying approach. The Rules are based on a linear-elastic idealization of structural response, but rely on other mechanisms to provide even the nominal level of safety and serviceability. It is highly probable that there will be very variable reserves for different configurations and materials; but this is ignored in the current approaches. In essence, the current formulae are being applied outside their range of validity, but this is not apparent to any normal designer or regulator. Some implications and potential remedial measures are discussed at Section 6.



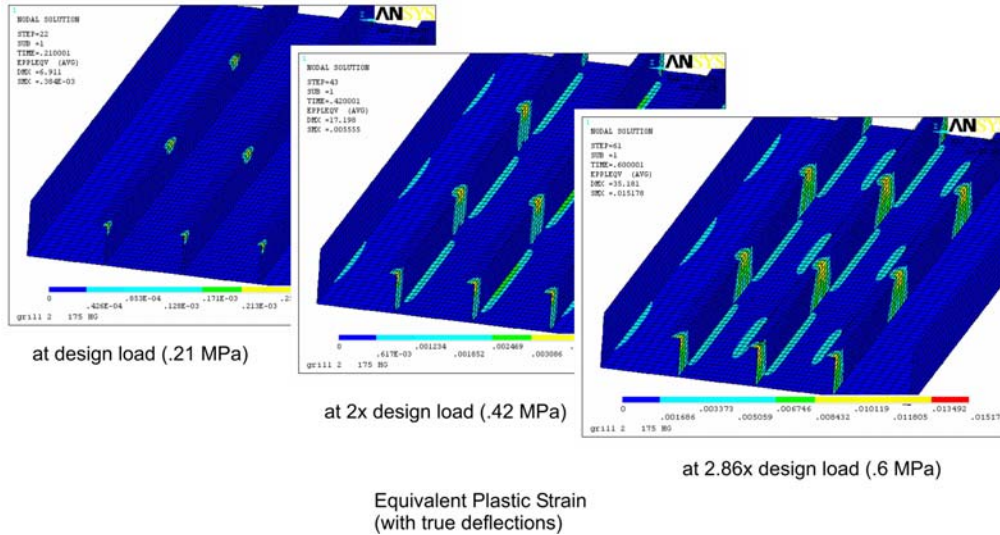


Figure 5.20: Plastic Strain at 3 Load Levels for the Bottom Grillage

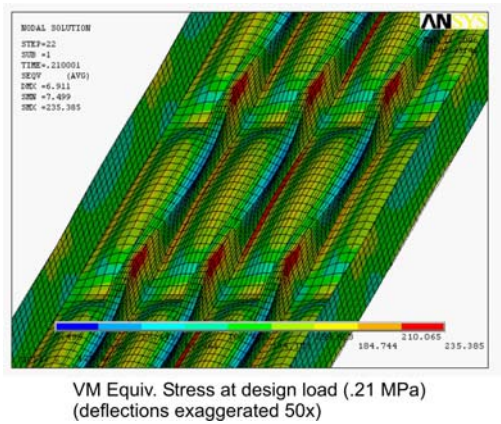


Figure 5.21: Plastic Capacity Comparison for DnV Bottom Plating

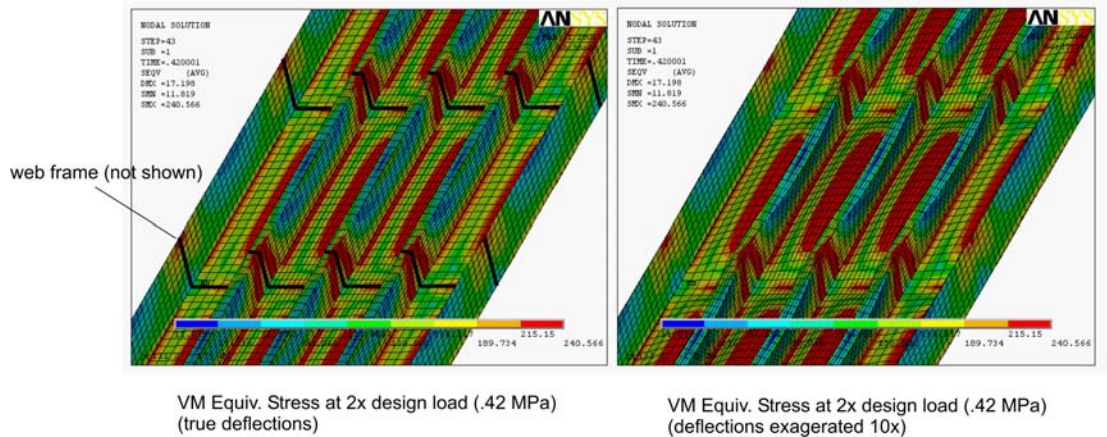


Figure 5.22: Plastic Capacity Comparison for DnV Bottom Plating

## 6. FUTURE DEVELOPMENT OF UNIFIED STANDARDS

This project is aimed at the development of new unified ship structural design standards. In the project proposal and with the subsequent agreement of the project technical committee (PTC), this extremely ambitious objective was refined to focus on the development of principles and features that any future standard should aim to follow and to contain. In this section of the report, the analyses of current standards described above are used to illustrate how the relevant principles and features can be identified. They are also used to discuss how current standards fall short of the ideal.

### 6.1 Underlying Principles

All design standards have the same goal, which is to ensure acceptable performance of the system under consideration. To accomplish this, all design standards must anticipate the relevant design challenges and set criteria that will ensure that all designs will exhibit acceptable in-service behaviors. In most situations involving ship structures, the design process has become one of satisfying the structural standard. The process of structural design is now largely eclipsed by efforts to comply with standards. In order to improve vessel designs in future, it must be acknowledged that it is crucial to have the best possible structural design standards, because the vessels can only be as good as the available standards. If the intent is to encourage innovative and effective new structural designs, there is a need to have standards that will not only permit, but actively encourage innovation. Innovation is normally the last thing that occurs when comprehensive standards are established; and there is a real need to overcome this tendency. The text below outlines some principles for developing standards that will be both rigorous (reflecting experience and demanding provable performance) and flexible (open to innovation).

#### 6.1.1 Transparency in Standards

Standards will always be developed by a relatively small subset of domain experts, for application by a broader user community with varying levels of technical expertise. No standard will ever be perfect, as any standard can only be an incomplete representation of physical reality. Similarly, standards will always be susceptible to improvement or extension as our understanding of structural mechanics, materials, etc improves. Further, current standards (and any others that may be developed in the short or medium term) will always have more or less limited ranges of validity; for example due to the differences in loading regime applicable to specialized ship types.

For all of these reasons, it should be required by the user community and other stakeholders that standards are transparent, in the sense that underlying assumptions are made explicit, the sources of formulae and analytical approaches are cited, methods and data used in validating or calibrating outputs are identified, and any remaining issues and uncertainties affecting the application of the standard are highlighted.

In reality, this principle is rarely reflected in how new or revised standards are promulgated. No standard explicitly includes much of this type of background material, standards themselves almost never refer to background materials, and much supporting documentation may never become publicly accessible. This is the case even where extensive background materials do exist, and have been developed to support standard development; as for example with the IACS Unified Requirements for Polar Ships and the ISO Offshore Standards.

As a consequence of this lack of transparency, it becomes difficult for any individual or organization to critique a standard, or propose improvements to it, except by reference to unsatisfactory outcomes. This can apply even within the organization responsible for the original development of the standard, once some years have passed and the individuals responsible for the initial development have left.

### 6.1.2 Modularity

Problems arising from a lack of transparency can be aggravated by failure to observe another important principle in standards development, that of modularity. In a modular approach, each major element of the approach to an eventual solution is handled separately, rather than combining (parts of) several elements within a single section or algorithm.

As noted earlier, the essential content of any structural standard can be broken into four main areas, each of which can be further subdivided. Modularity should apply at the very least across the main areas of idealization, load, response, and safety factor; and preferably to the more detailed subdivisions. Our understanding of how to represent or model each area tends to advance with time. Therefore, if standards are constructed within a modular framework, it is easier to identify both when an update to a standard is warranted, and also how it can be implemented.

Most current standards, as discussed in earlier sections, do not provide for this type of approach. Idealizations and factors of safety may be buried within loading or response formulations in some areas of a standard, and covered explicitly in others.

For standards to be truly modular, each component must stand on its own. This means that the load portion must be self-contained and valid, regardless of the response or factor of safety formulation. Present codes do not achieve this. The main reason is that virtually all ship structural standards are ‘calibrated’ by past practice to give a final result that agrees with past practice. If new theories about load mechanics argue for a change in design load, the calibration will accommodate the load change by adjusting some other component so that the final requirement remains unchanged. This can be seen in the discussion of the BV partial safety factors at Section 4.3. Unfortunately, this type of adjustment is almost inevitable, because any new theory of load does not change the loads that the sea applied to older vessels. The empirical evidence from thousands of successful vessels strongly supports the status quo.



This can only be overcome when we develop a very high level of confidence in our load and strength descriptions, and have a comprehensive explanation of why various past practices have or have not worked. For example, this report has shown that structural behavior is likely to have involved low levels of plastic response on a very regular basis, and thus provides a new insight into how the load and response models can be reconciled with past experience. Many more issues, involving corrosion, fatigue, etc., need to be examined to fully reconcile the design requirements with actual experience. Only in this way will we get to the point where we can confidently trust all the various aspects of the design process independently.

### 6.1.3 Complexity

Results presented at Section 4 show how standards with considerable variability in their level of complexity produce very similar outcomes in terms of scantling requirements.

There are no inherent advantages to complexity – it requires additional effort to generate outcomes, and there may be an increased potential for misunderstanding and in the worst case for actual and undetected error. An increase in complexity can only be justified if it produces a substantially improved level of accuracy or a significantly better representation of the range of validity of an approach.

In order to quantify what a “substantial” or “significant” improvement is, it can be useful to examine the range of uncertainty, or confidence limits, associated with other aspects of the standard. For example, there is little point in representing a buckling collapse load with 2% greater accuracy if permissible misalignment can lead to a 20% difference in outcomes. Again, taking a modular approach to the presentation of requirements can highlight cases in which one area of a standard is out of step with the overall approach.

### 6.1.4 Consistency

Within any module of a standard, and across the approach as a whole, the approach that is being taken should be consistent and logical. This does not always appear to be the case with current standards. As discussed at Section 5.3, the actual factors of safety in current bottom structure design appear to rely on a plastic response mechanism that is not acknowledged (let alone analyzed or quantified) in any aspect of the standards. This is both an obstacle to understanding and modifying a standard; and also a potential hazard, as the range of validity of the nominal and actual response mechanisms may differ.

Where a standard is not based on the underlying physics of the actual situation, this may aggravate a tendency to introduce complexity. Pre-Copernican astronomy was forced into increasing complexity to explain planetary motions in an earth-centred universe. Accepting the helio-centric model provided both a more accurate and a much simpler set of descriptions.

## 6.2 Necessary Features

As discussed earlier, any structural design standard should include a number of key features:

- i) an idealization approach;
- ii) a definition of the loading regime;
- iii) a response definition; and
- iv) a factor of safety.

The standards reviewed in Sections 2 and 4 have been “decomposed” in order to identify these components, which in current standards are often buried within formulae and implicit assumptions. This highlighted the need for the principles of transparency and modularity that have been discussed above. Assuming that progress can be made in these areas, and in order to provide more specific guidance for future standard development, some necessary features for each main feature are highlighted below.

### 6.2.1 Idealization Approach

Most modern standards provide a reasonable representation of many boundary conditions and other aspects of idealization. Aspects that tend to be neglected include:

- fabrication tolerances
- in-service effects

These aspects tend to add considerable complexity to the design/analysis problem. A way should be found to take these effects into account without greatly increasing the design cost. One way may be to use an approach that has proven useful in fatigue analysis. That is to classify connection and other details in terms of their susceptibility to fabrication tolerances and in-service (aging) effects. Components subject to these effects could have a detail-specific factor of safety applied. The cost and benefits of such an approach would have to be carefully examined.

### 6.2.2 Load Definition

Virtually all ship structural standards employ highly idealized load descriptions. These are often formulated starting from very simple mechanics (e.g., hydrostatic pressure on the bottom), with the inclusion of a ‘factor’ to account for dynamic effects or other complexities.

Traditionally, it has been unrealistically expensive to monitor or collect long-term data on sea loads, or to model these numerically. Advances in technology, and service demands are now changing this situation quite rapidly and in the short-to-medium term future it is likely to become possible to project through-life loading regimes (and probabilities of exceedence) with much greater accuracy and confidence. Improvements in this area are overdue and should be factored into future standards development.

### 6.2.3 Response Definition

This is an area where there has been considerable progress in understanding, as outlined at Section 3. In consequence, there is potential for much innovation. There is a growing capability to calculate complex structural responses (linear, non-linear, dynamic, long-term) which provides the ability to examine not only the behavior of existing vessels, but also to consider new construction materials and geometries. New structural standards need to find ways to make use of this growing capability, and yet still guard against the potential dangers of unproven approaches.

### 6.2.4 Factors of Safety

All aspects of design are subject to uncertainty. One way of dealing with this uncertainty is to employ some concepts derived from probability theory. When the statistical distributions of the key design input parameters are known (or can be estimated) the statistical distribution of the required output can be estimated. This concept is used to increase the requirements to account for the uncertain variability in the estimated capability. In the 1980s and 1990s the SSC funded a significant amount of work in this general area, examining the potential use of First- and Second-Order Reliability Methods (FORM and SORM) based on probabilistic representations of load and response. To date, there has been little or no adoption of this type of approach in the ship structural field.

There has been a trend towards the inclusion of a partial safety factor methodology in some new ship structural standards, notionally taking a more deterministic approach to uncertainties in load and response. As noted above, in the cases examined these have been implemented in a way that may accomplish little more than misdirection, creating a false impression of safety levels and potentially undermining the safety of vessels.

The above may seem to be somewhat provocative statement. However, let us examine a number of points raised earlier. In section 3, a reasonably wide review of available data and literature on ship structural behaviour was presented. In section 4, a review of the several extant standards was undertaken. In section 4, the aim was to dissect the rules to their essentials, show the rationales contained therein and illuminate where the rules contained their factors of safety. Two very illuminating findings arose from this review. One is that all the rules have been formulated on similar and relatively simple assumptions. Nowhere were found complex rule components reflecting the in-depth and sophisticated research of the type referenced in section 3. This is not necessarily a bad thing, but it does suggest that there is far more known about complex ship structural behaviour than is captured in any design standard. The second finding was even more surprising, though is now very clear. No obvious factors of safety were found where one might expect. The loads and elastic capacity appear to be quite precisely formulated with little or even no reserve. Instead, a significant factor of safety was uncovered (in Section 5.3) in the post-yield behaviour.

Rather than apply factors of safety to the rule formulations as they presently exist, a far better strategy would be to re-write the rules to reflect the real behaviour of ships. For example, Naar (2006) executed an extensive behavioural analysis of multi-deck vessels, knowing that present rule formulations are inadequate in reflecting their true capabilities and reserves. This required a very sizeable analysis effort, though also lead to the development of a better simple analysis tool for this type of vessel. This approach may have much to say about future ship structural standards. The importance of increasingly sophisticated analysis of increasingly complex vessels must be addressed. Design by simulation is an approach to design that may change the way design is conducted in the medium term.

## 7. CONCLUSIONS

This project has explored a wide range of issues of importance to current and future ship structural design standards; and how these are currently being addressed. It has concluded that, while current standards generally ‘work’, they have significant deficiencies. One of the most significant of these is that their format, contents, and overall approach act to inhibit future standard development as our understanding of any and all aspects of structural design improves.

The project has identified a number of key principles and features that should be adopted in future standards development.

The features of an ideal structural standard should:

1. be based on accurate models of in-service loading and response;
2. address all response and failure mechanisms;
3. address uncertainties in all aspects of the models; and
4. incorporate safety factors that reflect the consequences of failure.

In addition, it is desirable for it to:

5. be as simple as is reasonable, consistent with 1-4 above;
6. be adequately documented, to provide transparency that allows for understanding and for future upgrade;
7. be structured in a modular manner that facilitates ongoing improvement;
8. use concepts and terminology familiar to the intended user, or else provide guidance in any new methodologies; and
9. deal only with issues within its intended scope.

One of the more surprising aspects of most current standards is the very limited extent to which they incorporate any recent progress in understanding of either loadings or response. This may be a natural outcome of the current rule development process, but there is no reason why it should be an inevitable one. The users of rule systems should be prepared to push for more openness in rule development, and more meaningful participation by experts from outside the somewhat closed “Rule Community”.

## 8. REFERENCES

- (1) ABS Rules for Building and Classing of Steel Vessels, 2006
- (2) Akhras, G., Gibson, S., Yang, S., and Morchat, R., Ultimate Strength of a Box Girder Simulating the Hull of a Ship. Canadian Journal of Civil Engineering v. 25 no. 5 (October 1998) p. 829-43
- (3) Alagusundaramoorthy P. Aruljayachandran S. and Sundaravadivelu R. (2003) Stability of Stiffened Plates with Initial Imperfections, Journal of Engineering Mechanics, ASCE, July 2003
- (4) BV Rules for the Classification of Steel Ships, 2005
- (5) DesRochers C., Crocker J., Kumar R., Dick B., Lantos S.,(1993) Post – Yield Strength of Icebreaking Ship Structural Members, Transport Canada Technical Report, Contract No T8200-0-0561/01-XSD, Martec Limited, Halifax Canada.
- (6) DnV Rules for Ships, 1998
- (7) Egorov G, Kozlyakov V. (2004) Ship Grillages Ultimate Strength Assessment, Proceedings 9th Symposium on Practical Design of Ships and Other Floating Structures Luebeck-Travemuende, Germany 2004
- (8) Gielen, A.W.J., Vredeveldt, A.W., Janssen, G.T.M., (2004) Response of Stiffened Plate Panels to Hydrodynamic Impact. Theory and Experiments. 9th Symposium on Practical Design of Ships and Other Floating Structures Luebeck-Travemuende, Germany
- (9) GL Rules and Guidelines, 2006
- (10) Holtsmark G., Stromme H.O. (2004) The Capacity of Panel Stiffeners Subjected to Lateral Pressure Loads, DnV Technical Report, Report No. 2004-10068, Hovik Norway
- (11) Hu, S.Z., Chen, Q., Pegg, N., Zimmerman, T.J.E., Ultimate Collapse Tests of Stiffened-Plate Ship Structural Units Marine Structures, v 10, n 8-10, 1997, p 587-610
- (12) Hu, S.Z., Jiang, L., Finite Element Simulation of the Test Procedure of Stiffened Panels, Marine Structures, v 11, n 3, 1998, p 75-99
- (13) Joint Bulker Project - IACS Common Structural Rules for Bulk Carriers, (BV, Class NK, CRS, GL, RRS, KR), 2005
- (14) Joint Tanker Rules - IACS Common Structural Rules for Tankers, (ABS, DnV, LR), 2005
- (15) LR Rules and Regulations for the Classification of Naval Ships, 2003
- (16) Naar, H., (2006) “Ultimate Strength of Hull Girder for Passenger Ships”, Thesis for the Degree of Doctor of Technology – Helsinki University of Technology.
- (17) Østvold T. K., Steen E., Holtsmark G. (2004) Non-linear Strength Analyses of a Bulk Carrier – A Case Study, Proceedings 9th Symposium on Practical Design of Ships and Other Floating Structures Luebeck-Travemuende, Germany

- (18) Paik J.K. and Kim D.H. (1997), A Benchmark Study of the Ultimate Compressive Strength Formulations for Stiffened Panels, Journal of Research Institute of Industrial Technology, Vol 53 pp. 373-405 , Dec 1997, Pusan National University, Korea.
- (19) Paik, J.K., Thayamballi, A.K., Lee, W.H. (1998), A numerical Investigation of Tripping, Marine Structures, v11, p 159-183.
- (20) Rigo, P. , Sarghiuta, R.; Estefen, S.; Lehmann, E.; Otelea, S.C.; Pasqualino, I.; Simonsen, B.C.; Wan, Z.; Yao, T., Sensitivity Analysis on Ultimate Strength of Aluminium Stiffened Panels, Marine Structures, v 16, n 6, August, 2003, p 437-468
- (21) Rutherford S.E., (1984) Stiffened Compression Panels – The Analytical Approach, Lloyd’s Register of Shipping Technical Report, Report No. 82/26/R2, London UK
- (22) Schlüter H.-J, Shala D., Meinken A, Investigations into the Collapse Behaviour of Inland Vessels, EIWN 2001.
- (23) Servis D., Samuelides M., Louka T., and Voudouris G. (2002) Implementation of Finite-Element Codes for the Simulation of Ship-Ship Collisions, Journal of Ship Research, Vol. 46, No. 4, Dec. 2002, pp. 239–247
- (24) Technical Background on Corrosion Addition, JBP-IACS Common Structural Rules for Bulk Carriers
- (25) Torag, R. (DnV), Dr. Chon (KR), Åge Bøe (DnV), Update on the IACS Common Structural Rules for Tankers & Bulk Carriers, Beijing, October 31, 2005.

## 9. BIBLIOGRAPHY

- (1) Adamchak, J. C., 1979. Design Equations for Tripping of Stiffeners under Inplane and Lateral Loads, DTNSRDC Report 79/064, Carderock, Maryland.DC 20362.
- (2) API (2000). Bulletin on Design of Flat Plate Structures, API Bulletin 2V, 2nd edition.
- (3) Assakkaf, I.A. (1998) .Reliability-based Design of Panels and fatigue Details of Ship Structures. Dissertation submitted to the Faculty of the Graduate School of the University of Maryland, College Park in partial fulfillment of the requirements for the degree of Doctor of Philosophy.
- (4) Atua, K. I., 1998. "Reliability-Based Structural Design of Ship Hull Girders and Stiffened Panels," A dissertation submitted to the Faculty of the Graduate School of the University of Maryland, College Park in partial fulfillment of the requirements for the degree of Doctor of Philosophy.
- (5) Ayyub, B.M. and Atua, K., 1996. .Development of LRFD Rules for Naval Surface Ship Structures: Reliability-based Load and Resistance Factor Design Rules, Part I. Hull Girder Bending, Naval Surface Warfare Center, Carderock Division.
- (6) Ayyub, B.M., Assakkaf, I., Atua, K., Engle, A., Hess, P., Karaszewski, Z., Kihl, D., Melton, W., Sielski, R.A., Sieve, M., Waldman, J., and White, G. J. 1998. .Reliability-based Design of Ship Structures: Current Practice and Emerging Technologies, Research Report to the US Coast Guard, SNAME, T&R Report R-53.
- (7) Bleich, F. (1952). Buckling strength of metal structures, McGraw-Hill, New York.
- (8) Caldwell, 1965. .Ultimate Collapse Condition of the hull. Herzog, A. M., 1987. .Simplified Design of Unstiffened and Stiffened Plates, Journal of Structural Engineering, 113 (10), 2111-2124.
- (9) Canadian Standards Association. (1994) Limit states design of steel structures, CAN/CSA S16.1-94, Rexdale, Ontario.
- (10) Carlsen, C.A. (1977). Simplified collapse analysis of stiffened plates, Norwegian Maritime Research, No.4, pp.20-36.
- (11) Carlsen, C.A. (1981). A parametric study of collapse of stiffened plates in compression, The Structural Engineer, Vol.58B, No.2, pp.33-40.
- (12) Chatterjee, S. and Dowling, P.J. (1975). Proposed design rules for longitudinal stiffeners in compression flanges of box girders, Engineering Structure Laboratories, Civil Engineering Department, Imperial Collage, CESLIC Report BG 40, London, May.
- (13) Chen, W.F. and Atsuta, T. (1976, 1977). Theory of beam-columns, Vol.1 and 2, McGraw-Hill, New York.
- (14) Chen, W.F. and Liu, E.M. (1987). Structural stability, theory and implementation, Elsevier, New York.
- (15) Das, P.K. and Garside, J.F. (1991). Structural redundancy for continuous and discrete systems, Ship Structure Committee, SSC-354.



- (16) DnV (1995). Buckling Strength Analysis, Classification Notes No. 30.1, Det norskeVeritas, Oslo, July.
- (17) Ellinas, C.P., Supple and Walker, A.C. (1984). Buckling of Offshore Structures, a State-of-the-Art Review, Gulf Publishing Co., Houston.
- (18) Faulkner, D. (1975). A Review of Effective Plating for Use in the Analysis of Stiffened Plating in Bending and Compression, J. of Ship Research, Vol.19, No.1, pp.1-17.
- (19) Fujikubo, M. and Yao, T. (1999). Elastic Local Buckling Strength of Stiffened Plate Considering Plate/Stiffener Interaction and Welding Residual Stress, Marine Structures, Vol.12, pp.543-64.
- (20) Hughes, O. F., 1988. .Ship Structural Design, A rationally- Based, Computer-Aided Optimization Approach,. The Society of Naval Architects and Marine Engineers, Jersey City, New Jersey.
- (21) Hughes, O.F., Ghosh, B. (2003). Improved Prediction of Simultaneous Local and Overall Buckling of Stiffened Panels (in preparation)
- (22) Hughes, O.F., Nikolaidis, E., Ayyub, B., White, G. and Hess, P. (1994). Uncertainty in Strength Models for Marine Structures, Ship Structure Committee, SSC-375.
- (23) ISSC (2000). Ultimate strength, Proc. of the 14th International Ship and Offshore Structures Congress, Technical Committee III.1, Vol.1:253-321.
- (24) Johansson, B., Maquio, R., Sedlacek, G. (2001). New Design Rules for Plated Structures in Eurocode 3, J. of Constructional Steel Research, Vol.57, pp.279-311.
- (25) Kaplan, P., Benatar, M., Bentson, J., Achtarides, T. A., 1984. .Analysis and Assessment of Major Uncertainties Associated with Ship Hull Ultimate Failure,. Ship Structure Committee, Report SSC-322, U.S. Coast Guard, Washington, DC.
- (26) Klitchieff, J.M. (1951). On the Stability of Plates Reinforced by Longitudinal Ribs, J. Applied Mechanics, 18(4), pp. 221-268.
- (27) Krishnankutty, A. (2000), A Literature Review of Strength Models for Hull Girder Bending, specifically conducted for a project by UMCP, College Park, MD, and by UNO, New Orleans, LA.
- (28) Mansour, A. and Thayamball, 1994. .Probability-Based Ship Design: Loads and Load Combinations,. SSC-373, Ship Structures Committee, NTIS # PB94-188208, Springfield, Virginia.
- (29) Mansour, A.E., Wirsching, P.H., and White, G.J., and Ayyub, B. M., 1995. .Probability-Based Ship Design: Implementation of Design Guidelines, SSC 392, NTIS, Washington, D.C., 200 pages.
- (30) Paik, J. K. and Lee, J. M., 1996. .An Empirical Formulation for Predicting the Ultimate Compression Strength of Plates and Stiffened Plates, Trans. Society of Naval Architectures of Korea, Vol. 33, No.3, pp. 8-21 (in Korean).

- (31) Paik, J. K. and Thayamballi, A.K, 1997. .A benchmark Study on the Ultimate Strength Formulations of Stiffened Panels, Joint PNU-ABS Research Project, Final Report to the American Bureau of Shipping, by Pusan National University, Department of Naval Architecture and Ocean Engineering, Pusan.
- (32) Paik, J.K., Thayamballi, A.K. and Kim, B.J. (2001). Large Deflection Orthotropic Plate Approach to Develop Ultimate Strength Formulations for Stiffened Panels under Combined Biaxial Compression/Tension and Lateral Pressure, Thin-Walled Structures, Vol.39, No.3, pp.215-246
- (33) Paik, J.K., Thayamballi, A.K., che, J.S. (1996) .Ultimate Strength of Ship Hulls Under Combined Vertical Bending, Horizontal Bending, and Shearing Forces.. Transactions of the Society of Naval Architects and Marine Engineers, 104, 31-59.
- (34) Paik, J.K., Thayamballi, A.K., Wang, G. and Kim, B.J. (2000). On Advanced Buckling and Ultimate Strength Design of Ship Plating, Trans. SNAME, Vol.108.
- (35) Pradillon, J.Y., Quesnel, T., Toderan, C., and Rigo, P. (2001). Ultimate Strength of Longitudinally Stiffened Panels: Multi-criteria Comparative Analysis, Practical Design of Ships and Other Floating Structures, 2001, Elsevier, pp.1029-1035.
- (36) Rigo, P., Moan, T., Frieze, P.A. and Chryssanthopoulos, M. (1995). Benchmarking of Ultimate Strength Prediction for Longitudinally Stiffened Panels, Proc. of the 6th International Symposium on Practical Design of Ship and Mobile Units (PRADS'95), Vol.2, Seoul, September, pp. 869-882.
- (37) Sheikh, I.A., Grondin, G.Y., and Elwi, A.E. (2002). Stiffened Steel Plates under Uniaxial Compression, J. of Constructional Steel Research, Vol.58, pp.1061-1080.
- (38) Smith, C.S. (1976). Compressive Strength of Welded Steel Ship Grillages, Trans. RINA, Vol.118, pp.325-359.
- (39) Smith, C.S., Anderson, N., Chapman, J.C., Davidson, P.C. and Dowling, P.J. (1992). Strength of Stiffened Plating under Combined Compression and Lateral Pressure, Trans. RINA, Vol.134, pp.131-147.
- (40) Smith, C.S., Davidson, P.C., Chapman, J.C., and Dowling, P.J. (1988). Strength and Stiffness of Ship's Plating under In-Plane Compression and Tension, Trans. RINA, Vol.130:277-296.
- (41) Soares, C.G., and Gordo, J.M. (1997) .Interaction Equation for the Collapse of Tankers and Containerships Under Combined Bending Moments, Journal of Ship Research, SNAME 41(3), 230-240.
- (42) Steen, E., Ostvold, T.K., Chapman, J.C., Valsgård, S. (2001). A New Design Model for Ultimate and Buckling Strength Assessment of Stiffened Panels, Practical Design of Ships and Other Floating Structures, 2001, Elsevier, pp.1021-1027.
- (43) Timoshenko, S.P., Gere, J.M. (1961). Theory of Elastic Stability, 2nd edition, McGraw
- (44) Wang, X, Moan, T, (1997) Ultimate Strength Analysis of Stiffened Panels in Ships Subjected to Biaxial and Lateral Loading, International Journal of Offshore and Polar Engineering, v 7, n 1, Mar, 1997, p 22-29

- (45) Yao, T., Fujikubo, M., Yanagihara, D., (1997) Buckling/Plastic Collapse Behaviour and Strength of Stiffened Plates under Thrust. International Journal of Offshore and Polar Engineering, v 7, n 4, Dec, 1997, p 285-292
- (46) Zha, Y, Moan, T., (2003) Experimental and Numerical Prediction of Collapse of Flatbar Stiffeners in Aluminum Panels, Journal of Structural Engineering, v 129, n 2, February, 2003, p 160-168

## SHIP STRUCTURE COMMITTEE LIAISON MEMBERS

### LIAISON MEMBERS

American Society of Naval Engineers	Captain Dennis K. Kruse (USN Ret.)
Bath Iron Works	Mr. Steve Tarpay
Colorado School of Mines	Dr. Stephen Liu
Edison Welding Institute	Mr. Rich Green
International Maritime Organization	Mr. Igor Ponomarev
Int'l Ship and Offshore Structure Congress	Dr. Alaa Mansour
INTERTANKO	Mr. Dragos Rauta
Massachusetts Institute of Technology	
Memorial University of Newfoundland	Dr. M. R. Haddara
National Cargo Bureau	Captain Jim McNamara
National Transportation Safety Board - OMS	Dr. Jack Spencer
Office of Naval Research	Dr. Yapa Rajapaksie
Oil Companies International Maritime Forum	Mr. Phillip Murphy
United States Coast Guard Academy	Commander Kurt Colella
United States Merchant Marine Academy	
United States Naval Academy	Dr. Ramswar Bhattacharyya
University of British Columbia	Dr. S. Calisal
University of California Berkeley	Dr. Robert Bea
Univ. of Houston - Composites Eng & Appl.	
University of Maryland	Dr. Bilal Ayyub
University of Michigan	Dr. Michael Bernitsas
Virginia Polytechnic and State Institute	Dr. Alan Brown
Webb Institute	Prof. Roger Compton
Samsung Heavy Industries, Inc.	Dr. Satish Kumar

## RECENT SHIP STRUCTURE COMMITTEE PUBLICATIONS

Ship Structure Committee Publications on the Web - All reports from SSC 392 and forward are available to be downloaded from the Ship Structure Committee Web Site at URL:

<http://www.shipstructure.org>

SSC 445 and below are available on the SSC CD-ROM Library. Visit the National Technical Information Service (NTIS) Web Site for ordering information at URL:

<http://www.ntis.gov>

SSC Report Number	Report Bibliography
SSC 445	Structural Survivability of Modern Liners, Iversen R. 2005
SSC 444	In-Service Non-Destructive Estimation of the Remaining Fatigue Life of Welded Joints, Dexter R.J., Swanson K.M., Shield C.K. 2005
SSC 443	Design Guidelines for Doubler Plate Repairs on Ship Structures Sensharma P.K., Dinovitzer A., Traynham Y. 2005
SSC 442	Labor-Saving Passive Fire Protection Systems For Aluminum And Composite Construction E. Greene, 2005
SSC 441	Fire Degradation, Failure Prediction And Qualification Methods For Fiber Composites R. Asaro, M. Dao, 2005
SSC 440	Deterioration of Structural Integrity Due to Chemical Treatment of Ballast Water S. Tiku, 2005
SSC 439	Comparative Structural Requirements For High Speed Crafts K. Stone, 2005
SSC 438	Structural Optimization for Conversion of Aluminum Car Ferry to Support Military Vehicle Payload, R.Kramer, 2005
SSC 437	Modeling Longitudinal Damage in Ship Collisions A.J. Brown, JAW Sajdak 2005
SSC 436	Effect of Fabrication Tolerances on Fatigue Life of Welded Joints A. Kendrick, B. Ayyub, I. Assakkaf 2005
SSC 435	Predicting Stable Fatigue Crack Propagation in Stiffened Panels R.J. Dexter, H.N. Mahmoud 2004
SSC 434	Predicting Motion and Structural Loads in Stranded Ships Phase 1 A.J. Brown, M. Simbulan, J. McQuillan, M. Gutierrez 2004