

**FINAL REPORT**

(Project SR-99)

on

**Part I: THE FUNDAMENTAL FACTORS INFLUENCING THE BEHAVIOR OF  
WELDED STRUCTURES UNDER CONDITIONS OF MULTIAXIAL STRESS  
AND VARIATIONS OF TEMPERATURE.**

**Part II: THE EFFECT OF SUBCRITICAL HEAT TREATMENT ON THE TRANSITION  
TEMPERATURE OF A LOW CARBON SHIP PLATE STEEL.**

by

W. M. Baldwin, Jr., and E. B. Evans  
CASE INSTITUTE OF TECHNOLOGY

Transmitted through

**NATIONAL RESEARCH COUNCIL'S  
COMMITTEE ON SHIP STEEL**

Advisory to

**SHIP STRUCTURE COMMITTEE**

**Division of Engineering and Industrial Research**

National Academy of Sciences - National Research Council

Washington, D. C.

**November 6, 1953**

# SHIP STRUCTURE COMMITTEE

## MEMBER AGENCIES:

BUREAU OF SHIPS, DEPT. OF NAVY  
MILITARY SEA TRANSPORTATION SERVICE, DEPT. OF NAVY  
UNITED STATES COAST GUARD, TREASURY DEPT.  
MARITIME ADMINISTRATION, DEPT. OF COMMERCE  
AMERICAN BUREAU OF SHIPPING

## ADDRESS CORRESPONDENCE TO:

SECRETARY  
SHIP STRUCTURE COMMITTEE  
U. S. COAST GUARD HEADQUARTERS  
WASHINGTON 25, D. C.

November 6, 1953

Dear Sir:

As part of its research program related to the improvement of hull structures of ships, the Ship Structure Committee is sponsoring an investigation on the fundamental factors influencing the behavior of welded structures under conditions of multiaxial stress and variations of temperature at the Case Institute of Technology. Herewith is a copy of the Final Report, SSC-64, of the investigation, entitled "Part I: The Fundamental Factors Influencing the Behavior of Welded Structures under Conditions of Multiaxial Stress. Part II: The Effect of Subcritical Heat Treatment on the Transition Temperature of a Low Carbon Ship Plate Steel," by W. M. Baldwin, Jr., and E. B. Evans.

The project has been conducted with the advisory assistance of the Committee on Ship Steel of the National Academy of Sciences-National Research Council.

Any questions, comments, criticism or other matters pertaining to the Report should be addressed to the Secretary, Ship Structure Committee.

This Report is being distributed to those individuals and agencies associated with and interested in the work of the Ship Structure Committee.

Yours sincerely,



K. K. COWART  
Rear Admiral, U. S. Coast Guard  
Chairman, Ship Structure Committee

Final Report  
(Project SR-99)

on

Part I: The Fundamental Factors Influencing the Behavior  
of Welded Structures under Conditions of Multiaxial  
Stress and Variations of Temperature.

Part II: The Effect of Subcritical Heat Treatment on the  
Transition Temperature of a Low Carbon Ship  
Plate Steel.

by

W. M. Baldwin, Jr.  
E. B. Evans

CASE INSTITUTE OF TECHNOLOGY

under

Department of the Navy  
Bureau of Ships NObs - 45470  
BuShips Project No. NS-011-078

for

SHIP STRUCTURE COMMITTEE

	<u>Page</u>
Introduction . . . . .	1
PART I: The Fundamental Factors Influencing the Behavior of Welded Structures.	
Selection of Eccentric Notch Tensile Test for Evaluating the Effects of Welding . . . . .	3
Studies with Eccentric Notch Tensile Specimen . . . . .	6
Steel Comparison (A and C Steels). . . . .	6
Preheat and Postheat . . . . .	11
Specimen Size. . . . .	11
Inhomogeneity of Plate . . . . .	13
Selected Locations in Weld Metal . . . . .	13
Comparison with Concentric Notch and Unnotched Tensile Tests. . . . .	15
Metallurgical Structures. . . . .	17
Hardness Surveys. . . . .	19
Temperature Measurements. . . . .	21
Subcritical Heat Treatment (Preliminary Work) . . . . .	21
Part II: The Effect of Subcritical Heat Treatment on the Transition Temperature of a Low Carbon Ship Plate Steel.	
Isothermal Studies. . . . .	25
Air Cooled . . . . .	25
Furnace Cooled . . . . .	27
Water Quenched . . . . .	27
Effect of Heating Medium. . . . .	29
Quench-Aging Studies. . . . .	29
Microstructures . . . . .	31
Cooling Rates . . . . .	34
Interpretation of Results: Weldments and Subcritically Heat Treated Plate . . . . .	36
Appendix A . . . . .	41
Appendix B . . . . .	45
Bibliography . . . . .	48

LIST OF FIGURES

<u>No.</u>	<u>TITLE</u>	<u>PAGE</u>
1.	Notch Properties as a Function of Strength Level for Various Steels (2). . . . .	5
2.	Relations between Concentric and Eccentric Notch Strength Ratios and Notch Ductility . . . . .	5
3.	Eccentric Notch Strength of the Unaffected Base Plate as a Function of Testing Temperature. . . . .	8
4.	Eccentric Notch Strength of the Unaffected Base Plate as a Function of Testing Temperature. . . . .	8
5.	Distribution of Eccentric Notch Strength at -60°F . . . . .	9
6.	Distribution of Eccentric Notch Strength at -70°F . . . . .	9
7.	Transition Curves of the Region of Lowest Ductility for Steels "A" and "C". . . . .	10
8.	Variation of Transition Temperature with Distance from the Weld Centerline . . . . .	10
9.	Transition Curves of the Unaffected Base Plate of Steel "C" for Three Welding Conditions. . . . .	12
10.	Distribution of Eccentric Notch Strength of "C" Steel at -80°F for Three Welding Conditions . . . . .	12
11.	Transition Curves of the Region of Lowest Ductility for Three Welding Conditions. . . . .	12
12.	Effect of Specimen Section Size on the Distribution of Eccentric Notch Strength at -70°F . . . . .	14
13.	Distribution of Eccentric Notch Strength at -80°F . . . . .	14
14.	Comparison of the Eccentric and Concentric Notch Properties as a Function of Testing Temperature Midthickness Tests of "A" Steel Base Plate. . . . .	16
15.	Distribution of Concentric and Eccentric Notch Properties at Various Low Temperatures--Midthickness tests of "A" Steel Weldments, (100°F Preheat and Interpass Temperatures) . . . . .	16

<u>No.</u>	<u>TITLE</u>	<u>PAGE</u>
16.	Regular Tensile Properties of "A" Steel as a Function of Testing Temperature . . . . .	18
17.	Distribution of Hardness across Weld at Various Positions Throughout the Thickness of the Plate . . . . .	20
18.	Distribution of Microhardness Values at the Mid-thickness of 3/4" Plate Weldments of Steels "C" and "A" . . . . .	20
19.	Maximum Temperatures Reached during Welding for Two Welding Conditions. . . . .	22
20.	Heating and Cooling Curves in the Region of Lowest Ductility for Two 6 Pass Weldments .	22
21.	Heating and Cooling Curves in the Region of Lowest Ductility for Two Welding Conditions	24
22.	Effect of Subcritical Heating and Cooling on the Eccentric Notch Strength of Unaffected Base Plate. . . . .	24
23.	Eccentric Notch Tensile Transition Temperatures of "C" Steel as a Function of Time at Various Subcritical Temperatures. Air Cooled.	26
24.	Charpy V-Notch Transition Temperature as Function of Time at Subcritical Temperatures. Air Cooled. Plate II . . . . .	26
25.	Transition Temperatures of "C" Steel as a Function of Time at Subcritical Temperatures. Water Quenched and Aged One Month at Room Temperature. Plate II. . . . .	28
26.	Transition Temperatures of "C" Steel Resulting from Various Subcritical Heat Treatments in Nitrate Salt Bath and in Air, Employing an Air Cool. . . . .	30
27.	Transition Temperatures of "C" Steel Resulting from Heating at 1100°F for Various Times in Nitrate Salt Bath and in Air, Employing a Water Quench. Aged One Month at Room Temperature. . . . .	30

<u>No.</u>	<u>TITLE</u>	<u>PAGE</u>
28.	Effect of Room Temperature Aging Time on the Transition Temperature and Hardness of "C" Steel after Water Quenching from Temperatures Indicated. . . . .	32
29.	Effect of Various Aging Times and Temperatures on the Hardness of "C" Steel after Water Quenching from 1300°F . . . . .	32
30.	Summary Curves Showing Effect of Various Aging Temperatures and Times on the Transition Temperature and Hardness of "C" Steel. Specimens Water Quenched from 1300°F before Aging. . . . .	33
31.	Solution and Room Temperature Aging Effects on the Hardness and Impact Properties of "C" Steel. . . . .	33
32.	Comparison of Cooling Curves in the Region of Lowest Ductility for Two Welding Conditions with Those Obtained with Heat Treated Test Specimens. . . . .	35
A1.	Test Specimens. . . . .	42
A2.	Method of Loading to Obtain 1/4 Inch Eccentricity. (Eccentricity and the Position of Fixtures are Exaggerated.). . . . .	43
A3.	Plate Preparation . . . . .	43
A4.	Welding Procedure . . . . .	43
A5.	Location of Eccentric Notch Specimen at the Surface Level . . . . .	44
A6.	Location of Unnotched and Notched Specimens at the Midthickness of Weldment. . . . .	44
A7.	Preparation of Charpy V-Notch and Notch Tensile Specimens from "C" Steel Plate . . . . .	44

## INTRODUCTION

This is the final report on a project sponsored by the Ship Structure Committee under U. S. Navy Contract NObs-45470 and summarizes the work done in the period from July 1, 1947 to December 31, 1952. Five Technical Progress Reports<sup>(1,2,3,4,5)</sup> covered the work completed under this contract.

Three progress reports<sup>(1,2,3)</sup> were issued entitled, "The Fundamental Factors Influencing the Behavior of Welded Structures under Conditions of Multiaxial Stress, and Variations of Temperature, Stress Concentration, and Rates of Strain". The major objectives were to determine the relative notch toughness of various zones in commercially welded ship plate steel, and, if such zones could be isolated to determine the dependence of the notch behavior upon material, variations in the welding process, and heat treatment. Eccentric notch tensile tests at various low temperatures were used to evaluate the ductility of a small volume of metal from any position in the weldment. A summary of the work toward these objectives is presented in Part I of this report.

Two progress reports<sup>(4,5)</sup> were submitted under the title, "The Effect of Subcritical Heat Treatment on the Transition Temperature of a Low Carbon Ship Plate Steel". The principal objectives were to (1) give an insight into the basic mechanism which was responsible for the brittle zone found in the subcritically heated region in weldments; (2) determine the



maximum embrittlement possible in base plate by subcritical heat treatment; and (3) suggest possible methods of minimizing or eliminating this embrittlement in base plate which may be applicable to weldments. This work is presented in Part II.

The important findings of the two different phases of the investigation are integrated to show that the quenching mechanism appears to be responsible for the brittle zone outside the weld area of low carbon ship plate weldments.

PART I: THE FUNDAMENTAL FACTORS INFLUENCING THE BEHAVIOR OF  
WELDED STRUCTURES

Selection of Eccentric Notch Tensile Test for Evaluating the  
Effects of Welding

Numerous investigations have shown that steel structures may fail in a brittle manner when subjected to certain service conditions. The conditions associated with brittle failure include multiaxial stresses, stress concentration, low temperature, section size, and rate of loading.

A combination of these embrittling factors may reduce the ductility to a low value. The ductility then dictates a structure's resistance to failure rather than the strength, because it is known that only a small amount of energy is required to propagate a crack through a region of low ductility.

In view of the fact that the number of brittle failures in ships had increased with the adoption of welding techniques, it was felt that the welding process altered the properties of the steel. Many investigations employing a number of different specimens have shown that the ductility of a weldment is lower than the ductility of the steel of which the weldment is made.

In selecting a test for locating zones of lowered ductility in weldments, a specimen was needed which would constitute a very fine probe (these critical zones were expected to be small), and still include some of the previously mentioned embrittling factors. Such a test would serve to lower the ductility of the entire plate to such a point that the

critical regions could be located.

The eccentric notch tensile test met these requirements in that a very small volume of metal controlled the reaction of the specimen<sup>\*</sup>; the embrittling factors of eccentric loading, multiaxial stress, and a stress-raiser were present; and the factor of low temperature could be added.

This specimen was used in previous investigations to differentiate among low alloy steels (heat treated to the same strength levels) which were known to have different service properties<sup>(6,7)</sup>. In Fig. 1 the properties of four steels were compared, at room temperature, by means of concentric and eccentric notch tests. The data used to draw these comparison curves were obtained from Fig. 2, a plot of notch strength ratio<sup>\*\*</sup> as a function of ductility. The concentric notch strength seemed to be dependent upon the ductility up to about two per cent, whereas the eccentric notch strength extended the dependence of the notch strength upon ductility up to approximately ten per cent by the addition of another embrittling factor, that of eccentric loading.

From Fig. 1, it can be seen that the eccentric notch test was able to detect differences in the four steels, and rate them in the same order as the concentric notch test. The

---

<sup>\*</sup>The fiber at the notch bottom was subjected to the maximum tensile stress, and was the fiber in which fracture initiated.

<sup>\*\*</sup>Notch strength ratio is defined as the ratio between the notch strength and the tensile strength.

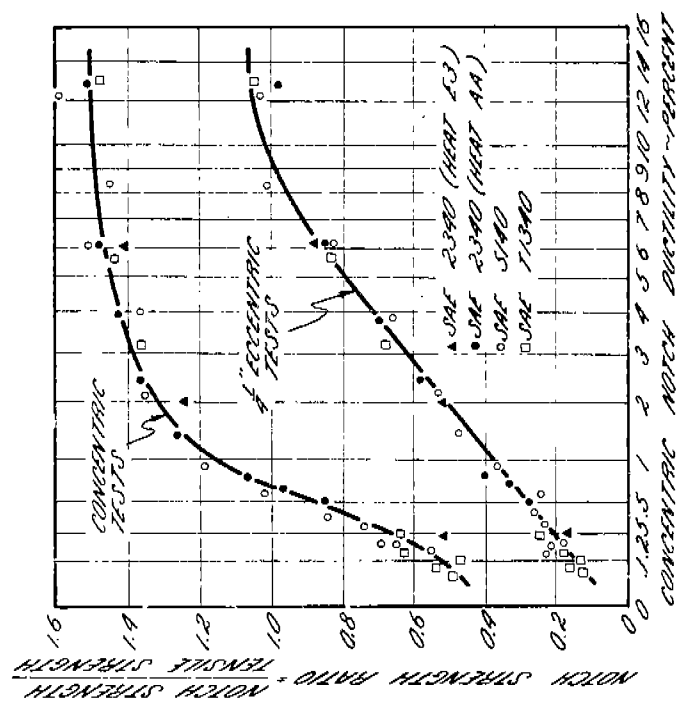

FIG. 2: RELATIONS BETWEEN CONCENTRIC AND PERCENTRIC NOTCH STRENGTH RATIOS AND NOTCH DUCTILITY.

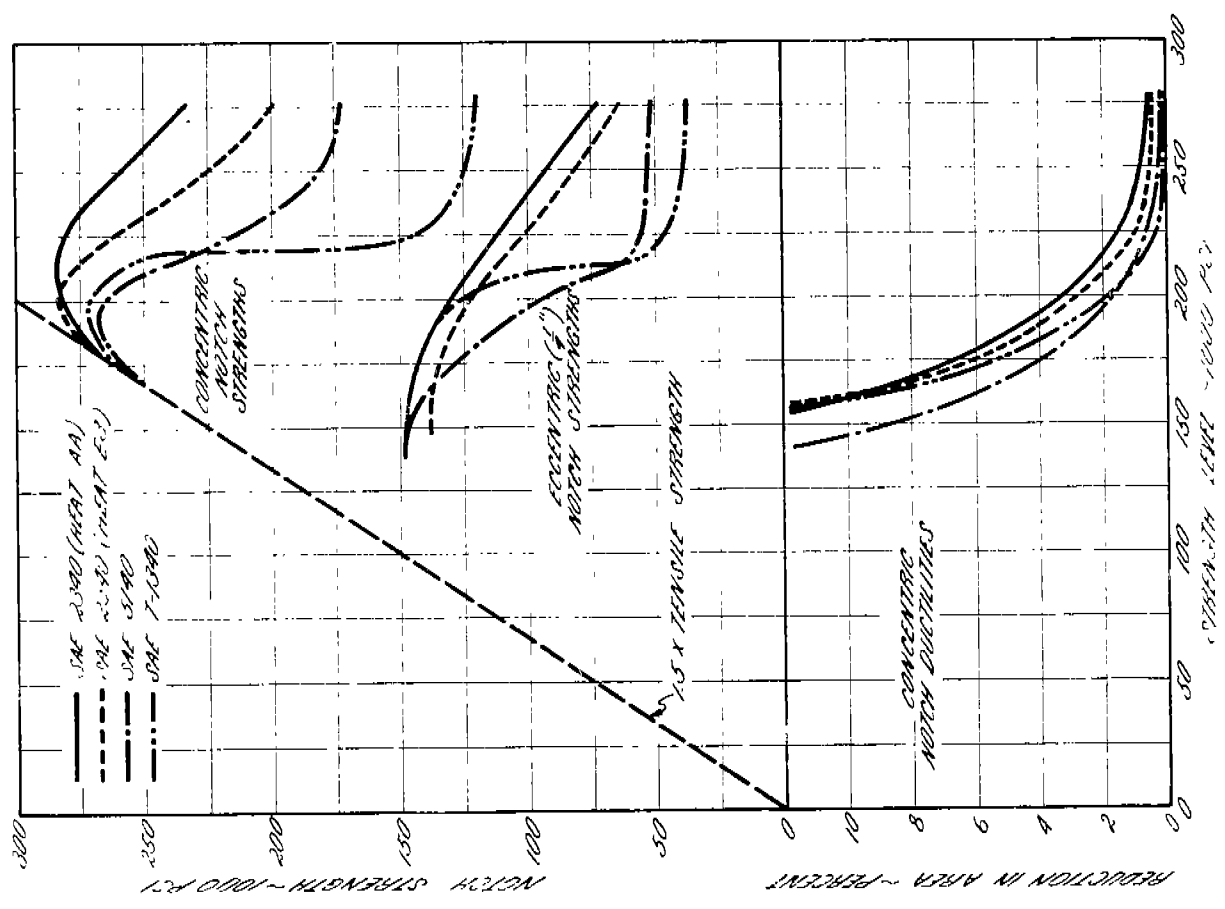

FIG. 1: NOTCH PROPERTIES AS A FUNCTION OF STRENGTH LEVEL FOR MARBORG STEELS (2).

ductility of ship plate steel is too high to show up any regions of lowered ductility at room temperature, but with the added embrittling factor of low temperature the eccentric notch tensile test can be expected to detect differences in the various zones encountered in a weldment.

The specimen design is shown in Fig. A-1\* and the method of conducting a test illustrated in Fig. A-2.

### Studies with Eccentric Notch Tensile Specimen

The ship steels selected for study were A and C project steels because they had been shown to have widely different transition temperatures, although of the same approximate composition. The properties reported for these steels are listed in Table B-1. Weldments were made of these steels at the Battelle Memorial Institute under closely controlled conditions. The details of the plate preparation and welding procedure are given in Figs. A-3 and A-4, respectively, and the welding data in Table B-2. All specimens were taken from the weldments as shown in Figs. A-5 and A-6, so that the long axis was perpendicular to the rolling direction. About one month elapsed between time of welding and testing.

### Steel Comparison

The first tests were conducted on specimens from the mid-thickness level of weldments of A and C steel made with 100°F

---

\*The letter "A" or "B" preceding the number refers to the corresponding Appendix.

preheat and interpass temperature. The transition temperature ranges for the unaffected base plate (2 inches or more from the weld centerline) are shown in Fig. 3 for C steel, and in Fig. 4 for A steel. The superior properties of A steel were evident in a lower transition temperature\* ( $-80^{\circ}\text{F}$ ), as compared to  $-65^{\circ}\text{F}$  for C steel. The same relative rating was found in the results of other investigations.

For both steels the distribution of eccentric notch strength at selected low temperatures and at various distances from the weld centerline showed the presence of a minimum at 0.3--0.4 inch from the weld centerline and a maximum in the vicinity of the weld junction (0.1--0.2 inch from the weld centerline). The minimum and maximum positions can be seen in the distribution at  $-60^{\circ}\text{F}$  for C steel and at  $-70^{\circ}\text{F}$  for A steel in Figs. 5 and 6, respectively. A comparison of the average transition curves determined for the position of minimum ductility for both steels, Fig. 7, showed that the transition temperature for C steel ( $-20^{\circ}\text{F}$ ) was about  $20^{\circ}\text{F}$  higher than that for A steel ( $-40^{\circ}\text{F}$ ).

More complete data on the C steel weldment showed that the weld metal and the location of the maximum (0.1--0.2 inch from the weld centerline) did not go through a transition in the range of testing temperatures which were used. However, the relation between transition temperature and distance from weld centerline can be represented as shown in Fig. 8. The zone of minimum ductility was definitely defined by its high transition temperature.

---

\*Transition temperature is here defined as the temperature at the vertical midpoint of the average notch strength curve (dashed lines in the figures).

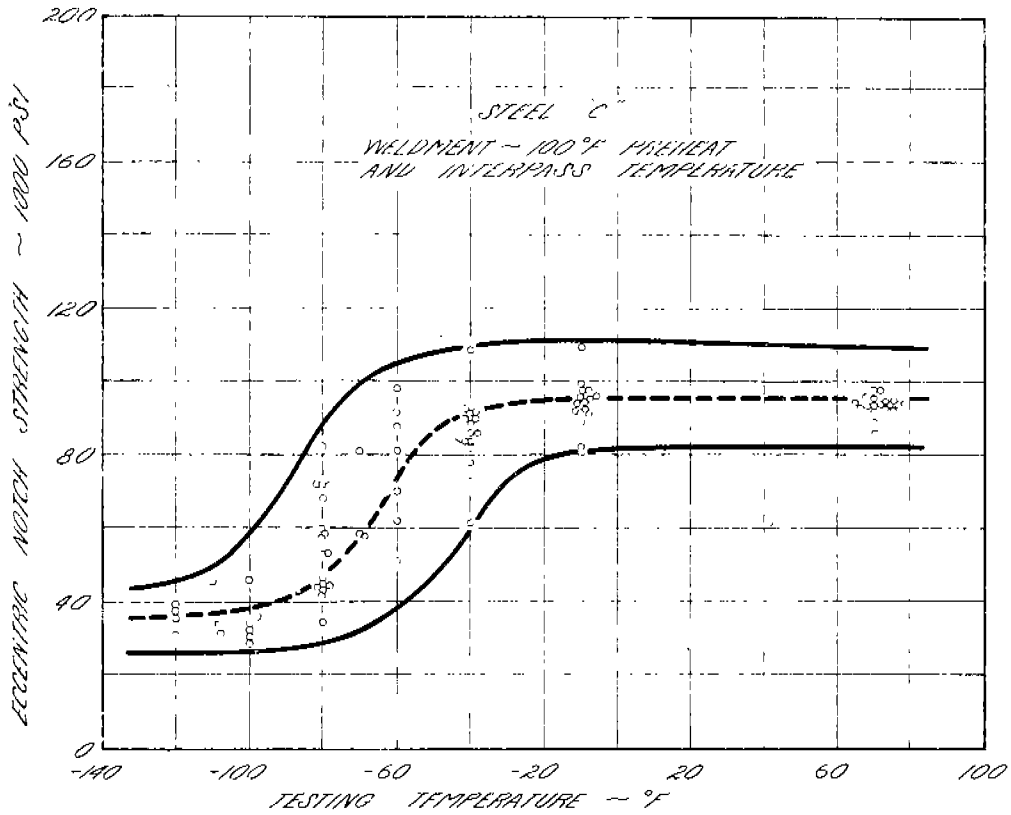

FIG. 3: ECCENTRIC NOTCH STRENGTH OF THE UNAFFECTED BASE PLATE AS A FUNCTION OF TESTING TEMPERATURE.

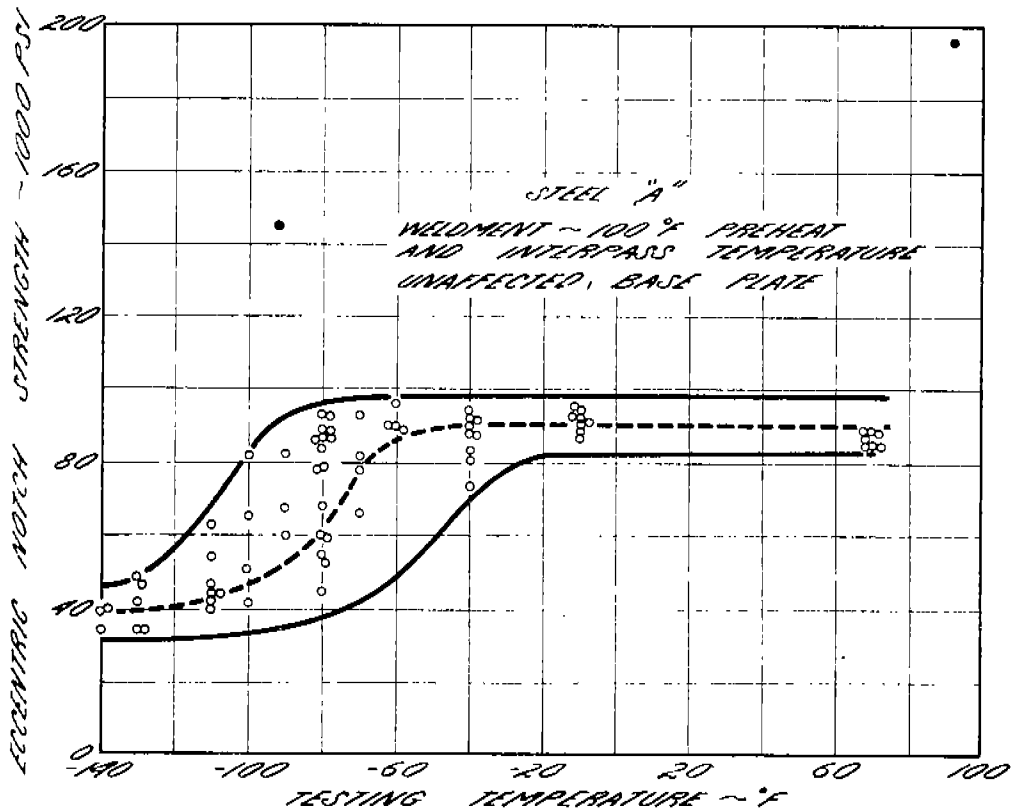

FIG. 4: ECCENTRIC NOTCH STRENGTH OF THE UNAFFECTED BASE PLATE AS A FUNCTION OF TESTING TEMPERATURE.

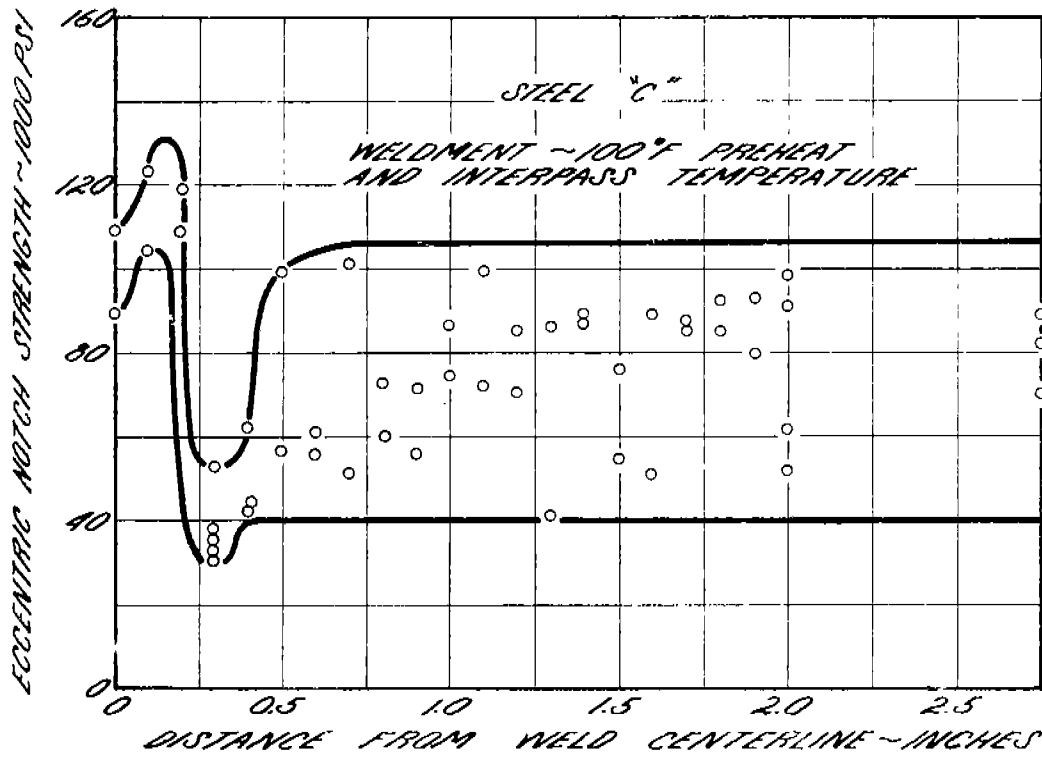

FIG. 5 : DISTRIBUTION OF ECCENTRIC NOTCH STRENGTH AT -60 °F

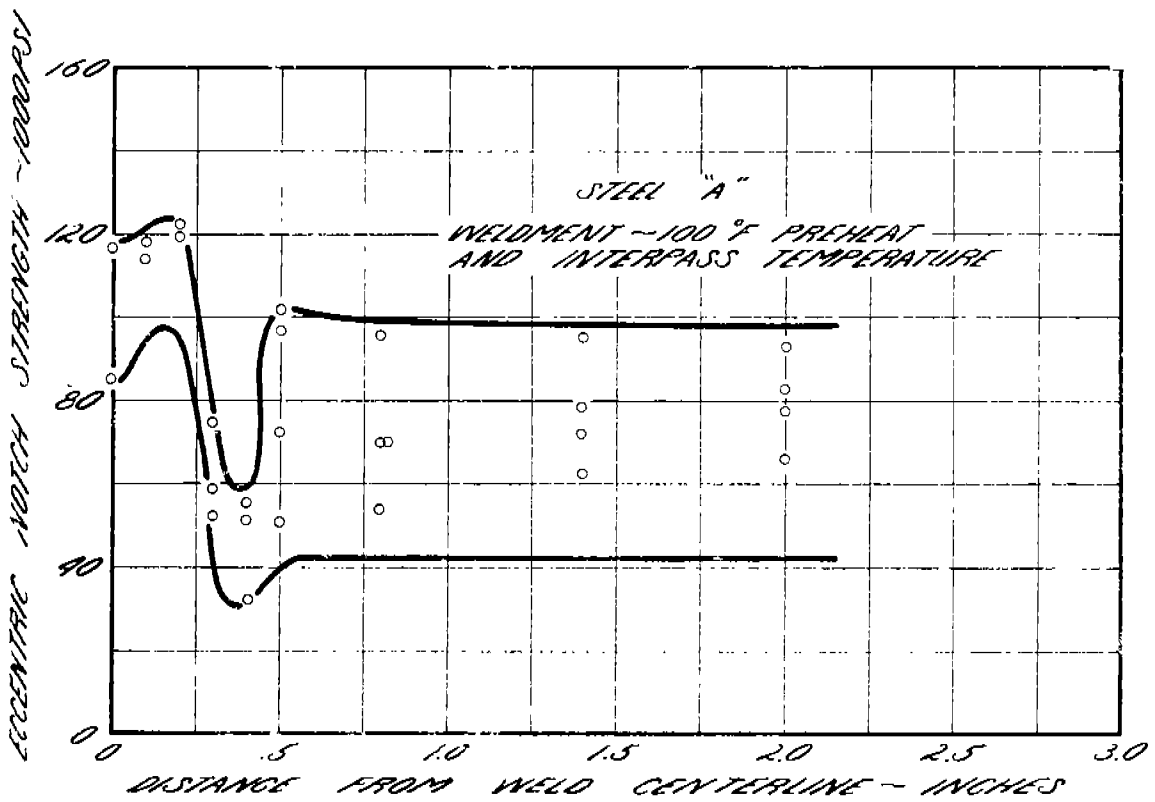

FIG. 6 : DISTRIBUTION OF ECCENTRIC NOTCH STRENGTH AT -70 °F



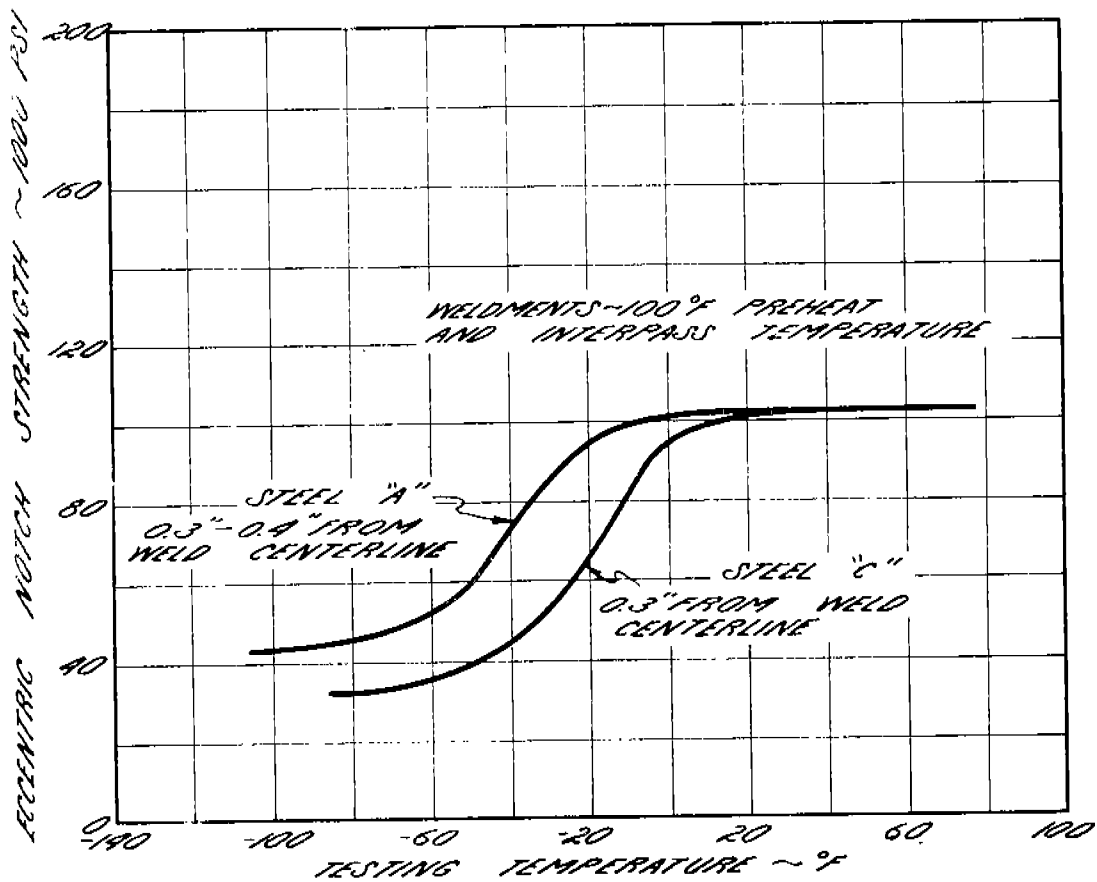

FIG. 7: TRANSITION CURVES OF THE REGION OF LOWEST DUCTILITY FOR STEELS "A" AND "C."

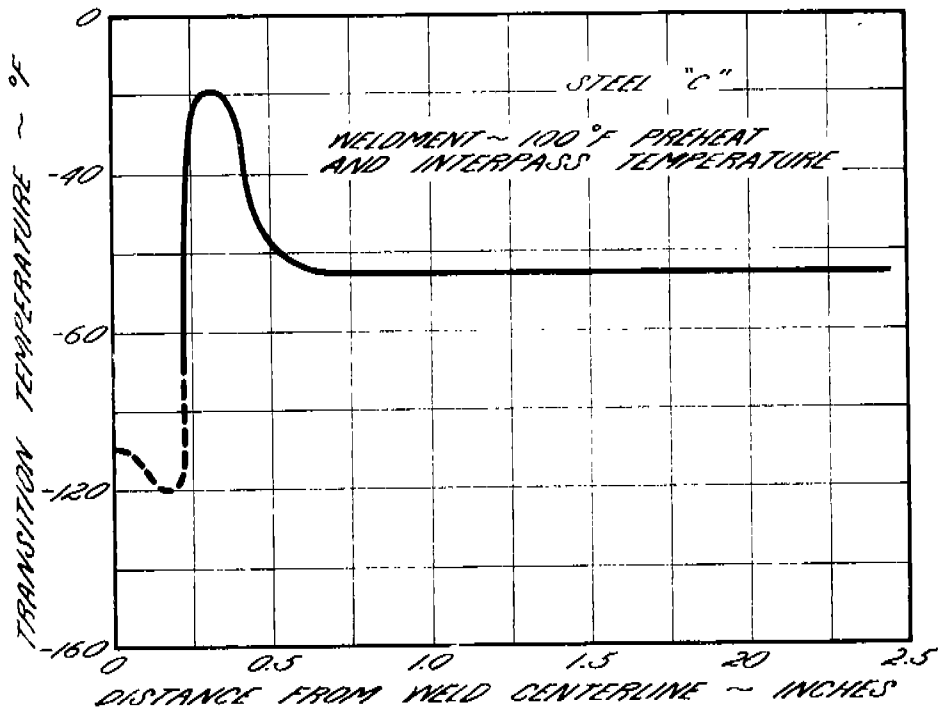

FIG. 8: VARIATION OF TRANSITION TEMPERATURE WITH DISTANCE FROM THE WELD CENTERLINE.

### Preheat and Postheat

In order to investigate the possible beneficial effects of preheating and postheating, weldments of C steel were made using a 400°F preheat and interpass temperature, and a postheat at 1100°F to a weldment made with 100°F preheat. A comparison of the average transition curves for the unaffected base plate, Fig. 9, showed that:

- (1) Data for the 100°F and 400°F preheat fitted on the same curve.
- (2) The postheated plate had almost the same transition temperature (-75°F) as the plates without postheat (-65°F).

A comparison of the distributions of notch strength across the welds determined at -80°F, Fig. 10, showed that the 400°F preheat brought about a definite improvement, and the 1100°F postheat a virtual elimination of the region of minimum ductility. The improvement was more clearly revealed in the average transition curves for this region, Fig. 11. The transition temperature of -20°F for the 100°F preheat was shifted to -45°F by the 400°F preheat, and to -70°F by the postheat treatment.

### Specimen Size

A smaller specimen than the one used might be expected to show up greater differences in notch strengths, because the changes in notch strength were very rapid as the distance from the weld centerline was increased from zero to 0.5 inch.

To check this, a number of smaller specimens (geometrically

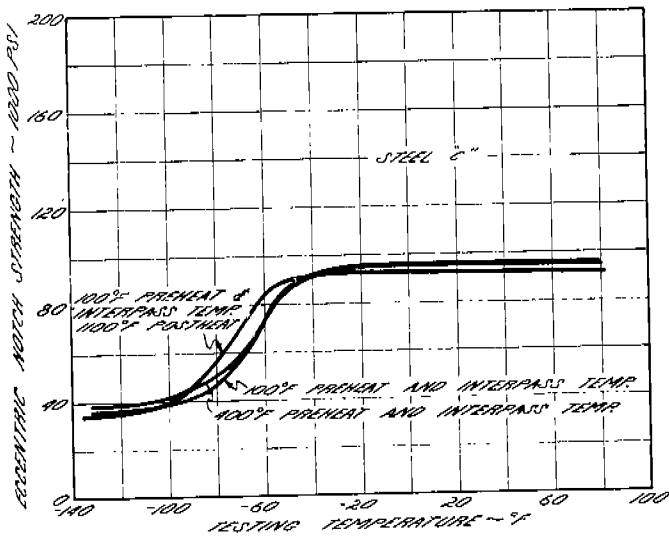

FIG. 9: TRANSITION CURVES OF THE UNAFFECTED BASE PLATE OF STEEL "C" FOR THREE WELDING CONDITIONS.

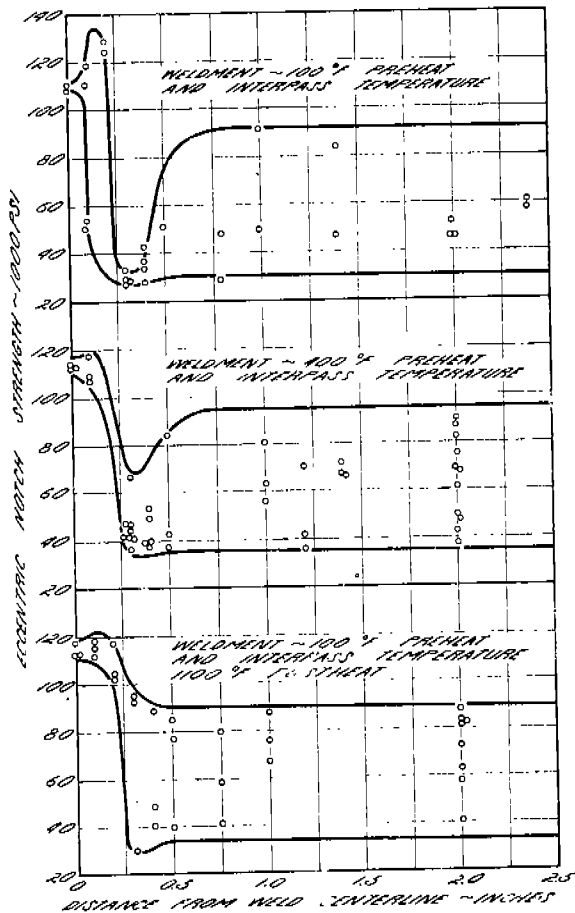

FIG. 10: DISTRIBUTION OF ECCENTRIC NOTCH STRENGTH OF "C" STEEL AT -80°F FOR THREE WELDING CONDITIONS.

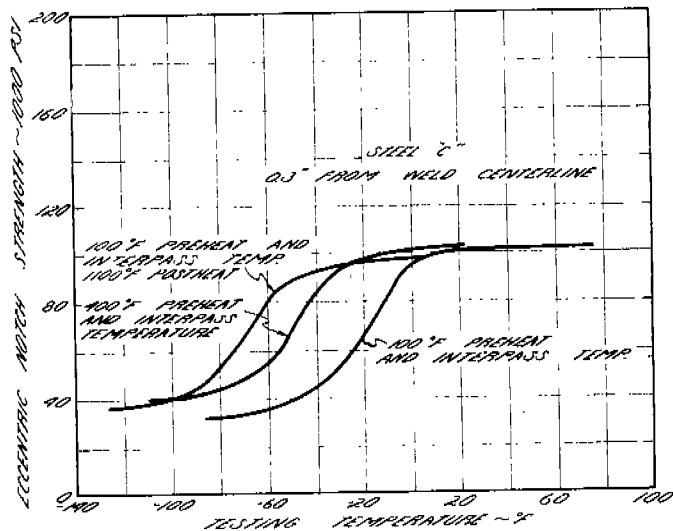

FIG. 11: TRANSITION CURVES OF THE REGION OF LOWEST DUCTILITY FOR THREE WELDING CONDITIONS.

similar but with the area of the notched section one-half that of the standard specimen) were taken from various locations of the A steel weldment and tested at  $-70^{\circ}\text{F}$ . These results superimposed on the results from standard specimens, Fig. 12, showed little difference. The small size then offered no advantage over the standard specimen.

#### Inhomogeneity of Plate

To determine any differences due to gross inhomogeneity of plate, tests were conducted on specimens taken from as close as possible to the plate surface of a C steel weldment made with  $100^{\circ}\text{F}$  preheat. The transition temperature of the unaffected base plate ( $-60^{\circ}\text{F}$ ) was but  $5^{\circ}\text{F}$  higher than that at the midthickness. The distribution of notch strength at various distances from the weld centerline for a testing temperature of  $-80^{\circ}\text{F}$ , Fig. 13, showed the same general behavior as the midthickness tests, but the minimum was shifted approximately 0.1 inch further from the weld centerline. This shift was to be expected due to the geometry of the double-V weld employed. This same behavior would be expected for the A steel at the surface level, based on the similar behavior of A and C steels at the midthickness.

#### Selected Locations in Weld Metal

In order to investigate further the possibility of zones of low ductility in the weld structure, a number of probe tests were conducted at  $-80^{\circ}\text{F}$  at the selected locations listed below:

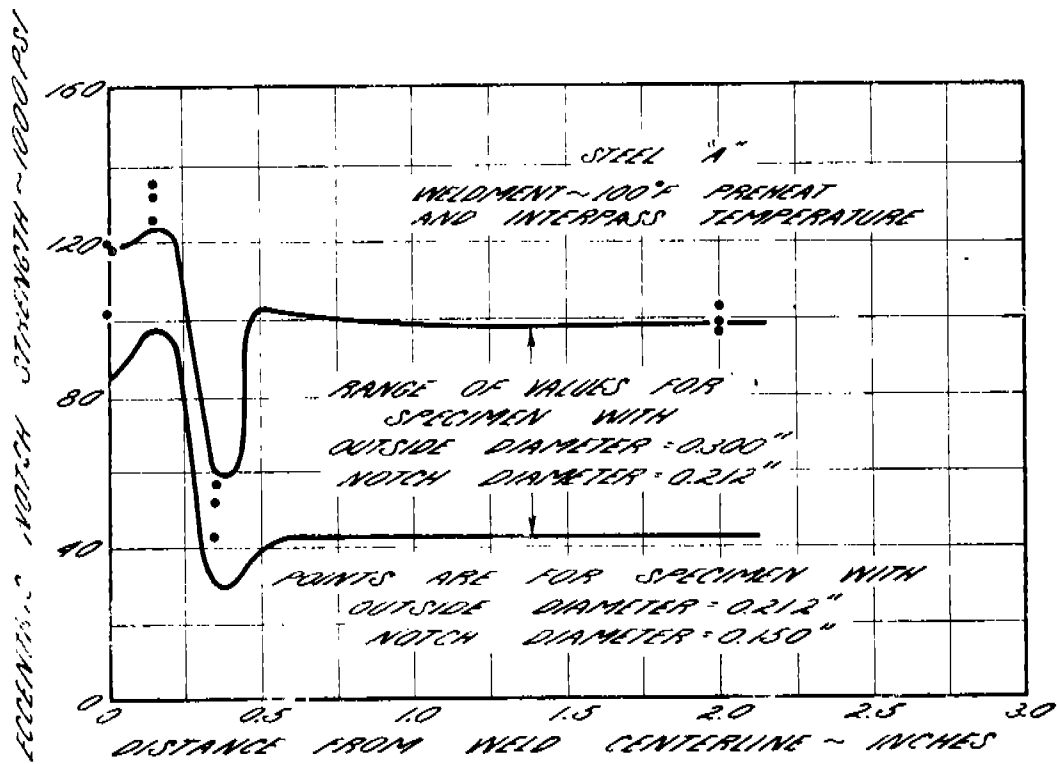

FIG. 12: EFFECT OF SPECIMEN SECTION SIZE ON THE DISTRIBUTION OF ECCENTRIC NOTCH STRENGTH AT -70°F.

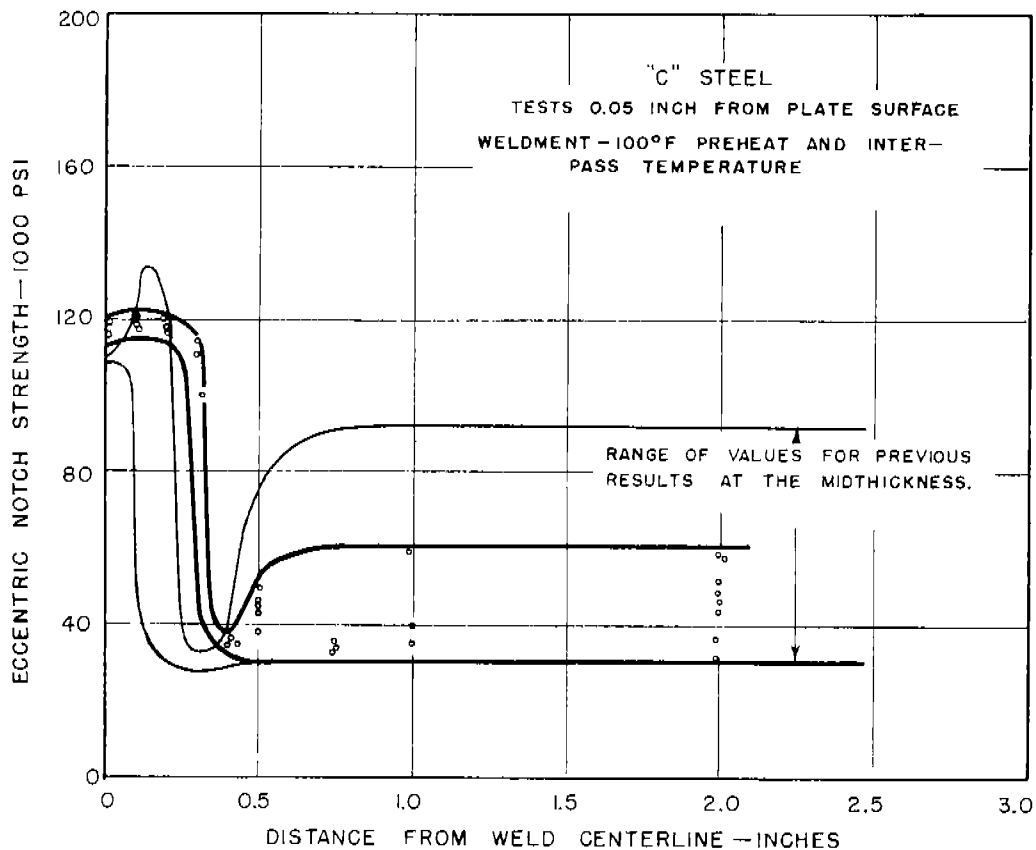

FIG. 13: DISTRIBUTION OF ECCENTRIC NOTCH STRENGTH AT -80°F

- A. The coarse structure at the weld junction from Pass 5.
- B. The coarse structure at the weld centerline approximately 0.03 inch from the plate surface.
- C. The coarse structure of Pass 2 at the weld centerline.

At these positions only high notch strength values were obtained, which, in conjunction with the high values previously obtained at the midthickness and surface levels, seemed to preclude the existence of low ductility in the weld metal.

#### Comparison with Concentric Notch and Unnotched Tensile Tests

To confirm that the eccentric notch strength was a measure of concentric notch ductility for shipplate steel as had been previously shown for low alloy steels (see Figs. 1 and 2), the results from a number of eccentric and concentric notch tensile tests from the midthickness level of the A steel weldment were compared.

In Fig. 14 the notch properties of the unaffected base plate are shown as a function of the testing temperature. The concentric notch strength appeared to be dependent upon the ductility up to a low value (say, two per cent), whereas the eccentric notch strength extended the dependence of the notch strength up to approximately 12 per cent. This was in good agreement with the previous findings.

In Fig. 15 the distribution of notch properties at various distances from the weld centerline is shown as a function of testing temperature. The concentric notch ductility showed up the region of low ductility (0.3--0.4 inch from the weld

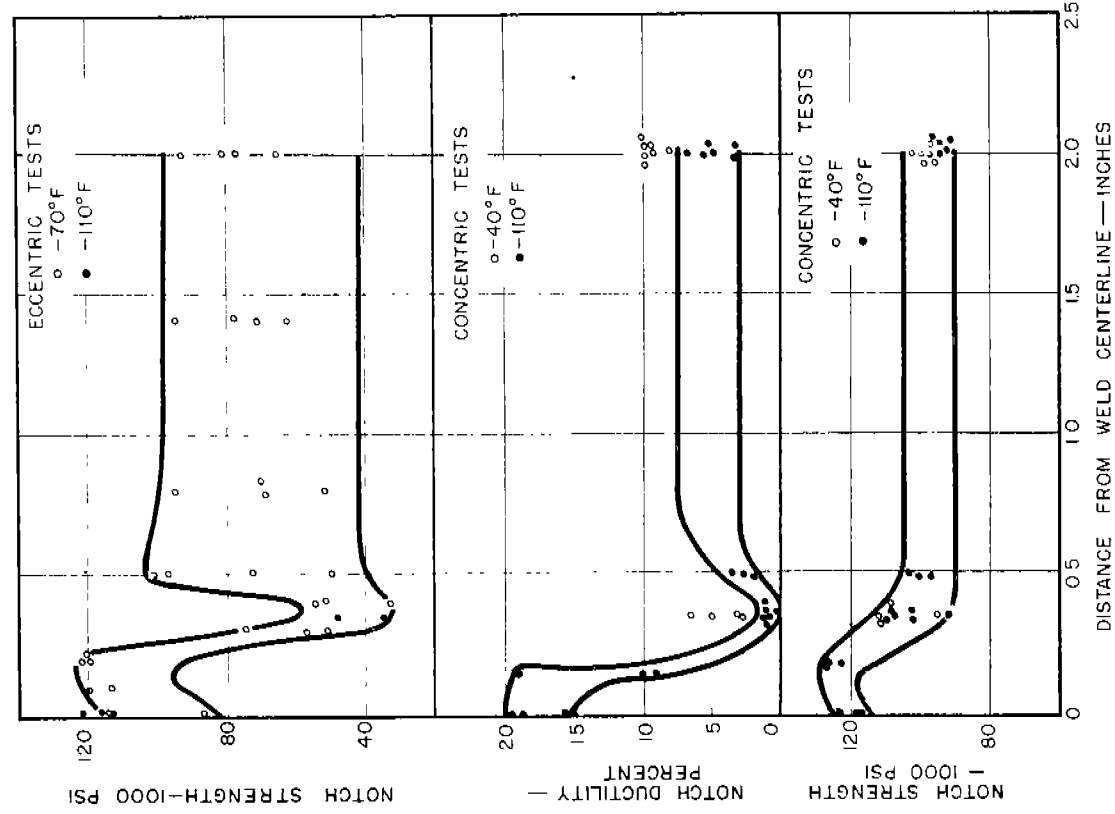

FIG. 15: DISTRIBUTION OF CONCENTRIC AND ECCENTRIC NOTCH PROPERTIES AT VARIOUS LOW TEMPERATURES—MIDTHICKNESS TESTS OF "A" STEEL WELDMENTS, (100°F PREHEAT AND INTERPASS TEMPERATURES)

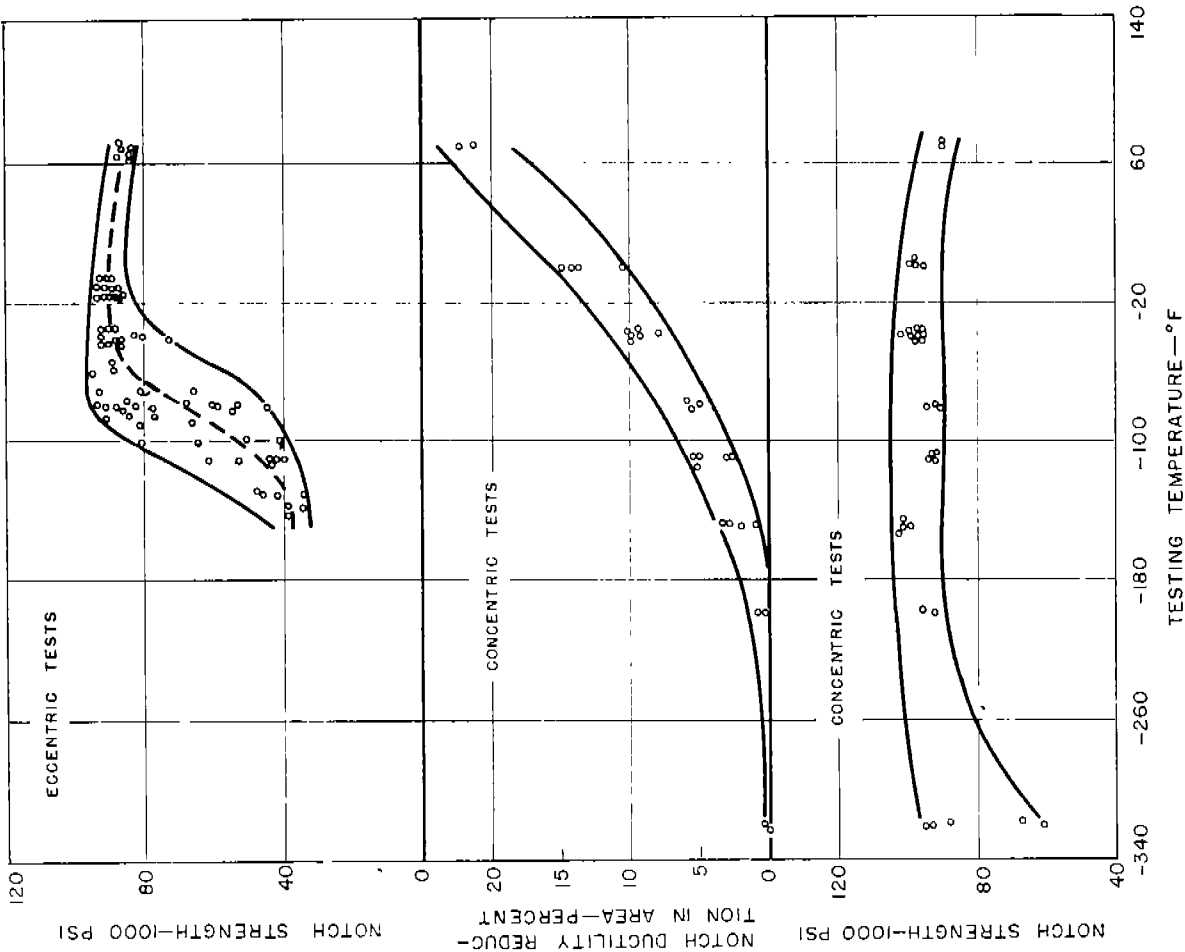

FIG. 14 COMPARISON OF THE ECCENTRIC AND CONCENTRIC NOTCH PROPERTIES AS A FUNCTION OF TESTING TEMPERATURE, MIDTHICKNESS TESTS OF "A" STEEL BASE PLATE.

centerline) in the same manner as the eccentric notch strength, whereas the concentric notch strength did not define this embrittled zone.

Unnotched tensile tests were also made on the same weldment to determine whether this test could be made sufficiently severe, by the use of very low temperatures, to detect ductility variations in ship plate steel. For the unaffected base plate, the tensile strength did not define a transition range; the reduction in area did define this range but only at very low temperatures, Fig. 16. The tensile properties at  $-110^{\circ}\text{F}$  of the zero and 0.35 inch positions were about the same as those for the unaffected base plate at the same temperature. From this limited data it appeared that the unnotched tensile test was not sufficiently severe to detect ductility variations in welded plate.

### Metallurgical Structures

A metallographic study of the structural zones at the mid-thickness level of the C steel weldment made with  $100^{\circ}\text{F}$  preheat revealed that the weld junction was defined by a sudden large change in grain size at 0.08 inch from the weld centerline.

With increasing distance from the weld centerline, the grain size of this structure which was cooled from above the upper critical decreased. The structure resulting from transformation from the temperature range between the upper and lower critical merged into the structure of the parent plate at about



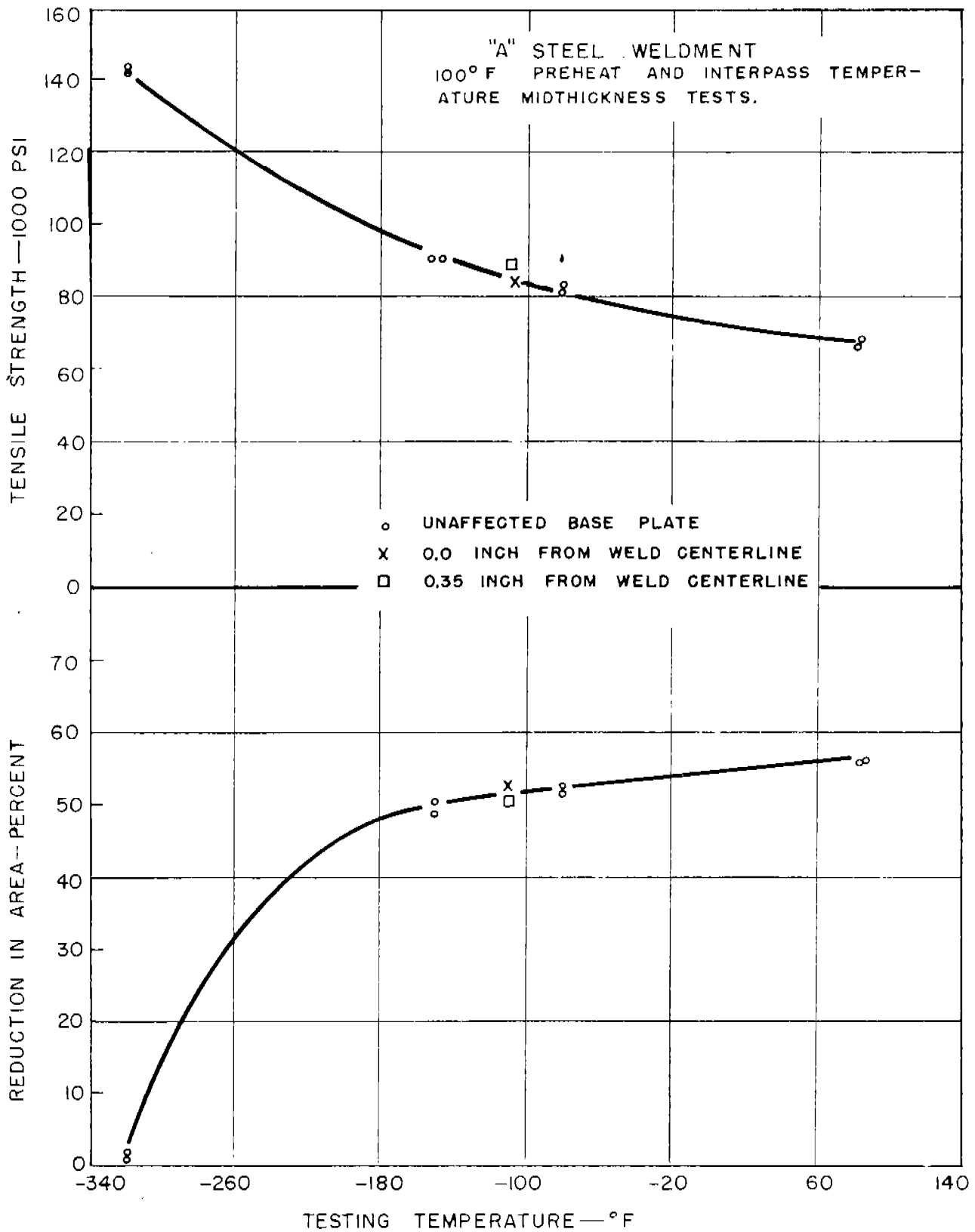

FIG. 16: REGULAR TENSILE PROPERTIES OF "A" STEEL AS A FUNCTION OF TESTING TEMPERATURE.

0.3 inch from the weld centerline. There seemed to be no difference in structure between that of the critical zone (0.3--0.4 inch from the weld centerline) and that of the parent plate when examined at either 100 or 2000 magnifications. The structures of the 0.3 inch position for the C steel which were pre and post-heated, respectively, also appeared to be the same as the unaffected base plate.

### Hardness Surveys

Rockwell B hardness distributions were first made at several levels of a C steel weldment with 100°F preheat, Fig. 17. The maximum hardness at the midthickness level ( $R_B 89$ ) occurred at the weld junction and was associated with a maximum ductility, whereas a lower hardness ( $R_B 83$ ) was found at the zone of minimum ductility.

To obtain the hardness distribution at more closely spaced intervals, microhardness tests were conducted across all the welds at the center of the plates, Fig. 18. A number of hardness peaks were found, the highest one being at the weld junction. The other peaks were due to the composite heat affected zone caused by the six weld passes. For the C steel weldments, the overall level of the distribution was decreased, in order, with increasing preheat and with postheat. The decrease in hardness in the zone of minimum ductility (0.3--0.4 inch from the weld centerline) appeared to correlate with the decrease in transition temperature in this zone brought about by the pre and postheat treatments.

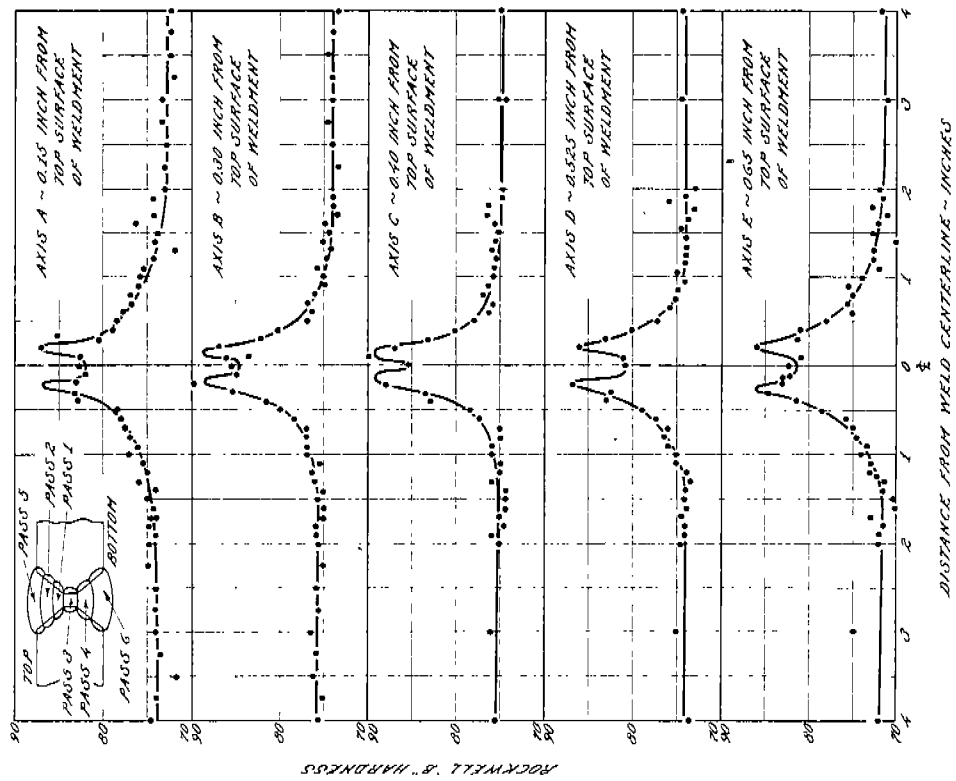

FIG. 7. DISTRIBUTION OF HARDNESS ACROSS WELD AT VARIOUS POSITIONS THROUGHOUT THE THICKNESS OF THE PLATE.

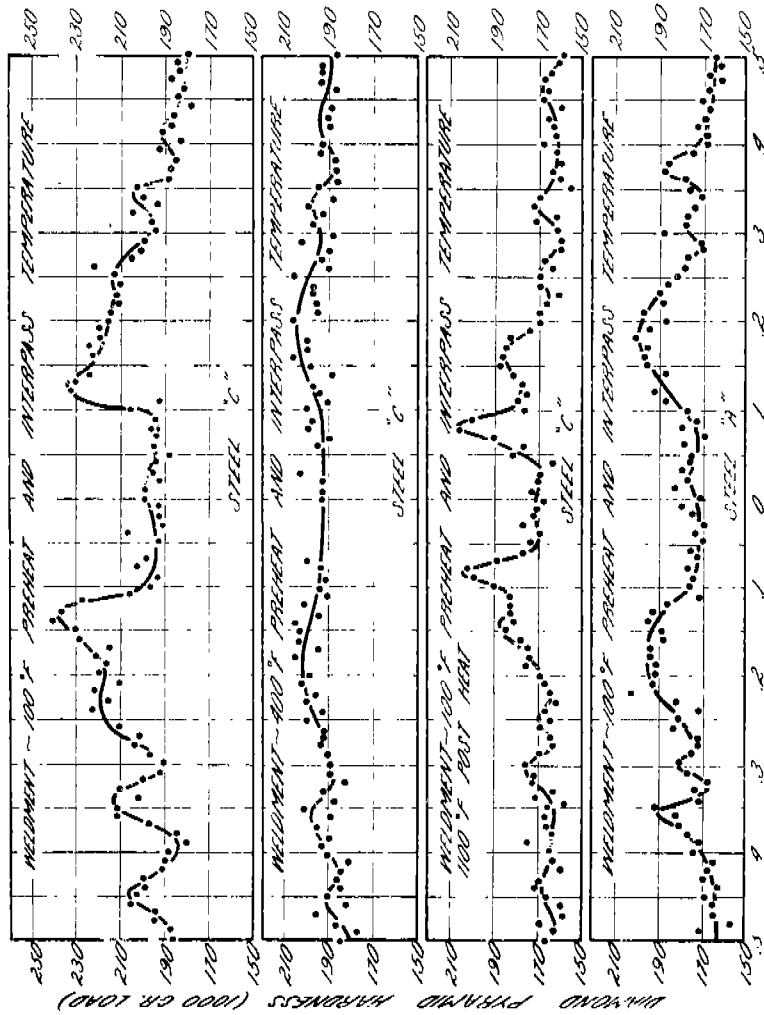

FIG. 18. DISTRIBUTION OF TEMPERATURES VALUES AT THE MIDTHICKNESS OF 1/2" PLATE WELDMENTS OF STEELS 2" AND 3".

The hardness curve for the A steel weldment was similar to that of the C steel with 100°F preheat, but the peaks were lower and the overall curve was lower.

#### Temperature Measurements

The results of the temperature measurements made during the welding of the C steel (at the midthickness level) are given in Figs. 19, 20, and 21. In Fig. 19, the maximum temperatures reached during the welding process are shown as a function of the distance from the weld centerline for the weldments with 100°F and 400°F preheat, respectively. In the region of low ductility (0.3--0.4 inch from the weld centerline) the temperature evidently never reached the lower critical temperature ( $Ac_1$ ) for either weldment.

In Fig. 20, the complete heating and cooling history is given for both welding conditions. A comparison of the heating and cooling cycles for the first pass for the two welding conditions, Fig. 21, showed that the 100°F preheat weldment had a faster cooling rate. This difference can be shown for all the weld passes.

#### Subcritical Heat Treatment (Preliminary Work)

An attempt was made to duplicate the embrittlement in the region of low ductility by means of subcritical heat treatment of base plate of C steel. Specimen blanks were cooled from 950°F to give three different cooling rates--air cool, oil quench, and water quench. The notch strengths determined at

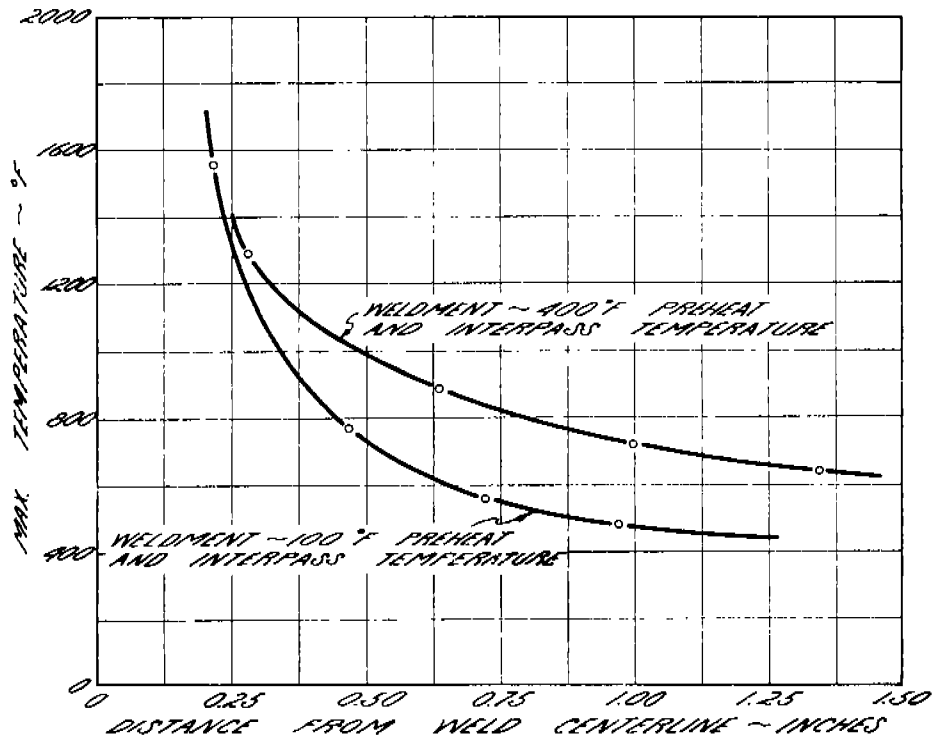

FIG. 19: MAXIMUM TEMPERATURES REACHED DURING WELDING FOR TWO WELDING CONDITIONS.

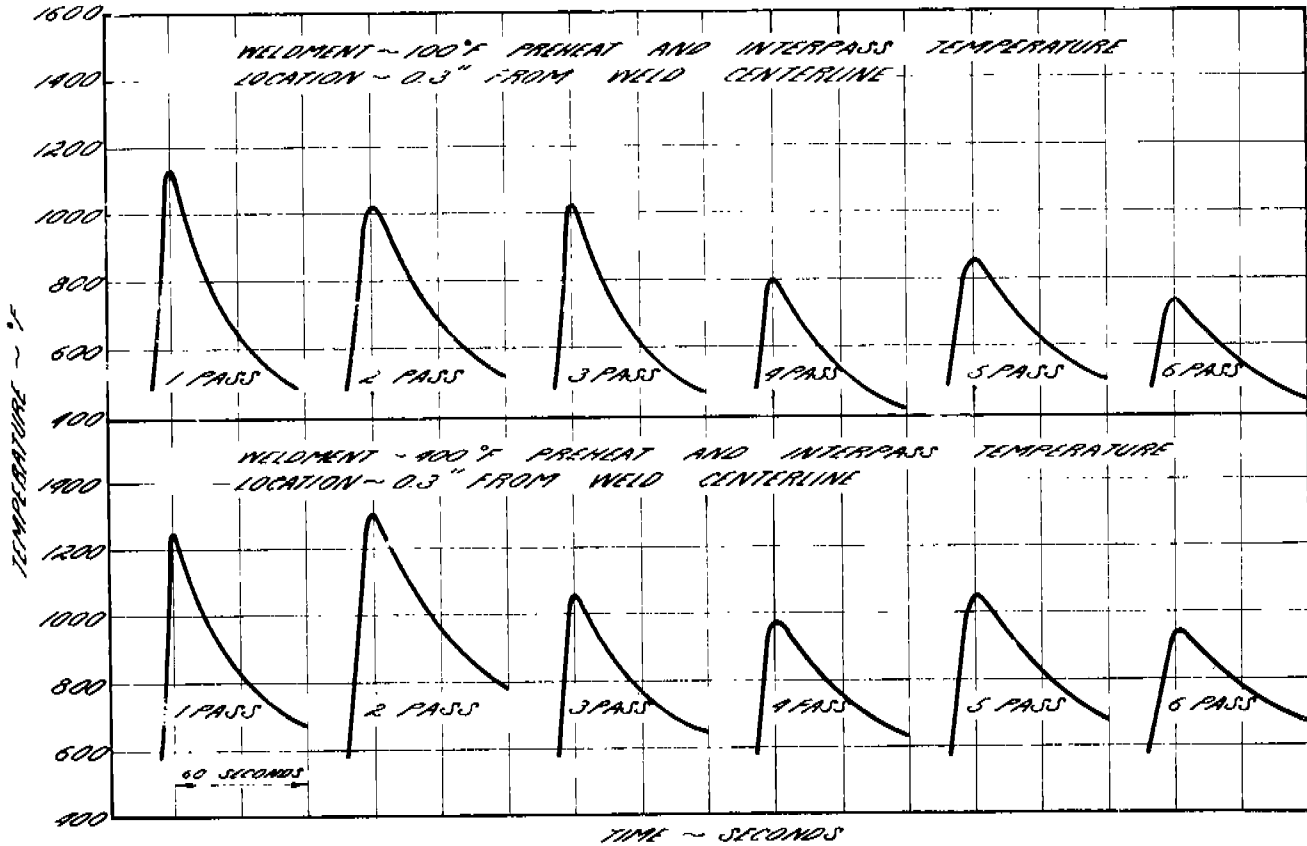

FIG. 20: HEATING AND COOLING CURVES IN THE REGION OF LOWEST DUCTILITY FOR TWO 6 PASS WELDMENTS.

-80°F for all three cooling rates were low, and when compared to the spread of values for the base plate at -80°F, Fig. 22, it was seen that the material was substantially embrittled by this heating and cooling.

PART II: THE EFFECT OF SUBCRITICAL HEAT TREATMENT ON THE TRANSITION TEMPERATURE OF A LOW CARBON SHIP PLATE STEEL.

The detection of a brittle zone in ship plate weldments in a region which was not heated above the lower critical temperature, and the preliminary work which showed that base plate could be embrittled by subcritical heating and cooling, led to an intensive study of the embrittlement of base plate by subcritical heat treatment. The effects of the following factors were studied: isothermal solution time and temperature, cooling rate, and aging time and temperature.

The embrittlement was evaluated by means of the eccentric notch tensile test, and also because it has such a wide degree of acceptance as a standard, by means of the Charpy V-notch test. This work was supplemented by hardness tests and microscopic examinations.

The studies were carried out with C steel because it was felt that its inferior 'as-received' properties portended a higher degree of embrittlement. The test specimens were prepared from the base plate as shown in Fig. A-7. Unless otherwise noted, all testing was done one month after heat

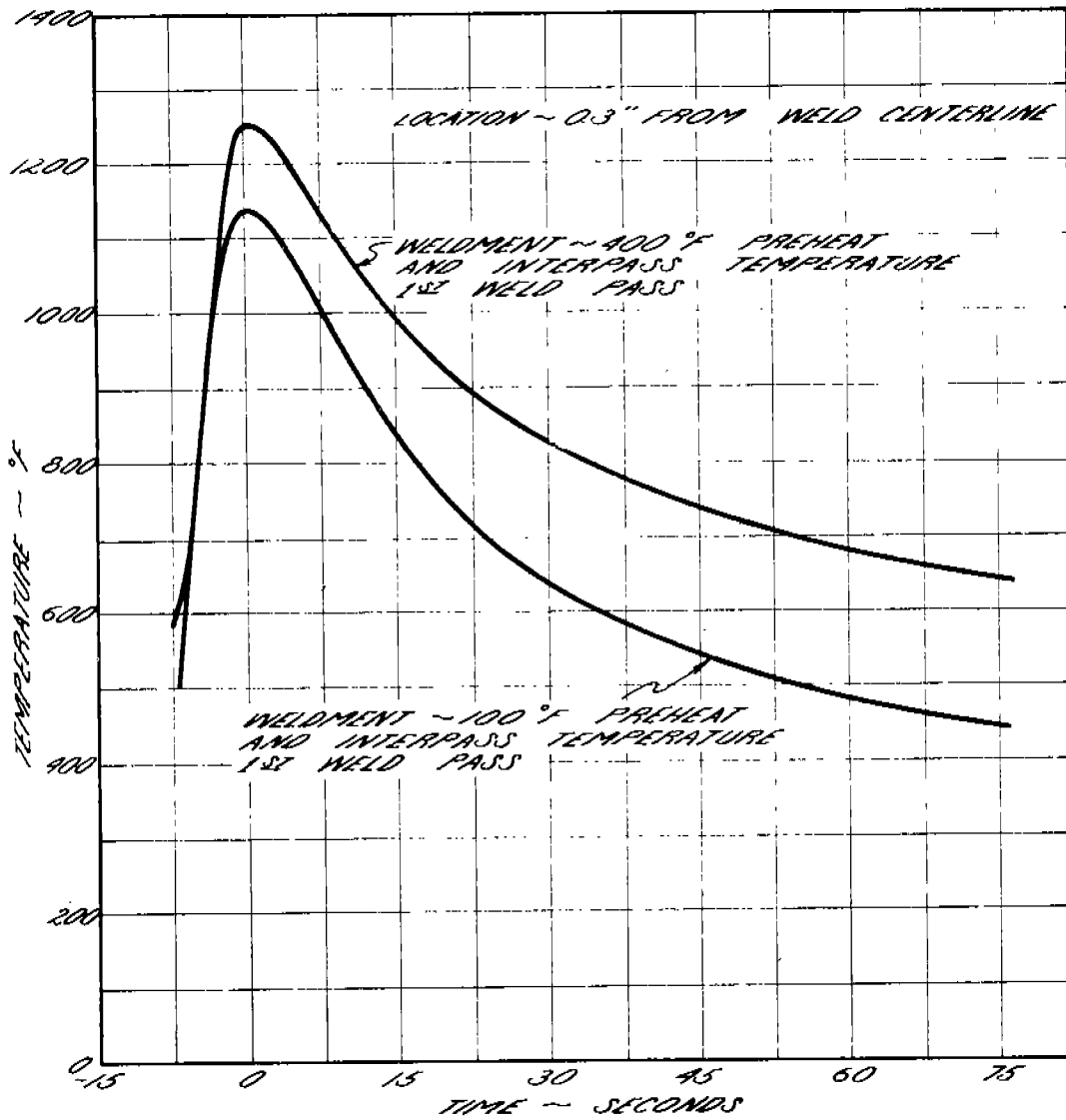

FIG. 21. HEATING AND COOLING CURVES IN THE REGION OF LOWEST DUCTILITY FOR TWO WELDING CONDITIONS.

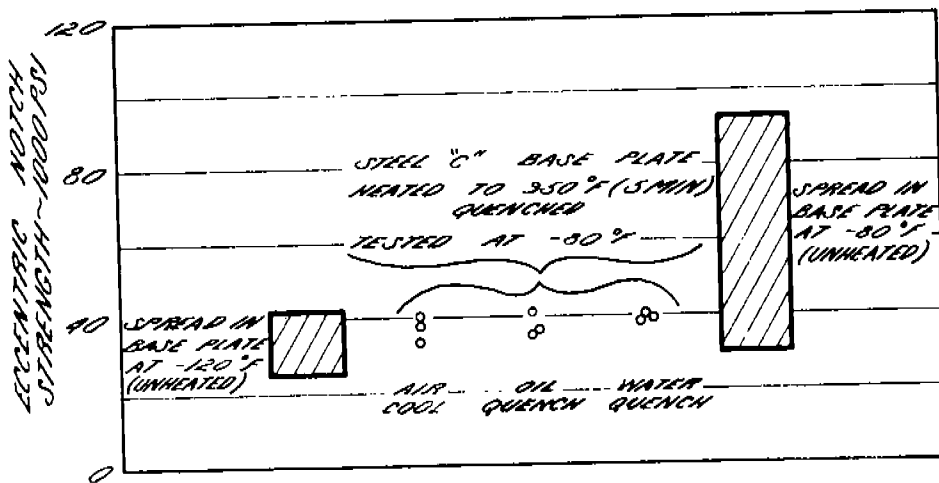

FIG. 22. EFFECT OF SUBCRITICAL HEATING AND COOLING ON THE ECCENTRIC NOTCH STRENGTH OF UNAFFECTED BASE PLATE.

treating in order to maintain approximately the same aging interval as used in the weldment study.

### Isothermal Studies

Prior to determining the effects of time and temperature, a check was made on the within-heat variation in transition properties of the two different large plates which supplied notch tensile specimens. The transition temperature of Plate I (-65°F) used in the earlier work on weldments was lower than that of Plate II (-40°F). Due to this appreciable difference, the results obtained with subcritically heat treated plate have been separated as to plate number\*.

### Air Cooled

The relationship between notch tensile transition temperature and time at various temperatures in the 700°--1200°F range is plotted in Fig. 23. With the properties of the as-received plate as a basis of comparison, the magnitude of the maximum embrittlement appeared to be independent of the temperature, amounting to a 10°F increase in transition temperature for Plate II and a 25°F increase for Plate I. Time at temperature had little effect, other than an improvement in properties at very long times due to a slightly spheroidized structure.

In Fig. 24, the transition temperature--isothermal time relationship for impact specimens heated at 1100° and 1200°F--

---

\*All impact specimens were obtained from Plate II.



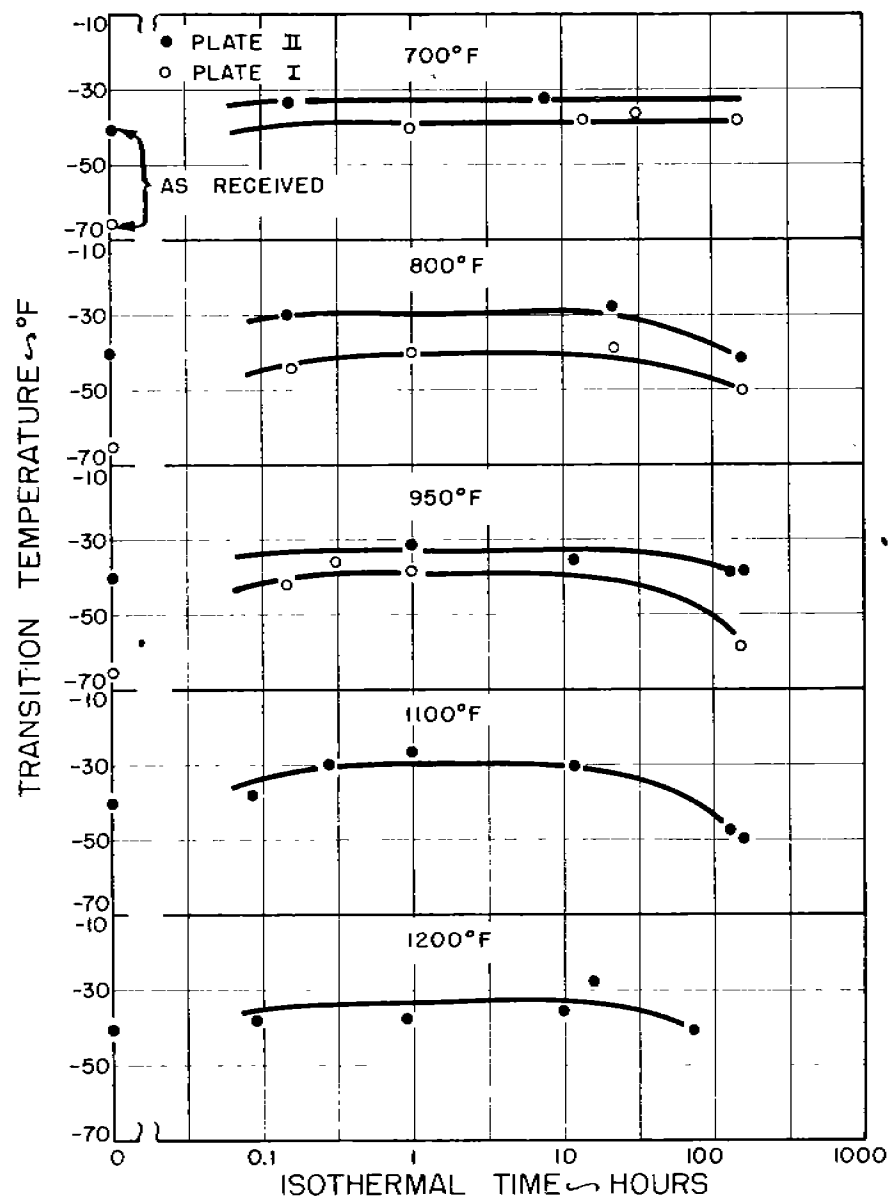

FIG. 23: ECCENTRIC NOTCH TENSILE TRANSITION TEMPERATURES OF "C" STEEL AS A FUNCTION OF TIME AT VARIOUS SUBCRITICAL TEMPERATURES. AIR COOLED.

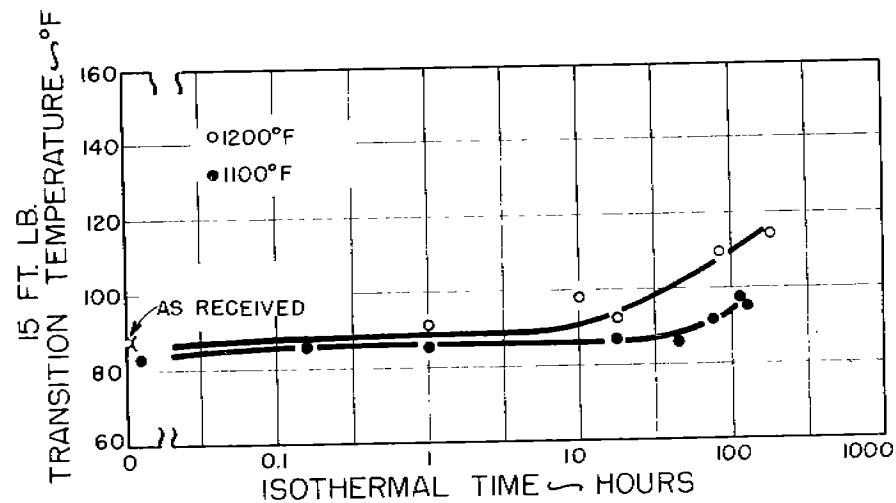

FIG. 24: CHARPY V-NOTCH TRANSITION TEMPERATURE AS A FUNCTION OF TIME AT SUBCRITICAL TEMPERATURES. AIR COOLED. PLATE II.

indicated no embrittlement at the shorter times; however, at the longer times a slowly increasing embrittlement\* , accompanied by a gradual softening.

#### Furnace Cooled

Spot checks with impact specimens indicated that no significant difference in transition properties can be expected from specimens comparably heat treated and air cooled. Although no checks were made with notch tensile specimens, it is believed that a furnace cool would result in no embrittlement because the cooling rate would be less than the critical necessary to introduce quench-aging effects.

#### Water Quenched

The transition temperature-time curves for notch tensile specimens quenched from 1100°F and 1200°F and aged one month at room temperature, Fig. 25, were displaced to much higher transition temperature than the comparable air cooled curves, indicating a severe embrittlement, and with the magnitude of the embrittlement amounted to about a 50°F increase in transition temperature above that of the as-received plate; and for the 1200°F series, an average of about 100°F increase in transition temperature.

With impact specimens, Fig. 25, the transition temperature-

---

\*It should be recalled that although embrittlement was indicated by three different criteria, the upper level of "energy absorbed" was raised, indicating an improvement in properties at the higher testing temperatures.

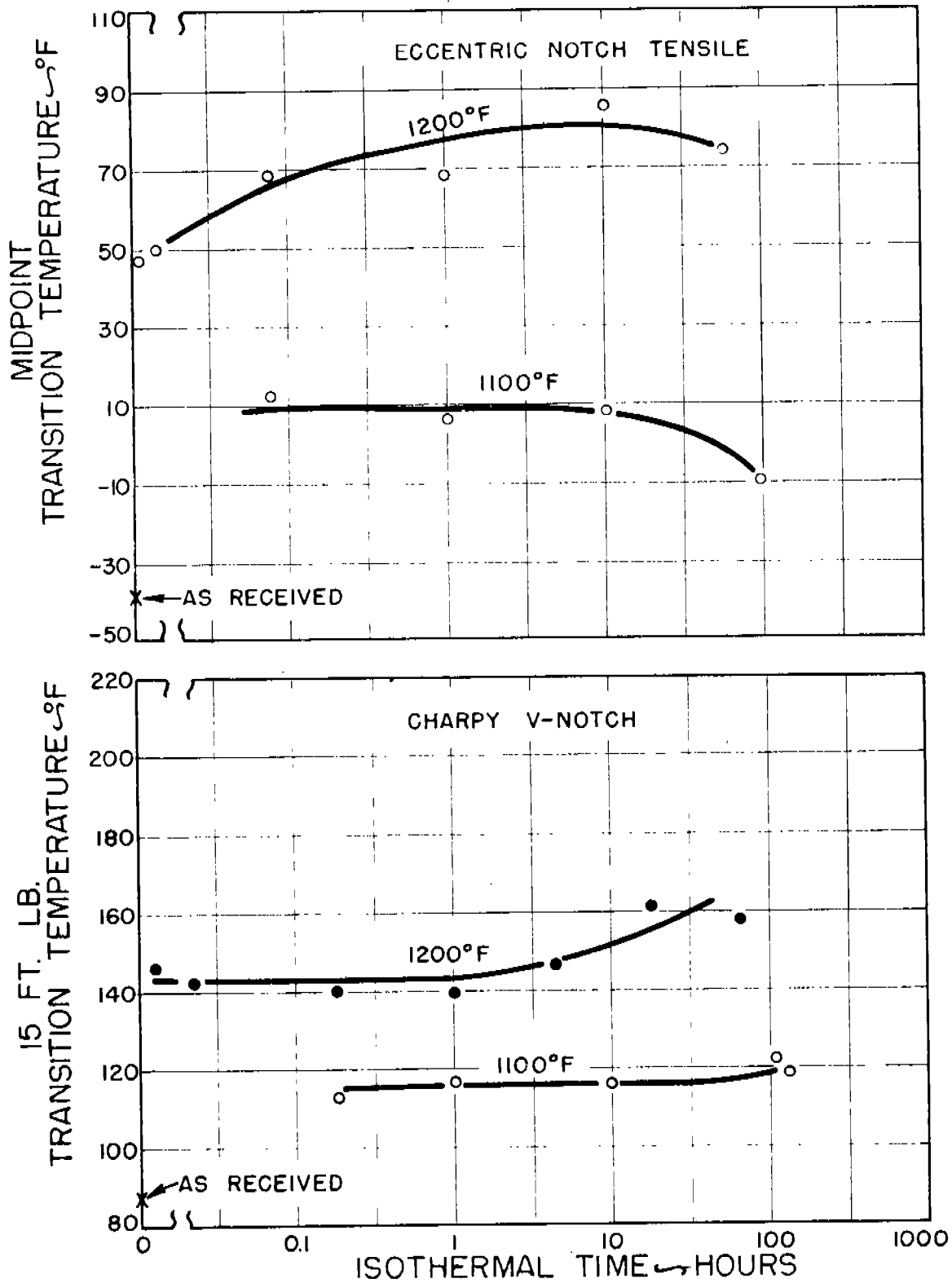

FIG. 25: TRANSITION TEMPERATURES OF "C" STEEL AS A FUNCTION OF TIME AT SUBCRITICAL TEMPERATURES. WATER QUENCHED AND AGED ONE MONTH AT ROOM TEMPERATURE. PLATE II.

time curve for the 1100°F treated series was displaced about 25°F and the 1200°F series about 55°F above their respective air cooled curves.

#### Effect of Heating Medium

In the first stages of this investigation, both air and a nitrate salt bath were used as the heating medium. It was noticed that, generally, test specimens heated in salt had higher transition temperatures and hardnesses than specimens similarly treated in air. This anomalous behavior was revealed in both the Charpy V-notch and eccentric notch tensile data.

Both the impact and notch tensile transition temperatures revealed that the magnitude of embrittlement accompanying an air cool from the salt heat treatments was increased with temperature, and time at temperature, as evident in the comparison with the results obtained after heat treating in air, Fig. 26. The impact data also revealed that the embrittlement increased with an increase in cooling rate, Fig. 27.

Metallographic examination, chemical analyses, and X-rays showed the embrittling agent to be nitrogen, introduced by diffusion into the specimens through a scaling reaction of the metal with the salt.

#### Quench-Aging Studies

In order to determine the room temperature aging effects, impact specimens were tested after various aging times after water quenching from 1200°F and 1300°F. Both the transition

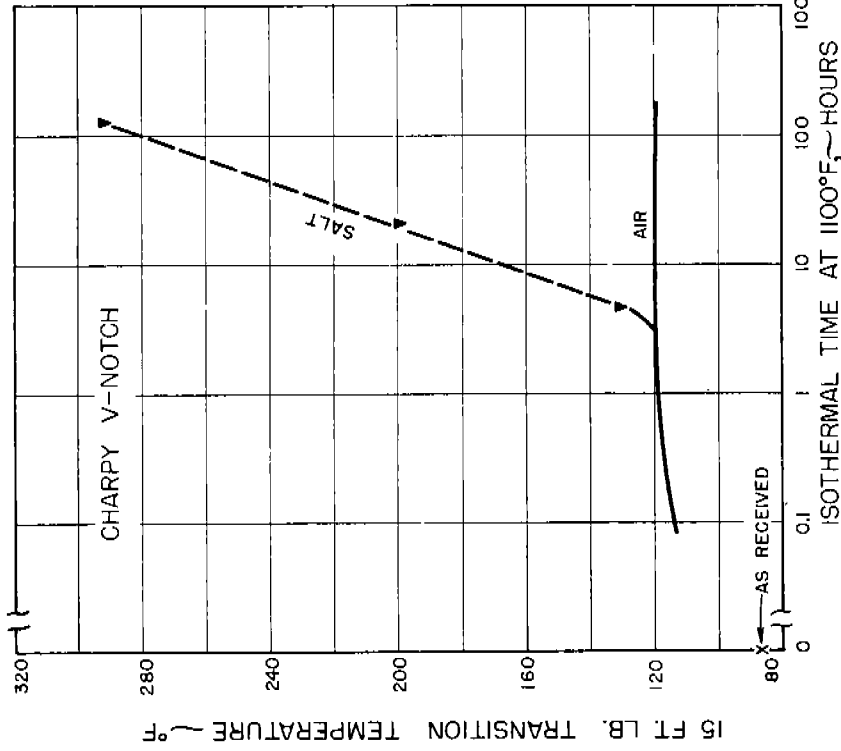

FIG. 27: TRANSITION TEMPERATURES OF "C" STEEL RESULTING FROM HEATING AT 1100°F FOR VARIOUS TIMES IN NITRATE SALT BATH AND IN AIR, EMPLOYING A WATER QUENCH. AGED ONE MONTH AT ROOM TEMPERATURE.

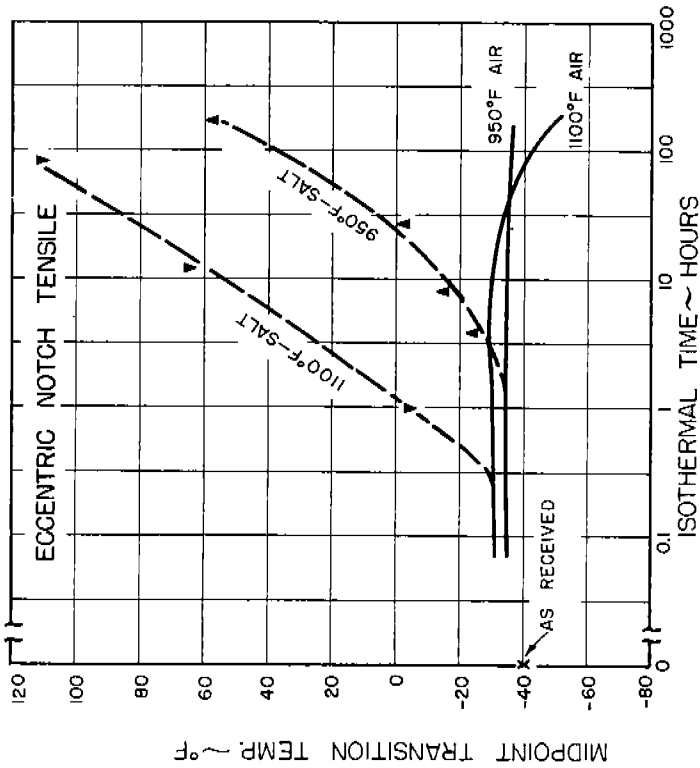
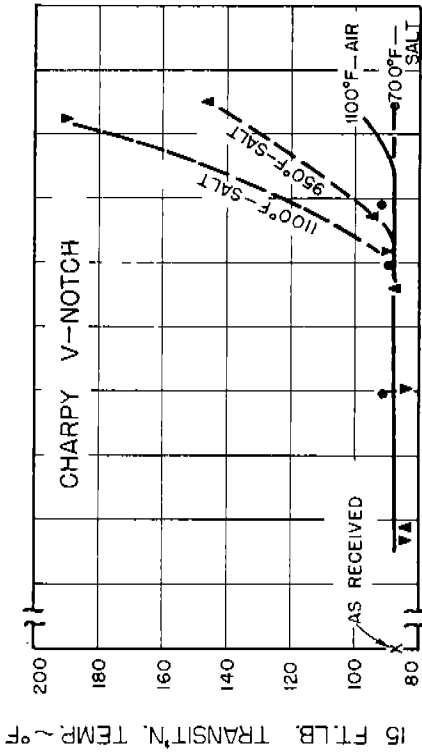

FIG. 26: TRANSITION TEMPERATURES OF "C" STEEL RESULTING FROM VARIOUS SUBCRITICAL HEAT TREATMENTS IN NITRATE SALT BATH AND IN AIR, EMPLOYING AN AIR COOL.

temperature and hardness increased with increasing solution temperature and with increasing aging time, reaching a maximum level, Fig. 28.

To determine the maximum embrittlement due to quench-aging, and how to minimize it, hardness tests were first made after water quenching from 1300°F and aging for various periods of time in the 35° to 1100°F range, Fig. 29. The peak hardness reached and the time to attain this peak decreased with increasing aging temperature. Similar changes were observed with the impact transition temperature, Fig. 30, when employing aging temperatures from room temperature to 600°F.

To obtain a quantitative measure of the solid solution and aging effects as a function of solution temperature from room temperature to 1300°F, Fig. 31 was prepared. Below solution temperatures of 650°F, the quench-aging effects were absent, but then increased with increasing solution temperature. The maximum embrittlement induced in C steel by the quench-aging mechanism amounted to a 90°F increase in impact transition temperature and 25 points increase in Rockwell B hardness.

### Microstructures

To afford a possible explanation of the embrittlement obtained during subcritical heat treatment, numerous structures were examined at 2000X. All specimens which were air or furnace cooled showed no difference in structure from that of the as-received plate except a slight spheroidization which set in at

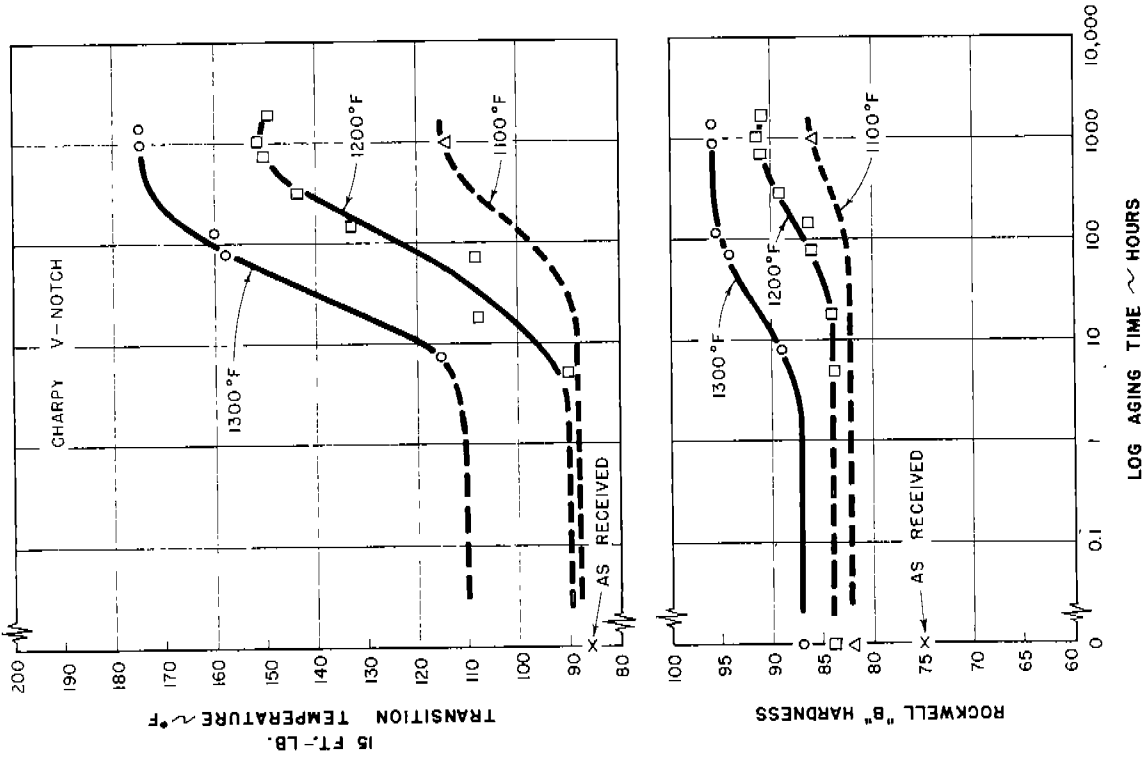

FIG. 28: EFFECT OF ROOM TEMPERATURE AGING TIME ON THE TRANSITION TEMPERATURE AND HARDNESS OF "C" STEEL AFTER WATER QUENCHING FROM TEMPERATURES INDICATED.

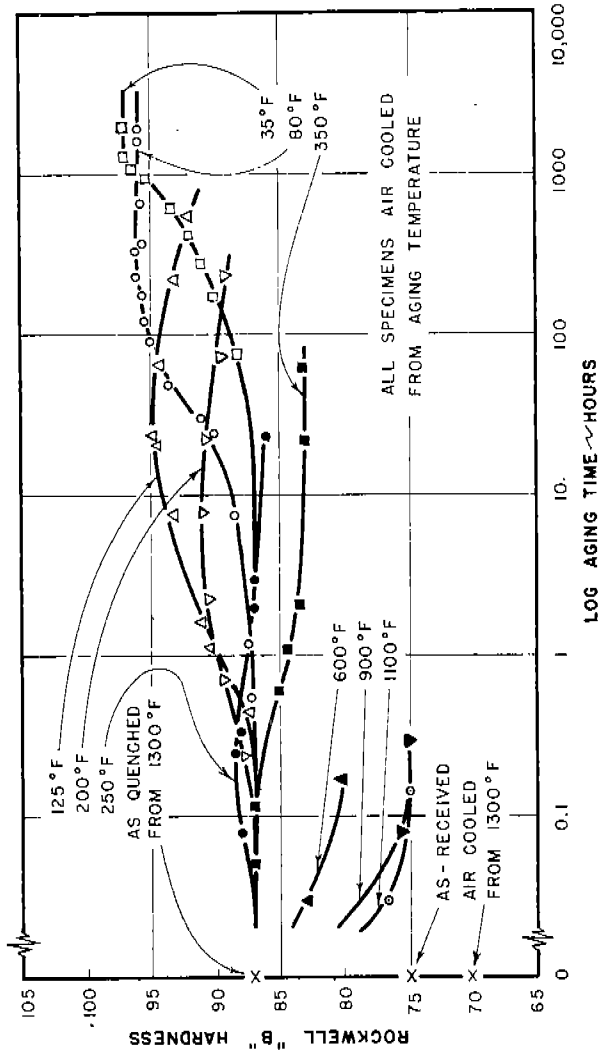

FIG. 29: EFFECT OF VARIOUS AGING TIMES AND TEMPERATURES ON THE HARDNESS OF "C" STEEL AFTER WATER QUENCHING FROM 1300°F.

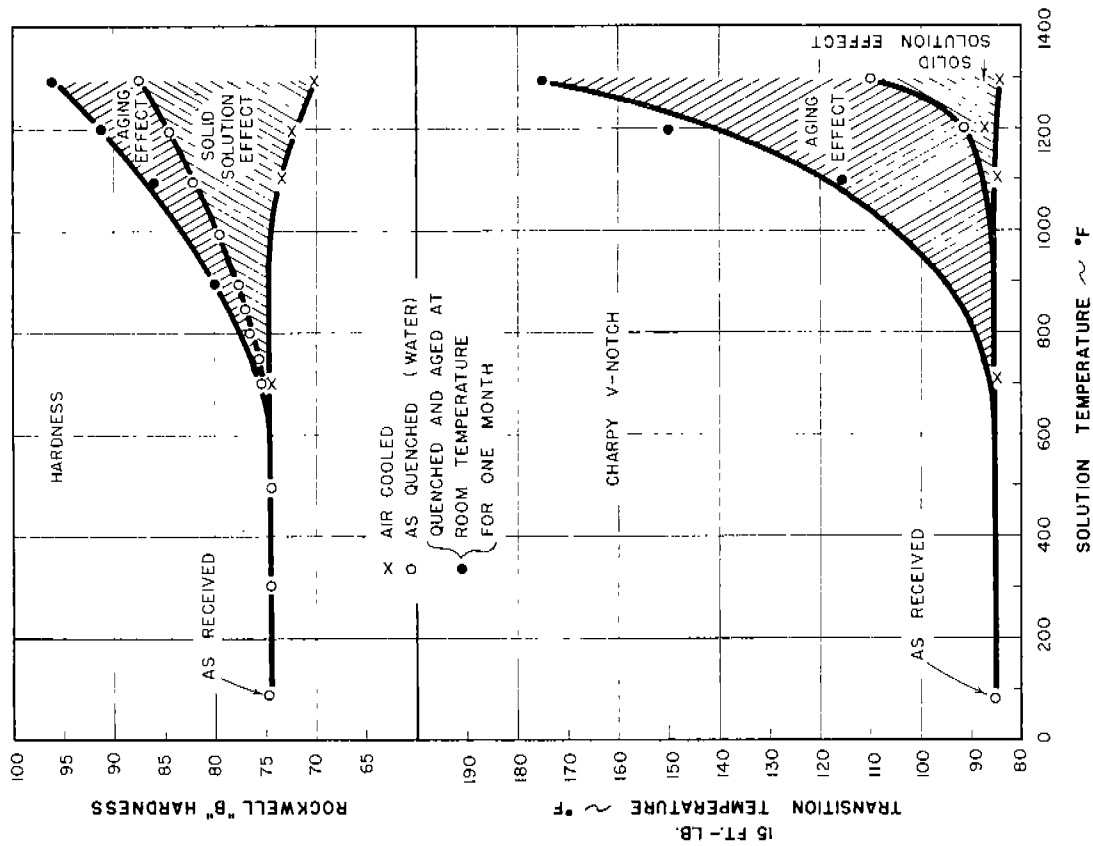

FIG. 31: SOLUTION AND ROOM TEMPERATURE AGING EFFECTS ON THE HARDNESS AND IMPACT PROPERTIES OF "C" STEEL.

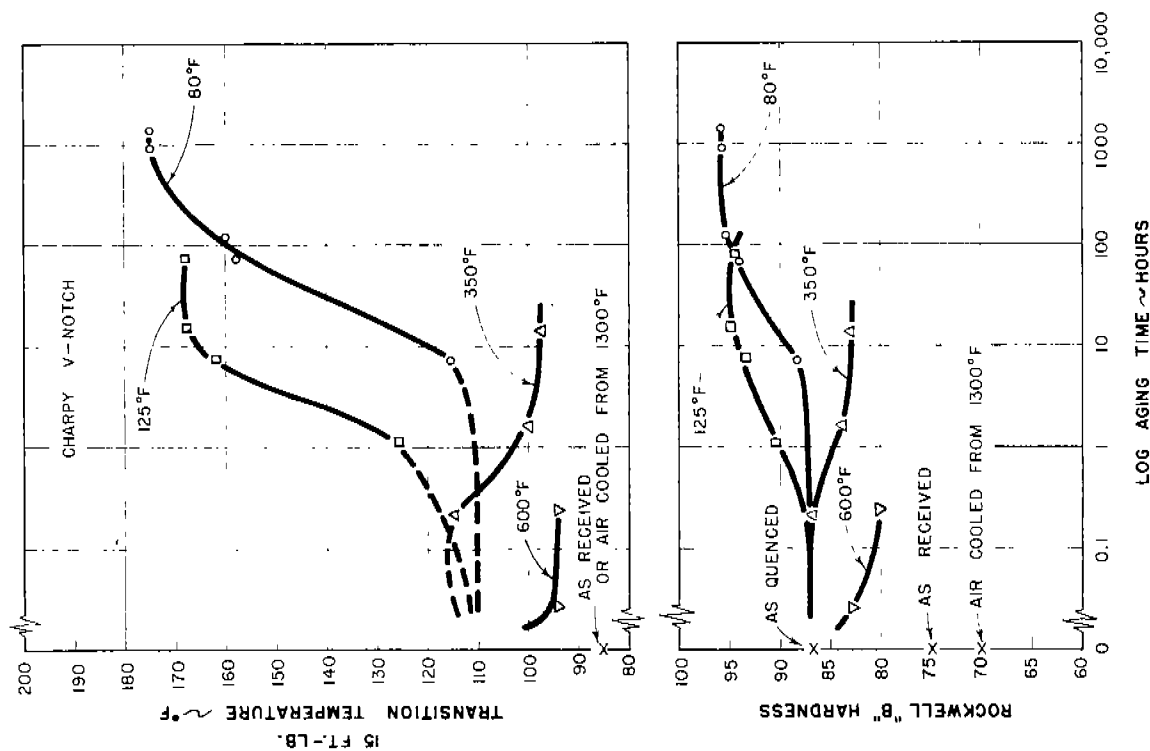

FIG. 30: SUMMARY CURVES SHOWING EFFECT OF VARIOUS AGING TEMPERATURES AND TIMES ON THE TRANSITION TEMPERATURE AND HARDNESS OF "C" STEEL. SPECIMENS WATER QUENCHED FROM 1300°F BEFORE AGING.



the longer times at the higher temperatures. No difference in microstructure from that of the base plate was detected in the series water quenched from either 1100° or 1200°F and aged at room temperature, again with the exception of spheroidization setting in at the longer times. The first indication that a precipitation reaction was operative was obtained in a series aged at 400°F after water quenching from 1200°F, which showed a general precipitation throughout the ferrite grains.

A study of the structures after quenching from 1300°F and aging at various temperatures for various times, indicated that the precipitation from the supersaturated solution was a two-stage process. At low aging temperatures the precipitate was detected as a mottling of the ferrite grains; at the higher aging temperatures, where an 'overaged' condition was rapidly reached, the precipitate had grown so as to be resolvable.

#### Cooling Rates

The results of the temperature measurements made during the cooling of subcritically heated test specimens from 1200°F are shown in Fig. 32, in comparison with the cooling curves associated with the zone of minimum ductility for the first weld pass for the two welding conditions. With an air cool the impact specimens cooled at a slightly slower rate than the notch tensile specimens due to the larger mass of metal, but at a rate which was still slower than that obtained in the 400°F preheat weldment. Although the 100°F preheat weldment had a faster cooling rate than the 400°F preheat weldment, the cooling rate for

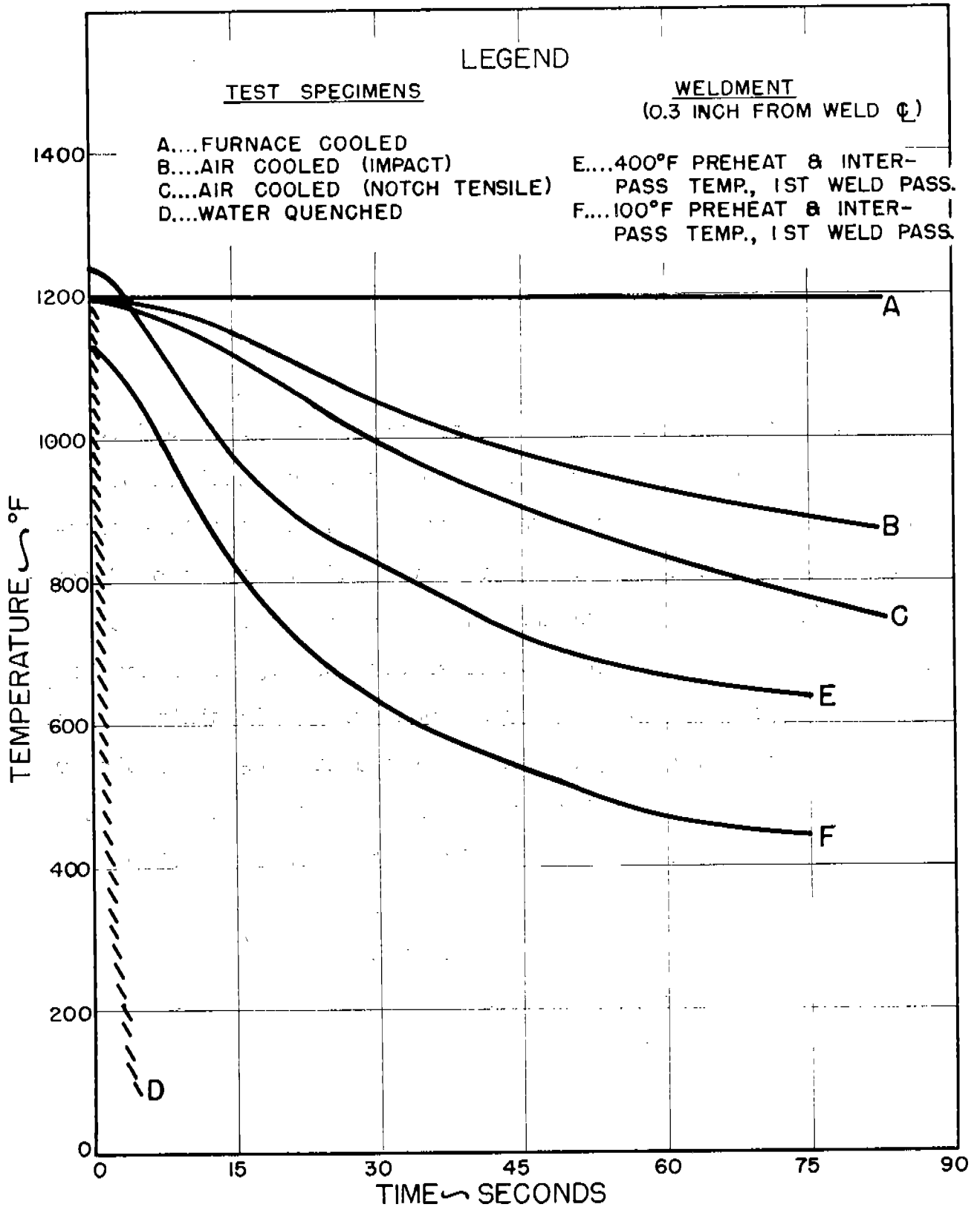

FIG. 32: COMPARISON OF COOLING CURVES IN THE REGION OF LOWEST DUCTILITY FOR TWO WELDING CONDITIONS WITH THOSE OBTAINED WITH HEAT TREATED TEST SPECIMENS.

both these welding conditions were intermediate to the air cooled and water quenched test specimens.

#### INTERPRETATION OF RESULTS

In the weldment study the variations in ductility across the weld area were represented by the distribution of notch tensile transition temperature, Fig. 8. It was believed that the maximum ductility observed near the weld junction was associated with a tempered martensitic structure, whose ductility was higher than that of pearlite.

The location of the ductility minimum corresponded to a region which was not heated above the lower critical temperature, which, coupled with a relatively fast cool, pointed to embrittlement by the subcritical precipitation of carbide from ferrite (quench-aging). That this mechanism was operative appeared to be corroborated by the beneficial effects of higher preheat and of postheat treatment. The improvement of the ductility in this critical region with higher preheat was attributed to a slower cool, allowing less solid solution and subsequent aging postheat effects, while the virtual elimination of embrittlement by postheat was believed due to 'overaging'.

Due to a difference in the general types of microstructure across the weld area, the hardness could not be used as a measure of ductility. The peak in hardness was associated with the maximum notch strength at the weld junction, but the minimum in notch strength occurred in a subcritically heated region, where

the hardness was leveling off. However, considering the critical region which had the same general type of microstructure, the hardness appeared to be correlated with the ductility, i.e., a higher hardness signified a higher transition temperature.

From the complexity of the time, temperature, cooling rate conditions in a multi-pass weldment, it was impossible to determine the exact quench-aging cycle experienced in the critical region. It was believed that each weld pass contributed to the solid solution and aging effects, but that the first few weld passes controlled the amount of carbon initially retained in solution, while the following passes served mainly as short accelerated aging treatments.

In the subcritical work, the investigation of the effects of solution time and temperature, cooling rate, and aging time and temperature revealed significant changes in ductility, hardness, and microstructure. These changes were largely reconciled with the quench-aging mechanism.

The isothermal studies showed that no appreciable variation in ductility can be expected by varying the time at temperature with the exception that at long times at the higher subcritical temperatures softening set in due to slight spheroidization. This stability with time indicated that the critical region in weldments was not the result of decay of an unstable condition.

Air cooling or furnace cooling from subcritical temperatures resulted in little or no embrittlement. The slight

embrittlement that was obtained by air cooling notch tensile specimens was about the same as that found in the critical region of the C steel weldment made with 400°F preheat, and as was shown in Fig. 32, the cooling rates were about the same. With an air or furnace cool, it was reasoned that the degree of supersaturation was low or nil due to the fact that precipitation occurred largely during cooling; consequently, no appreciable change in ductility was realized on subsequent aging.

A consideration of the quench-aging results showed that the degree of embrittlement was influenced by the subcritical temperature and the aging time and temperature. The solubility of carbon in ferrite increased with increasing solution temperature, resulting in a greater 'as-quenched' hardness, and, apparently, a greater initial transition temperature due to the higher degree of supersaturation. Upon subsequent room temperature aging, the magnitude of the peak embrittlement reached also increased, the higher was the solution temperature, Fig. 28. This was in line with other quench-aging systems which showed that a greater change in properties can be expected with increasing solution temperature.

With accelerated aging, the changes in transition temperature and hardness, Figs. 29 and 30, revealed characteristic aging curves, i.e., the maximum embrittlement attained and the time to reach this maximum decreased with increasing aging temperature.

From the metallographic changes that occurred during aging, it appeared that a two-stage precipitation reaction was operative. The first stage (evident as a mottling of the ferrite) was responsible for the greater degree of embrittlement, while the second stage in which a resolvable precipitate was detected, was associated with an improvement in properties corresponding to a rapid 'overaged' condition. No attempt at identification of the precipitate was made; however, the sequence of changes appeared to be the same as reported in a recent paper (8). The first stage was identified as the hexagonal  $\epsilon$ -iron carbide, while the second stage overlapped the first and was associated with a change in the crystal lattice to cementite (orthorhombic  $\text{Fe}_3\text{C}$ ).

Insofar as microstructural changes were concerned, the brittle zone found in the subcritically heated region in weldments was not identified with a precipitation reaction. It was speculated that because the cooling rate in this region was such that the ferrite was not supersaturated to the maximum possible as in water quenched test specimens, less carbon was available for the subsequent aging reaction and the resulting small amount of precipitation was not detected.

In regard to the changes in transition temperature and hardness, the results of the subcritical work gave the maximum embrittlement possible by quench-aging. Any treatment designed to remove these effects in base plate should be applicable to the subcritically embrittled region of weldments. 'Overaging' or postheating treatments at about 650°F would minimize the embrittlement. Higher temperatures would progressively lead to still greater

improvement if a slow cool were employed; however, another quench-aging cycle could be initiated upon fast cooling from above 650°F.

APPENDIX A



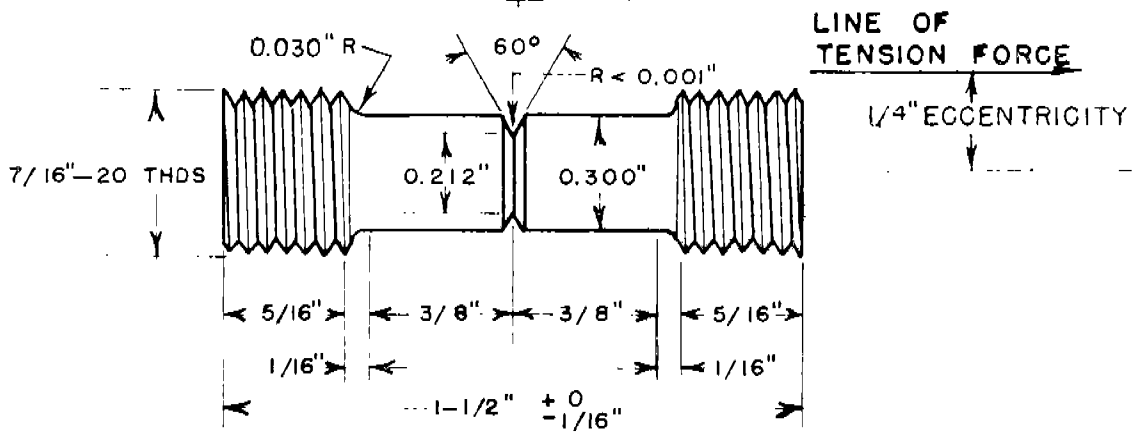

ECCENTRIC NOTCH TENSILE SPECIMEN

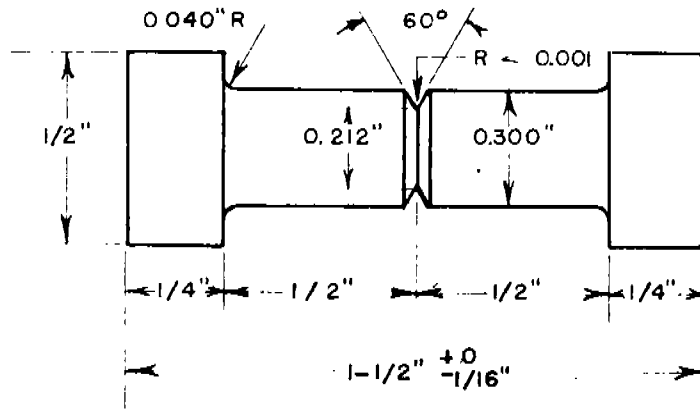

CONCENTRIC NOTCH TENSILE SPECIMEN

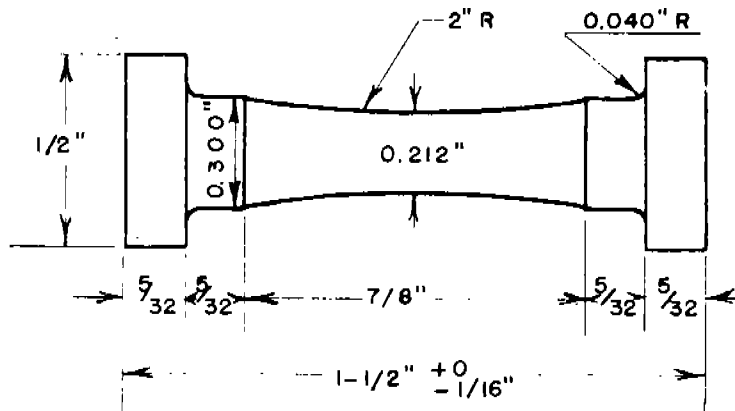

UNNOTCHED TENSILE SPECIMEN

FIG. A1: TEST SPECIMENS

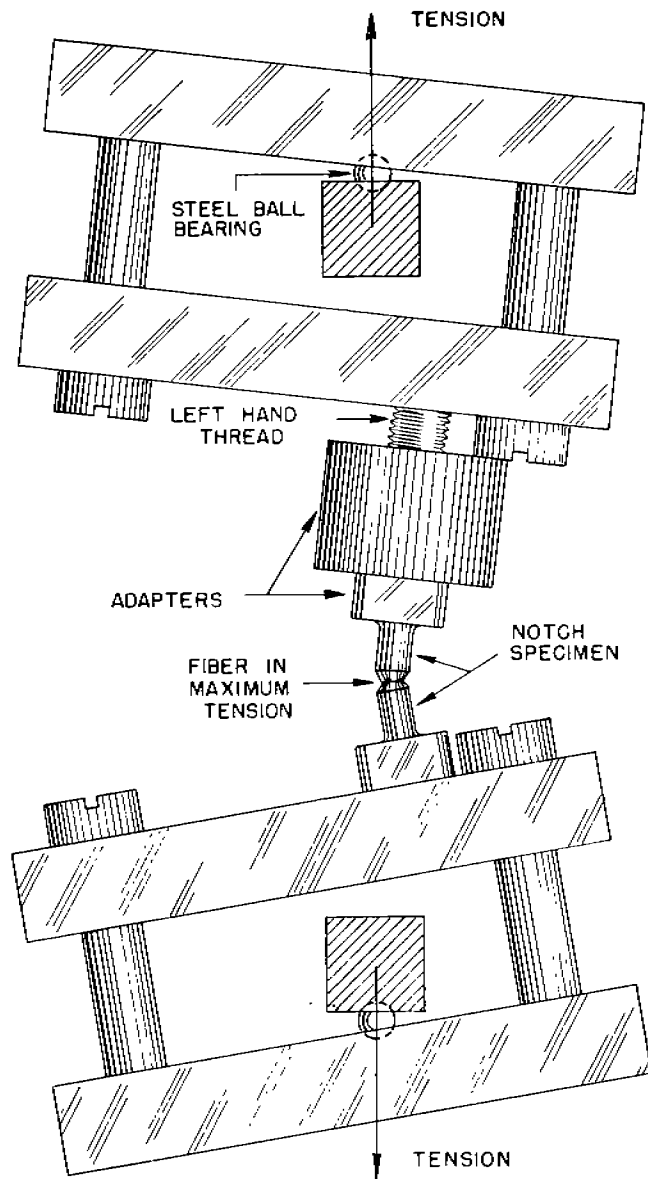
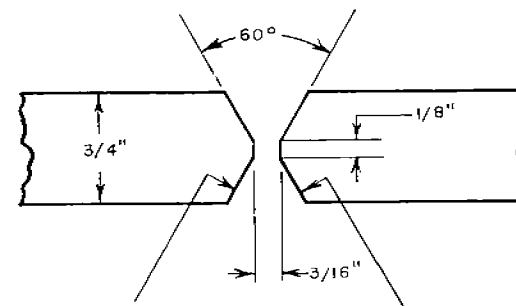
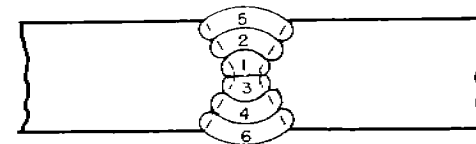

FIG. A2: METHOD OF LOADING TO OBTAIN 1/4 INCH ECCENTRICITY. (ECCENTRICITY AND THE POSITION OF FIXTURES ARE EXAGGERATED.)



EDGES MACHINE — BEVELED

FIG. A3: PLATE PREPARATION



ELECTRODE — 3/16" E6010  
 PASSES 1, 3, 5, 6: SAME DIRECTION  
 PASSES 2, 4: OPPOSITE DIRECTION

FIG. A4 : WELDING PROCEDURE

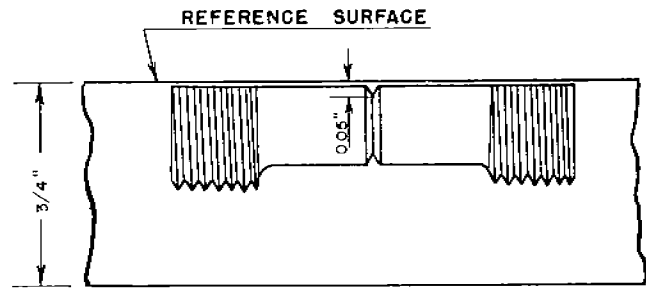

FIG. A5 : LOCATION OF ECCENTRIC NOTCH SPECIMEN AT THE SURFACE LEVEL

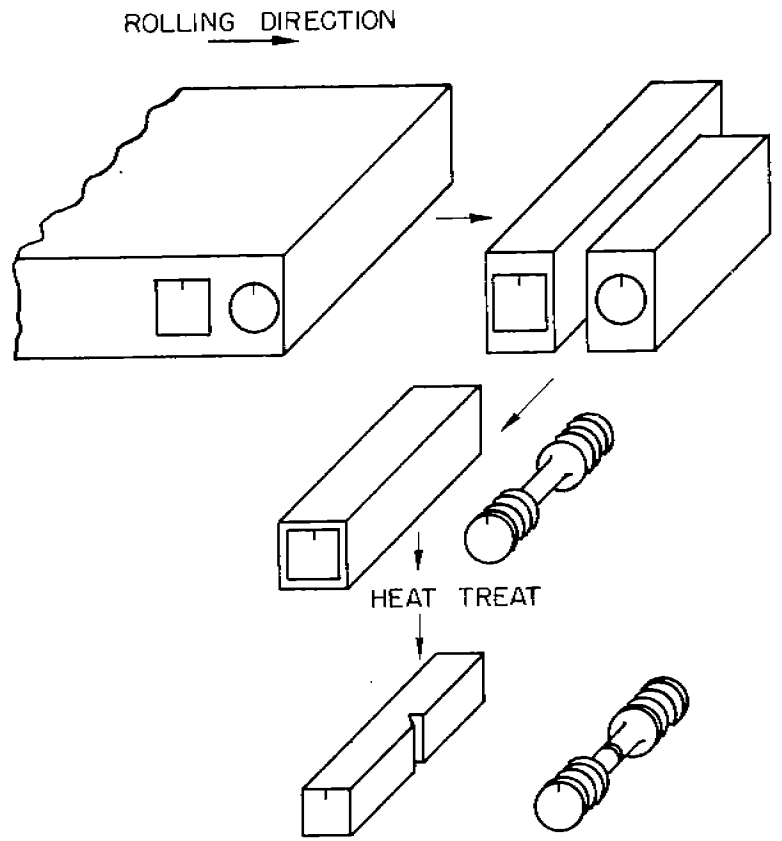

FIG. A7 : PREPARATION OF CHARPY V-NOTCH AND NOTCH TENSILE SPECIMENS FROM "C" STEEL PLATE.

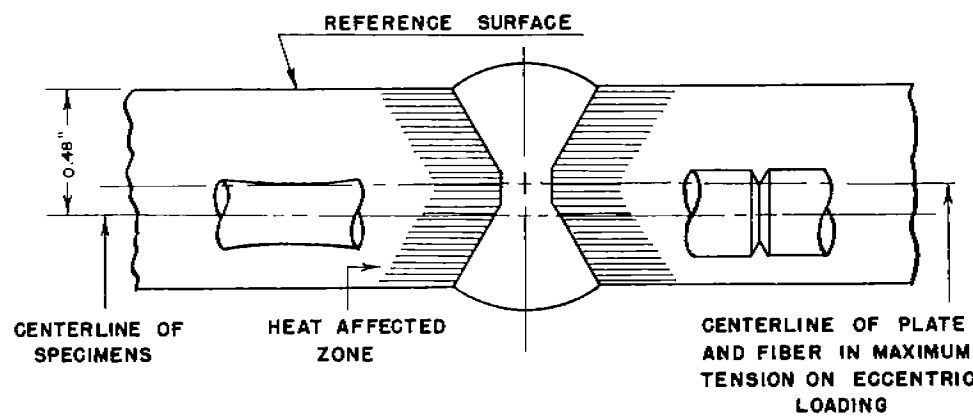

FIG. A6 : LOCATION OF UNNOTCHED AND NOTCHED SPECIMENS AT THE MIDTHICKNESS OF WELDMENT

APPENDIX B

TABLE B-1

Properties of A and C Steel Plate\*

Chemical Composition %

	<u>C</u>	<u>Mn</u>	<u>P</u>	<u>S</u>	<u>Si</u>	<u>Al</u>	<u>Ni</u>
C Steel	0.24	0.48	0.012	0.026	0.05	0.016	0.02
A Steel	0.26	0.50	0.012	0.039	0.03	0.012	0.02

	<u>Cu</u>	<u>Cr</u>	<u>Mo</u>	<u>Sn</u>	<u>N</u>	<u>V</u>	<u>As</u>
C Steel	0.03	0.03	0.005	0.003	0.009	0.02	0.01
A Steel	0.03	0.03	0.006	0.003	0.004	0.02	0.01

Mechanical Properties

	<u>Yield Point</u> <u>Psi</u>	<u>Tensile Strength</u> <u>Psi</u>	<u>Elongation</u> <u>Per Cent</u>
C Steel	39,000	67,400	25.5 (8" gage)
A Steel	37,950	59,910	33.5 (2" gage)

Note: Both steels were semi-killed, 3/4" plate in the as-rolled condition.

\*Technical Progress Report of the Ship Structure Committee, Welding Journal, Vol. 13 (July, 1948), p. 377s-384s.

TABLE B-2

Welding Data

Harnischfeger - D. C. Welder

	Electrode: 3/16 E6010	Reversed Polarity
Current	150 amps	Pass 1
	160 amps	Passes 2-6
Voltage	25 volts	Passes 1-6
Welding Speed	3.6 in/min.	Pass 1
	4.8 in/min.	Passes 2-6
Electrode Burn Off Rate	8.5 in/min.	Passes 1-6

Note: All welding was manual.

BIBLIOGRAPHY

1. "The Fundamental Factors Influencing the Behavior of Welded Structures under Conditions of Multiaxial Stress, and Variations of Temperature, Stress Concentration, and Rates of Strain", by G. Sachs, L. J. Ebert, and A. W. Dana, First Progress Report, Ship Structure Committee, Serial Number SSC-24, 10 May 1949.
2. "The Fundamental Factors Influencing the Behavior of Welded Structures under Conditions of Multiaxial Stress, and Variations of Temperature, Stress Concentration, and Rates of Strain", by L. J. Klingler, L. J. Ebert and W. M. Baldwin, Jr., Second Progress Report, Ship Structure Committee, Serial Number SSC-34, 28 November 1949.
3. "The Fundamental Factors Influencing the Behavior of Welded Structures under Conditions of Multiaxial Stress, and Variations of Temperature", by E. B. Evans and L. J. Klingler, Third Progress Report, Ship Structure Committee, Serial Number SSC-54, 14 October 1952.
4. "The Effect of Subcritical Heat Treatment on the Transition Temperature of a Low Carbon Ship Plate Steel", by E. B. Evans and L. J. Klingler, Fourth Progress Report, Ship Structure Committee, Serial Number SSC-60, 30 October 1953.
5. "The Effect of Subcritical Heat Treatment on the Transition Temperature of a Low Carbon Ship Plate Steel", by E. B. Evans and D. J. Garibotti, Fourth Progress Report, Ship Structure Committee, Serial Number SSC-61, 30 October 1953.
6. "Comparison of Various Structural Alloy Steels by Means of the Static Notch-Bar Tensile Test", by G. Sachs, L. J. Ebert, and W. F. Brown, Jr., Trans. Am. Inst. Mining and Met. Engrs., Vol. 171 (1947), p. 605-621.
7. "Notched Bar Tensile Test Characteristics of Heat Treated Low Alloy Steels", by G. Sachs, J. D. Lubahn, and L. J. Ebert, Trans. Am. Soc. for Metals, Vol. 33 (1944), p. 340-395.
8. "The Quench-Aging of Iron", by Anna L. Tson, J. Nutting, and J. W. Menter, Journal of the Iron and Steel Institute, Vol. 172, Part 2, October 1952, pp. 163-171.