



THE SOCIETY OF NAVAL ARCHITECTS AND MARINE ENGINEERS  
601 Pavonia Avenue, Suite 400, Jersey City, New Jersey 07306 USA

Presented at the Marine Structural Inspection, Maintenance, and Monitoring Symposium  
Sheraton National Hotel, Arlington, Virginia, March 18-19, 1991

## The Structural Renovation of a Liquefied Gas Carrier

G.L. Stiehl, West Coast Shipping Company, Los Angeles, California

M.C. Cheung, MCA Engineers, Newport Beach, California

G.G. Kojayan, West Coast Shipping Company, Los Angeles, California

### ACKNOWLEDGMENTS

The structural renovation of the S/S CORNUCOPIA has been a very prolonged project involving the keenest insight and fullest application of the talents of all the engineers, who have participated in the work. This project has also made almost incredible demands on the patience of the owners, analysts, and regulators to carry on in the face of so many problems until a satisfactory result was obtained. The following is a partial list of primary contributors to the structural renovation of the S/S CORNUCOPIA.

#### West Coast Shipping Company

William A. Hood  
George L. Stiehl  
Garabet G. Kojayan

#### MCA Engineers

Dr. Maxwell C. Cheung  
Vahid Lankarani  
Scott Mattias  
David Harrell  
Ted Alam

#### S/S CORNUCOPIA

Master Phil Roberts  
Master David Olson  
Master George Green

#### Union Chemicals Division

Robert A. Roerig  
Robert D. McMahon  
James M. Peters  
Dewayne D. Korver

#### American Bureau of Shipping

Kenneth S. Amer  
John Fescos  
Phil G. Rynn  
Walter J. Czerny

Chief Engineer Dan McKrola  
Chief Engineer Phil Steele  
Chief Engineer Robert Stanley  
Chief Engineer Patrick Morris

## Introduction

It has been stated that the maintenance costs of a vessel are fully defined as the designer (Naval Architect) completes the design of the vessel. While this axiom is generally true for commercial ships, some marine transportation systems have become so specialized that the fate of the ship's client companies is tied to the success of the ship's design. This latter case describes the relationship of marine transportation to producer to product that exists in the transportation of some chemicals and liquefied gases. In these instances, a failure in the transportation system can have the immediate affect of halting production and distribution of a company's primary product and probably causing the quick demise of the producing company.

The S/S CORNUCOPIA is a 22000 DWT liquefied gas carrier certificated to transport liquefied ammonia or propane, and has been employed in moving ammonia exclusively since it was constructed in 1978. At the present time, the CORNUCOPIA is the only U.S. Flag vessel certified to move ammonia in this way. If the vessel was lost, it would literally require an Act of Congress to substitute a foreign vessel if indeed such a ship was available. Therefore, the CORNUCOPIA has a value which transcends the simple costs of steel and equipment, and becomes in affect a critical element without which an entire business unit fails to function. This situation was made clear at the birth of the S/S CORNUCOPIA.

In the year 1974, the ammonia transportation requirements of Union Chemicals Division were being satisfied through the use of an Ammonia Barge, the KENAI. The KENAI sank in a severe storm in the Gulf of Alaska in October of 1974. The company decided to replace the barge with a ship which they thought would be less vulnerable to weather and, therefore, more reliable. While the new ship was under construction, governmental approval was required for the use of a foreign ship in domestic trade. To save time and reduce costs, a decision was made to create a new ammonia carrier by building a new forebody with cargo containment and attaching it to an existing machinery space. The stern of the new ship would be the S/S SISTER KATINGO, which was a Bethlehem 33000 DWT tanker with steam propulsion machinery built in 1958. The new forebody would be designed by Technigaz and Designers and Planners Inc. and constructed by Todd Shipyard Corp. in San Pedro, California. The existing stern was renovated by Northwest Marine Iron Works in Portland, Oregon, who also joined the new forebody to the stern at Frame 55. The vessel was owned by Union Chemicals Division of Union Oil Company of California and operated by Keystone Shipping Company. The ship was built under ABS Class and ABSTECH also consulted as a member of the construction supervision team. While these participants all contributed to the design and construction

of the S/S CORNUCOPIA, this paper should not in any way be interpreted as a criticism of their work. Rather, the S/S CORNUCOPIA reaffirms the idea that ship design is still as much an art as it is a science, and there is much we still do not know or fully understand about its more subtle idiosyncrasies.

In May of 1978, the CORNUCOPIA was completed and entered into regular service transporting ammonia from Union Chemicals Kenai Plant to Portland and Sacramento. Some years previously, Union Oil Company acquired the assets of Hendy International Company and formed a new ship operating entity under the name of "West Coast Shipping Company". In the early 1980's, Unocal consolidated most of its marine activities under West Coast Shipping Company, including operation of the S/S CORNUCOPIA.

During the transition process to management by West Coast Shipping Company, Keystone and Union Chemicals indicated that the vessel had experienced a number of technical problems since it began service in 1978. These included a propeller slip of 18 to 24%, poor performance of combustion controls with a resultant excess air consumption of 15%, several disfunctions within the reliquefaction facilities, and some scattered structural fractures in certain elements within the ballast tanks and barrier spaces. All of these problems have been addressed and corrected, but the last item, the structural fractures, have required ten years and the expenditure of several millions of dollars to correct. In affect, the ship has remained in continuous operation, while it has undergone a complete structural analysis and renovation process. The processes of the analysis, the repair technique and repair strategy, which permitted the vessel to remain in operation through the renovation period, are the subject of this paper.

## The Vessel

The S/S CORNUCOPIA is a liquefied gas carrier with a mixed framed hull housing independent cargo tanks. There are four major cargo containment structures, subdivided on the centerline to create a total of eight ammonia tanks. (See Figure 3.) The tanks rest on wood supports in the bottom of four holds and are secured by various keys and chocks, which allow the cargo tanks to expand and contract freely in any direction from the geometric center, while restricting movement of the entire tank within the hold boundaries. (See Figures 8 and 9.) The cargo tanks are independent structures made of V062 low temperature steel and would float if the hold space in which they are fitted were to be flooded. To prevent damage to the deck when the barrier space is flooded, the upward movement of the tanks is restricted by antifloatation chocks located on top of the cargo tanks which match chocks attached to the underside of the upper deck. Transverse antipitch keys are fitted at the mid-length of the tanks and antiroll keys are installed along the centerline. These antipitch and roll keys are fitted on both the top and bottom of each cargo tank. These key and support structures are important, since it is through them that the weight of the cargo and dynamic loads are transmitted to the hull of the ship, and through them that deflections in the hull can interact with tank structure. The cargo tanks are longitudinally framed structures with periodic transverse ring frames, centerline bulkheads and vertically stiffened fore and aft end bulkheads.

The forebody includes four cargo holds in which a cargo tank is fitted. The holds or barrier spaces are designed as secondary containment for cargo in the event of a leak in the primary tank. The cargo holds are separated by a 3-1/2 foot wide cofferdam, which includes ballast tanks and access trunks for the double bottom and cargo hold. The double bottom ballast tanks are 5.25 feet deep, extend the full width of the vessel, and are sub-divided on centerline and transversely into eight tanks. There are also eight saddle ballast tanks in the wing portion of the hull under the upper deck and extending over the length of each cargo hold.

The main portion of the forebody of the hull has mixed framing. The bottom and double bottom are longitudinally framed with longitudinal girders and periodic transverse floors. The wing portion of the double bottom at the turn of the bilge and lower two-thirds of the side shell are transversely framed. The upper one-third of the side shell in way of saddle ballast tanks and upper deck are longitudinally framed with longitudinal girders and periodic transverse frames. This mixture of longitudinal and transverse framing results in a very complex support for the hull, causes numerous structural discontinuities, and is

partly responsible for some of the structural problems detailed in this paper. (See Figure 6.)

The bow is transversely framed and integrated with the structure of the midbody in a manner similar to most tanker arrangements. The most unusual feature of the forward part of the vessel is two large holds provided for independent Sulfuric Acid and Caustic Soda cargo tanks. These tanks are used to transport water treatment chemicals to the Kenai plant. The vessel's stern is a conventional late 1950's vintage machinery space structure with transverse framing. The house above the upper deck was rebuilt in its entirety when the conversion to an ammonia tanker was carried out.

In the transverse section, the general scheme of the arrangement of double bottom and saddle ballast spaces resembles the structure of a typical bulk ore carrier. However, close examination of scantlings and structural details reveals a unique and complex structure, which is functionally very different from bulk carrier designs. To make the structural issues more complex, the materials of construction are also unusual. (See Figure 7.)

The CORNUCOPIA was built using ABS Grade V062 low temperature steel for many key structural components. The cargo tanks are constructed entirely of this material as all of the tank structure is subjected to the lowest cargo temperatures. The design temperature for the structure is  $-48^{\circ}\text{F.}$ , as a consequence of certification for propane, but normal operations carrying liquefied ammonia result in cargo temperatures of about  $-28^{\circ}\text{F.}$  The V062 grade material is used for the inner bottom tank top, side shell above the tank top to the saddle ballast tanks, and for the bottom portions of the saddle tanks and upper deck. These portions of the structure are potentially exposed to low temperature cargo if the primary cargo containment were to fail. Also all of the stiffeners and substructures attached to these main elements are of V062 material. Only the bottom shell plating, outboard portions of the deck, and side shell in the saddle ballast tanks are made of ordinary Grade A or B steel.

S/S CORNUCOPIA  
PRINCIPAL DIMENSIONS

Length Overall	623 Feet 9 inches
Length between Perpendiculars	590 Feet
Beam	90 Feet
Depth	53 Feet 9 inches
Loaded Draft Design	29 Feet

ABS Grade V062 material was reclassified in 1983 and is now referred to as Grade V060. This material has the following properties.

Table of Composition and Properties  
ABS Grade V060 Steel

Carbon Max %	.12
Manganese %	1.30 - 1.65
Phosphorus Max %	.04
Sulfur Max %	.04
Silicon %	0.10 - 0.50
Nickel Max %	.80
Chromium Max %	.25
Molybdenum Max %	.08
Copper Max %	.35
Aluminum (Acid Soluble) Max %	.060
Aluminum (Total) Max %	.065
Columbium Max %	.05
Vanadium Max %	.10
Maximum Service Temperature	-55°C or -67°F
Charpy Impact Test	-60°C or -76°F
Tensile Strength	(71-90000 psi)
Elongation	19% in 8 inches
Marking	AB/VH060

The V060 material has a yield strength of 51000 psi.

## The Problem

Almost as soon as the CORNUCOPIA began service in 1978, problems began to appear. Initially, these problems manifested themselves in fractures in the innerbottom tank top at wing knuckle 35.75 feet off centerline and in the bottom knuckle of the saddle ballast tanks. These fractures were characteristically very small, not more than four inches in length, very thin even hairline in appearance and smile-shaped through drain and vent radius cuts in the transverse structure. (See Type 1 and Type 3 fractures in Figure 11.)

As the number of fractures began to accumulate, a number of significant factors began to emerge from collected observations. While many of the fractures penetrated watertight boundaries, only a few of them resulted in water leakage from the ballast spaces to the barrier space. The number of fractures in No. 2 and No. 3 holds near midships was greater than the ends of the ship, and the fractures were concentrated at the center of each hold space with few or none near the end bulkheads. There was also found to be a starboard bias for Type 1 cracks and a port bias for Types 2 and 3. Surprisingly, the crack record showed a switch in concentration for some fractures at midships, where the forward fractures would be concentrated on the starboard side and aft fractures concentrated on the port side (and vice versa). (See Table 1.)

Initially, these cracks were viewed as if they were caused by local anomalies in the structure and treated by welding up the cracks and applying small local reinforcement, such as closing up the adjacent drain and vent openings. This is an almost traditional practice in the marine industry to treat structural problems by the most modest and direct means hoping to avoid the expense of a major redesign or substantial reinforcement. Such a process has merit and often is successful, however, it must be carried out with great care and good judgment since misapplied reinforcement can actually aggravate some structural problems.

After four years and several shipyard repair periods, it became obvious that local reinforcement of fractures in the double bottom tank top and saddle ballast tank would not correct the recurring fracture problem and a more studied approach would be required. A gravity-type analysis of the double bottom structure was carried out by the ship builder but this analysis, unfortunately, did not indicate a cause for the fracture or provide any effective method of repair. It was at this point in 1982 that other business forces intervened and caused the operating management of the vessel to be changed to West Coast Shipping Company. That business decision was purely a policy matter and was not related to

the S/S CORNUCOPIA's structural problems, which the previous operator was working diligently to solve.

As West Coast Shipping Company began to review the vessel's structure problems and their history, it became apparent that the solution of the structural fracture problem was critical to the future success and safety of the ship. Since the cracks penetrated the secondary barrier, this could result in leakage of ballast into the barrier space and increase the heat load on the cargo tanks. Further, if a cargo tank were to leak, the fractures in the secondary barrier could allow cargo to escape from containment and result in an ammonia release. Therefore, we undertook to resolve the structural problem through a two-phased approach. First, the immediate problem of leakage through the secondary barrier would be solved by temporary repairs and, second, the cause of the cracks and a permanent repair would be sought through a thorough and detailed structural analysis.

The limited structural repairs, which had been carried out thus far on the vessel, had been unsuccessful and, in some cases, the welding up of the fractures appeared to make them worse. The cracks in the double bottom knuckle tended to leak into the barrier space, while cracks in the bottom of the saddle tanks tended to remain watertight. As a temporary measure, the ballasting of the double bottoms was limited to remove hydrostatic pressure from the knuckle area and reduce any leakage. An intensive inspection program was undertaken to examine the bottom of the saddle tank and the double bottom tank top frequently and record all fractures observed. Each fracture would be cleaned thoroughly and sealed with a synthetic rubber patch to prevent leakage through the fracture. Since the cracks were very small and difficult to detect, dye penetrant tests were conducted extensively in all of the suspect areas. These inspections and leak sealing repairs were conducted quarterly throughout 1982 and the first half of 1983. During this time, a detailed analysis of the ship's structure was carried out to find the cause for the cracks and develop a method of repair.



## First Generation Solutions

The initial technical investigation of the CORNUCOPIA's crack problem began in 1980 and continued through March of 1982. These analyses were inconclusive and unable to provide a failure diagnosis or a reliable repair technique. The reason for this failure was suspected to be the exclusion of global forces, such as longitudinal bending and torsion from the analysis model. An examination of the fractures, however, clearly indicated certain patterns in distribution of the cracks (i.e. concentrations at midships, a bias to one side of the vessel for certain cracks, and a change in concentration from one side to the other across the midships boundary), which were likely to be caused by hull girder bending and torsion. The initial analysis assumed that gravitational loading due to heaving and pitching was the cause of the fractures. This assumption, however, could not explain failures in the wing tank platings, which were subject to minimal gravity load or why there were concentrations of fractures in frames in the centers of the cargo holds rather than the ends. Such frames were designed to share gravity loads equally. These defects in the initial model led us to conclude that the cracks were caused by other affects and that a more comprehensive analysis would be required to determine the cause.

The voyage profile of the vessel included frequent regular voyages from Union Chemicals' Ammonia Plant in Kenai, Alaska to distribution terminals in Sacramento, California and Portland, Oregon. These voyages caused the vessel to make loaded and ballast transits across the Gulf of Alaska about twice a month, including periods of extremely severe weather. The vessel was further constantly encountering quartering seas either north or sound bound. The oblique waves induced an uneven distribution of buoyancy tending to twist the hull. In particular, the torsional loading along the body of the vessel would fluctuate in a way that fatigue would have to be considered as a possible cause of the hull fractures. To analyze such affects requires a clear understanding of the interrelation of the various structural elements.

The transverse frames in the ship are supported by longitudinal girders and the side shell plating. Loads in the framing then are resolved into forces transmitted by the longitudinal members and unloaded in the transverse bulkheads and cofferdams. At the mid span of each hold between the cofferdams, the longitudinal bending moment is higher and this affect, combined with transverse bending and torsion, could cause the web frames in the middle of the hold to be more susceptible to fracture than those at the ends of the space.

To calculate the absolute stress in the web frames under this complex system of loads and identify the stress concentration areas, it was essential to have a three dimensional fine mesh model constructed with sufficient detail in the fracture area to identify the problem, but with enough definition in the global sense to properly reflect the actual distribution of loads through the structure. It is important to note here that we had a number of critical advantages over the ship designer and classification society, who analyzed the hull before it was constructed. We knew where the cracks were occurring. We also knew that the fractures were very small and that an extremely fine mesh model would be required to detect them in an analysis.

In order to calculate the absolute stress levels in the critical areas of the hull girder, it was necessary to have a very fine mesh three dimensional model of the hull, which was capable of handling all the applied loads including longitudinal bending, transverse bending, and torsion. In order to accommodate these different types of loads and different fracture sites while maintaining the most realistic model possible, it was decided that the mathematical model would include every frame (approx. 40) for the length of one tank (No. 3 Hold) and to model both sides of the ship. However, this problem was undertaken in 1982, when personal computers were still very primitive, and, consequently, the problem had to be solved on a mainframe system and was limited in complexity by the size of the computer. The modeling of every transverse frame in a tank using a fine mesh model throughout was obviously impractical, if not impossible. To resolve the impasse, a technique called "substructuring" was used. (See Figures 16 thru 21.)

In a substructure model, the target area of interest for the analysis is modeled in extremely fine detail and the boundaries of the fine model are then attached to a more coarsely defined model segment of a frame, the frame is completed with larger elements since other areas are not of great interest, except as they interact with other structures in the overall pattern of load distribution. Finally, the individual frames are assembled to complete the structure for an entire tank. It should be kept in mind that for the CORNUCOPIA model, a fine mesh substructure was created to describe the elements around the innerbottom knuckle and at the bottom of the saddle tank. Each of the 40 web frames, and both port and starboard sides, included the fine mesh substructure.

Another key element in the structural analysis process is the determination of the loads to be applied to the structural model. In the case of the S/S CORNUCOPIA, the American Bureau of Shipping had done an analysis of the vessel's design before the ship was constructed. The ABS performed longitudinal strength calculations, derived various load and ballast conditions for the vessel, and used a dynamical

system of analysis (SHIPMOTION and DAISY) to derive loads on the ship's structure in various sea conditions. After considerable review of the various conditions studied by ABS and calculation of some sample results, we picked their Load Case 6, as the most severe loading of the ship structure, and a case that was most likely to be contributing to the fracture problems the vessel was experiencing. This case took the vessel to be operating in a dynamic state with a full cargo load, a heel to port of  $32^{\circ}$ , a wave angle of  $60^{\circ}$  off the port bow, a wave length equal to the vessel's length, and a wave height of 50 feet 10 inches. For this condition, the ABS had derived boundary forces at frames 96 and 182, and cargo tank support forces. These are the forces that would be applied to the structural model. (See Figure 12 thru 15).

The new Finite Element Analysis of the structure of the CORNUCOPIA was carried out using the ANSYS program and the "substructuring" technique. This technique is more advanced than conventional finite element analysis because it makes possible the assembly of fine mesh detailed models into one coarse mesh global model, while permitting stress concentrations at local areas to be resolved at the level of solving the global model.

All Finite Element Analyses in the early 1980's used the same basic principles in solving structural problems as follows:

1. Formulate the stiffness coefficient for each element.
2. Assemble the global stiffness matrix.
3. Invert the global stiffness matrix.
4. Apply the system of external loads.
5. Compute the nodal displacements.
6. Apply the nodal displacements to compute element stress.

Each node in the model is represented by six (6) Degrees of Freedom and each Degree of Freedom is represented by one equation in the global matrix. The connectivity of the element determines the band width of the matrix. It is not difficult to visualize the geometric expansion of the matrix for a large structural model. Therefore, a general purpose Finite Element Analysis program would require large storage capability in the computer to solve a large structural problem. To alleviate this difficulty, a coarse mesh model can be used, but this may result in a loss of resolution in critical area of fracturing. Another way to solve the problem is through the "substructuring" technique, where fine mesh modeling is used in the critical area and coarse model is developed to outline the interconnecting main structure.

In the case of the CORNUCOPIA, No. 3 hold space extends for a distance of 98 feet 4 inches and from frame 97 to frame 139. In this span, there are nine (9) main web frames spaced 9 feet 4 inches apart. Between two main web frames, there are three ordinary frames spaced 2 feet 4 inches apart. These two types of frames are assembled in the appropriate sequence to make up the global model. Through the process of merging the substructures and global structure, the model retains the stiffness character of every detail within the fine mesh segment, but only the exterior boundary nodes must be entered into the global stiffness matrix. The substructuring technique, therefore, permits solving a complex problem in one step, which would be impossible with an ordinary Finite Element Analysis program.

Even with the use of substructuring, the CORNUCOPIA problem was an ambitious undertaking. The structural model included some 7500 nodes with each node having six degrees of freedom. Solution of the global stiffness matrix required the use of the largest computers then available, the Cray 1 Computers then owned by Westinghouse at Pittsburgh, Pennsylvania and by Boeing at Kirkland, Washington.

Work on the analysis of the CORNUCOPIA structure began in the second quarter of 1982 and several months were required to debug the structural model. Late in 1982, meaningful results were obtained and an analysis of the stresses in the ship's structure could begin. Figures 22 thru 26 indicate how the principle stresses in the structure were mapped on diagrams to examine how the stresses were distributed in the critical fracture areas. The highest values in each area are then indicated in Tables 2 and 3. The locations shown as 1/2L or 1/4L indicate positions at 1/2 or 1/4 of the length of No. 3 hold space.

The stress results obtained from the analysis indicated that the maximum stresses in the area of the lower tank top knuckle and saddle tank bottom as expected by the known locations of fractures. The lower tank top knuckle had the higher stress, stress was also higher at web frames than ordinary frames, and stresses were higher in the middle of the tank than at the ends. All of these results correlated well with the fracture history. The fine mesh model also indicated that the area of excessive stress was extremely small and involved spaces not more than a few inches in diameter. Such a small flaw was unlikely to be uncovered by the kind of coarse analysis typically done in the design stage of ship construction projects. It was also observed that the model predicted stress above the yield of the material indicating that fractures could be expected immediately after the ship entered service, which also corresponded to actual experience.

The next steps in the analysis were to diagnose the cause of fractures and develop an effective method of repair. This proved to be an unusually difficult endeavor, since the high stresses indicated in the analysis were in compression and not tension as we had expected. To identify the causes of the fractures, the stress output of the Finite Element Analysis was transferred to sketches of the structural model. (See Figures 22 thru 26.) After reviewing a number of competing scenarios of failure, it was finally concluded that the vessel's structure had, in fact, yielded in compression in a small area subject to the highest stresses. The compressed material would then be subjected to tension when the cyclical dynamic loads relaxed and that these oscillations caused the cracks to initiate and propagate. Since the field of excessive stresses was very small and the surrounding area was subject only to very modest stresses (12 to 15 ksi), the cracks propagated only a very short distance and stopped. Further, as the principle stress was compressive, the cracks tended to be tightly sealed and most did not leak even under hydrostatic pressure. Having apparently achieved a satisfactory explanation for all of the observed peculiarities of the fractures, the analysis switched from diagnosis to treatment.

A number of repair models were developed to absorb the stresses indicated in the results of the structural analysis. Since we wished to use the structural model to test the adequacy of the repair technique, and since further computer analysis was expensive and time-consuming, it was imperative that the proposed repair be carefully developed, so as to achieve a complete reduction of the excessive stress in as few trials as possible. This repair development process proved to be very difficult and continued from January 1983, when the final diagnosis of the problem was achieved, until August of 1983, when the ship entered the yard for repair. In fact, the last tests of the repair model were not completed until after the ship had entered the shipyard. (See Figures 24 thru 31.)

The first structural reinforcements designed for the CORNUCOPIA were applied to the ballast space side of the structure to avoid the necessity of removing perlite insulation from the barrier space and prevent damage to the tank block insulation for the cargo tanks. These initial attempts were totally unsuccessful and reinforcements then were designed for application from the barrier space side. The first attempt at reinforcement in the barrier space reduced stresses in the critical fracture areas but caused excessive stresses in other areas. The effectiveness of the reinforcement elements proved to be extremely sensitive to shape and dimensions and many trials and adjustments were necessary before the final design was achieved.

The repairs developed to prevent the innerbottom and saddle tank fractures are shown in Figures 32 thru 36.

The innerbottom reinforcement is a heavy triangular bracket fitted at the tank top knuckle in way of each main web frame. In addition to the bracket, a doubling plate is provided at the knuckle and as a tail off pad at the upper end of the bracket. The saddle tank repair included closing of drain holes at the inboard knuckle of the tank bottom and installation of a kite-shaped bracket with both transverse and longitudinal elements at the bottom of the saddle tank in way of every ordinary frame and every main web frame. This kite bracket had the feature of bypassing loads from the sloping bottom of the saddle tank to the side shell transverse frames around the knuckle in the tank bottom plating. Numerous copies of these reinforcements were made and installed on both sides of all four barrier spaces on the vessel. All 312 of these reinforcements were constructed of V060 material.

Before the vessel entered the shipyard for repair, all of the perlite insulation was removed from all of the barrier spaces to provide access to both sides of the critical fracture area. The CORNUCOPIA's structure was thoroughly examined to locate and identify all new and existing fractures, all fractures were examined using magnetic particle or dye penetrant methods, prepared, and permanently welded. The structural reinforcements as described were installed and have been in service from 1983 to the present time. The repair and reinforcement work was started at Northwest Marine Iron Works in Portland, Oregon. Due to a West Coast shipyard strike, which began while the vessel was on dry-dock, the repair work was temporarily suspended and completed later in the year at Mitsubishi Heavy Industries in Yokohama, Japan.

The repairs developed through the structural analysis have been very successful and there has been no further recurrence of the fractures treated by this work. Unfortunately, the structural problems of the S/S CORNUCOPIA proved to be far more extensive than previously thought and further analyses would be required.

## Second Generation Structural Failures

As the solution to the saddle tank and double bottom fracture problems began to be applied, new and equally important structural problems began to appear. The new fractures were found in the course of thorough and meticulous examinations of the structure, while the ship was in the shipyard. The areas of fracture included the following locations.

1. Fractures at the weld joining the upper side frame brackets to the bottom of the saddle ballast tank in No. 1 hold.
2. Fractures of the attachment of lower side frame brackets to the tank top in No. 1 and No. 4 hold.
3. Fractures of the tank top at the inboard end of lower side frame brackets in No. 1 and No. 4 holds.
4. Fractures in the inboard sloping side plating of the saddle ballast tanks at the termination of main transverse web frames.
5. Fractures in under deck longitudinals in the port and starboard deck crane foundations.
6. Fractures at the lower end of forward ice frames.
7. Fractures in under deck longitudinals under the main deck vent masts.
8. Fractures in main deck plating in way of the corner of the cutout for the penetration of No. 3 tank dome through the upper deck.
9. Fractures at the port and starboard corners of the compressor house in way of the attachment to the upper deck.
10. Fractures in way of brackets connecting the compressor house forward bulkhead to the upper deck.
11. Numerous fractures in under deck longitudinals and girders and intersections with transverse members, intersections with key and chock structures, and at various abrupt changes in depth of these members.

The first six items listed above were treated as local issues involving inadequate design details. These faults have been reduced without any computer analysis. The last five items, however, have been found to represent an extensive problem of inadequate support for the upper deck due to insufficient reinforcement to compensate for the major penetrations of the deck in way of the tank domes. Many of these fractures may

have existed in previous years, but they were not cataloged until 1983.

Since the ship was in the shipyard when these problems were uncovered, there was an immediate and rather massive effort to apply additional reinforcement to the upper deck. The depth of many of the under deck longitudinals was doubled wherever there was an abrupt transition, such as at diaphragms or partial girders. Triangular brackets were also applied to extend the transition of diaphragms to shallow longitudinals. Face plates of girders were reinforced and the connections of longitudinal and transverse structure to keys and chocks were revised.

Initially, it appeared that the reinforcement of the under deck structure would perform satisfactorily and resolve the problems, but within two years under deck cracks began to reappear. From 1983 through 1985 repairs to faults listed as items 1 through 6 above were monitored and a few additional changes to existing structural modifications were made. When additional inspections were made, it was found that fractures of types 7 through 11 were recurring and further cracks had developed at the intersection of longitudinal and transverse girders under the upper deck. Some of these cracks extended for the full 40 inch depth of the members and terminated in a small smile-shaped fracture in the upper deck in way of a vent cut near the girder intersection. The cracks in the upper deck at the cutout for the dome penetration also reappeared.

As fractures in the under deck support structure began to recur and, in some cases, increase in severity, it was obvious that additional reinforcement was necessary and that a comprehensive analysis was needed to insure that the repairs would be effective. In 1986, a new structural model of the CORNUCOPIA was constructed with a fine mesh model of the upper deck connected to a coarse model of the remaining structure of the hull. To insure the safety and continued performance of the ship, while the analysis was under way, it was decided that the ship would be surveyed every six months in Portland, Oregon to identify any structural failures in under deck members, and that any fractures found would be immediately repaired. With a few exceptions, no further reinforcements were attempted pending completion of the new structural analysis. The inspections and temporary repairs were restricted to No. 2 and No. 3 hold spaces, as these were the only areas where a severe crack problem continued to be observed.



## Second Generation Structural Analysis

The fractures, which were observed in the under deck structure of the S/S CORNUCOPIA, can be cataloged into several distinct classes as follows. (See Figure 41.)

- Type 1            Fractures at the connection of longitudinal girders and antipitch keys.
- Type 2            Fractures in under deck longitudinal 5 from centerline in way of intersections with transverse members.
- Type 3            Fractures in under deck longitudinal 4 from centerline in way of transition to the partial longitudinal girders at the same location.
- Type 4            Fractures in under deck longitudinal 7 from centerline in way of transitions to partial longitudinal girders and diaphragms in the same location.
- Type 5            Fractures in the centerline under deck longitudinal in way of transverse members and transitions to partial longitudinal girders and diaphragms.
- Type 6            Fractures at the connection of partial longitudinal girders to transverse web frames.
- Type 7            Fractures in the upper deck at the corners of the penetration for the tank dome.

All types of these fractures have been recurring in recent years after several attempts at repair and direct reinforcement. The cracks have been concentrated near midships with the most in No. 3 hold, a large number in No. 2 hold, and a few in No. 1 and No. 4 holds. All of the fractures to under deck stiffeners appear to initiate at the lowest flange or fiber and propagate in the direction of the deck plating. If left unattended, most cracks completely sever the member or connecting welds for the full depth of the element. For the under deck girders, this means a 40 inch long crack. Fortunately, the rate of propagation of these fractures appears to be rather slow and related to the most severe weather conditions. Periodic inspections and repairs at six to eight month intervals has proved adequate to identify the fractures and repair them without a major incident or problem.

Type 6 and 7 fractures can involve cracks in the upper deck. Such fractures have been found to be very small and apparently do not tend to propagate. Fortunately, the vessel

has an excellent detector for this type of crack. Deck fractures result in losses of nitrogen pressure from the barrier space. As a pressure loss or excessive consumption of nitrogen is observed, the ship's crew automatically begins a survey of the deck for possible fractures and can often find them with a soap test.

Examination of the structure in the vicinity of the cracks has indicated that there is a high correlation of fractures with abrupt changes in depth of longitudinal members. Acting on this observation, a number of brackets and other reinforcements were added, which served to taper or soften the changes in depth. These modifications, in many cases, caused new fractures to occur at more benign locations, but did not permanently correct the fault. The concentration of fractures in No. 3 hold might also be related to discontinuities in local arrangements, such as the compressor house and ammonia deck tank, which are situated above No. 3 hold.

Having failed to solve the deck fracture problems by other means, we decided to again resort to a detailed analysis of the structure using finite element techniques. Since the time frame of the work had now advanced to 1987, new tools were available with which to attack the problem. At this time, new, faster and more powerful personal computers were available and there was new software which could be used to solve finite element problems.

The Structural Finite Element program used to analyze the CORNUCOPIA's upper deck was "STARDYNE". The basic principal of using static structural programs to simulate the structural response was the same technique, which was adopted in 1982 to analyze the inner bottom tank top and saddle tanks, but with the new program a different method of modeling was adopted. The earlier analysis used the substructuring technique to represent every detail of the frames and stiffeners in one giant structural model. The consequence of this system is a gigantic stiffness matrix, which only the largest computers are able to manipulate. The convenience of this one-step solution, however, is overshadowed by the high computer expenses and the work of debugging the structural model.

The new structural analysis was by a completely opposite approach to the work which had been done in 1982/83. The modeling was broken down into three stages, with each subsequent stage zooming into a smaller region, resulting in a finer mesh model than the previous stage. Effectively, this breaks up the gigantic stiffness matrix into several smaller ones, such that a smaller computer may be used to handle each stage separately. The technique reduces the cost of the computer analysis, but requires more time to complete the work since the processing of one stage depends upon the results from the previous stage. All three stages

must be reprocessed every time the loading conditions change or when there is a significant change in the structure. There are also three sets of boundary conditions to consider, and the model must be carefully designed to insure that the target area of the analysis is well clear of the boundaries of the different stages of the model.

For the S/S CORNUCOPIA deck analysis, the first stage model consisted of the global structure for cargo hold No. 3 from the aft cofferdam at frame 96 to the forward cofferdam at frame 140. The double bottom was modeled as a single layer of orthotropic plates with the equivalent stiffness of the floor girders and frames included. The side shell was modeled as orthotropic plate with no stiffening in the longitudinal direction. The deck plating was modeled as orthotropic plate, including the longitudinal stiffeners and transverse frames. The upper saddle tank plating is also orthotropic with longitudinal stiffeners included. The external loads are applied at bulkhead 96, pitch and roll key loads were applied at the deck and bottom, and hydrostatic loads were applied at the side shell and bottom. Bulkhead 138 was assumed to be fully restrained from all translative motion. (See Figure 38.)

The second stage model consisted of the deck structure that spans from the inboard boundary of the port saddle tank to the inboard boundary of the starboard saddle tank. All major girders, both longitudinal and transverse, were modeled as isotropic plate elements, while the under deck longitudinals were modeled as beam elements. Since this model represented a freebody cut from the first stage model, the internal forces in the first stage model at the interfacing points became the external loads for the second stage model. (See Figure 39.)

The third stage model included the corner of the deck opening for the cargo tank dome and was bounded longitudinally by frames 118 and 123.5. The transverse boundaries were the ship's centerline and a longitudinal girder 11 feet off centerline. Unlike the other two stages, the corner model was analyzed using the SUPERSAP Finite Element program. This change was adopted because of the superior graphics and model generation capabilities of the software. Since SUPERSAP did not output internal forces of the analyzed model, it could not be used for the first or second stage analysis. All details in the third stage model were created using isotropic plates and, like the other cases, the applied loads were obtained from the preceding model. Since none of the boundaries of this model extend to the rigid boundary of the first stage model, the set of external forces must be in total static equilibrium. Also it is critical that the target area of the analysis be well clear of the boundary of the model. (See Figure 40.)

The loading of the full hull model (first stage) was derived from forces given by the American Bureau of Shipping in their original analysis of the ship's structure prior to construction. As discussed previously, load case #6 (See figures 12 thru 15), which includes longitudinal bending, lateral bending, torsion and hydrostatic loads in an oblique sea, was adopted as the worst case. The loading in stages 2 and 3 are composed entirely of equilibrium forces from the previous stage and thus only the loading of the first stage must be carefully considered and selected. Vertical and lateral bending moments at station 96 are applied to the first stage model as concentrated nodal loads. Since the moment of inertia of the ship's hull about the vertical and horizontal axes was previously computed for the 1982 analysis, that work could be used directly in the current analysis. The stress at the centroid of each element of the structure was calculated by the beam bending method and the resultant force was derived and divided equally between the two nodes of the element that lie on the free boundary at bulkhead 96. All forces arising from bending moments are applied in the Z direction (longitudinally), positive on one side of the neutral axis and negative on the other depending upon the direction of the moment.

The shear forces given by the ABS analysis are also applied as concentrated forces to nodes lying on the free boundary. The shear force was divided amongst the various structural elements according to the percentage of the total cross-sectional area they represented. As with the bending moments, the resulting element force is applied equally to each of two nodes along the free boundary. Only the elements that model the side shell and the longitudinal floors included vertical shear, since they are the continuous members of the hull girder with large depths that effectively bear the shear load. Similarly, the main deck plating along with the inner and outer bottom plating are the only structural components associated with lateral shear.

The torsional moment, like the bending and shear, was applied as a force to the nodes at the free boundary. This situation was simplified by assuming that (a) the deck and bottom plating plus the side shell forms a closed tube-like structure that bears all the shear load due to torsion, (b) the deck, bottom and side shell are of uniform thickness, and (c) the deck and bottom have the same thickness. These assumptions, while not entirely accurate, were considered conservative since they tend to slightly exaggerate the effects of the relatively small torsional moment. Based upon these assumptions, the shear forces were derived and distributed to the nodes as described for lateral and vertical shear.

The hydrostatic pressure on the hull is applied to the model as a concentrated force at nodes of the "wet" elements.

Unlike forces and moments, hydrostatic forces are applied along the full length of the node and not just on the free end. The hydrostatic head on the sides of the ship were also obtained from the 1982 analysis. Assuming that the water level is constant along the length of the tank, the pressure is calculated at each row of "wet" nodes and a force is assigned to the node according to the amount of area surrounding it. In the case of the elements near the turn of the bilge, the components of the resultant normal force are applied to the model. In the analysis, the port side is subjected to a higher hydrostatic pressure than the starboard due to the large angle of heel. In reality, the starboard side will experience a similar hydrostatic load as the vessel rolls during the next half cycle. In interpreting the results of the analysis, it is important to remember that high stresses exhibited on one side of the vessel necessarily indicate a high stress in the corresponding position on the other side.

Cargo tank loads, arising from the fully loaded tanks and the dynamic movements, are obtained from the ABS analysis in 1975. These loads apply only to the cargo tank supports, antiroll keys, and antipitch keys and are applied like other forces or concentrated nodal forces. (See Figure 15.)

Since the stage one model has a coarse element grid and consists primarily of orthotropic plates, it is not important, nor realistic, to interpret the actual stress level from the contours of this model. Rather, the results are used to detect high stress regions for reference and to generate internal forces for application to the second stage model. The maximum principal stress contours for the top port and starboard sides of the deck have indicated, for example, that the intersection of the longitudinal deck girder and frame 122, as well as the dome opening corners, are relatively high stress areas. (See Figure 42.)

The second stage deck model is composed primarily of isotropic plates, but the density of the element mesh is not great enough to yield accurate stress results in the target areas. However, it is clear from this model that the forward starboard and aft port corners of the dome opening have high concentrations of tension stress (See Figure 43), the higher stress being 40 ksi at forward starboard corner. The highest stress appears at the forward part of the deck near the rigid boundary where the nodes are held fixed. Such local stress concentrations are common around points where the load is applied or where the model is fixed, but the critical area of the corner of the dome opening is sufficiently removed from the edge of the model to be unaffected by the rigid boundary.

The results of the second stage deck model indicated that the diagonally opposite corners of the dome opening had similar stress levels, and that the forward starboard and aft port

corners were both in tension, while the other two corners had higher compression stresses. The deck was found to be subjected to a torsional moment that tended to twist the structure about the longitudinal axis. This twisting of the deck caused in-plane shearing forces, that tend to warp the dome opening shape resulting in two acute angles (compressive stress) at the corners.

The third stage corner model is entirely isotropic and has sufficient mesh density to achieve accurate stress results in the plating at the corner of the deck opening. The corner model represents the forward starboard corner of the opening and exhibited extremely high stresses 166 ksi towards the after side of the rounded corner (See Figure 43). This area is approximately the area where the cracks have actually occurred on the vessel. Of course, the absolute value of the stress is only representative, since it exceeds yield and, therefore, is beyond the linear limitations of the analysis.

Since the analysis of the deck structure indicated high stresses in the area of known fractures, it is assumed that the model correlates well with real performance and that repairs developed using the model would be effective. After identifying the cause of the fractures, the problem of developing an adequate reinforcement for the deck could be undertaken.

Since the difficulties in the upper deck structure appeared to be closely related to the presence of the large opening for the cargo tank dome, considerable thought was given to designing alternative load paths around the opening to mask its presence. Various arrangements of diagonal girders were devised and added to the model at the under side of the upper deck. These new girders showed almost immediate results in reducing stress levels at the corner of the deck opening and other areas where fractures had occurred. Unfortunately, the end connections of many of the new girders exhibited very high stresses as well as at other areas of the deck, which had not previously been subject to fractures. However, the results were encouraging and indicated that further development might be successful. To control the cost of repair, a minimal system of reinforcement was tried first, and more complex modifications were added gradually to determine the minimum amount of reinforcement necessary to resolve the problem. Each day a new model would be developed, the structural response would be calculated overnight, and the results reported by fax the next morning. This process and the refinement of the repair continued for weeks until a satisfactory repair was developed.

After the reinforcing structure was added to the model, the results of the first stage model appeared to be very little different from the original structure. This was expected because of the relatively crude nature of the first stage

analysis. The stress levels in the full hull model are, therefore, ignored and the internal forces are applied to the second stage model. The second stage model showed significant improvement over the unreinforced model. (See Figure 46.) The stress concentrations at corners of the dome opening, for example, were reduced to 10 to 15 ksi from a previous level of 40 ksi. The principal effects of the reinforcement were (a) an overall reduction in stress levels for the entire deck, (b) higher stress concentrations were moved away from the corners of the deck opening to less vulnerable areas, and (c) warping of the deck opening due to twisting of the deck structure was not as apparent as the original unrepaired model.

The third stage model showed the most substantial reductions in stress when compared to the original structure. The maximum stress on the deck was reduced to 33 ksi. The stress concentrations near the round corner of the deck opening shifted to the forward side of the corner and fell dramatically from 166 ksi to 13 ksi. (See Figure 47.) The under deck girder intersections, reinforcing members and other under deck structure exhibited equally favorable results. Unfortunately, however, the additional diagonal girders needed to produce this result were very large, and resulted in a complex and elaborate modification to the under deck structure. (See Figures 41, 48 and 49.)

After development of a repair model for the upper deck, the next several months were spent completing a drawing of the new under deck girders and the details necessary to integrate them into the existing structure. The repair plan was sent to repair yards in Japan and Portland, Oregon for review. After careful study of the plan, the repair contractors reported that the reinforcement was nearly impossible to construct without removing the entire deck over No. 3 hold. Since such an operation would be prohibitively expensive, the repair plan had to be discarded and a new arrangement developed to cure the deck fractures.

## The Final Analysis

After such a monumental effort to solve the seemingly intractable problem of correcting the faults in the upper deck of the CORNUCOPIA, it is understandable that the participants were rather discouraged that the repairs could never be realized. From this point, the better part of another year passed with temporary repairs continuing while a new idea was sought. During the initial phases of the deck analysis, a decision was made to restrict the repairs to the barrier space at the under side of the upper deck. This was done because of the amount of low temperature cargo piping and other interferences above the deck, which would be very expensive to relocate or modify. At the suggestion of naval architects from Mitsubishi Heavy Industries in Yokohama, the idea of above deck reinforcement was reconsidered. The vessel was visited by a number of engineers at the loading terminal in Kenai, Alaska. The arrangement of longitudinal girders and transverse web frames was mapped out on top of the deck in chalk, so that the location of possible interference problems could be identified. What emerged was that the interferences with piping and instrumentation, in way of No. 3 cargo hold, appeared to be less significant than previously thought.

The new reinforcement plan for the S/S CORNUCOPIA was to install deep flanged girders above deck, which were exactly in line with similar members and longitudinals below deck. The new girders would be of a similar depth to the under deck girders (40 inches), and would be tapered off at the sides in way of the saddle ballast tanks. The reinforcement would extend from the forward bulkhead of the compressor house and terminate at the cofferdam (frame 138) at the forward end of No. 3 hold. Mock up segments of the girders with flanges were made of plywood and moved around on the deck to identify all the possible interference problems. After this survey was completed, it was concluded that reinforcement above the upper deck was feasible, but further analysis was required to determine if such reinforcement would actually solve the structural fracture problem.

A new analysis of the CORNUCOPIA's upper deck was begun again in earnest in early 1990. The global model of the hull, which was constructed for the 1988 analysis, was reused, while the second and third stage models were modified to include the new above deck girders. The first two stages of the model were again analyzed using the STARDYNE Finite Element program and the third stage results were obtained using SUPERSAP.

As in the 1988 analysis, the first stage model provided an approximation of the hull of the S/S CORNUCOPIA using orthotropic plates, which combined the longitudinal and transverse



stiffness characteristics of the hull plating as well as most of the attached stiffeners. The model extended from bulkhead 96 to 140, which incorporated all of No. 3 hold and included the side shell saddle tank and upper deck. (See Figure 50.)

The second stage model of the analysis was a segment of the upper deck between the saddle tanks and extending for the length of No. 3 hold. All the structures in this model were modeled as isotropic plates and included all longitudinal and transverse structure under the upper deck. The above deck reinforcing girders were added to this model as 40 inch deep, 1 inch thick members with 18 inch wide, 2 inch thick flanges. The lower part of the compressor house was also included in the model. (See Figure 56.)

The third stage model of the upper deck incorporated a corner of the deck opening for the tank dome and extended from the centerline to a girder at 11 feet off centerline and for a length from frame 118 to 123.5. In this model, the reinforcing longitudinal and transverse girders were added explicitly as isotropic plates including the flanges of these girders. (See Figure 60.)

The results of the analysis of the reinforced deck proved to be very encouraging. In the second stage model, the stresses were substantially reduced at the intersection of the longitudinal and transverse girders under the deck. Also, the new reinforcing girders were loaded indicating that they were picking up part of the stress and reducing stresses in other areas. (See Figures 51, 53 and 54.)

The third stage model indicated that the stresses in the corner cut for the dome were greatly reduced down to really modest levels <10 ksi. The detailed model indicated stresses along the edges of flanges of longitudinal girders adjacent to the deck opening switched to the opposite side of the flange at the intersection with the nearest transverse web frame. This was an effect of the loads near the deck opening tending to compress the diagonally opposite corners, while simultaneously opening the other pair of corners. This diagonal distortion had clearly been responsible for some of the under deck fractures, and was being caused by the torsional loads on the structure.

After carefully considering the results of the deck reinforcement technique, it was observed that, while the stress in the critical fracture areas was greatly reduced, the load on the reinforcing members appeared to be rather modest. So modest, in fact, that a reduction in the size of the reinforcement could be considered. A new model of the deck was prepared in which the reinforcing girders were reduced in depth from 40 inches to 24 inches, and the flanges on these girders were reduced from 18 inches in width to 12 inches. These changes in the reinforcing members were incorporated as

isotropic plates and beams in the second and third stage models of the upper deck. The assumed loads from ABS Case 6 were applied to the system and the results plotted as in the previous analysis.

As before, the study of the new reinforcement resulted in significantly reduced stresses in the corner of the upper deck opening for the dome and at the intersection of the longitudinal and transverse under deck girders. While the absolute value of these stresses increased slightly over the previous model, the stresses were still in an acceptably low range. (See Figures 57, 59 & 61.) As expected, the stresses in the reinforcing members increased, but this affect was minimal and the net result was a successful repair design.

At this time (Summer 1990, Mitsubishi began in earnest to plan for repair of the S/S CORNUCOPIA and arrange for all the detailed modifications, that would be necessary to handle the interferences caused by the above deck reinforcement. Gary Kojayan of West Coast Shipping Company worked with Dr. Cheung of MCA Engineers to develop a complete and detailed plan of the reinforcement structure. Details of the deck structure plan were found to be quite critical in terms of the success of the overall repair, since experience with the CORNUCOPIA has shown clearly that crude or ill-conceived structural details often failed in service.

In particular, certain details of the above deck reinforcement required the interplay of all participants, including West Coast Shipping Company, MCA Engineers, and the American Bureau of Shipping. The intersection of the longitudinal girders above deck with the front of the compressor house was modified numerous times to ensure secure attachment to the compressor house, and provide a load path to the internal false deck and side bulkheads. Even prior to the analysis of the structural model, it was well understood that part of the reinforcing girders would have to pass through the base and foundation of the ammonia deck tank. After the analysis was completed, a detailed design had to be developed, which maintained the division between the base of the tank and the foundation. Experience with other structures on the CORNUCOPIA has also indicated the criticality of end connections and terminations. With this in mind, a rather elaborate arrangement was developed to taper the forward ends of the new longitudinal deck girders at the forward cofferdam (frame 138), and the ends of the transverse girders in way of the saddle ballast tanks. (See Figures 62, 63 and 64.)

The study of the upper deck and its reinforcement was based entirely on the loads developed by the American Bureau of Shipping for Load Case 6. This was done because experience with the analysis done in 1982 indicated that this case, which included torsion, was the most severe combination of loads. However, Load Case 1 from the same ABS study, which

involved direct bow waves, produced a higher vertical bending moment. Since the vessel had been allowed a higher allowable stress as a consequence of the use of the V060 material, the stresses produced by Case 1 were acceptable for the existing deck, but would not be suitable for the deck reinforcing material unless that material was similarly of a higher strength category. Therefore, the entire system of upper deck reinforcing girders would be constructed of ABS Grade DH32 material for the longitudinal girders with 24 inch deep, 3/4 inch thick webs and 12 inch wide, 1-1/2 inch thick flanges. The transverse girders have 1/2 inch thick webs and 1 inch thick flanges and were to be made of ABS Grade D material.

The S/S CORNUCOPIA entered Mitsubishi Heavy Industries, Yokohama shipyard on November 17, 1990. The upper deck reinforcement was carried out in accordance with the approved plans and the vessel returned to service on December 2, 1990. In the year since the reinforcement of the deck was completed, we have experienced a few minor fractures in end details of the reinforcing structure. As expected, the unreinforced area of No. 2 hold has continued to operate as before the modification. While there have never been any cracks in the deck at the dome opening in way of No. 2 hold, there have been numerous fractures in the longitudinal and transverse under deck girders and under deck longitudinals. In the past year that trend has continued, although there may be a slight reduction in quantity and extent. Based upon this experience, we have decided to move ahead with further reinforcement of the deck. New drawings have been prepared which extend the above deck repair girders to cover the No. 2 and No. 4 holds. These new reinforcements will be essentially identical to the girders installed above No. 3 hold, and will be connected to them longitudinally as continuous extensions of the same structure. No new analysis has been done, since we are confident that the new modification will achieve as good or better results as the previous installation for No. 3 hold. There has been no consideration given to reinforcing the deck at No. 1 hold, since there have been only a few under deck fractures in that area of the ship.

The latest strengthening of the upper deck of the CORNUCOPIA will be done in Yokohama, Japan on October 16, 1991. We hope and expect that this will be the last major modification, which will be made on this vessel. We do not expect that the occurrence of structural fractures will end. Due to fatigue and excessive loading, some of the existing structure may be subject to further failures, but the number and extent of future fractures should be substantially reduced from the kind of failures the vessel is accustomed to experiencing. If such a pattern develops, as is hoped, then further structural renovation will not be required.

## Strategies for Success

The structural renovation of the S/S CORNUCOPIA has been a long, difficult and, sometimes, tedious process and may yet not be completed. To the participants, the success already achieved in reducing the number of fractures and eliminating several classes of cracks, has been very rewarding. This success can be attributed to a particular strategy that has been in use throughout the renovation process.

The structural renovation of the S/S CORNUCOPIA has been a highly technical process. It has involved some of the most powerful analytical tools, extremely complex structural models, some techniques were used for the first time in the study of CORNUCOPIA's structural problems, and the largest and most powerful computers have been used in the analysis. It would appear on the surface that any problem must succumb to such powerful forces arrayed against it but, at each step in the path towards solving the problem, there have been numerous discouraging, near misses, which could have thwarted the final result. Quite unexpectedly, it has been the insights and contributions of the individual people involved, their varied backgrounds, and the interplay of their experience, which have been the most important factors in achieving success in this project.

It is frequently the case that a particular vessel design contains flaws in structural details which are partially intractable. It is also common for the vessel owner or operator to collect a history of fractures and then dump this data on an engineering consulting firm, provide a fixed budget for some analysis, direct the engineers to "Fix the Ship", and then walk away expecting a solution to all the problems to miraculously appear after a few months of work. If any one has experienced a satisfactory and successful solution to a severe structural problem by this procedure, they should be considered extremely lucky. The usual consequence of such a process is a unanimous agreement by the consultant that the vessel does have a problem.

In the case of the renovation of the S/S CORNUCOPIA, the following processes were undertaken in which the owner and engineering consultant participated together, so that the most information could be obtained, and the best operational procedures could be adopted having the greatest possible direct bearing upon the problem.

1. The vessel's trading pattern and voyage profile were reviewed in detail, along with an analysis of log book data, and information from the crew to determine the type of weather and sea conditions the ship was experiencing. Shore staff made trips on the vessel and video tapes of severe weather conditions were made, so that the

engineering team had a clear picture of the type of environment, which was probably causing the cracks.

2. A history of the number and locations of the fractures was compiled using data from the ship's crew, repair contractors, testing contractors and direct physical inspection. The owner and the engineering firm (MCA Engineers) reviewed that history together along with voyage and weather data to comb out any patterns in the number or location of fractures. As has been stated earlier in the paper, this process led directly to decisions in modeling, analysis, and repair development, that were essential to the success of the final repairs.
3. At every step of the analysis process, there was extensive planned interaction between the engineering contractor and the owner concerning details of the structural model, the load cases to be analyzed, the results of the computer output, the diagnosis of the causes of the fracture and, most particularly, in development of the reinforcement design and testing. A validation analysis was done on every proposed method of repair, and the repair design was tuned and refined by extensive repetitions of the analysis. Some repair models were redesigned and tested each day for weeks before being accepted with each change in design growing out of debates between the owner and the engineering contractor. Even the acceptance criteria and the allowable levels of stress in the repair model were subject to continual review and change.
4. The success of the renovation project required the full commitment of the owner in a belief that the analysis process would achieve a satisfactory result, and that sufficient funding would be provided to see the project through to a conclusion. In the case of the S/S CORNUCOPIA, this process has carried on over a period of 10 years and consumed millions of dollars in the renovations themselves as well as the analysis.
5. Considering the history of the S/S CORNUCOPIA and other vessels with chronic structural problems, one can never be certain that the problems are completely solved and that there won't be some new cases in the future caused by the elimination of those in the past. Certainly, the CORNUCOPIA's structure has been subject to fatigue as well as over stress, and we anticipate some fracture problems in the future. To resolve these problems efficiently requires early detection and application of the techniques, which have proved so effective over the life of the ship. Therefore, we plan to continue the process of periodic inspection to confirm the performance of the completed modifications and detect any new failures which might arise. But detection, analysis and

repair are not wholly adequate in themselves, we must also consider possibilities for prevention.

## Techniques for Prevention

As the process of structural renovation of the S/S CORNUCOPIA was proceeding, it often occurred to us that, beyond creating a sound structure, there ought to be actions that could be taken to reduce the loads that the ship structure experiences in service. Since we have certain target areas where fractures frequently occur and recur, we know precisely where the most vulnerable parts of the vessel's structure are. In 1986, a project was proposed to instrument the vessel with load-sensing transducers directly attached to structure, which had experienced the most frequent fractures. These sensors would be connected to a computer mounted in the wheel house. The computer software would be designed to receive sensor output, analyze it, and provide a simple relative indicator as a graph on the CRT for the Master to obtain an indication of the severity of the load on critical vessel's structure. In severe weather, the Master could consult the hull sensor data to determine unambiguously if changes in course or speed were having a salutary or negative effect upon the structure. By providing multiple sensors and several channels of data, the result would be clearly indicative of the performance of the ship. The next step would be to store large quantities of the data at high speed in a mass storage device for later correlation with structural models by engineers ashore. After considerable research by MCA Engineers, an array of hardware has been identified, which should be capable of achieving these goals. In September of 1990, a project was approved to build a structural response monitoring system. This system is currently under construction and will be installed later this year or early in 1992.

The structural monitoring planned for the CORNUCOPIA is under development and is not yet fully defined, but the following description incorporates the equipment and functions that are most likely to be included in the system.

The understanding of the ship's dynamic response to the real environmental load is crucial to structural design and repair of damaged structure. Normally, stress data is used indirectly to correlate the ship movements with the measured wave motion. Since the critical locations, in terms of stress, are identified through Finite Element Analysis (and other assumptions), a monitoring system can be applied to the ship to record the response of the structure at these important positions and analyze the stress data and use it immediately for the operation of the ship.

The purpose of this Structural Monitoring System (SMS) is to serve as a means of real-time display of the response of the ship to the waves motions so appropriate actions can be taken to operate the ship. Also the history of the response can be

viewed in a trend display to measure the effectiveness of the corrective actions taken. A high density tape drive would be used to record the response of the structure and the data could be played back for future study and research.

The SMS is expected to consist of the following major components: (See Figure 65.)

- Sensors
- Signal Conditioners
- Analog to Digital Converter
- Host Computer (PC and monitor)
- High capacity storage

There are two different types of sensors which will be installed on the ship:

- Strain Gauges
- Accelerometers

Strain gauges will be installed on the under deck as longitudinal stiffeners. On the deck, strain gauges will be used to measure hull girder longitudinal strain at three longitudinal locations to port and starboard along the deck and immediately above the hold space. Gauges are to be protected against mechanical and environmental damage.

Near amidships, on the upper deck, a three-dimensional accelerometer will be installed to measure the three primary motions of the vessel (heave, surge and sway). The data will be used to correlate the wave conditions with the structural performance of the ship. An additional accelerometer will be mounted in the forward bosun's store for monitoring the vertical motion of the bow.

The voltage signals from the sensors described above will be amplified, filtered and converted to the form of constant current suitable for long distance transmission. The signal conversion unit is required for each of the sensors and is to be placed very close to the sensor itself. Either it will be provided as a built-in unit with the sensor or it will be separately manufactured and connected to the sensor. Constant current sources are needed for the long distance transmission of data because the level of voltage-type signals will drop rapidly as the distance becomes longer, whereas in the current form, the value of the current will be maintained the same from the source (sensors) to the destination (host computer) which are several hundred feet apart.

A very high-speed A/D converter with the capability of Direct Memory Access (DMA) operation will be utilized to ensure that the maximum speed of the sampling rates will be handled successfully. The advantage of the DMA operation is that it



can provide the means to read or write data at precise times without significantly restricting the microcomputer's task. DMA is also the only way to make the goal of high-speed foreground/background operation possible. (See Figure 65.)

An industrial-grade 486 PC will be used as the host computer to control the operation of this SMS. This host computer will be equipped with Video Graphic Adapter (VGA) color monitor, keyboard, and high density floppy disk drive. A very high capacity hard drive will also be installed with the computer for data storage which will be used for trend display of the response of the ship to the waves motions.

A high density tape drive will be used to facilitate the data recording operation for a long period of time. These data will be played back and the actual vessel performance will be studied and the comparison to the theoretical predictions of structural performance will be made.

Data from the vessel's navigation instruments, such as gyro pilot, GPS and speed indicators, will input to the system such that the recorded data will include the vessel's location, RPM, and heading.

Responses of the structure to the waves motions are picked up at the sensors in the form of electrical signals. These raw signals then go through the signal conditioning circuits where amplification and filtering will be applied. The operation of conversion from voltage to current is needed to prepare for the long distance transmission. At the other end of the transmission line where the host computer is located, the current value in the current loop is again converted back to voltage by the means of a 250 ohm load. The resulting signals will then be routed to the A/D converter which is installed in the host computer. The A/D converter will digitize the signal according to the predetermined sampling rates. Data will then be real-time displayed on the screen of the computer and, at the same time, written onto the hard drive for future use in the trend display operation. (See Figure 66.)

The responses at the sensors are displayed in groups of bar charts representing the same type of sensors. At any moment, one particular group can be selected to display on the screen (See Figure 66). The history of the responses of any single sensor can be viewed by trend display at the lower portion of the screen (See Figure 66). Different intervals of time for the trend display can also be selected manually.

Signals from the sensors will also be recorded on the Exabyte tape drive, or similar high density recording device. The recording rates are to be changed according to the preset levels. These will be done through software automatically.

The present levels are as follows:

- Idle: At low sea states, i.e., in harbor.
- Low: Moderate ship activities.
- High: At high sea states, when peak responses are recorded.

The sampling rates can be summarized in the following table:

Sampling Rates - Samples per second			
	IDLE	LOW	HIGH
STRAIN	0	5	50
MOTIONS	0	5	50

## List of Figures

<u>Figure No.</u>	<u>Title</u>
1.	Plan View Main Deck and Second Deck
2.	Plan View Flats and Tank Top
3.	Compartment Arrangement
4.	Inboard Profile
5.	Midship Section Ordinary and Web Frames
6.	Midship Section Ordinary Frame
7.	Midship Section Web Frame
8.	Tank Supports, Pitch Keys and Roll Keys
9.	Tank Supports and Keys
10.	Cargo Tank Arrangement
11.	Typical Fractures 1982
12.	S.S. CORNUCOPIA Profile
13.	Wave Profile for Load Case 6
14.	Boundary Forces for Load Case 6
15.	Tank Support Forces for Load Case 6
16.	Web Frame Model Tank Top Plating
17.	Web Frame Model Inner Bottom Substructure
18.	Web Frame Model Saddle Ballast Tank
19.	Typical Assembled Model of Web Frame
20.	Assembly of Frames into Global Model
21.	Fine Mesh Model of Typical Web Frame
22.	Web frame at Inner Bottom
23.	Plan View Lower Tank Top Knuckle
24.	Plan View Lower Tank Top Knuckle
25.	Ordinary Frame Saddle Tank

<u>Figure No.</u>	<u>Title</u>
26.	Plan View Saddle Tank Bottom Plating
27.	Test Results Lower Tank Top Knuckle Repair Bracket
28.	Test Results Lower Tank Top Knuckle Repair Bracket
29.	Web Frame Tank Top Transition
30.	Repair Bracket at Ordinary Frame
31.	Repair Structure at Saddle Tank
32.	Saddle Tank Reinforcing Bracket
33.	Saddle Tank Reinforcement Bracket
34.	Inner Bottom Knuckle Reinforcement
35.	Inner Bottom Knuckle Reinforcement
36.	Inner Bottom Knuckle vent Closing Plate
37.	Typical Fractures No. 3 Hold Upper Deck
38.	Global Model
39.	Deck Model
40.	Corner Model
41.	Beam Stresses for Run #0558913
42.	Upper Deck 1/2 Plan Before Repair
43.	Plan Upper Deck corner
44.	Plan Upper Deck Corner
45.	Upper Deck Plan After Repair
46.	Plan Upper Deck Corner
47.	Upper Deck Girder After Repair
48.	Upper Deck Stress Analysis
49.	Typical Under Deck Diagonal Repair Girders
50.	Plan View - Upper Deck Without Reinforcement
51.	Plan View - Upper Deck After Reinforcement

<u>Figure No.</u>	<u>Title</u>
52.	View of Underside of Upper Deck Prior to Reinforcement
53.	View of Underside of Upper Deck After Reinforcement 40" Girders
54.	View of Top - Upper Deck After Reinforcement 40" Girders
55.	View of Top - Upper Deck After Reinforcement 24" Girders
56.	Top View of Upper Deck Prior to Reinforcement
57.	Top View of Upper Deck After Reinforcement 24" Girders
58.	View of Underside of Upper Deck Prior to Reinforcement
59.	View of Underside of Upper Deck After Reinforcement 24" Girders
60.	View of Underside of Upper Deck Prior to Reinforcement
61.	View of Underside of Upper Deck After Reinforcement
62.	Upper Deck Reinforcement
63.	New Repair Girder 24" Web 12" Flg.
64.	Transverse Repair Girders
65.	Sensor Configuration
66.	Display on the VGA Monitor

List of Tables

<u>Table No.</u>	<u>Title</u>
1.	Hull Fracture Data
2.	Saddle Tank Hull Stress Data
3.	Inner Bottom Hull Stress Data

## BIBLIOGRAPHY

- American Bureau of Shipping, "Structural Analysis of a 32000 M<sup>3</sup> Ammonia/Propane Carrier, Final Report RD-75019, November 1975.
- Cheung, Dr. Maxwell C., "Structural Analysis of S.S. CORNUCOPIA", Volume I and II, January 19, 1983.
- Designers and Planners Inc. "S/S CORNUCOPIA Web Frame Analysis", May 1980.
- Designers and Planners Inc., "Structural Analysis of S/S CORNUCOPIA Double Bottom Fractures", Report No. 8157001, January 20, 1982.
- Designers and Planners Inc., "Preliminary Analysis of S/S CORNUCOPIA Upper Wing Tank Fractures", Report No. 8157002-A, March 25, 1982.
- MCA Engineers Inc., "Repair Analysis of S/S CORNUCOPIA", Final Report, Volume I, II and III, June 20, 1983.
- MCA Engineers Inc., "Structural Analysis of S.S. CORNUCOPIA", Final Report, September 28, 1988.
- MCA Engineers Inc., "S/S CORNUCOPIA Deck Structural Reinforcement", P8948-WCS, March 20, 1989.
- MCA Engineers Inc., "S/S CORNUCOPIA #3 Tank Deck Structure", Final Report, May 16, 1989.
- Mitsubishi Heavy Industries Ltd., "Report of Inspection", October 23, 1983.
- Mitsubishi Heavy Industries Ltd., "Fatigue Strength Test for the Intersection of the Inner Bottom and the Hopper Tank Top", Mitsubishi Technical Bulletin No. 78, July 1972.
- Pittsburg Testing Laboratory, "Magnetic Particle Inspection Report", July 28, 1983.
- Raynaud, J. and B. Javelle, "Structural Problems in Methane Carriers", Ship Repair and World Ship-builder, May 1975, P.55-82.

NOT TO SCALE  
PLAN VIEW

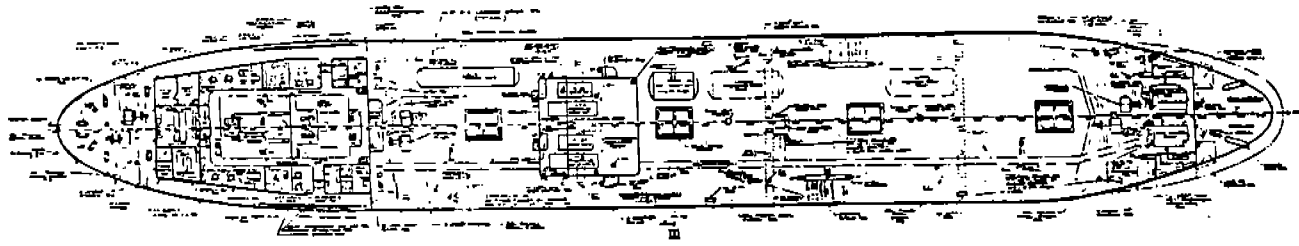

S. S. CORNUCOPIA

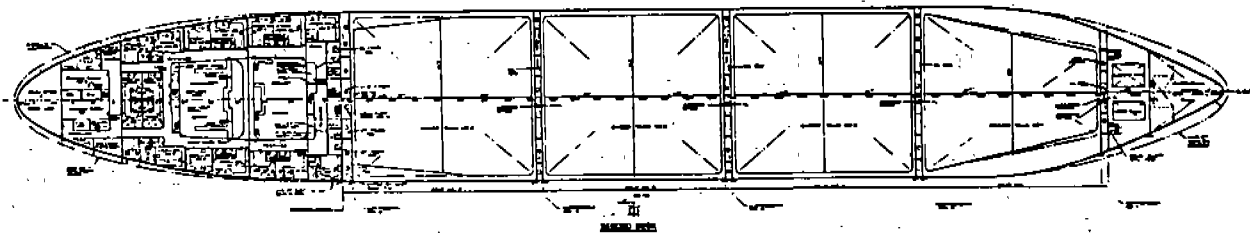

PLAN VIEW MAIN DECK AND SECOND DECK  
FIG. 1

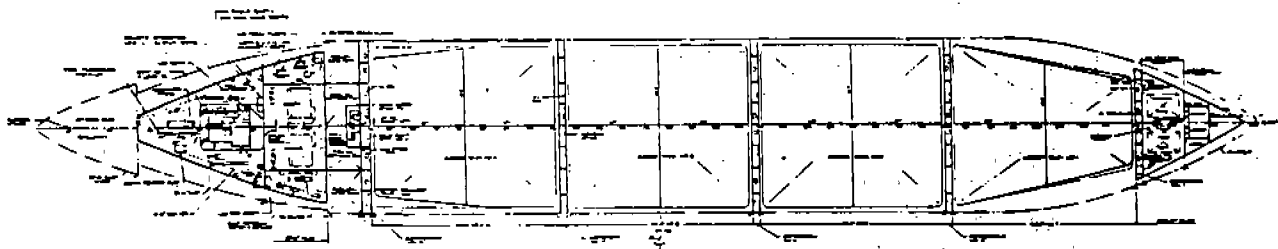

S. S. CORNUCOPIA

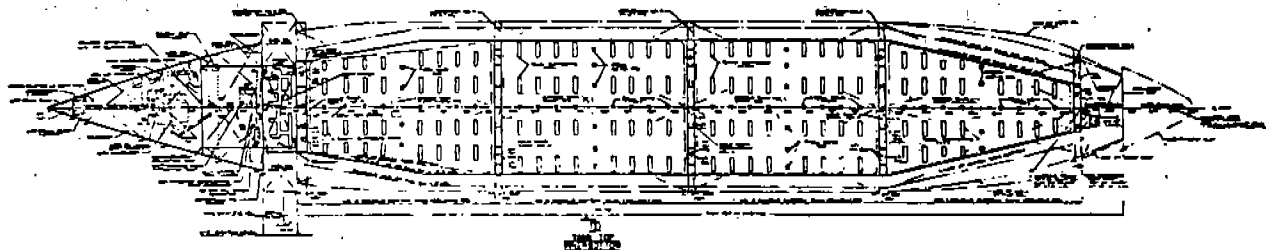

PLAN VIEW FLATS AND TANK TOP  
FIG. 2





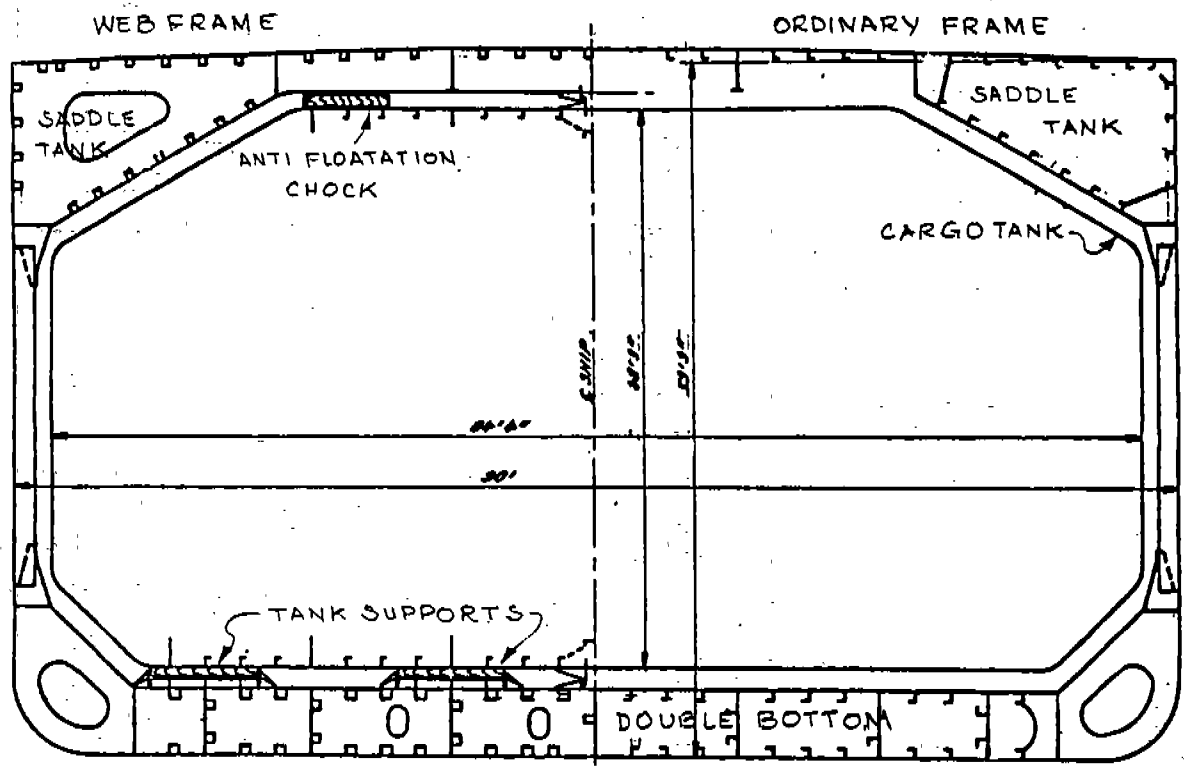

MIDSHIPS SECTION FIG. 5

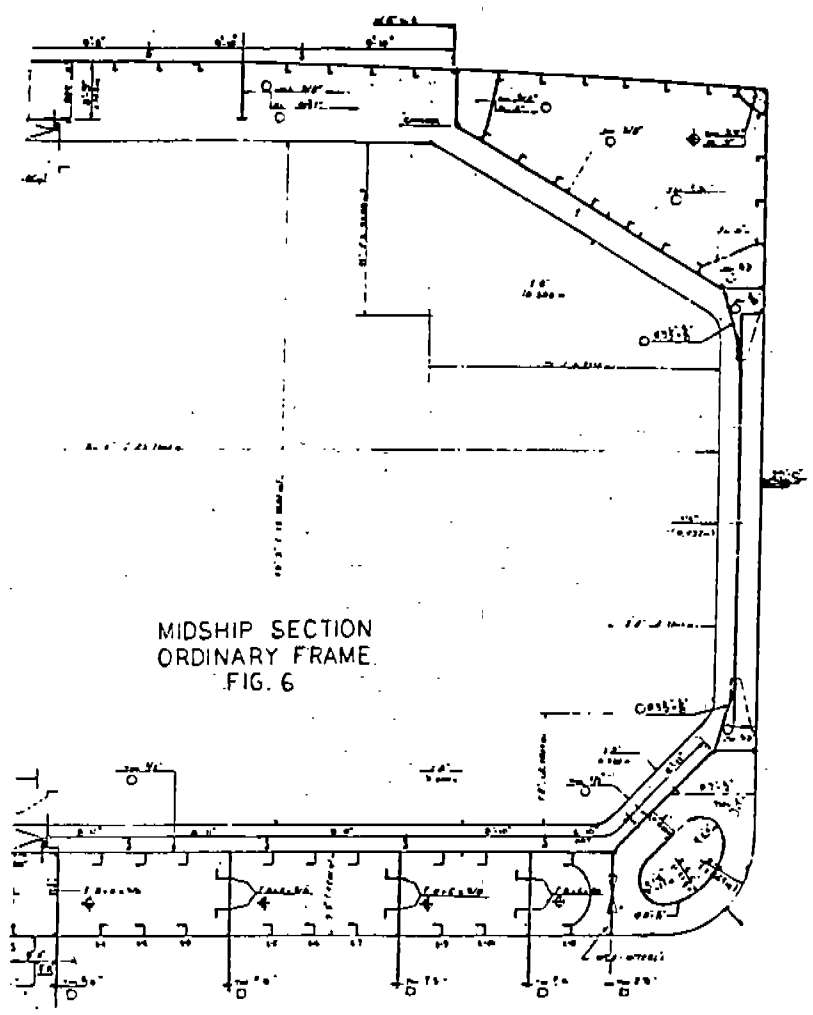

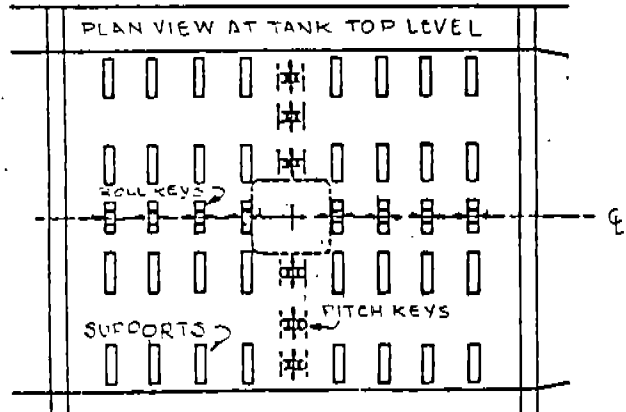
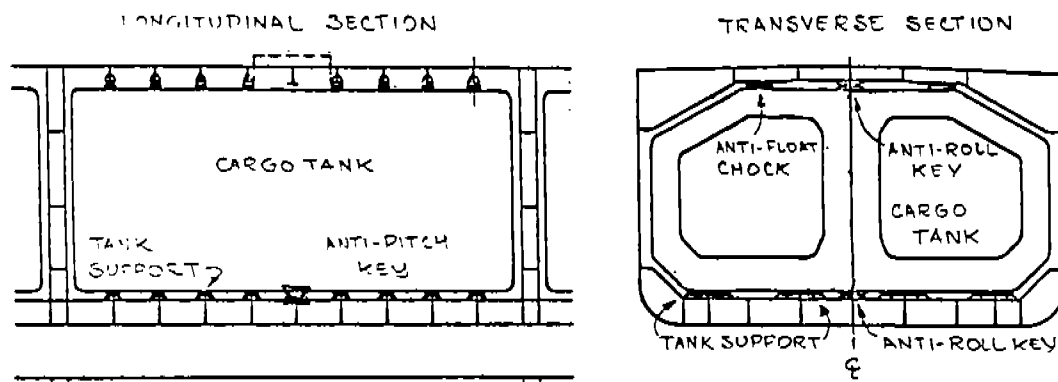
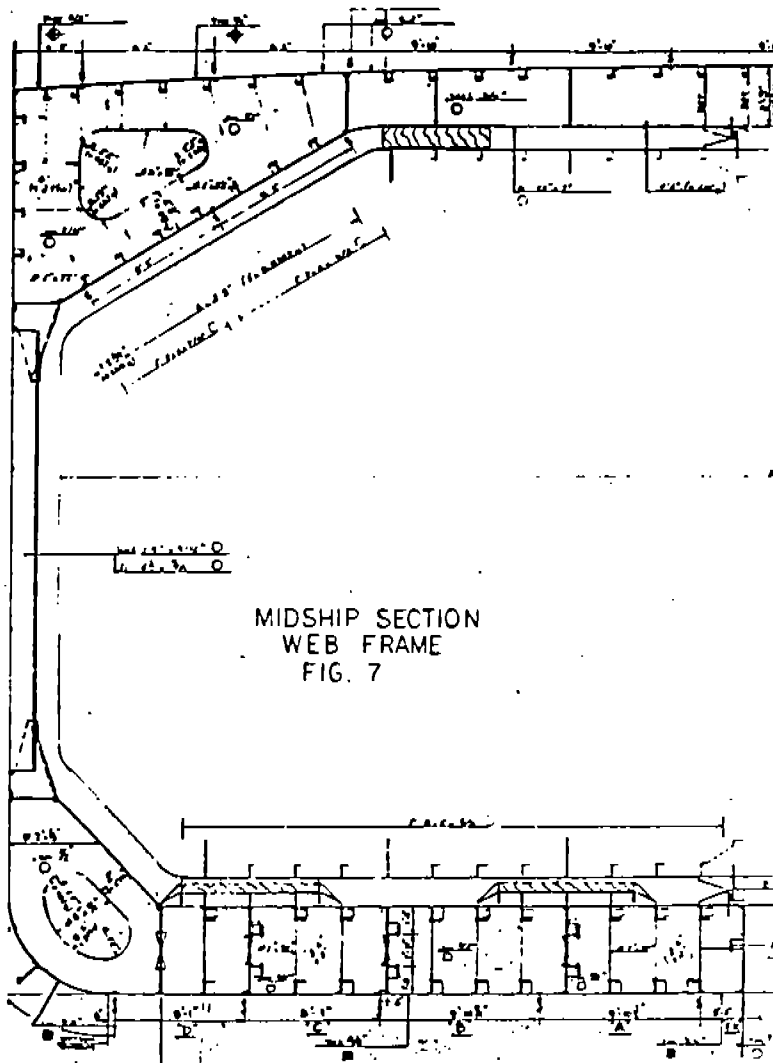

TANK SUPPORTS, PITCH KEYS AND ROLL KEYS  
FIG. 8

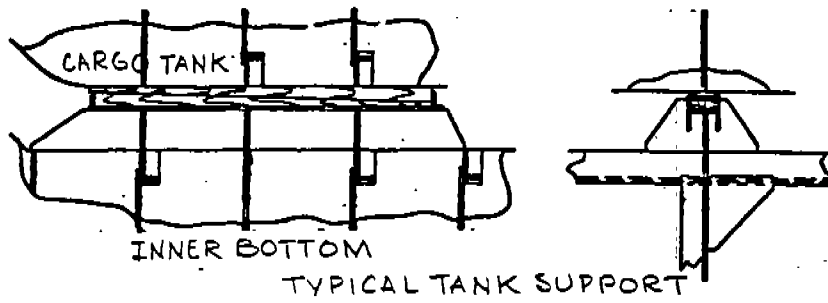

INNER BOTTOM  
TYPICAL TANK SUPPORT

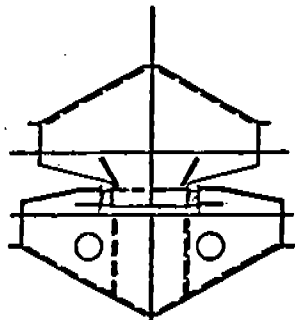

TYPICAL ANTI-PITCH OR  
ANTI-ROLL KEY

TANK SUPPORTS  
AND KEYS  
FIG. 9

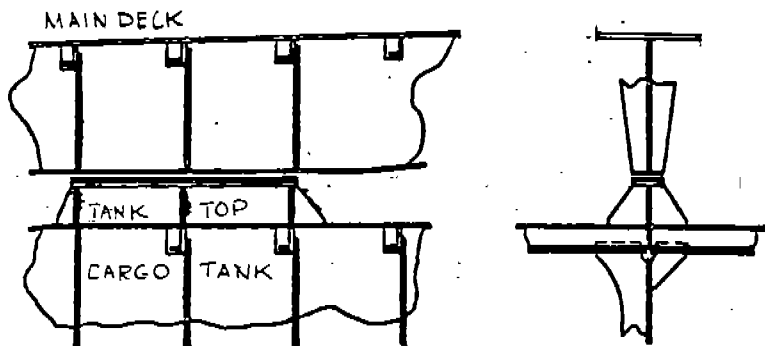

ANTI-FLOATATION CHOCK

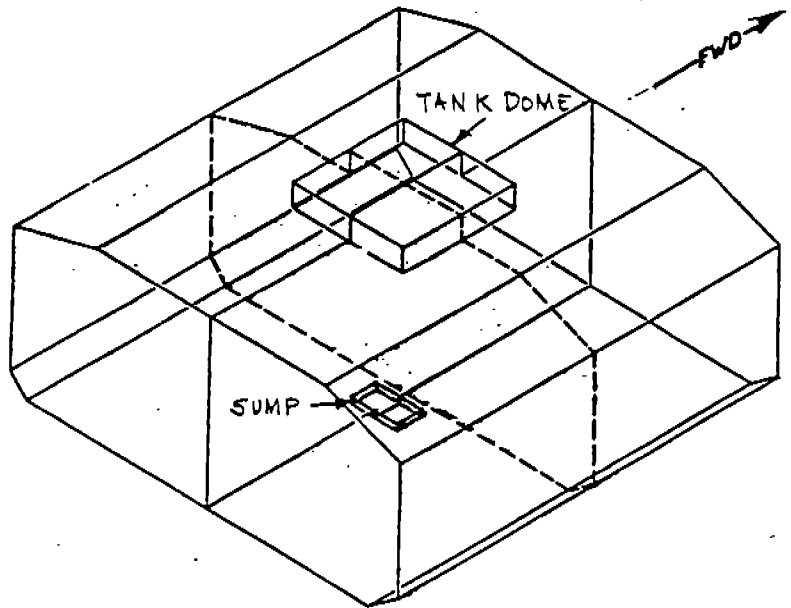

CARGO TANK ARRANGEMENT

FIG. 10

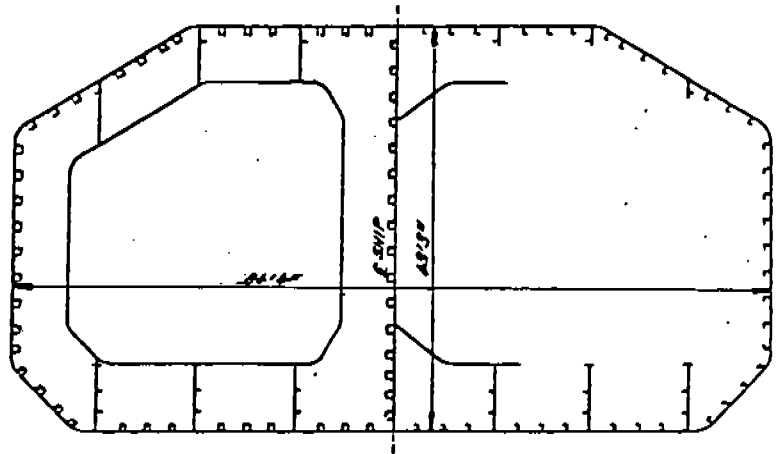

CARGO TANK SECTION

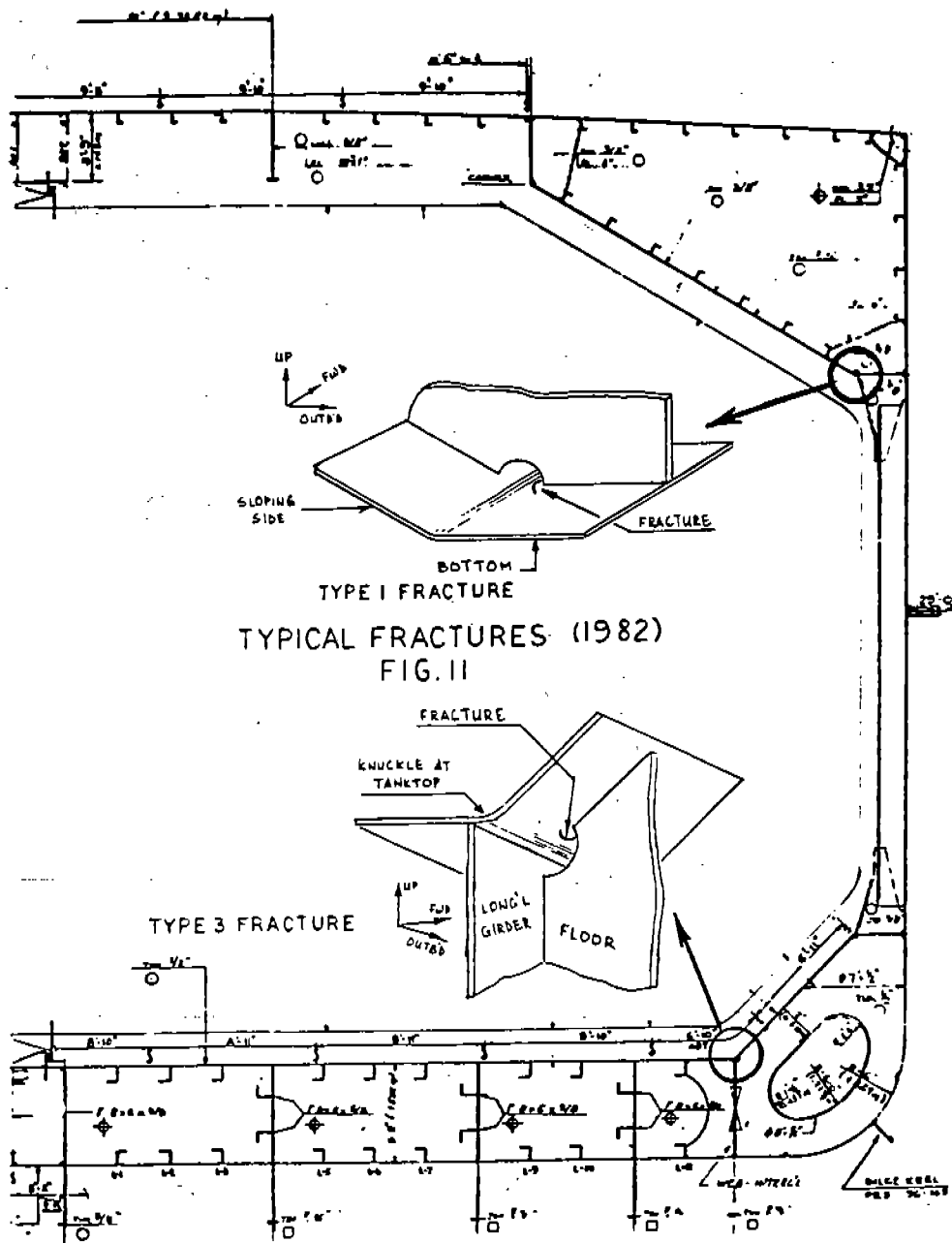

TYPICAL FRACTURES (1982)  
 FIG. II

S/S CORNUCOPIA  
HULL FRACTURE DATA

TABLE 1

TANK	FRACTURE TYPE							TOTAL
	1	2	3	4A	5	6	7	
1 PORT	2	1	16	1	12	0	0	32
1 STBD	6	1	18	3	10	2	0	40
2 PORT	0	0	16	21	4	1	0	42
2 STBD	0	2	15	15	4	0	1	37
3 PORT	7	2	19	22	7	0	3	60
3 STBD	8	0	15	37	6	4	0	70
4 PORT	3	14	11	26	35	1	0	90
4 STBD	3	3	9	31	27	0	5	78
TOTALS:	29	23	119	156	105	8	9	449
PORT:	12	17	62	70	58	2	3	224
STDB:	17	6	57	86	47	6	6	225

01-Oct-91

S/S CORNUCOPIA  
HULL STRESS DATA  
SADDLE TANK TABLE 2

VALUES ARE MAXIMUM STRESS IN KSI

LOAD CASE	FRAME TYPE	FRAME LOCATN	BOTTOM PLATE	TRANSVERSE GUSSET		SIDE SHELL
				UPPER	LOWER	
6	WEB	1/4L	15	35	36	8
6	WEB	1/2L	15	35	35	8
6	WEB	3/4L	19	35	35	11
6	ORD	1/2L	25	37	23	19
1A	WEB	1/4L	14	20	44	-
4A	ORD	1/2L	33	62	40	-

INNER BOTTOM KNUCKEL TABLE 3

VALUES ARE MAXIMUM STRESS IN KSI

LOAD CASE	FRAME TYPE	FRAME LOCATN	INNER BOTTOM	TRANSVERSE FLOOR		LONG. GIRDER
				OUTBOARD	INBOARD	
6	WEB	1/4L	59	60	35	29
6	WEB	1/2L	66	69	42	34
6	WEB	3/4L	58	57	34	28
6	ORD	1/2L	53	50	30	26

ALL VALUES ARE PRIOR TO RPAIR

01-Oct-91

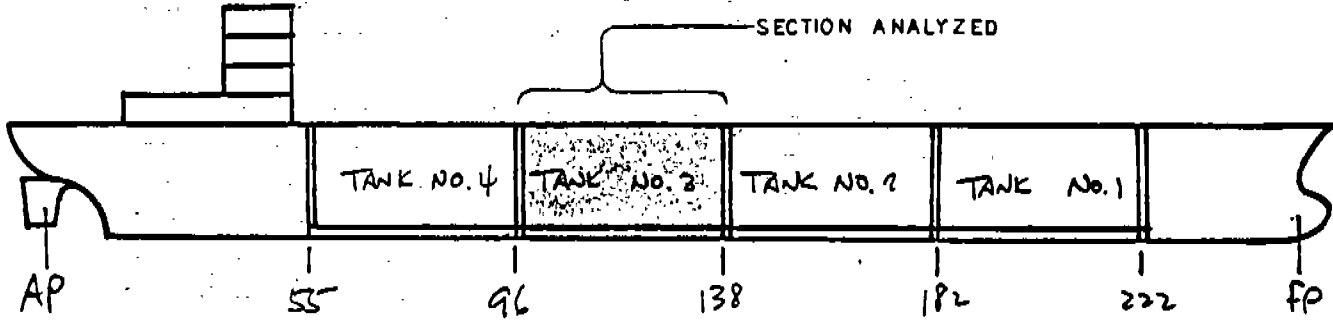

S. S. CORNUCOPIA PROFILE  
FIG. 12

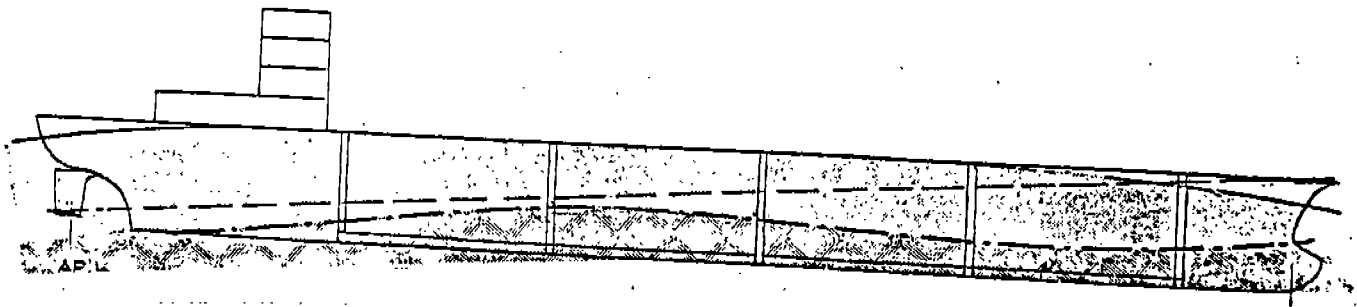

Load Case 6 - Dynamic Full Load Condition  
Maximum Roll Angle

— Port Side Wave Profile  
- - - Stbd Side Wave Profile

Wave Height . . . . .	50' - 10"
Wave Length . . . . .	561' - 6"
Crest from A.P. . . . .	130' - 0"
Wave Heading (off port bow) . . . . .	60°
Pitch Angle . . . . .	-4.45°
Heel Angle (to port) . . . . .	32°

Wave Profile for Load Case 6  
FIG. 13



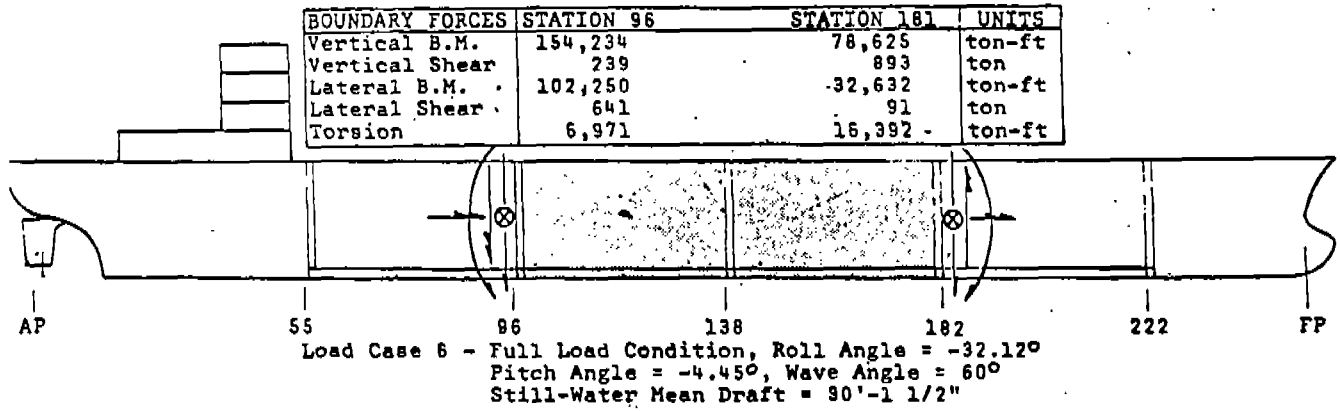

Boundary Forces for Load Case 6

FIG. 14

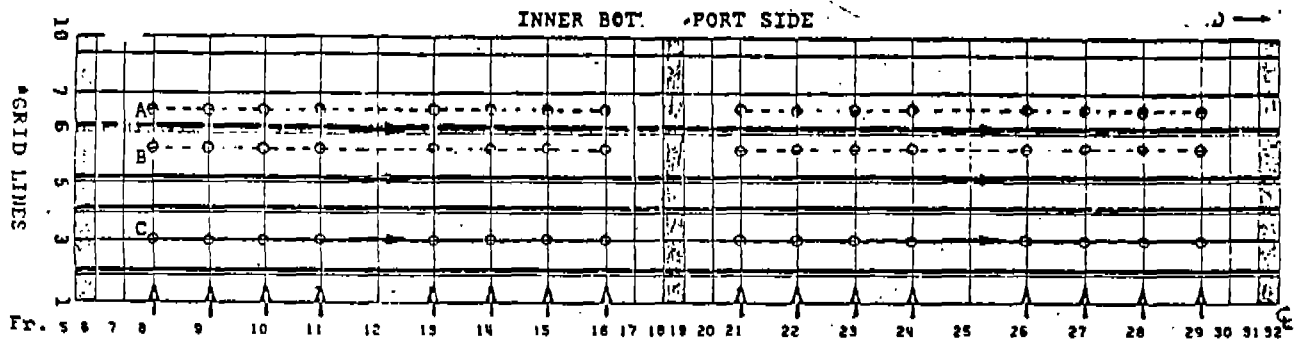

TANK SUPPORTS - AXIAL FORCES (KIPS)

A	511	261	262	386	390	272	274	559	516	279	281	409	400	267	241	433
B	337	147	169	269	271	169	138	334	329	141	161	259	260	164	127	262
C	593	403	421	581	569	413	392	609	577	385	397	541	525	380	348	484

ROLL KEYS - SHEAR FORCES (KIPS)

1	187	229	273	325	329	284	256	239	278	275	294	339	341	296	273	266
---	-----	-----	-----	-----	-----	-----	-----	-----	-----	-----	-----	-----	-----	-----	-----	-----

PITCH KEYS - SHEAR FORCES (KIPS)

6	223	*GRID LINES	175
5	229	1 - Centerline	152
3	258	3 - Girder 11'-0" off Centerline	130
		5 - Girder 22'-0" off Centerline	
		6 - Girder 30'-3" off Centerline	
		7 - Girder 35'-9" off Centerline	
		10 - Side Shell	

Tank Support Forces for Load Case 6

FIG. 15

03 PREPT -IMP-

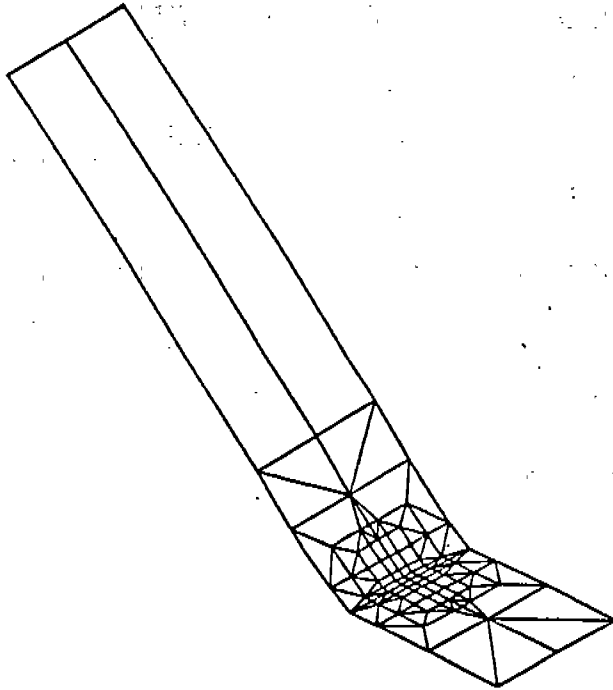

XU=1  
YU=1  
ZU=1

WEB FRAME MODEL  
TANK TOP PLATING  
FIG. 16

WEB FRAME LEFT SIDE ONLY

EPLY ANSYS 14

12 PREPT -IMP-

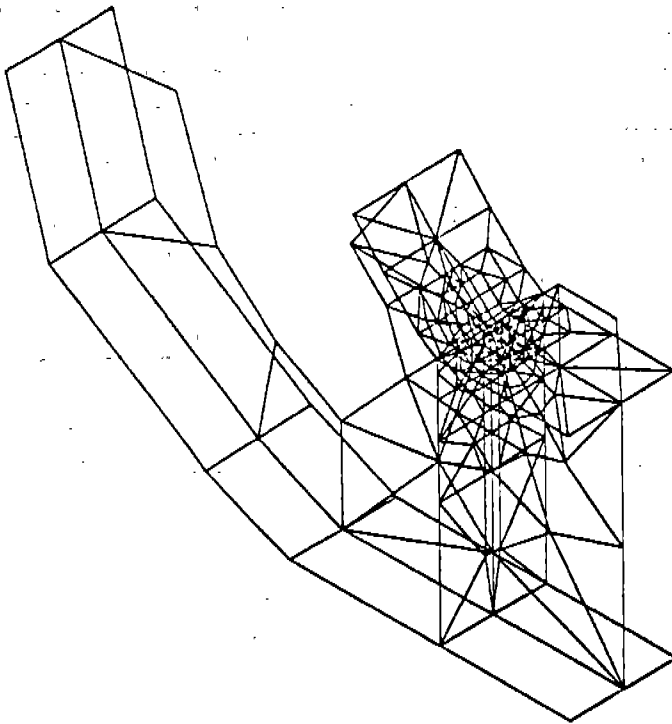

XV=1  
YV=1  
ZV=1  
XMIN=-540  
XMAX=-300  
YMAX=85

WEB FRAME MODEL  
INNER BOTTOM  
SUBSTRUCTURE  
FIG. 17

WEB FRAME LEFT SIDE ONLY

EPLY ANSYS 7

26 PREP7 -INP-  
 ELIST,67,68  
 LIST,ELEM 67 TO 68 BY 1

11/8/82 28.840 E

ELEM	MAT	TYPE	REL	CLS	NOES			
67	17	1	17	8	667	268	269	668
68	17	1	17	8	668	269	270	669
69	24	1	24	8	268	609	601	269

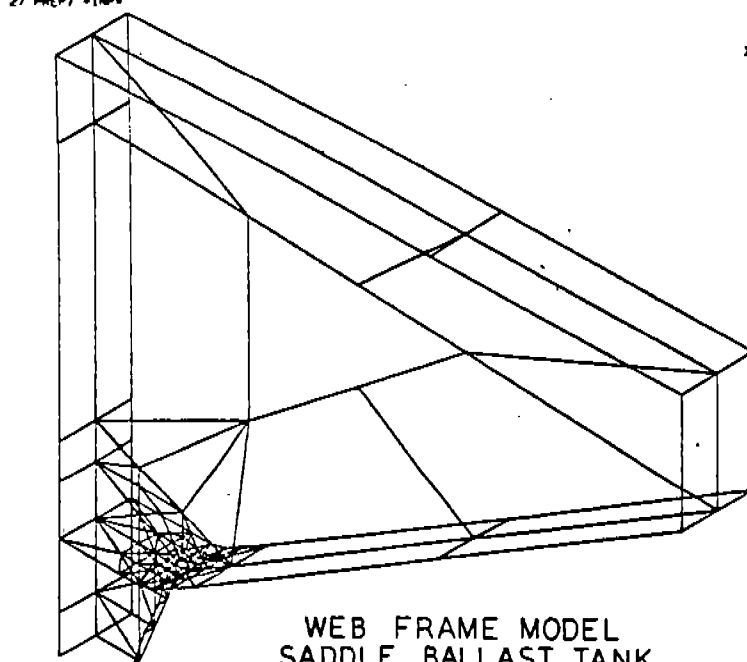

XV=1  
 YV=1  
 ZV=1  
 XMIN=-648  
 XMAX=208  
 YMIN=488  
 YMAX=788

WEB FRAME MODEL  
 SADDLE BALLAST TANK  
 FIG. 18

WEB FRAME LEFT SIDE ONLY

EPLT ANSYS 14

6 PREP7 -INP-

10/28/821.007 E

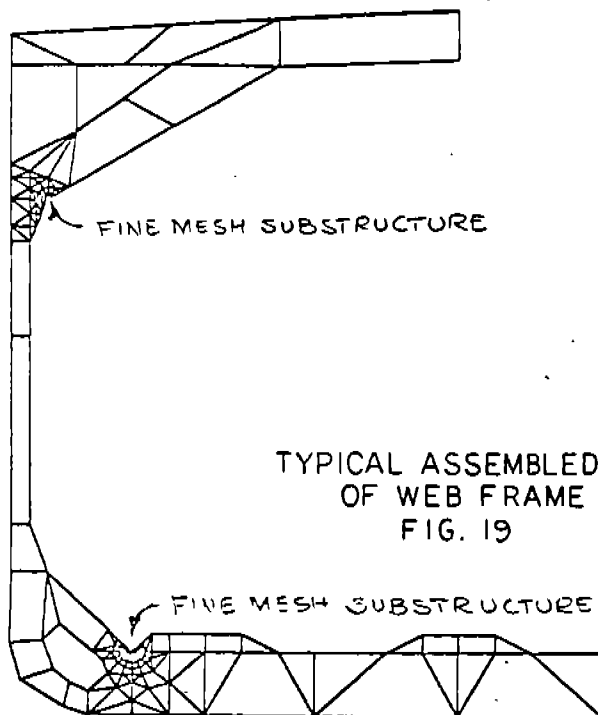

Y  
 X

ZU=1  
 ZMIN=-.1  
 ZMAX=.1

TYPICAL ASSEMBLED MODEL  
 OF WEB FRAME  
 FIG. 19

WEB FRAME LEFT SIDE ONLY

EPLTANSYS 1

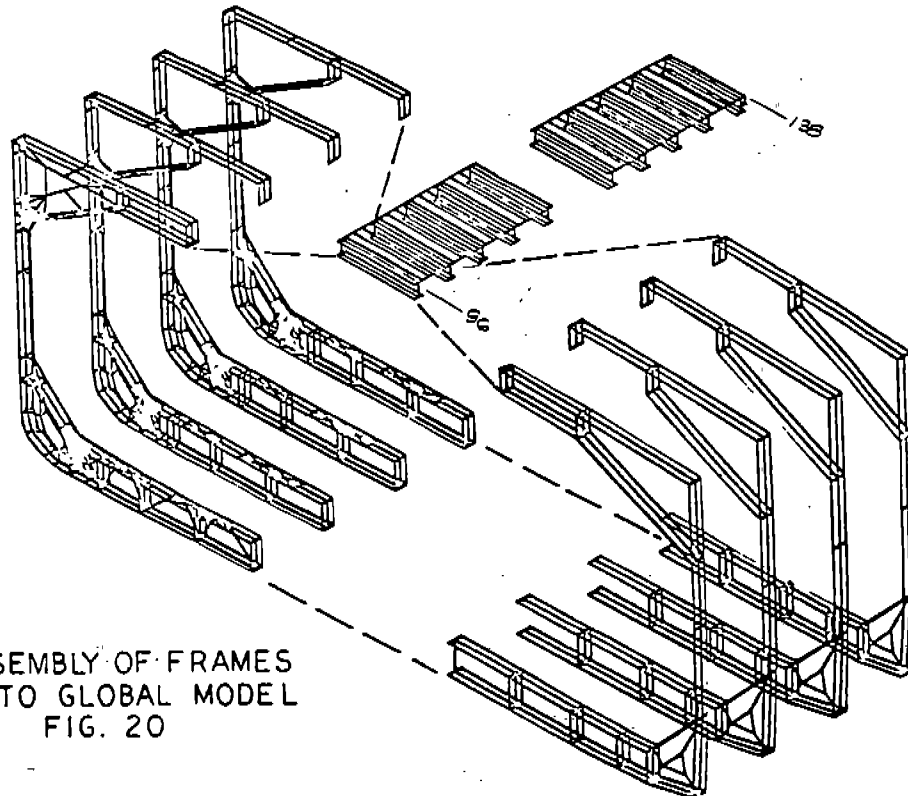

ASSEMBLY OF FRAMES  
INTO GLOBAL MODEL  
FIG. 20

10/22/88 21.100 K

10 PREP7 -IMP-

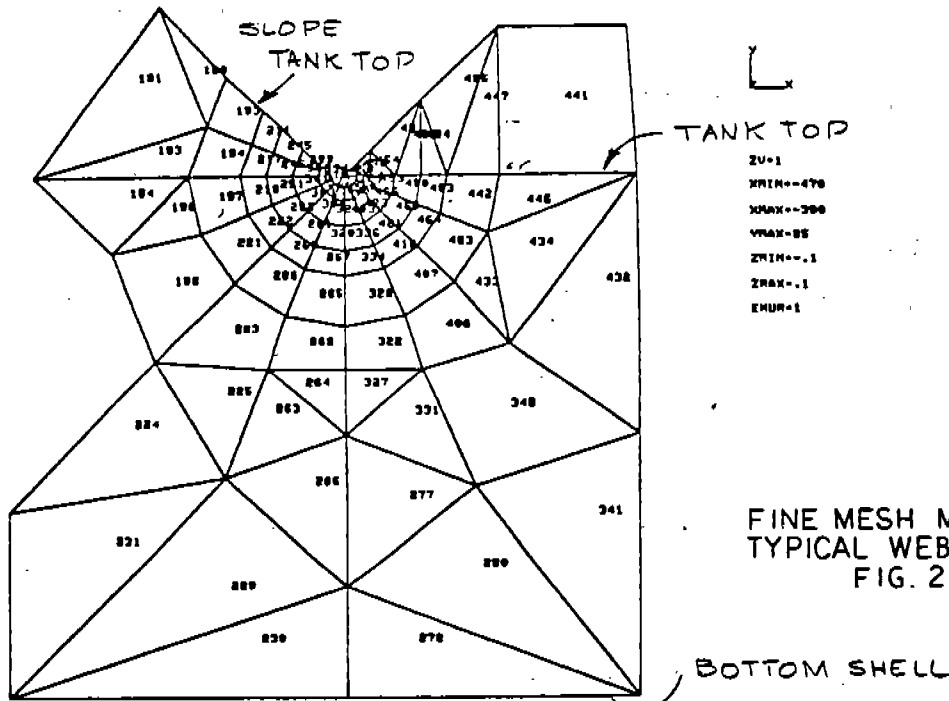

WEB FRAME LEFT SIDE ONLY

EPLY ANSYS 4

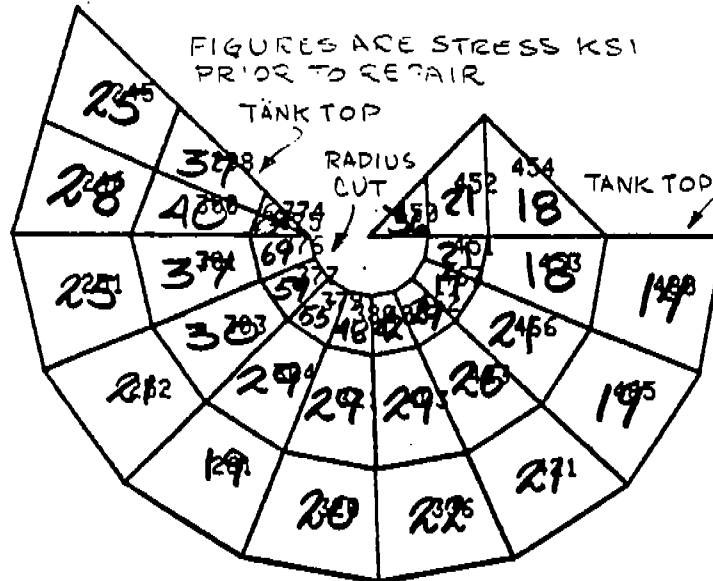

ZU=1  
XMIN=-439  
XMAX=-420  
YMIN=53  
YMAX=72  
ZMIN=-1  
ZMAX=1  
ENUM=1

WEB FRAME AT  
INNER BOTTOM  
FIG. 22

WEB FRAME LEFT SIDE ONLY

EPLTANSYS 20

BY PREP7 -INP

10/20/88 01.410 C

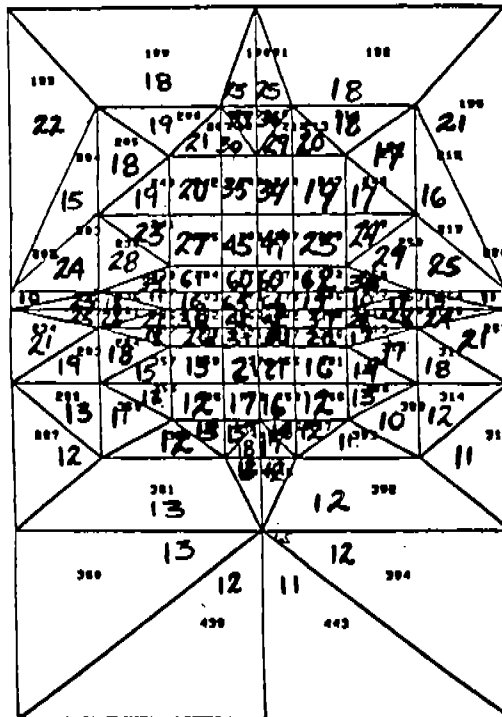

ZU=1  
YU=1  
ENIN=183  
ENAX=10000  
ENUP=1

— KNUCKLE

PLAN VIEW LOWER TANK  
TOP KNUCKLE  
VALUES ARE STRESS KSI  
BEFOR REPAIR  
FIG. 23

WEB FRAME LEFT SIDE ONLY

EPLT ANSYS 10

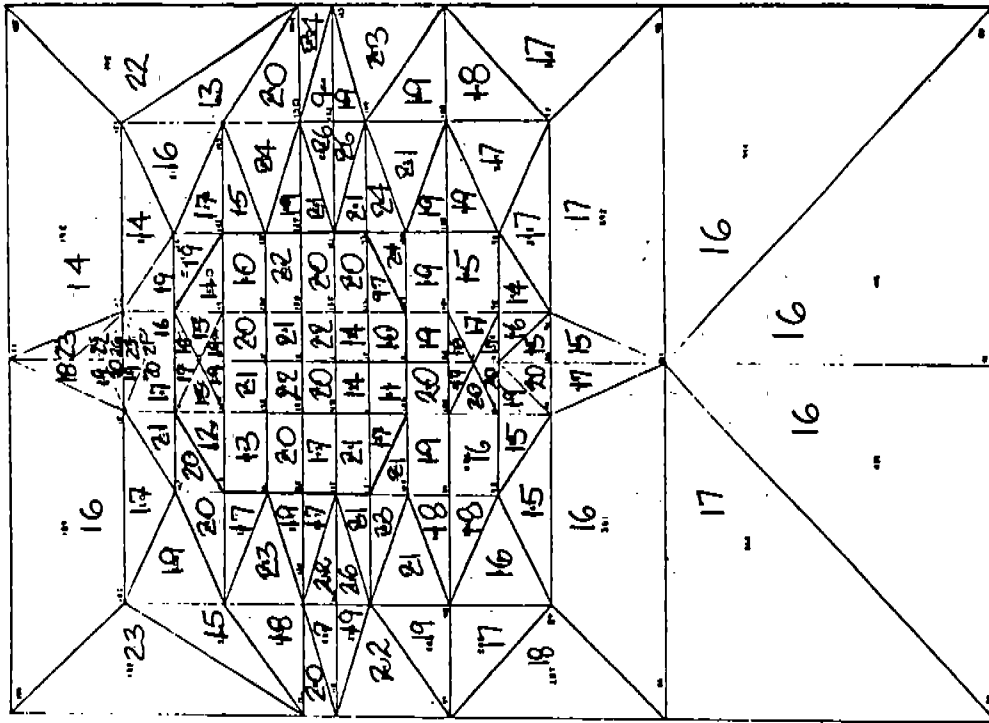

PLAN VIEW LOWER TANK TOP KNUCKLE  
 VALUES ARE STRESS AFTER REPAIR  
 FIG. 24

30 PREP7 -INP.

3/29/83 17.950 E



ZU=1  
 XMIN=-541  
 XMAX=300  
 YMIN=486  
 YMAX=530  
 ZMIN=-1  
 ZMAX=1  
 ENUM=1

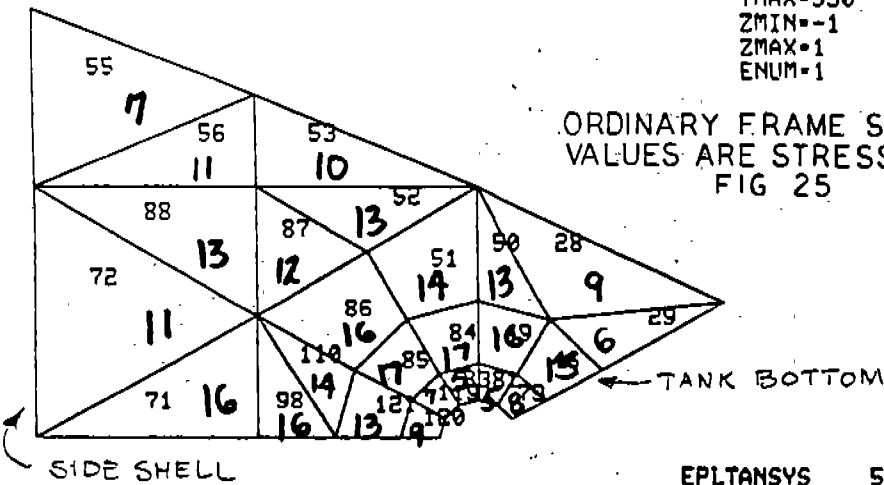

ORDINARY FRAME SADDLE TANK  
 VALUES ARE STRESS IN KSI  
 FIG 25

EPLTANSYS 5

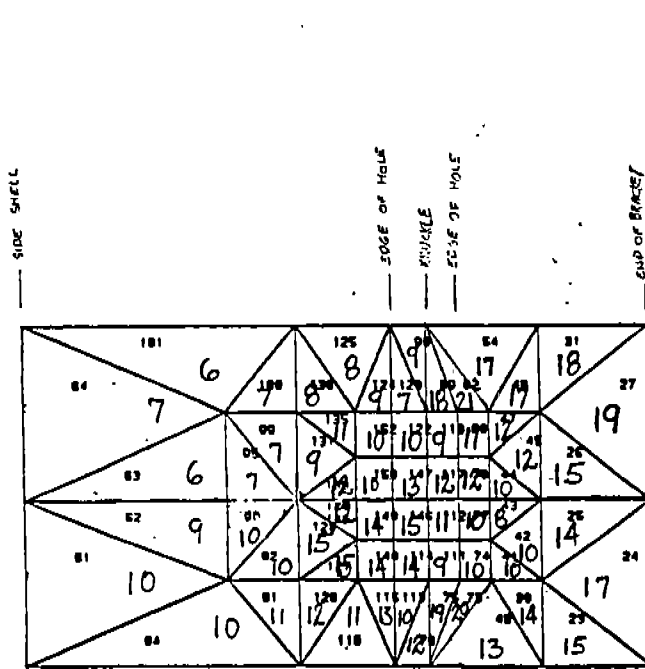

TV=1  
 ENIN=23  
 ENAX=102  
 ENAP=1

PLAN VIEW SADDLE TANK  
 BOTTOM PLATING  
 VALUE ARE STRESS KSI  
 AFTER REPAIR  
 FIG. 26

EPLT ANSYS 10

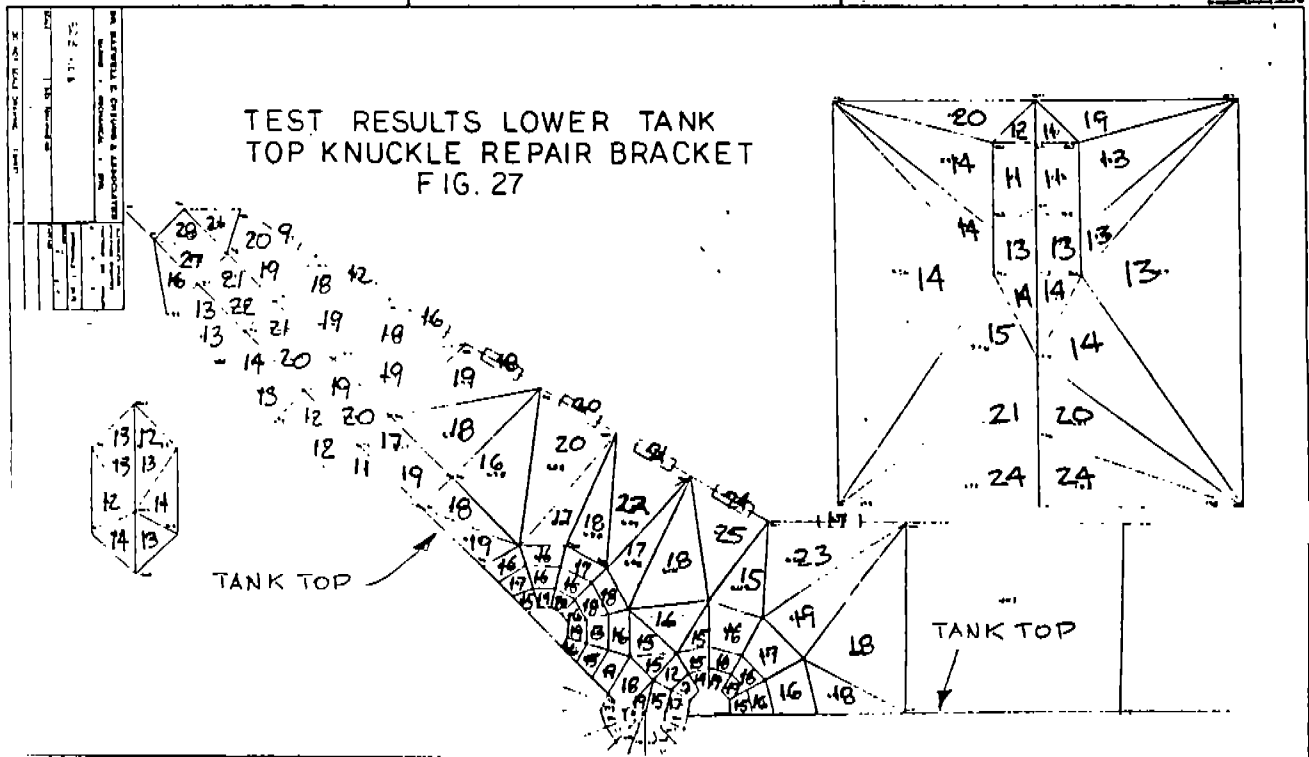

TEST RESULTS LOWER TANK TOP KNUCKLE  
REPAIR BRACKET

FIG. 28

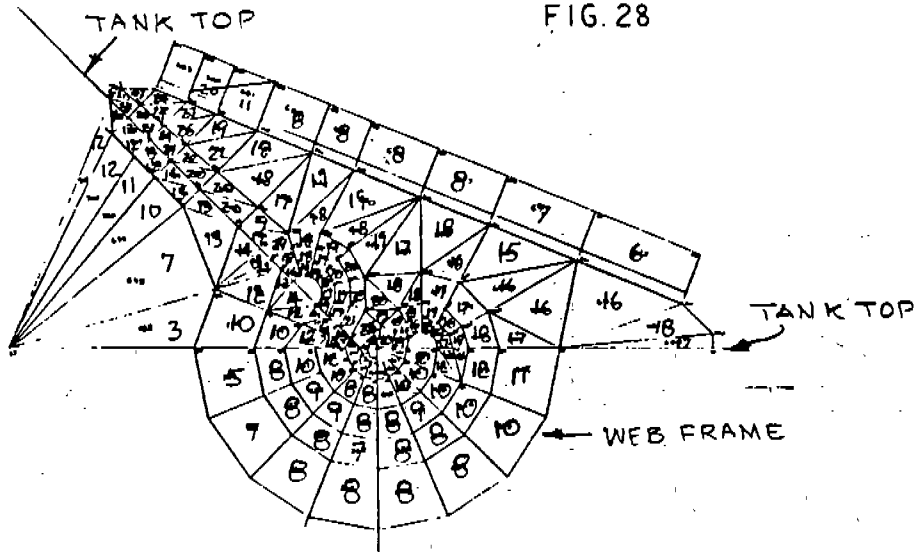

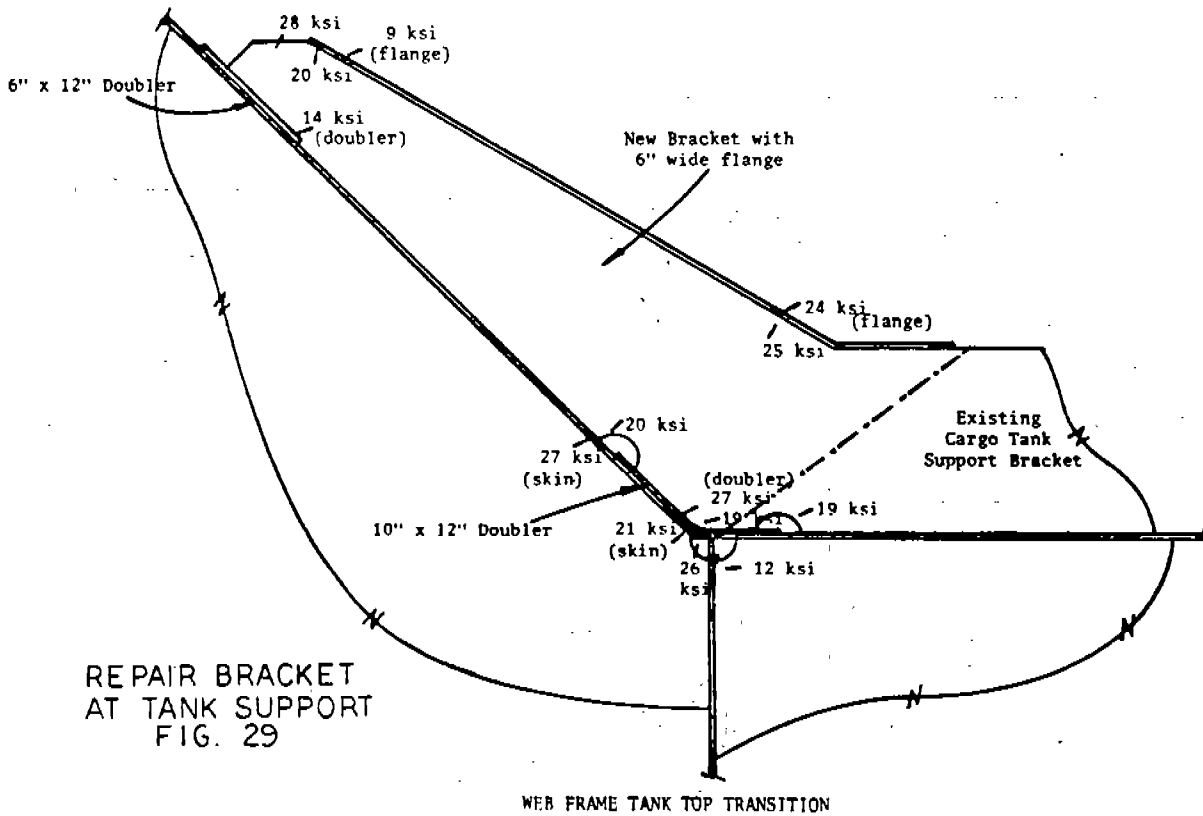
REPAIR BRACKET  
AT TANK SUPPORT  
FIG. 29

WEB FRAME TANK TOP TRANSITION



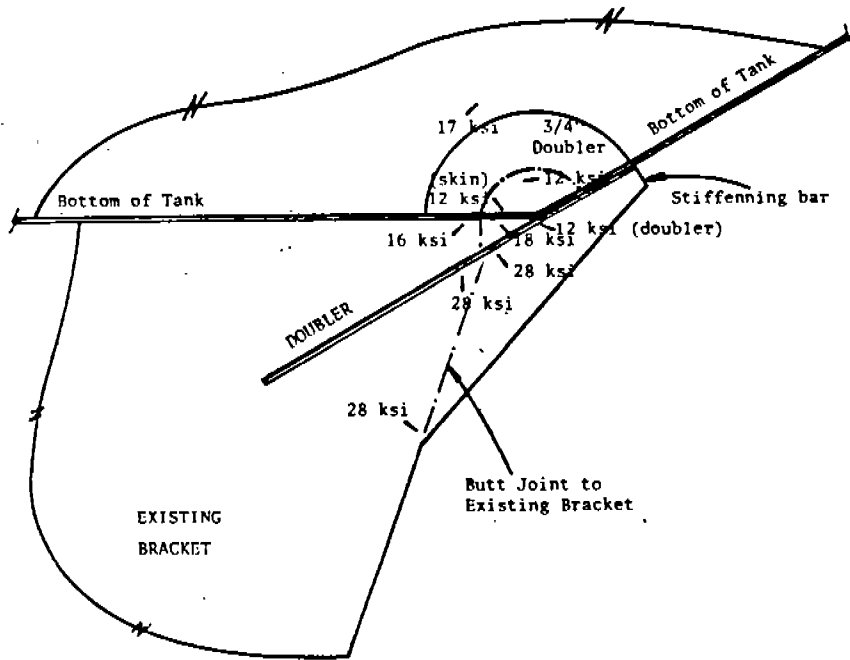

WEB FRAME TOP SADDLE TANK TRANSITION  
REPAIR STRUCTURE AT SADDLE TANK  
FIG. 31

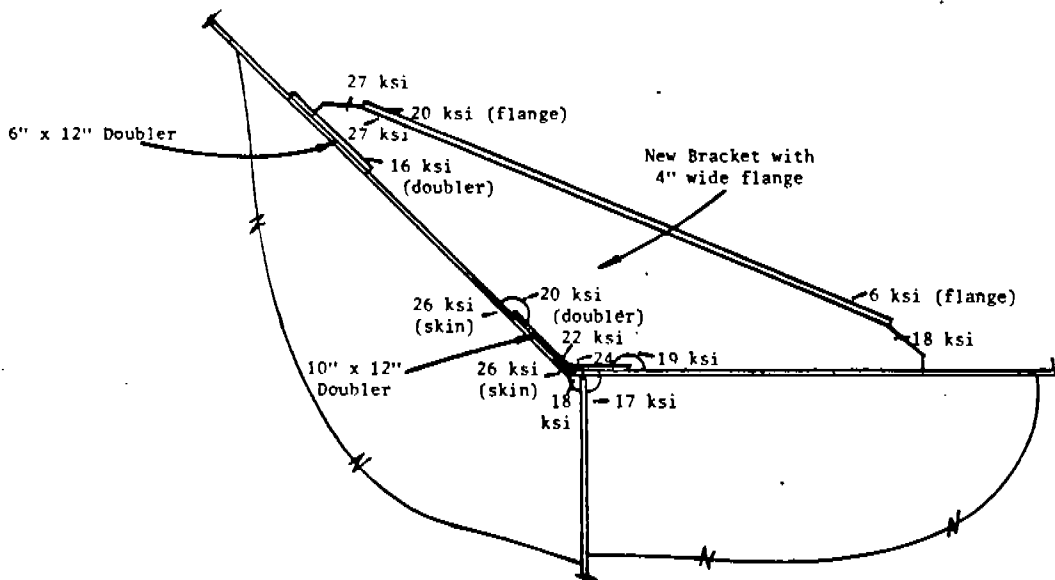

ORDINARY FRAME TANK TOP TRANSITION  
REPAIR BRACKET AT ORDINARY FRAME  
FIG. 30

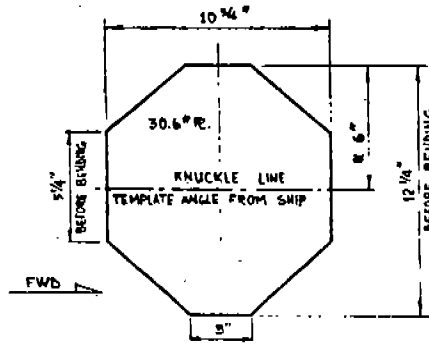
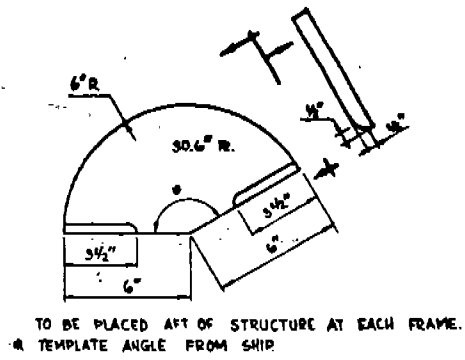
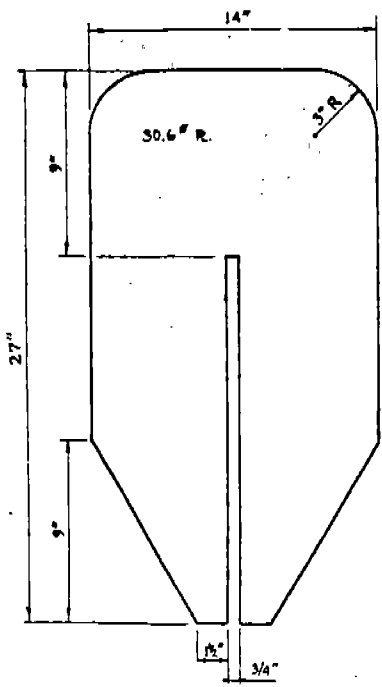

SADDLE TANK REINFORCING BRACKET  
FIGURE 32

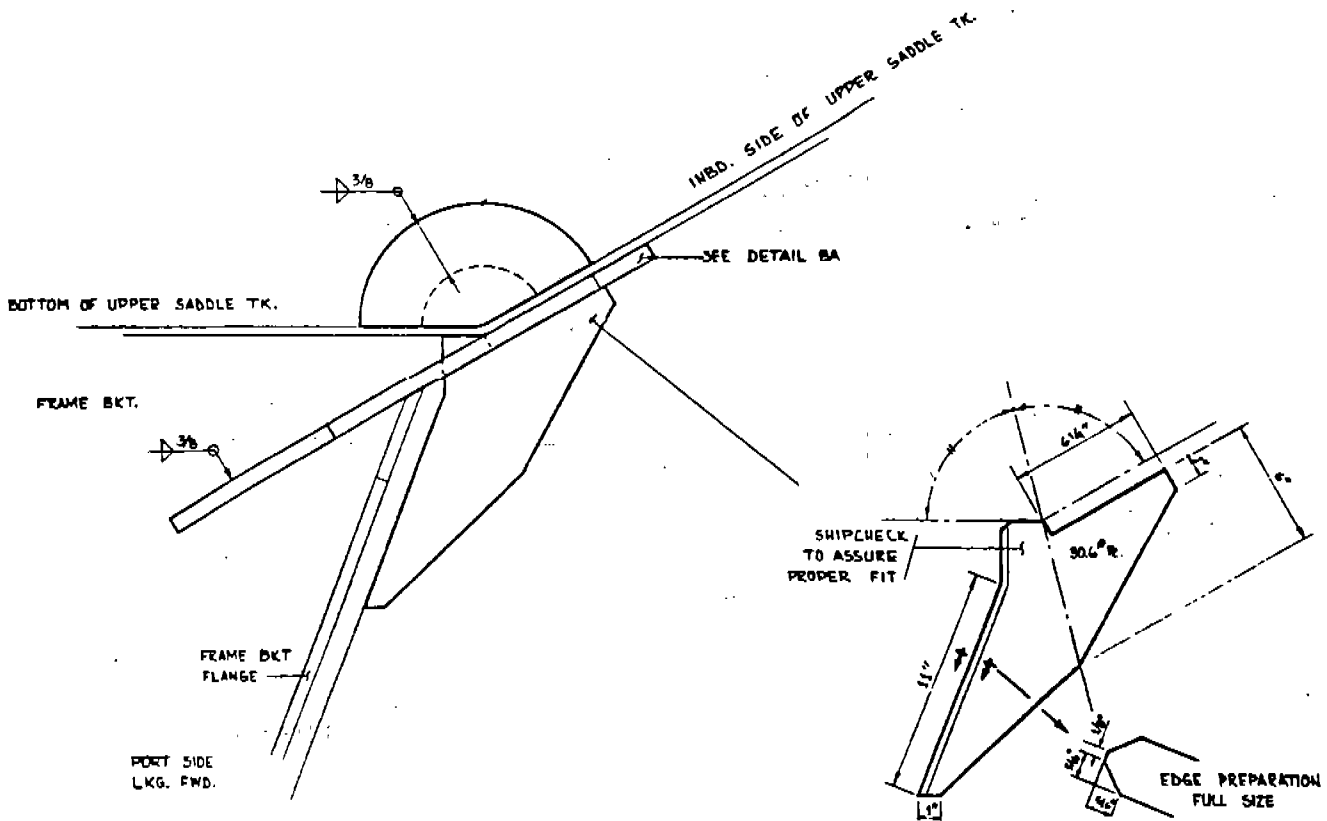

SADDLE TANK REINFORCEMENT BRACKET  
FIGURE 33

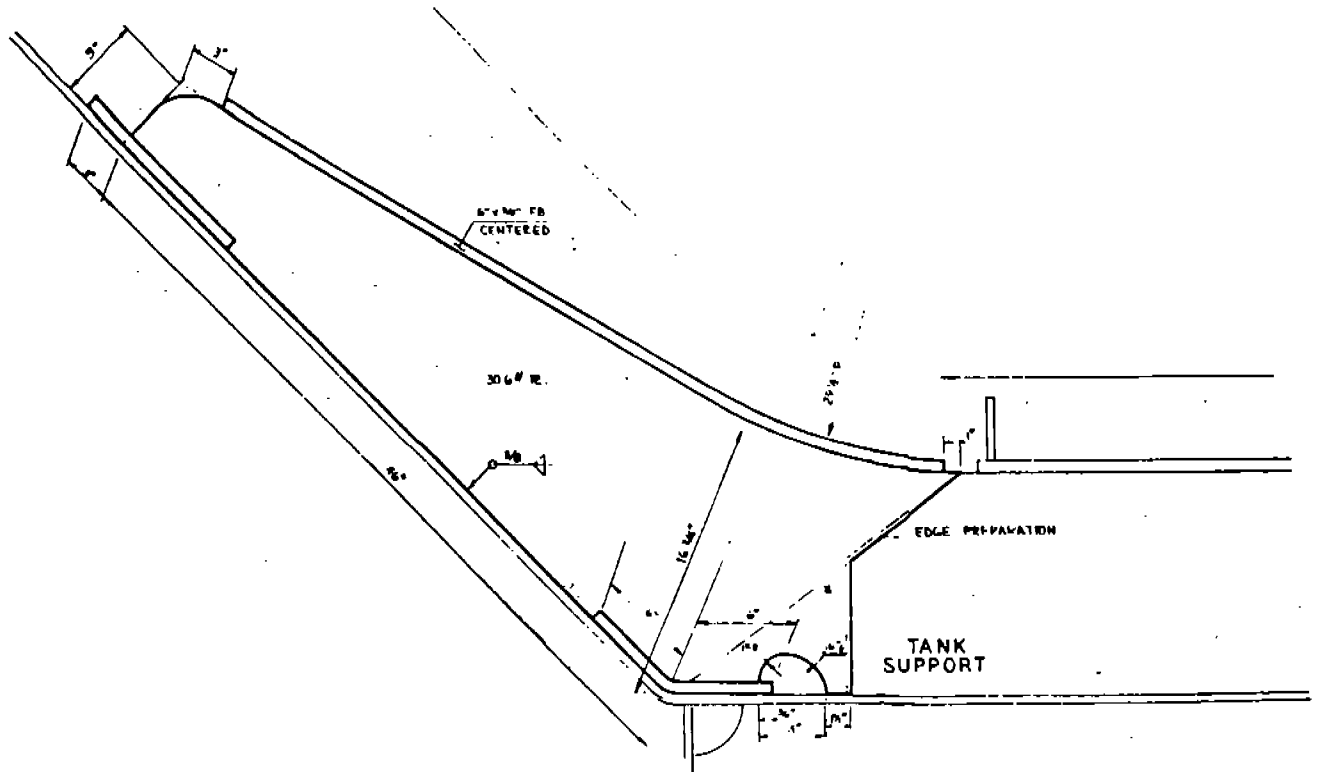

INNER BOTTOM KNUCKLE REINFORCEMENT  
FIGURE 34

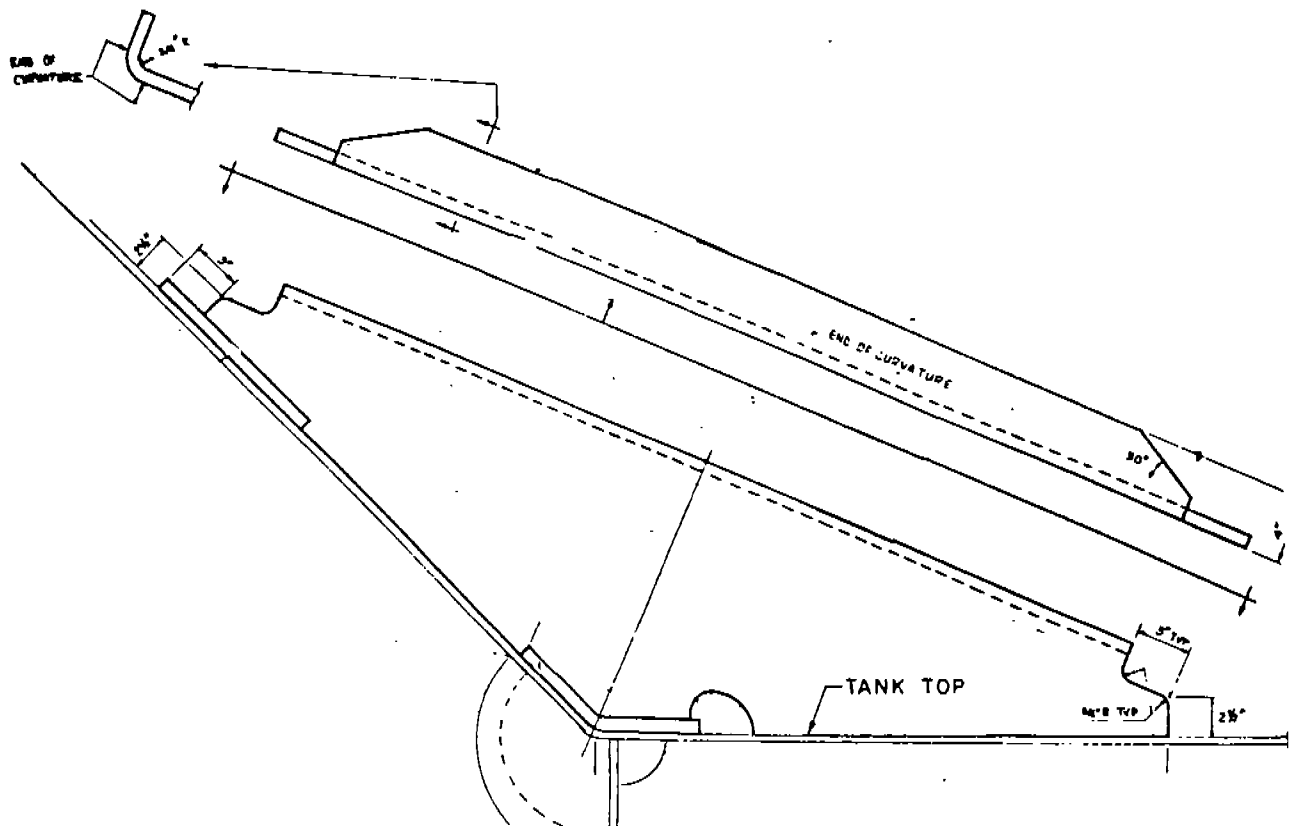

INNER BOTTOM KNUCKLE REINFORCEMENT  
FIGURE 35

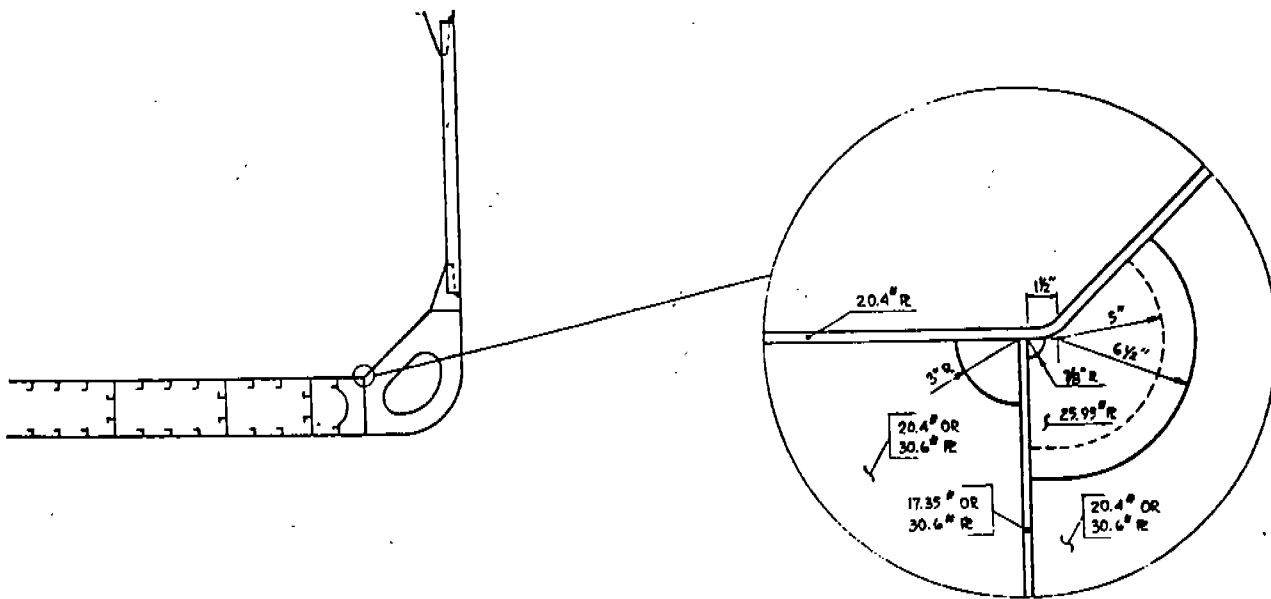

INNER BOTTOM KNUCKLE VENT CLOSING PLATE  
FIGURE 36

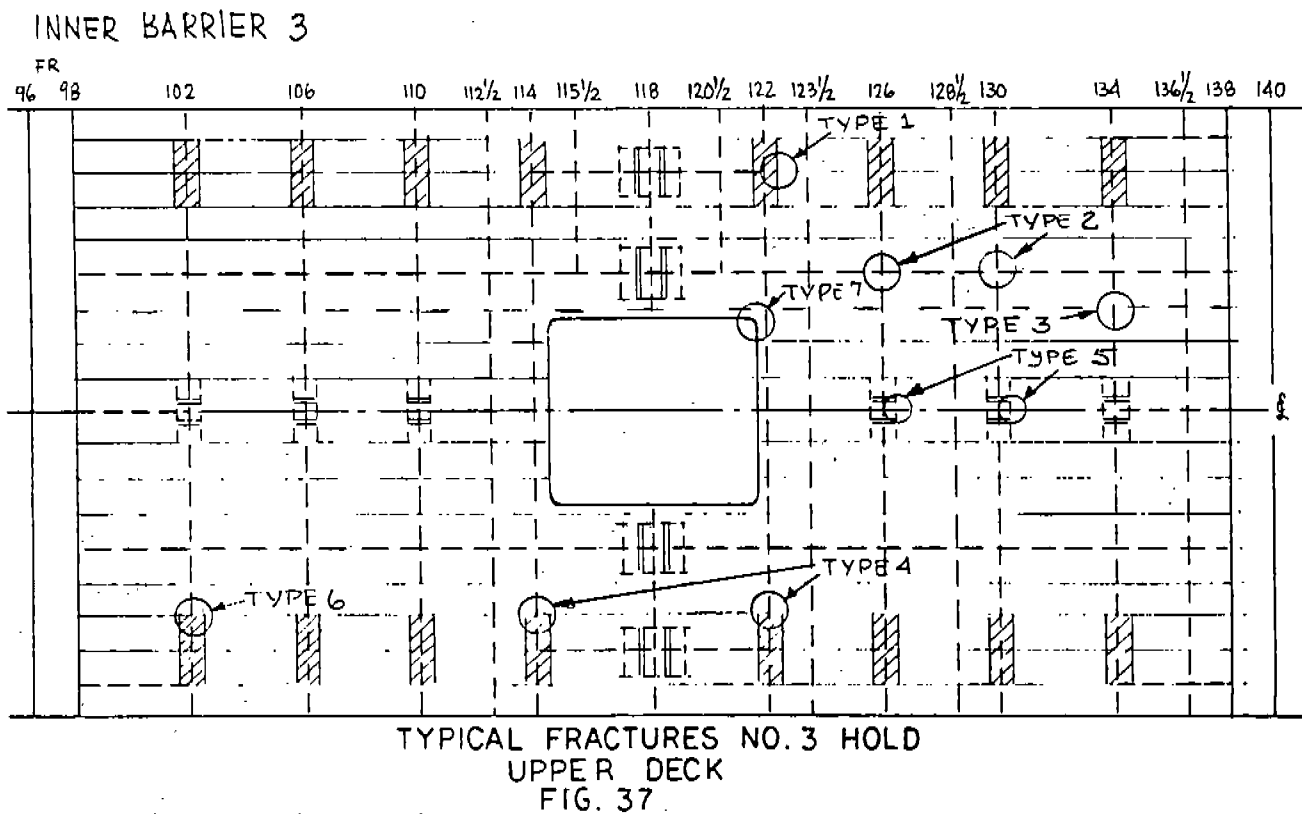

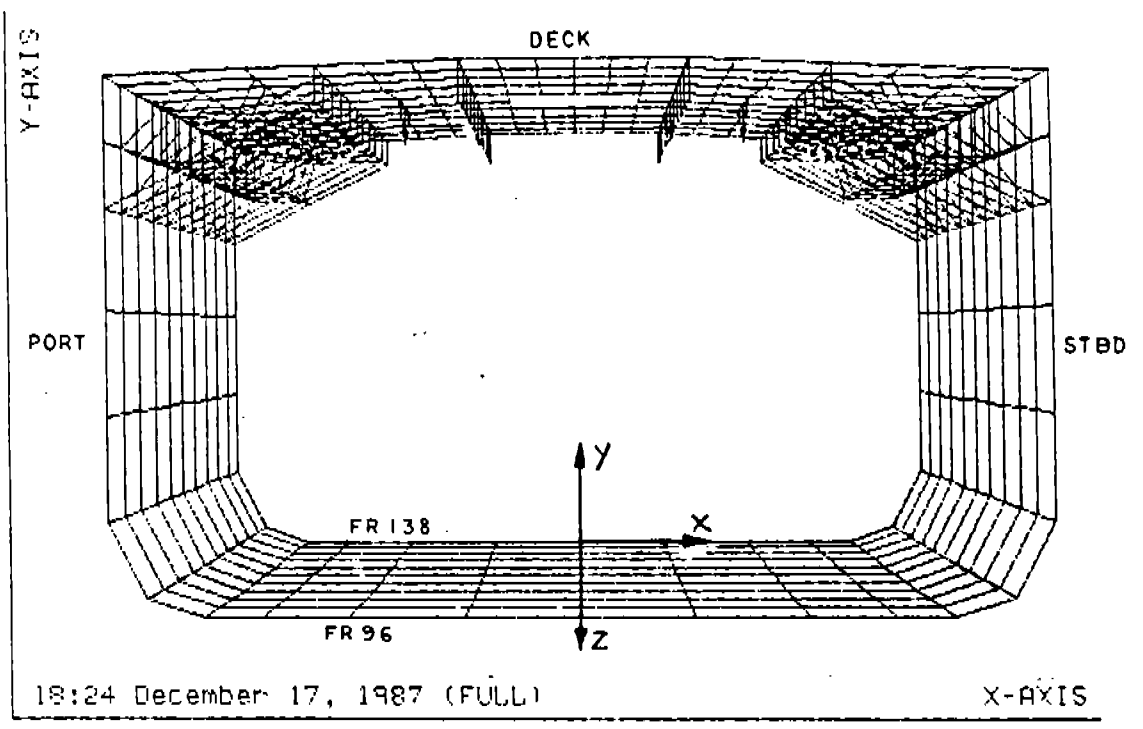

FIG. 38  
GLOBAL MODEL

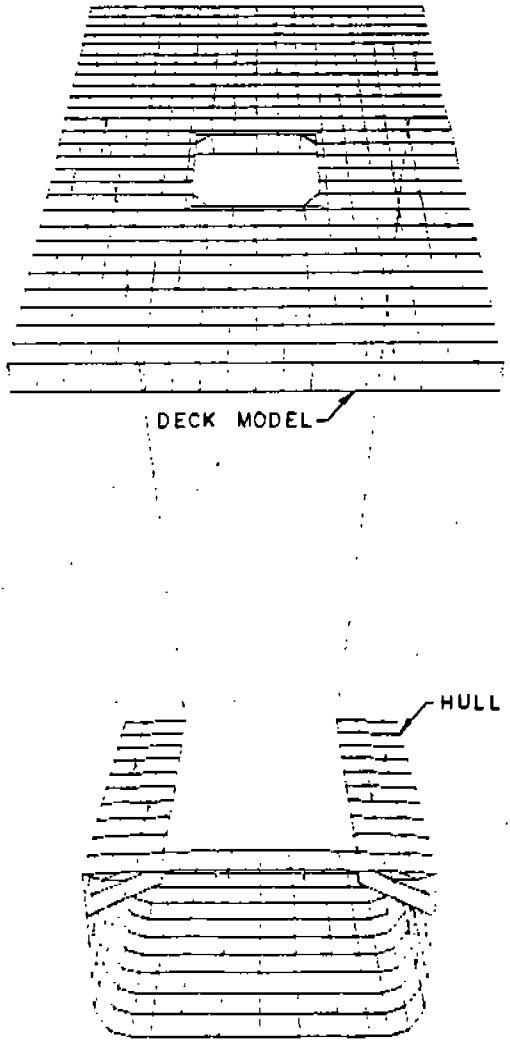

FIG. 39  
DECK MODEL

Fig. 40  
CORNER MODEL

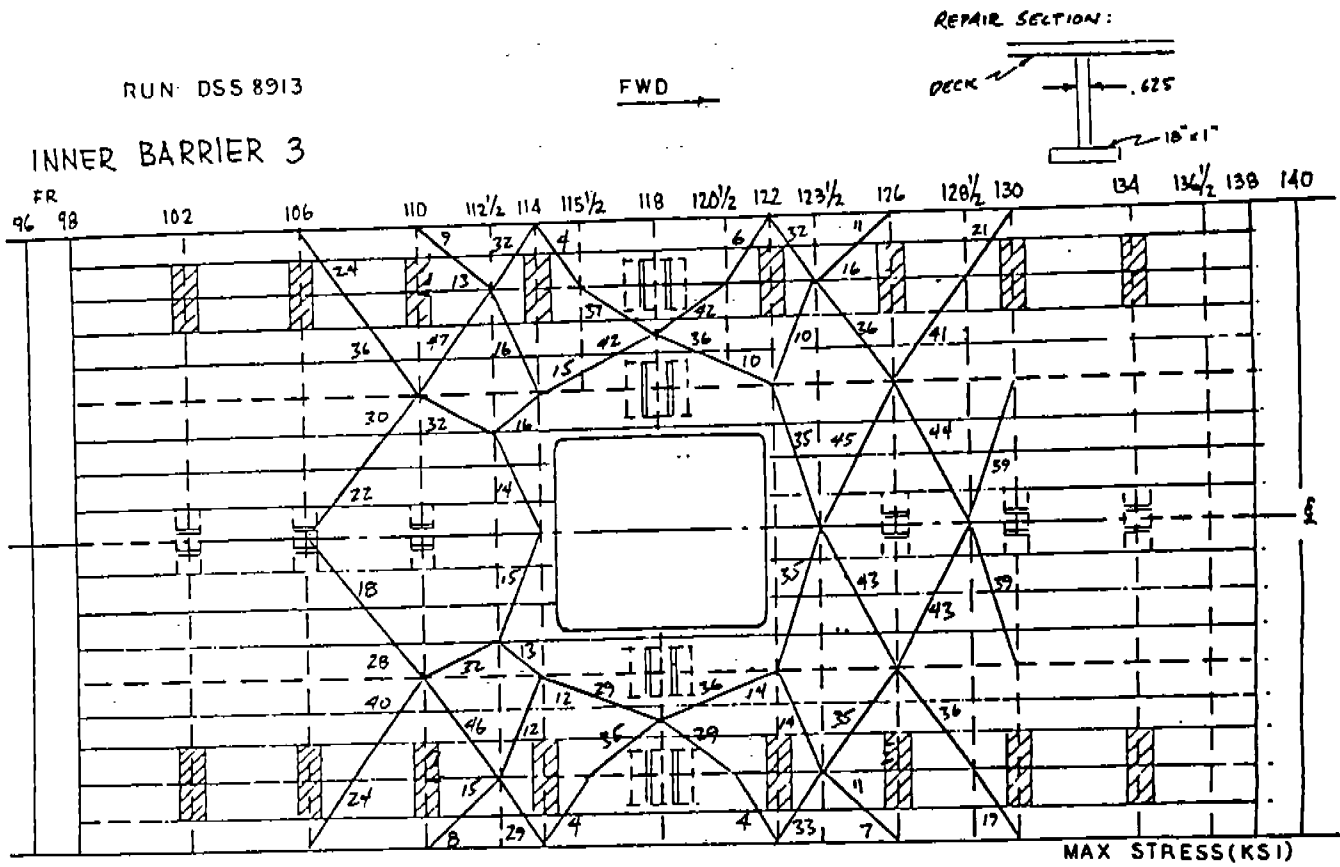
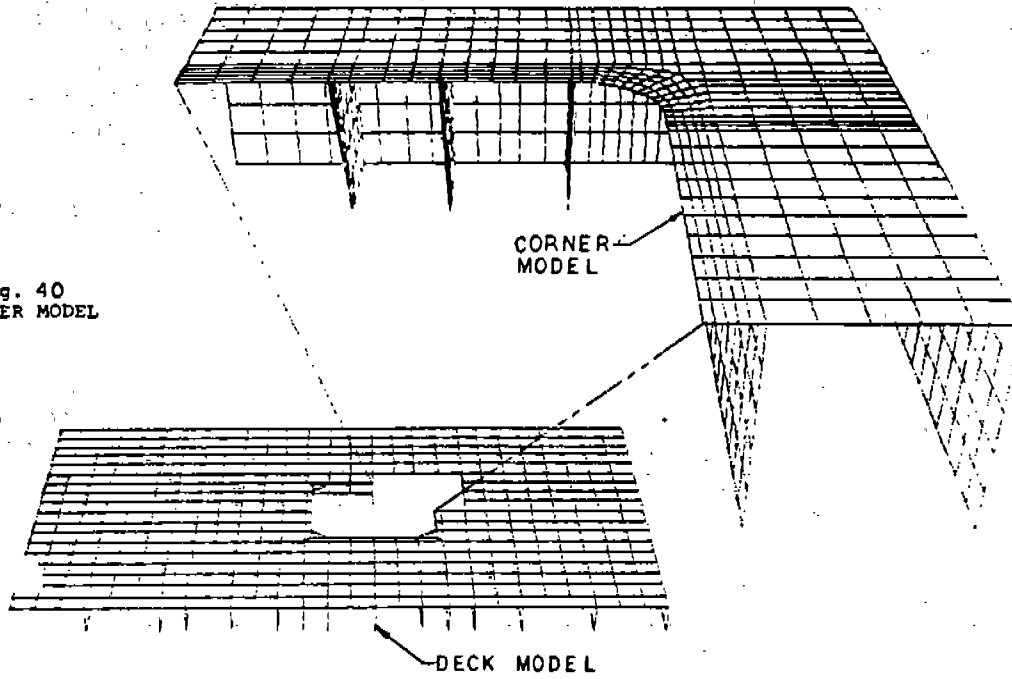

Fig. 41 Beam Stresses for Run# DSS8913

DECK PORT : LORD CASE 06, Run # F60120A  
 STRADINE VECTOR NO 1 MAX PRIM STRESS +X3 (TOP)

CONTOUR LEVELS  
 MIN -770.1  
 A -770.1  
 B 0.1336E+05  
 C 0.1737E+05  
 D 0.4144E+05  
 E 0.5551E+05  
 F 0.6959E+05  
 G 0.8366E+05  
 H 0.5773E+05  
 MAX 0.9773E+05

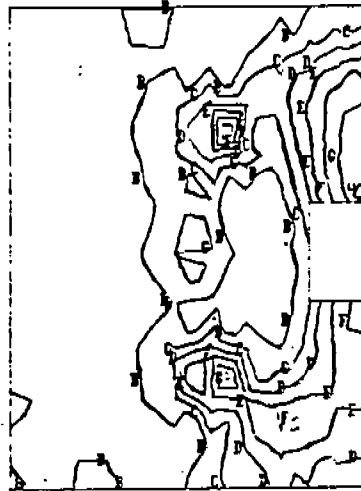

Fig. 42

UPPER DECK 1/2 PLAN BEFORE REPAIR

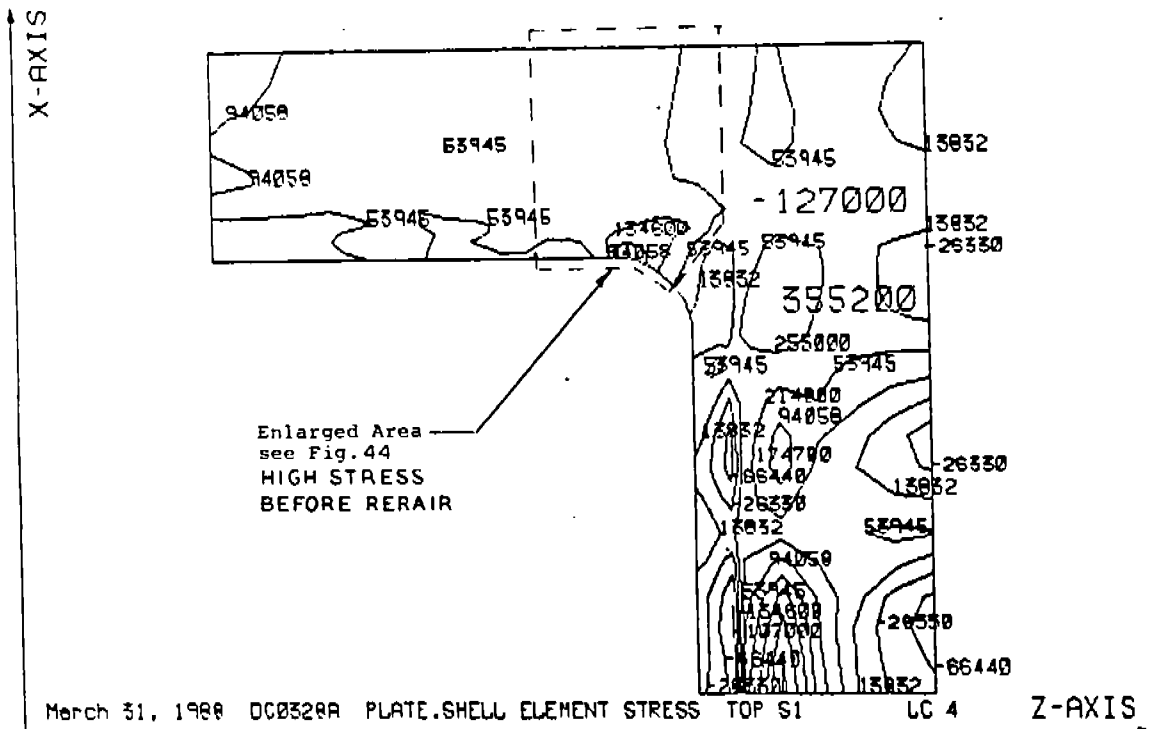
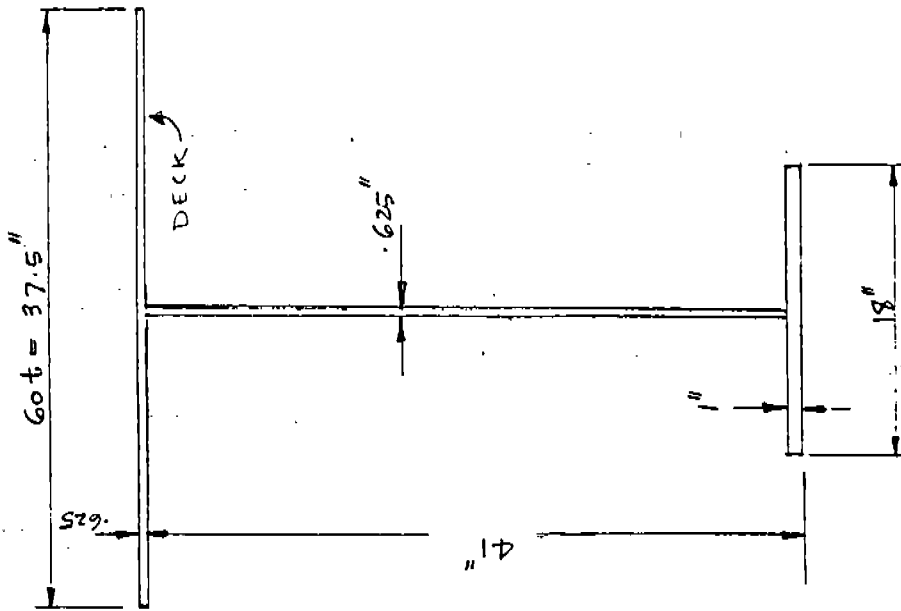

FIG. 43 PLAN UPPER DECK CORNER.









TYPICAL UNDER DECK DIAGONAL  
REPAIR GIRDERS  
FIG 49

BEFORE REPAIR  
STRESS SUMMARY  
(all stresses in KSI)

LOCATION	BOTTOM		TOP	
	MAX	MIN	MAX	MIN
DECK PLATING	43	-186	196	-22
LONGITUDINAL GIRDER	71	-84	92	-24
AUXILIARY WEB (123.5)	51	-109	124	-54
WEB FRAME (122)	28	-29	24	-22

AFTER REPAIR  
STRESS SUMMARY  
(all stresses in KSI)

LOCATION	BOTTOM		TOP	
	MAX	MIN	MAX	MIN
DECK PLATING	31	-23	33	-18
LONGITUDINAL GIRDER	55	-41	38	-44
AUXILIARY WEB (123.5)	39	-46	46	-46
WEB FRAME (122)	25	-18	23	-19
REPAIR GIRDER	31	-42	51	-22

FIG. 48 UPPER DECK STRESS ANALYSIS

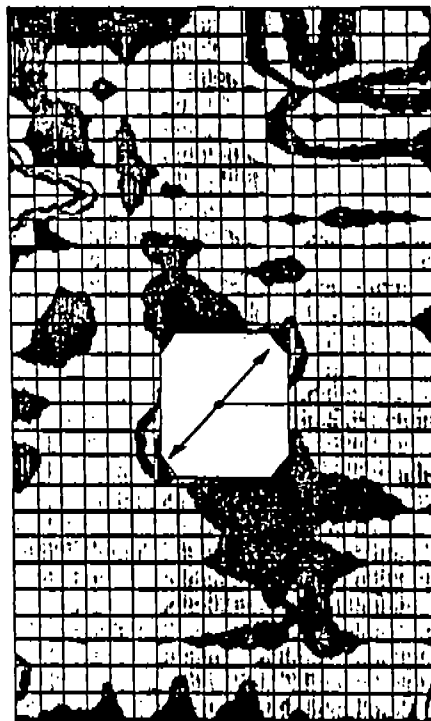

FR 138  
FWD

STRESS CONTOURS  
S1 PRINCPL STRESS  
VIEW : -3.29E+03  
RANGE : 2.99E+05

1.0E+01

40.00

35.19

30.38

25.57

20.76

15.95

11.14

6.327

1.516

-3.294

HIGH STRESS  
AT CORNERS  
+40 KSI

EMRC-NISA/DISPLAY

Y X RX= 90  
Z RY= 0  
RZ= 0

DS3B (EXISTING GLOBAL)  
PRINCIPAL STRESS

FIG.50  
PLAN VIEW-UPPER DECK  
WITHOUT REINFORCEMENT

FR 98  
AFT

24'-3"



FR 138  
FWD

STRESS CONTOURS  
S1 PRINCPL STRESS  
VIEW : -5.86E+03  
RANGE : 1.14E+05

1.0E+01

15.00

12.68

10.36

8.046

5.728

3.410

1.092

-1.225

-3.543

-5.861

REDUCED STRESS  
AFTER CORERS  
<15 KSI

EMRC-NISA/DISPLAY

Y X RX= 90  
Z RY= 0  
RZ= 0

DS90C (1990 REPAIR)  
PRINCIPAL STRESS

FIG.51  
PLAN VIEW-UPPER DECK  
AFTER REINFORCEMENT  
40" GIRDERS

FR 98

24'-3"

STRESS CONTOURS  
 S1 PRINCPL STRESS  
 VIEW : -3.29E+03  
 RANGE : 2.99E+05

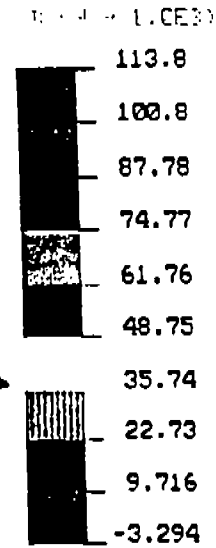
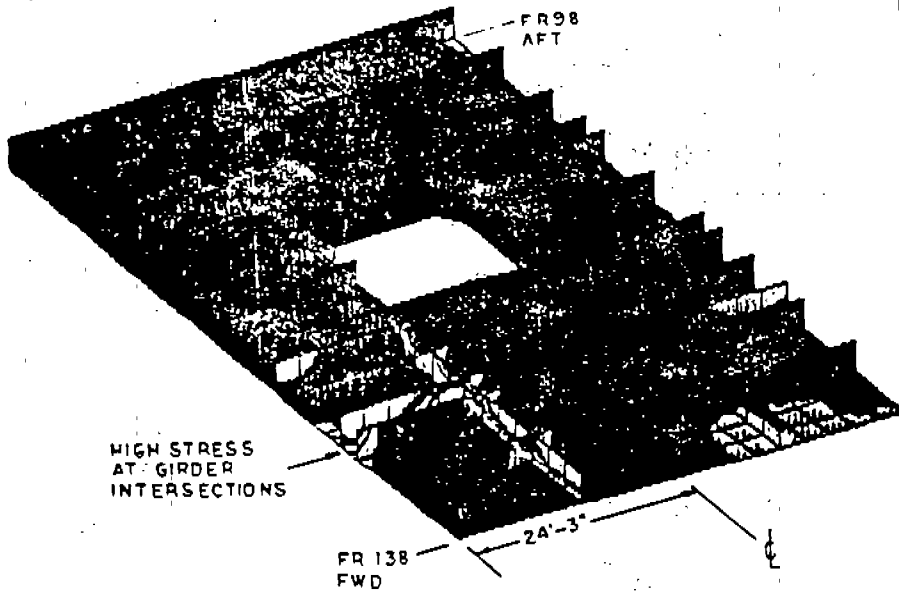

EMRC-NISA/DISPLAY

Z X  
 Y RX= 30  
 RY= 210  
 RZ= 180

DS3B (EXISTING GLOBAL)  
 PRINCIPAL STRESS

FIG. 52  
 VIEW OF UNDERSIDE  
 OF UPPER DECK  
 PRIOR TO REINFORCEMENT

STRESS CONTOURS  
 S1 PRINCPL STRESS  
 VIEW : -5.86E+03  
 RANGE : 1.14E+05

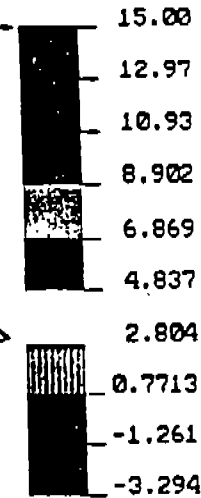
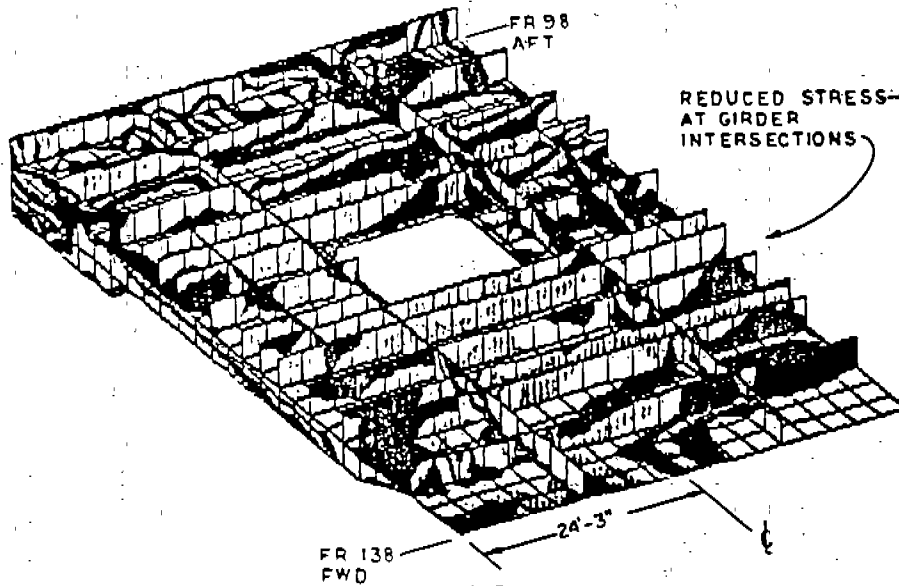

EMRC-NISA/DISPLAY

Z X  
 Y RX= 30  
 RY= 210  
 RZ= 180

DS900 (1990 REPAIR)  
 PRINCIPAL STRESS

FIG. 53  
 VIEW OF UNDERSIDE  
 OF UPPER DECK  
 AFTER REINFORCEMENT  
 40" GIRDERS

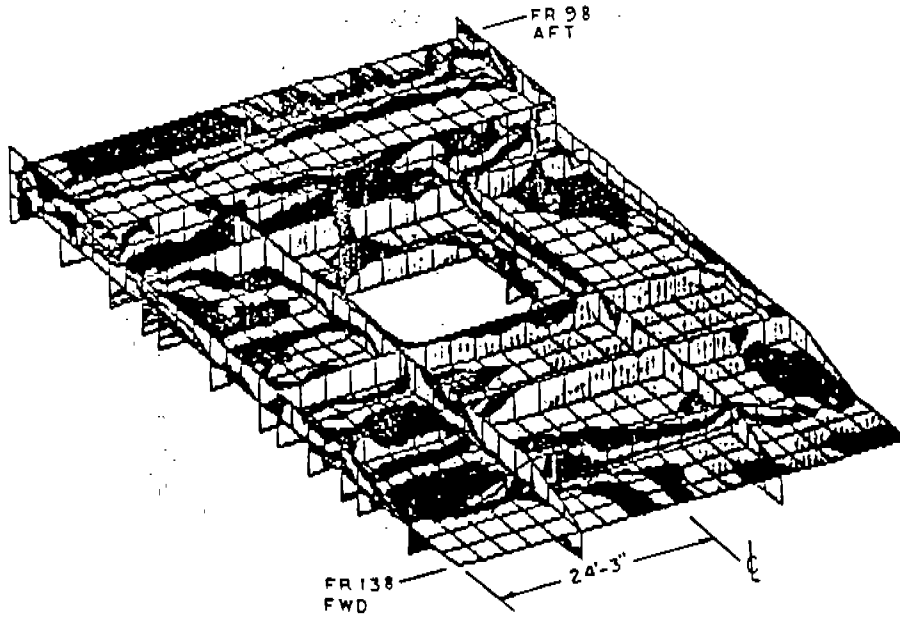

STRESS CONTOURS  
 S1 PRINCPL STRESS  
 VIEW : -5.86E+03  
 RANGE : 1.14E+05

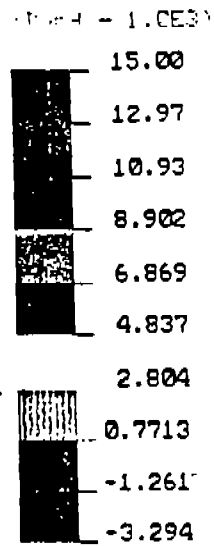

EMRC-NISA/DISPLAY

X  
 Y  
 Z  
 RX= 30  
 RY= 210  
 RZ= 0

FIG. 54

VIEW OF TOP-UPPER DECK  
 AFTER REINFORCEMENT  
 40" GIRDERS

DS900 (1992 REPAIR)  
 PRINCIPAL STRESS

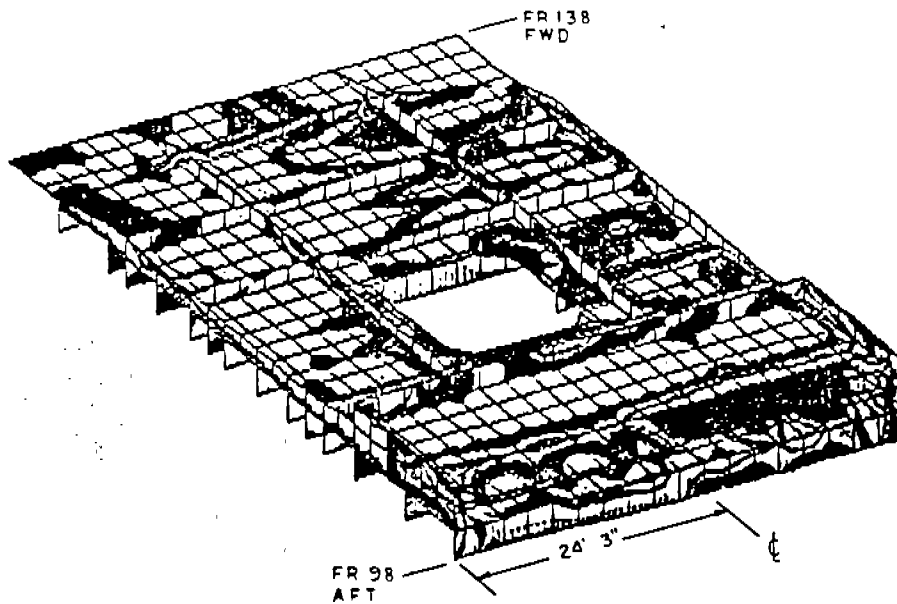

STRESS CONTOURS  
 S1 PRINCPL STRESS  
 VIEW : -3.76E+03  
 RANGE : 9.80E+04

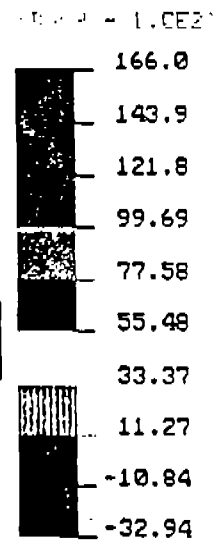

EMRC-NISA/DISPLAY

X  
 Y  
 Z  
 RX= 30  
 RY= 30  
 RZ= 0

FIG. 55  
 VIEW OF TOP UPPER DECK  
 AFTER REINFORCEMENT  
 24" GIRDERS

DS901 ( 24" STIFFENER WITH 12" FLANGE )  
 PRINCIPAL STRESS

STRESS CONTOURS  
 S1 PRINCPL STRESS  
 VIEW : -1.94E+04  
 RANGE : 2.36E+05

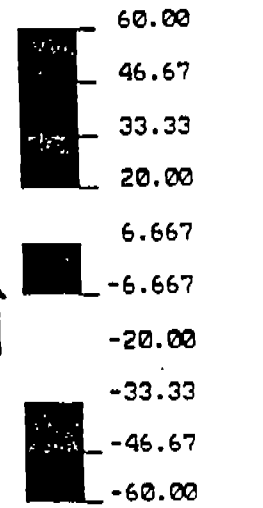
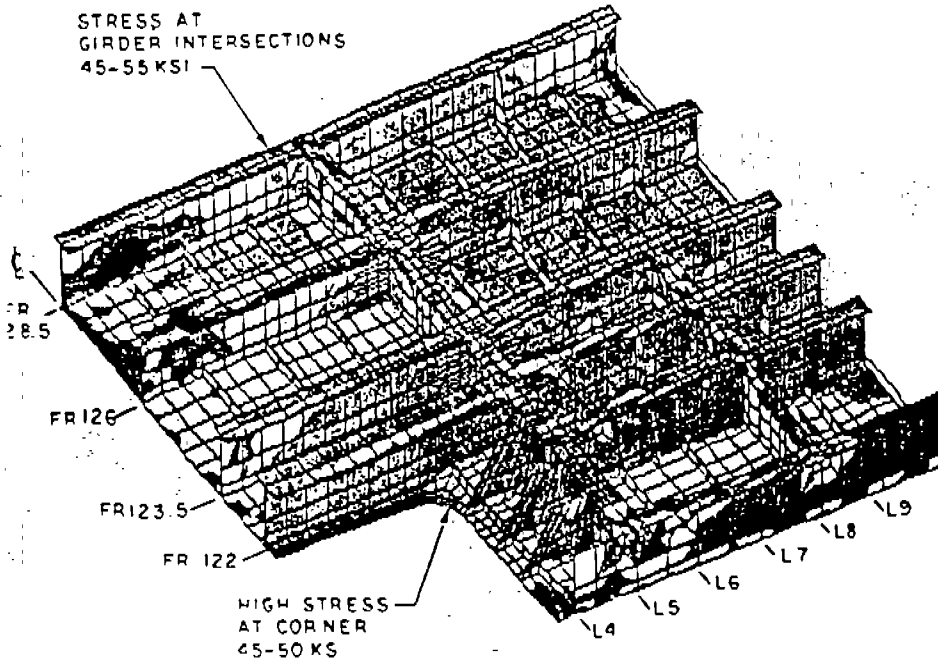

EMRC-NISA/DISPLAY

ORIGINAL 1990 REPAIR  
 PRINCIPAL STRESS

FIG. 58  
 VIEW OF UNDER SIDE OF UPPER DECK  
 PRIOR TO REINFORCEMENT

RX= 45  
 RY= 30  
 RZ= 180

STRESS CONTOURS  
 S1 PRINCPL STRESS  
 VIEW : -2.63E+04  
 RANGE : 2.36E+05

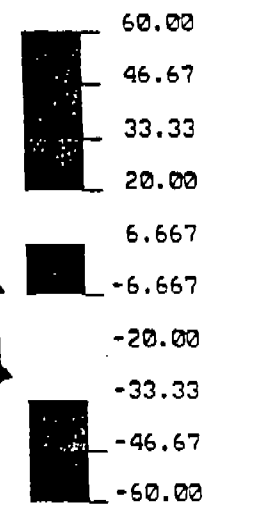
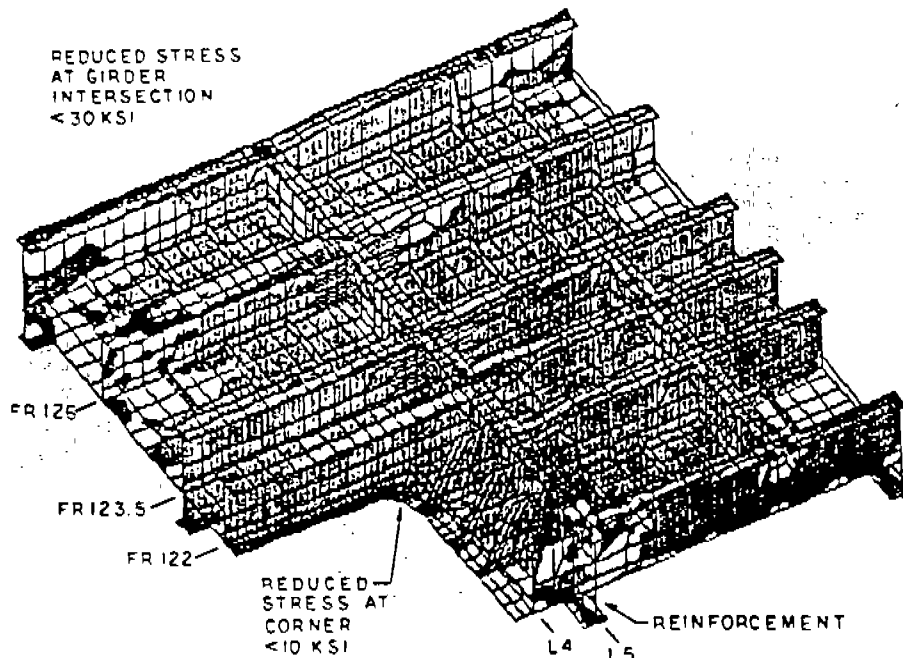

EMRC-NISA/DISPLAY

1990 (1990 REPAIR)  
 PRINCIPAL STRESS

FIG. 59  
 VIEW OF UNDER SIDE OF UPPER DECK  
 AFTER REINFORCEMENT  
 24" GIRDERS

RX= 45  
 RY= 30  
 RZ= 180

STRESS CONTOURS  
 S1 PRINCPL STRESS  
 VIEW : -2.36E+03  
 RANGE : 6.90E+04

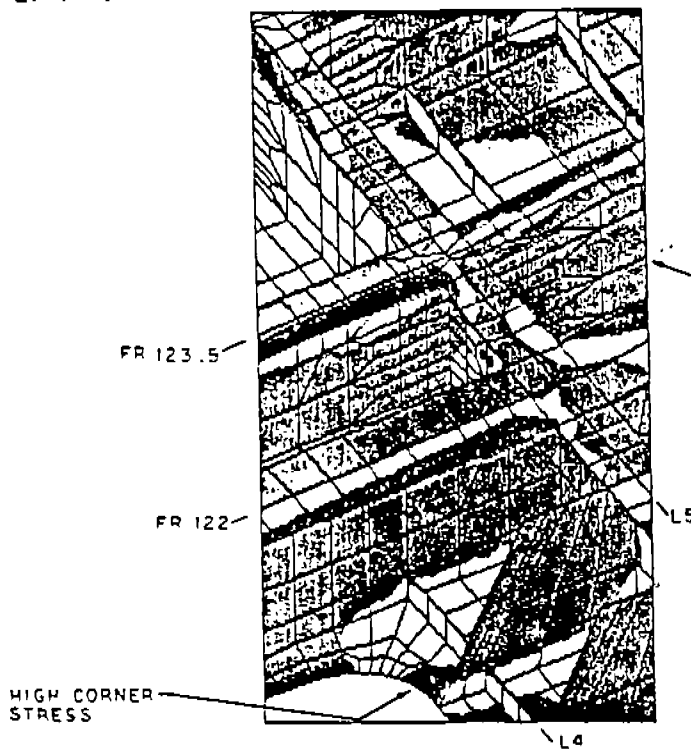

HIGH STRESS  
 AT GIRDER  
 INTERSECTION

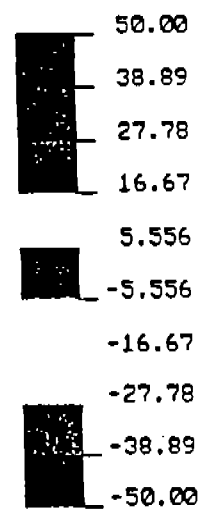

EMRC-NISA/DISPLAY

RX= 45  
 RY= 30  
 RZ= 180

ORIGINAL ( NO REPAIR )  
 PRINCIPAL STRESS  
 FIG. 60  
 VIEW OF UNDER SIDE OF UPPER  
 DECK PRIOR TO REINFORCEMENT

STRESS CONTOURS  
 S1 PRINCPL STRESS  
 VIEW : -1.12E+03  
 RANGE : 3.96E+04

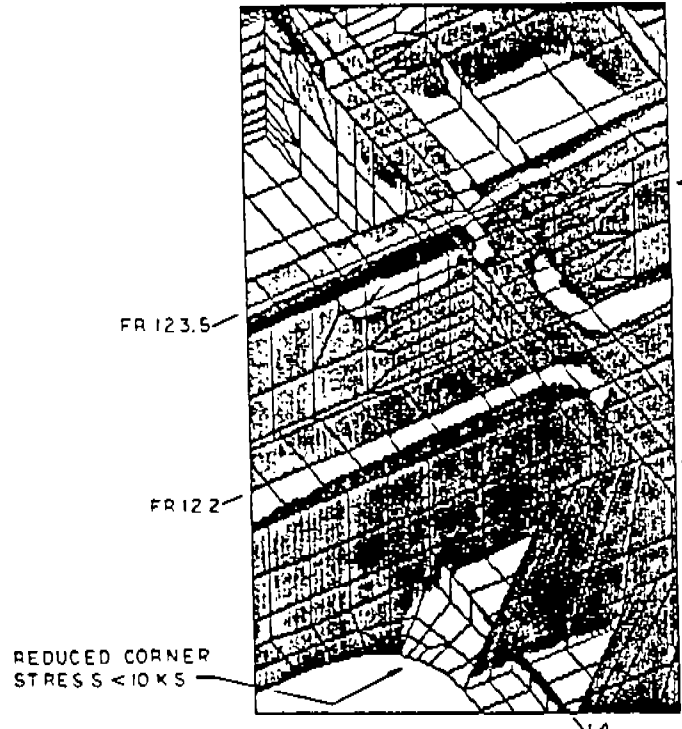

REDUCED  
 STRESS AT  
 INTERSECTION



EMRC-NISA/DISPLAY

RX= 45  
 RY= 30  
 RZ= 180

LOCAL ( 1992 REPAIR )  
 PRINCIPAL STRESS  
 FIG. 61  
 VIEW OF UNDER SIDE OF UPPER DECK  
 AFTER REINFORCEMENT





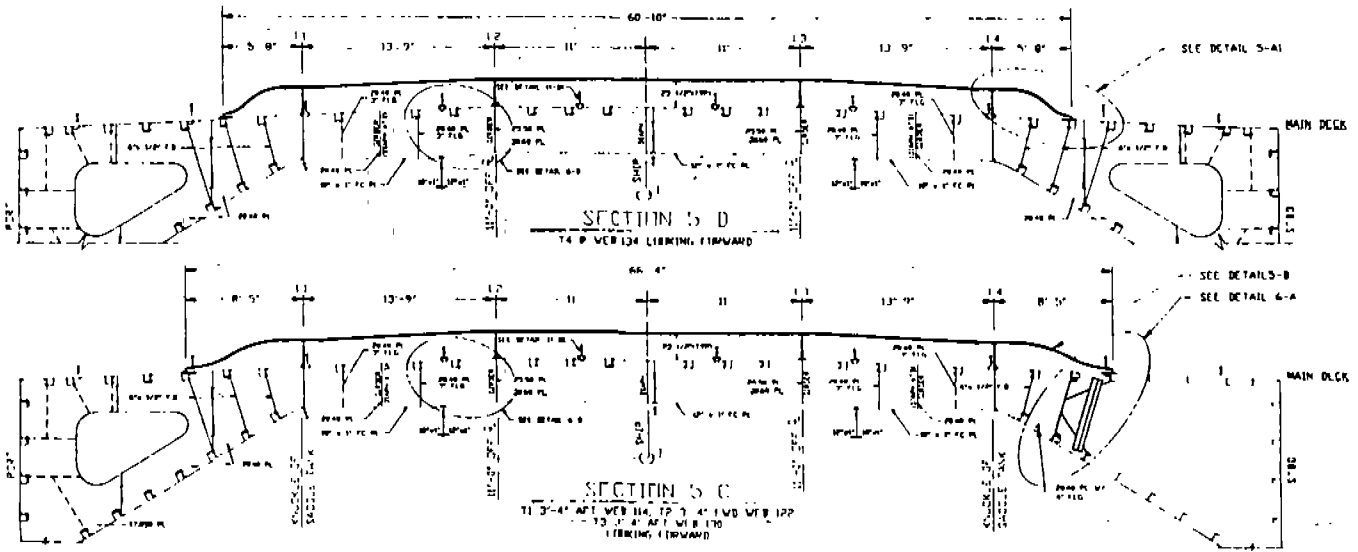

TRANSVERSE REPAIR GIRDERS  
FIG. 64

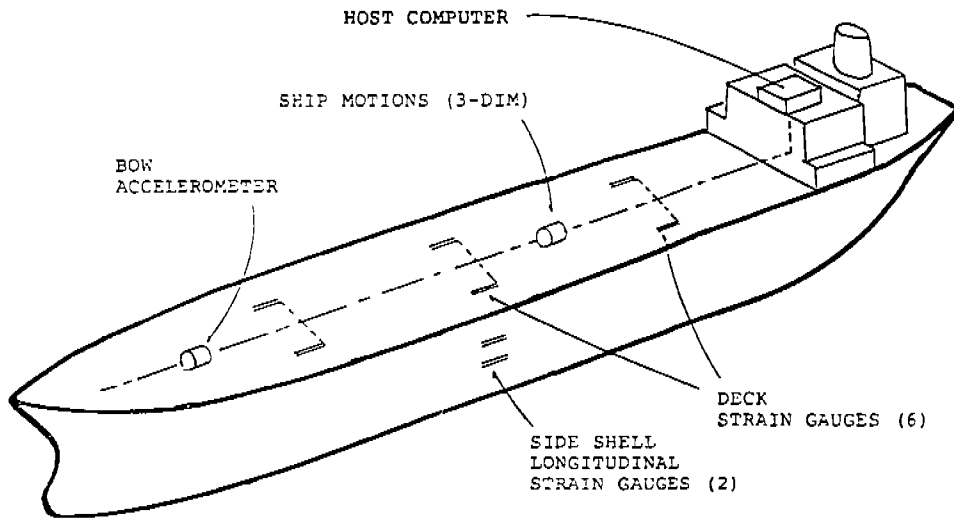

FIG. 65 SENSOR CONFIGURATION

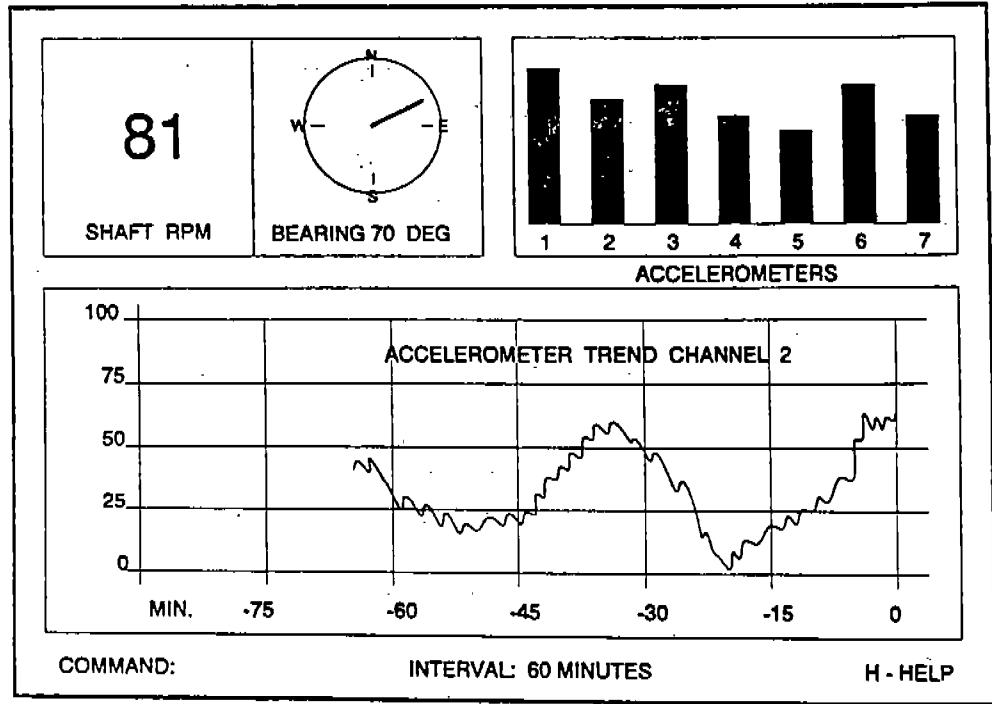

FIG. 66 DISPLAY ON THE VGA MONITOR